

US00D536979S

(12) **United States Design Patent**  
**Caserta et al.**

(10) **Patent No.:** **US D536,979 S**

(45) **Date of Patent:** **\*\* Feb. 20, 2007**

(54) **CONTAINER**

(75) Inventors: **Andrea Caserta**, Barcelona (ES);  
**Ruben Garcia Fabrega**, Barcelona  
(ES); **Fernando Mayor Sans**,  
Barcelona (ES)

(73) Assignee: **Zobebe Espana S.A.**, Barcelona (ES)

(\*\*) Term: **14 Years**

(21) Appl. No.: **29/244,492**

(22) Filed: **Dec. 9, 2005**

(51) **LOC (8) Cl.** ..... **09-01**

(52) **U.S. Cl.** ..... **D9/522; D9/523; D9/575**

(58) **Field of Classification Search** ..... D9/682,  
D9/686-689, 693-694, 723-725, 727-729,  
D9/763-764, 770, 521-523, 526-530, 537-545,  
D9/547-549, 551-552, 556, 558, 561, 563-565,  
D9/569, 571-575, 452-454; 215/382-384,  
215/396, 398; 220/660, 669, 675; 222/210,  
222/212-213; D23/356-359

See application file for complete search history.

(56) **References Cited**

**U.S. PATENT DOCUMENTS**

D160,209 S \* 9/1950 Piccoli ..... D9/571  
5,647,053 A \* 7/1997 Schroeder et al. .... 392/390  
D444,220 S \* 6/2001 Basaganas ..... D23/366

D452,732 S \* 1/2002 Basaganas ..... D23/366  
D475,774 S \* 6/2003 Millan ..... D23/366  
D476,895 S \* 7/2003 Fellows et al. .... D9/516  
D479,804 S \* 9/2003 Wolpert et al. .... D9/574  
6,659,301 B2 \* 12/2003 Fellows et al. .... 215/382 X  
D503,621 S \* 4/2005 Heater ..... D9/522  
D505,330 S \* 5/2005 Wolpert ..... D9/522  
D518,730 S \* 4/2006 Caserta et al. .... D9/522  
2002/0172512 A1 \* 11/2002 Stathakis et al. .... 392/395

\* cited by examiner

*Primary Examiner*—Carol Rademaker

(74) *Attorney, Agent, or Firm*—Knobbe Martens Olson &  
Bear LLP

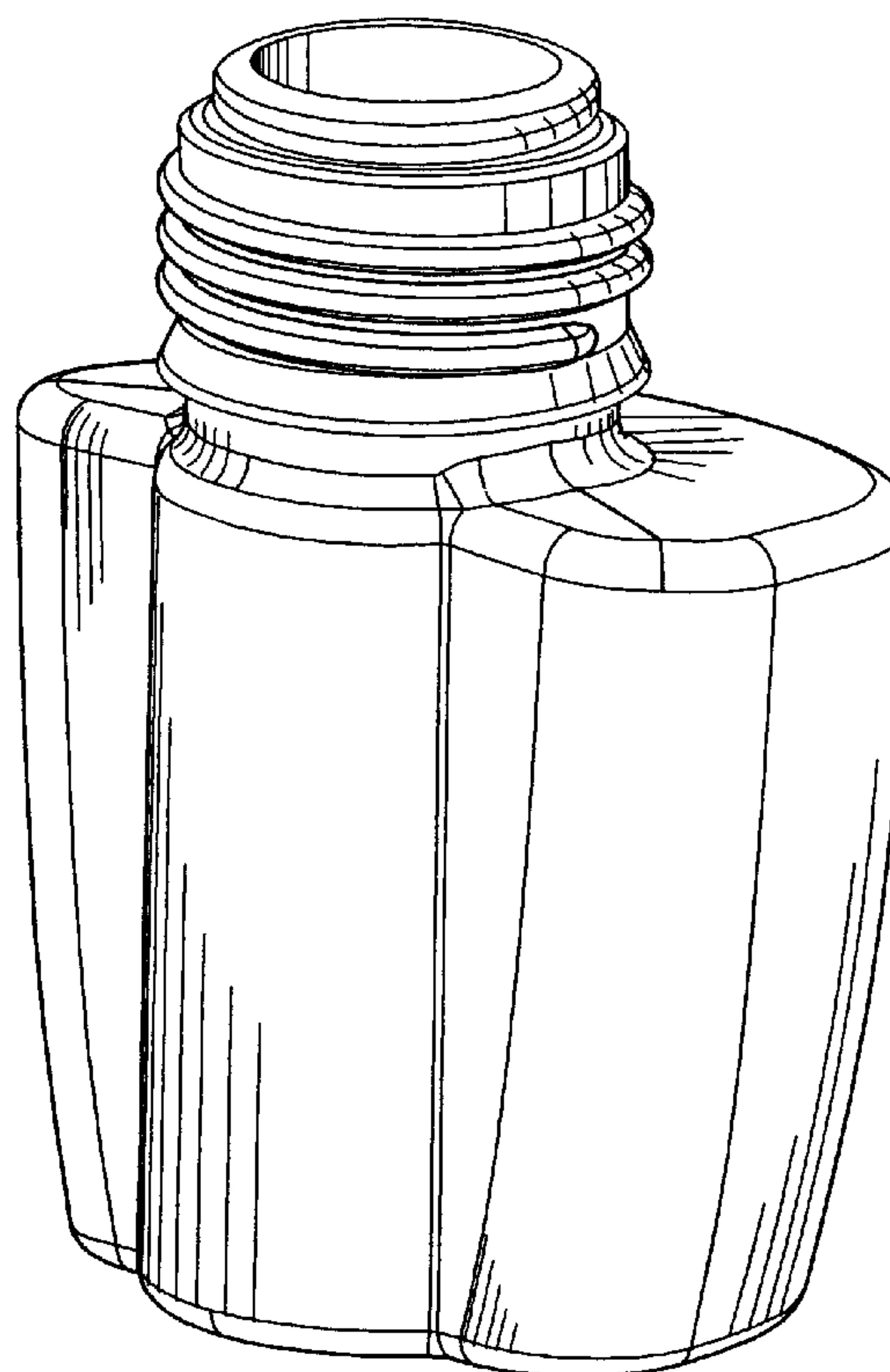
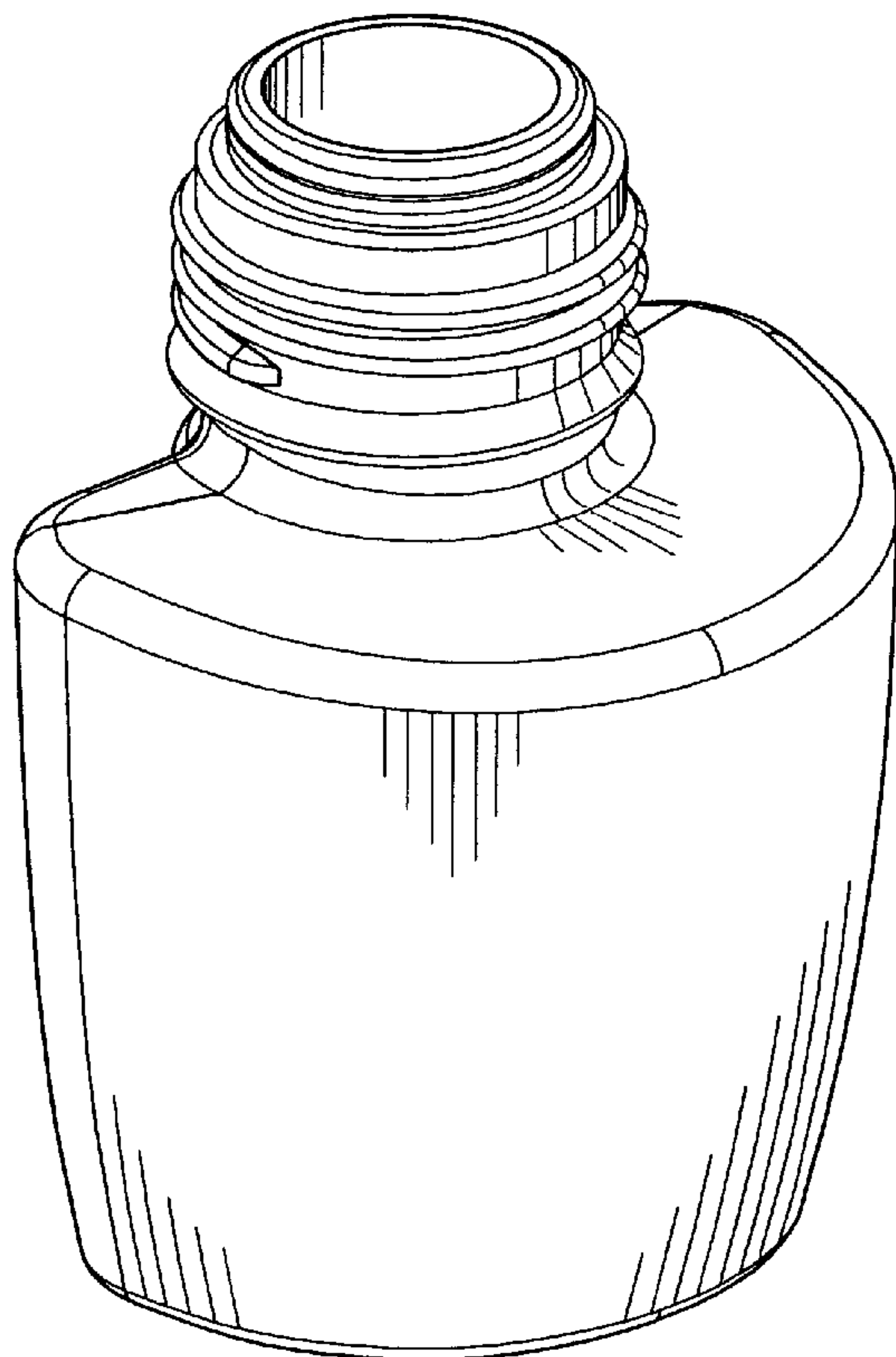
(57) **CLAIM**

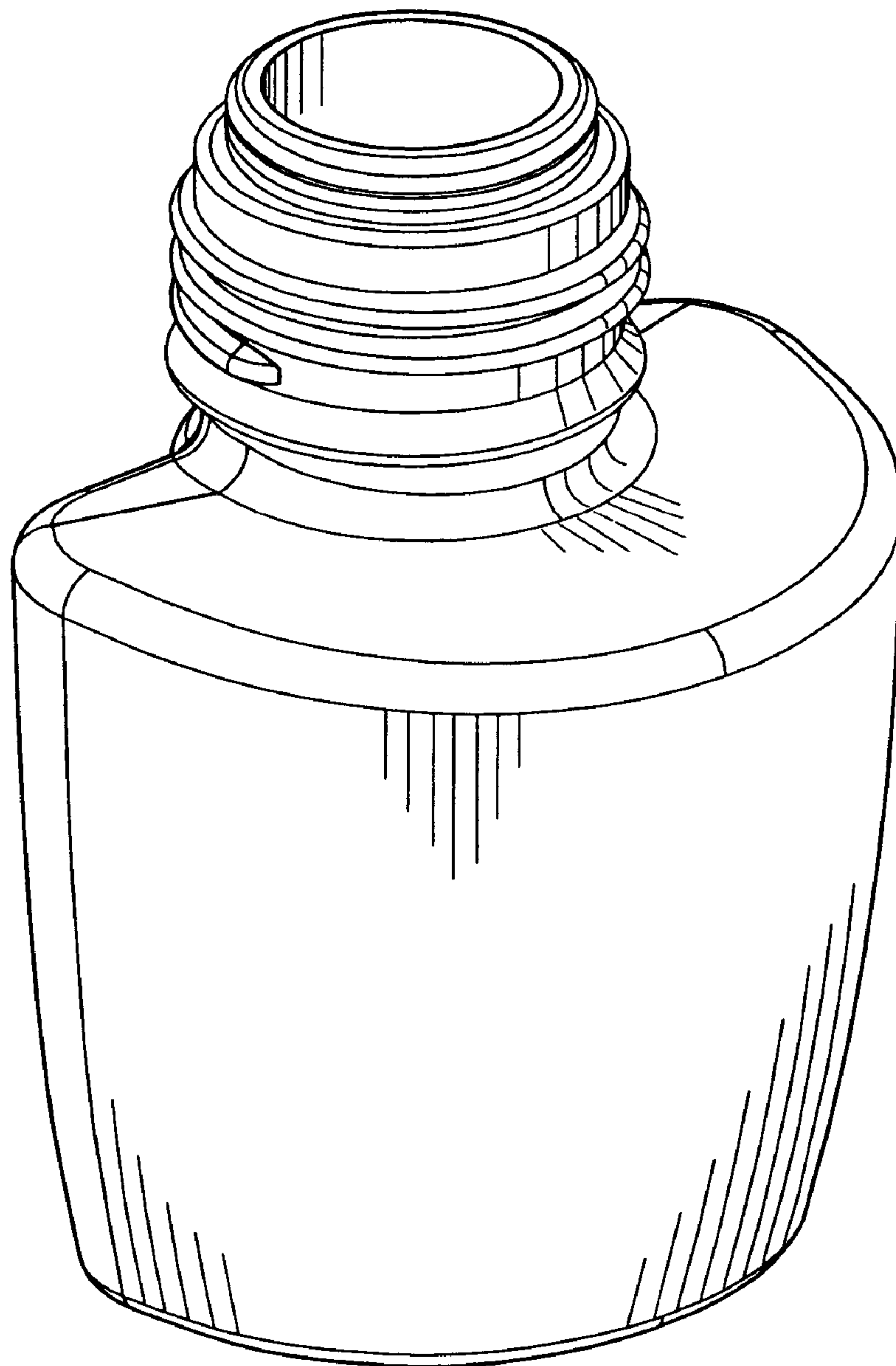
The ornamental design for an container, as shown and  
described.

**DESCRIPTION**

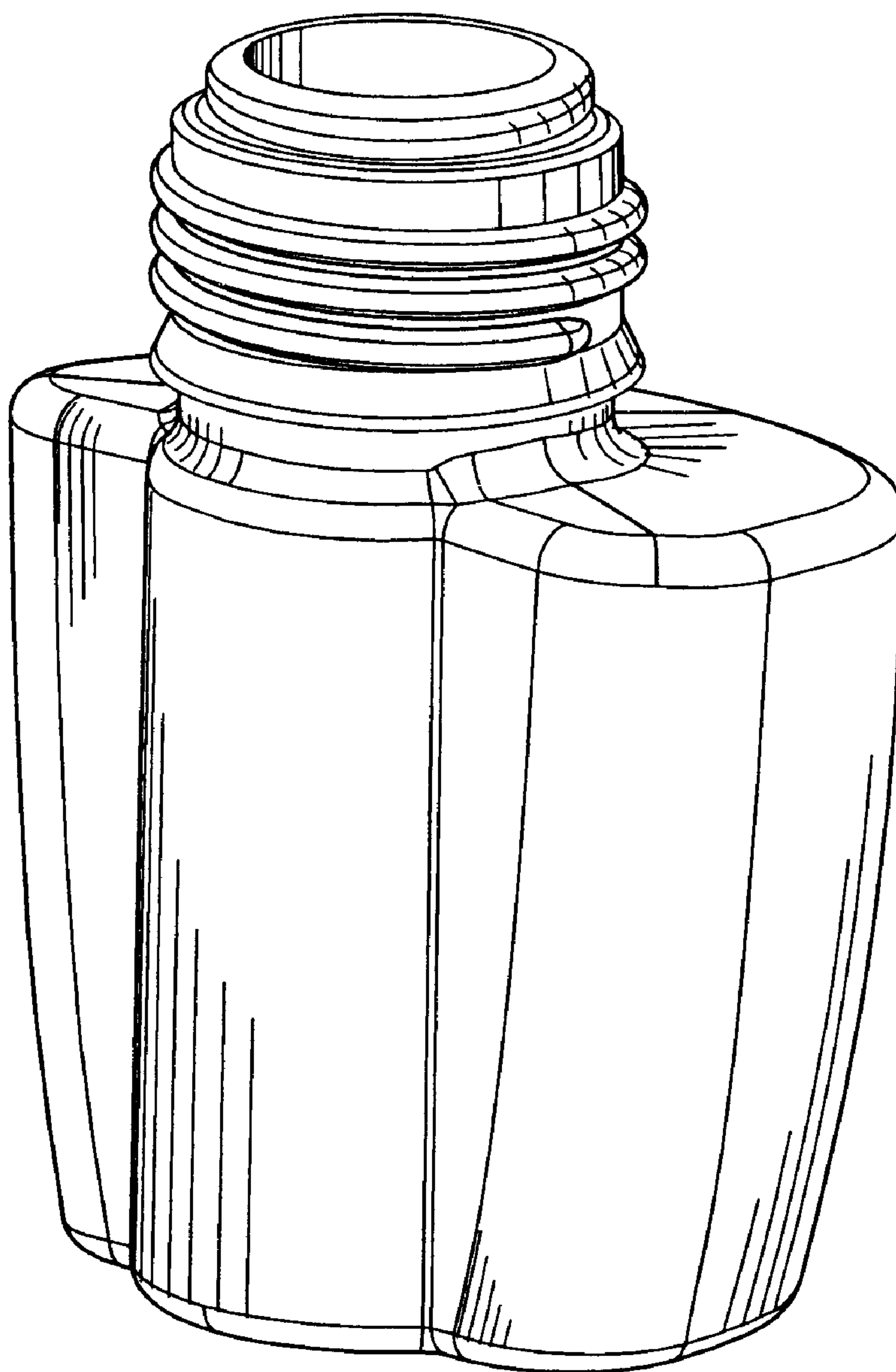
FIG. 1 is a top, rear, and left side perspective view of a  
container showing the new design;  
FIG. 2 is a top, front, and left side perspective view thereof;  
FIG. 3 is a rear elevational view thereof;  
FIG. 4 is a top plan thereof;  
FIG. 5 is a left side elevational view thereof;  
FIG. 6 is a front elevational view thereof; and,  
FIG. 7 is a right side elevational view thereof.

**1 Claim, 7 Drawing Sheets**

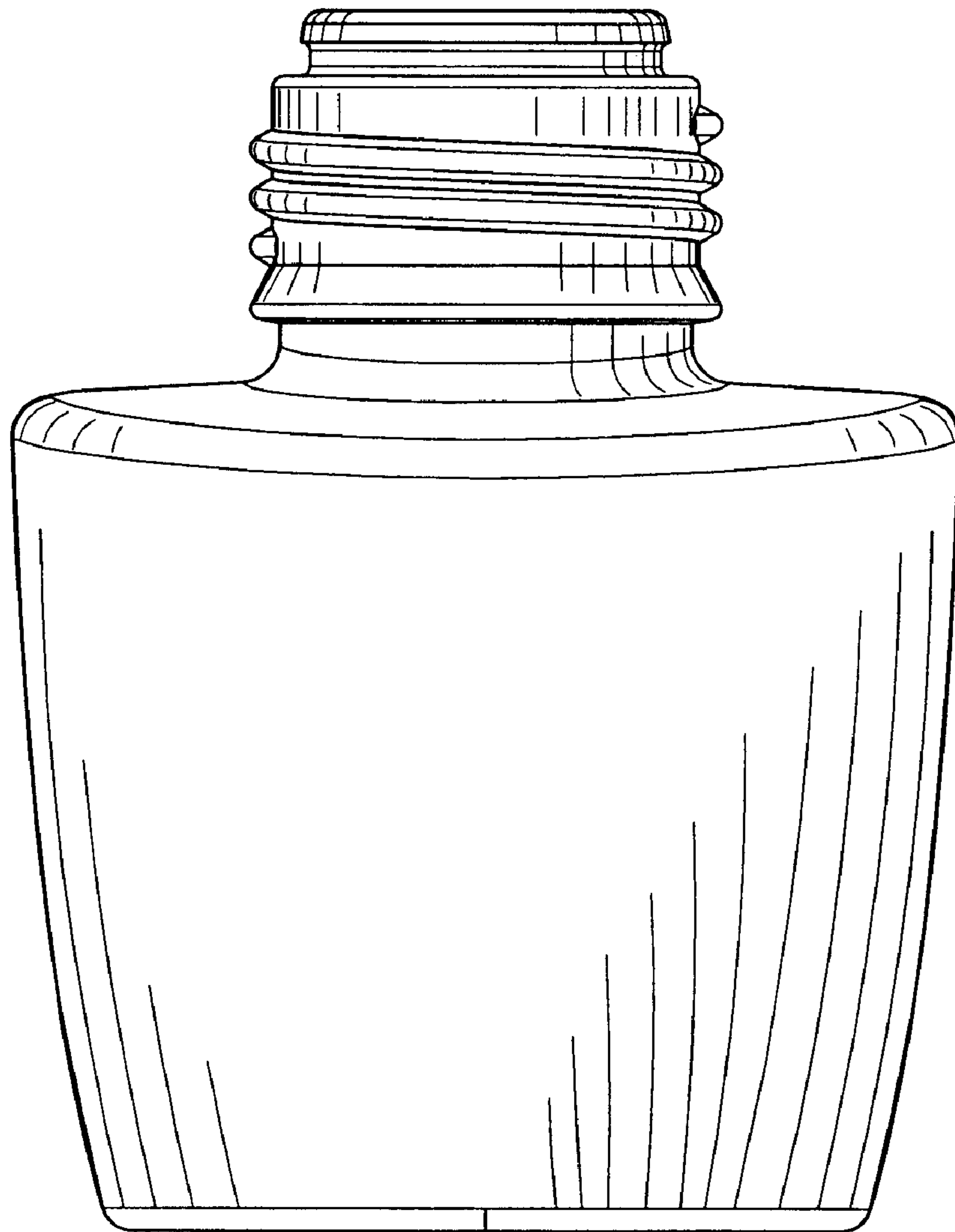




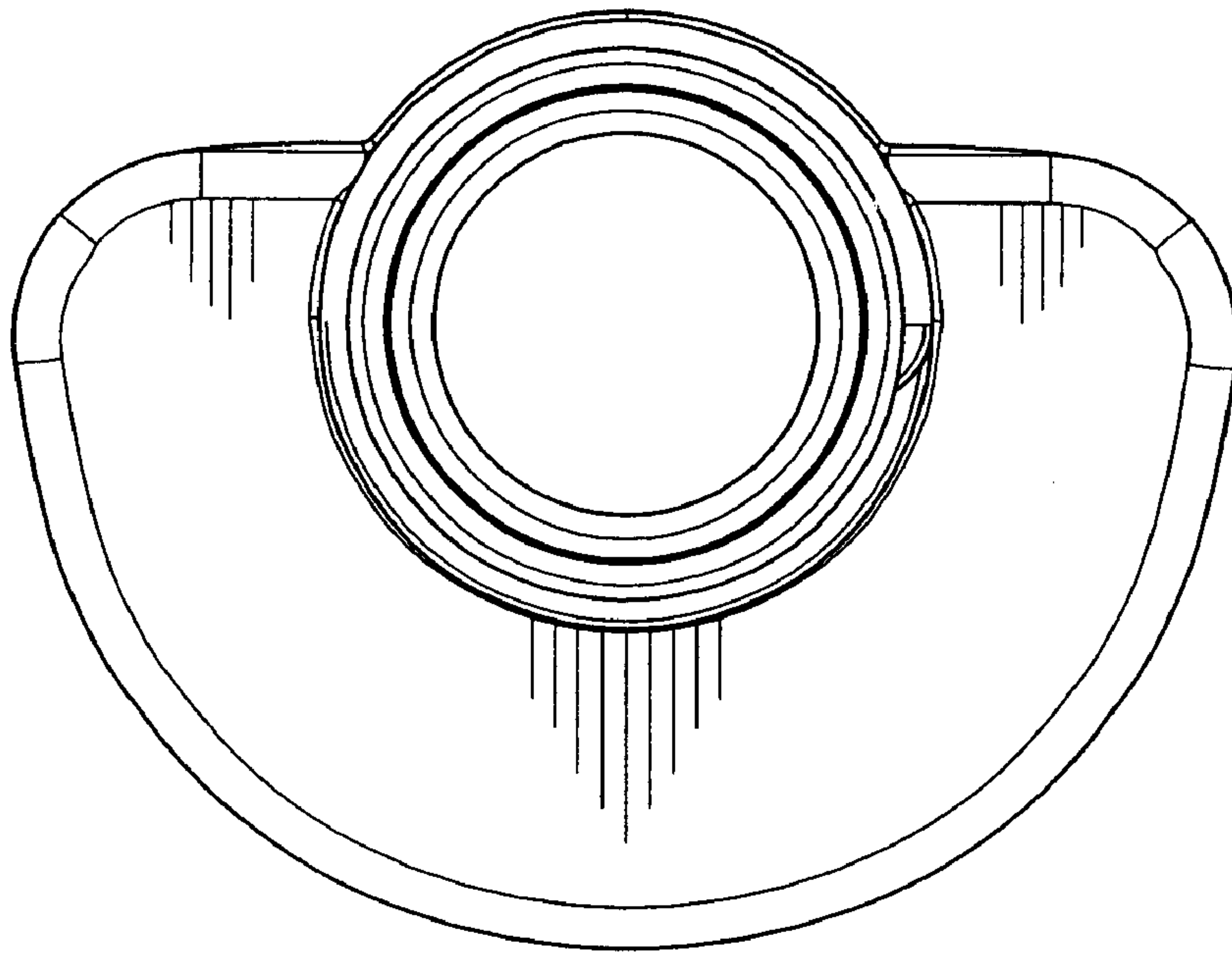
**FIG. 1**



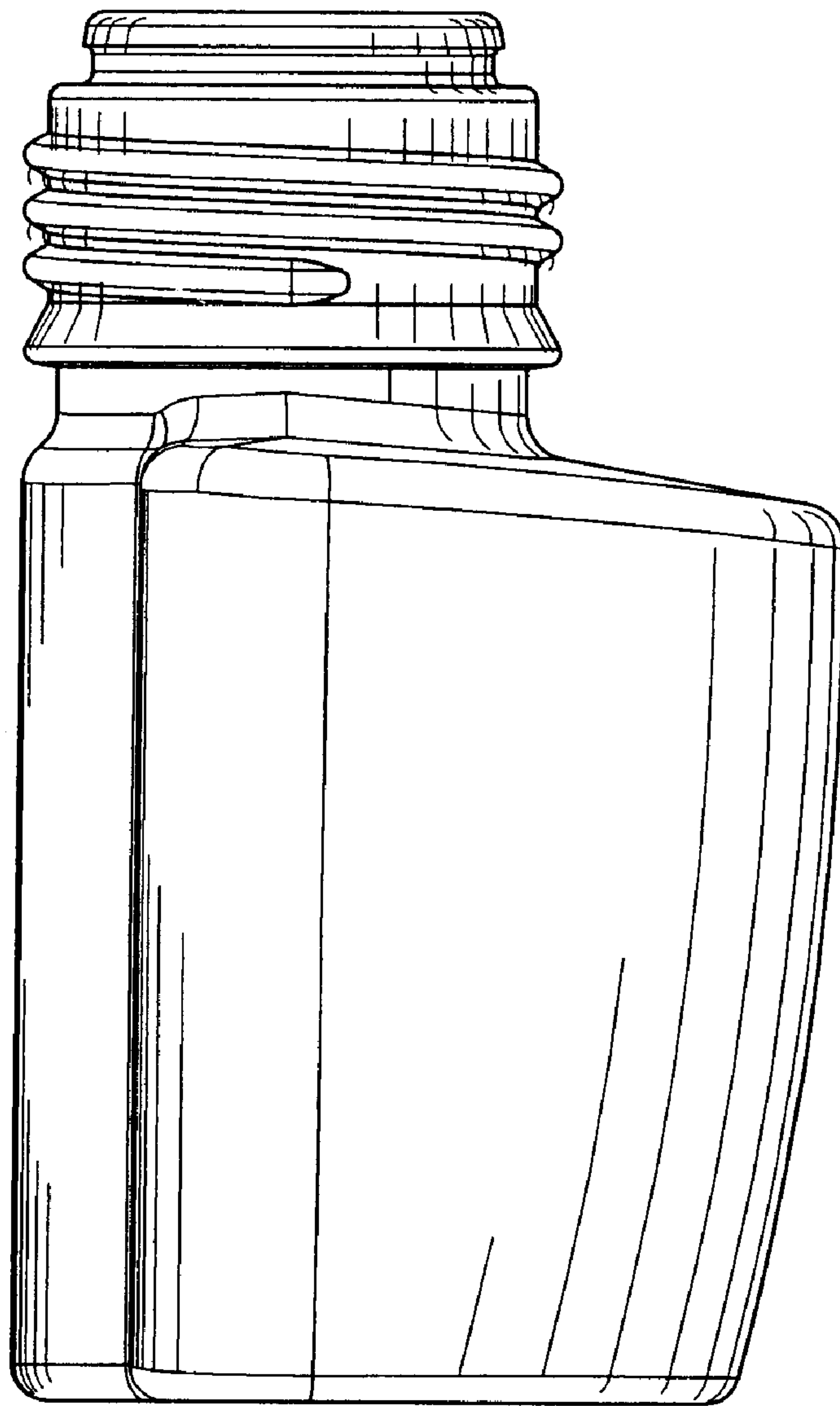
**FIG. 2**



**FIG. 3**

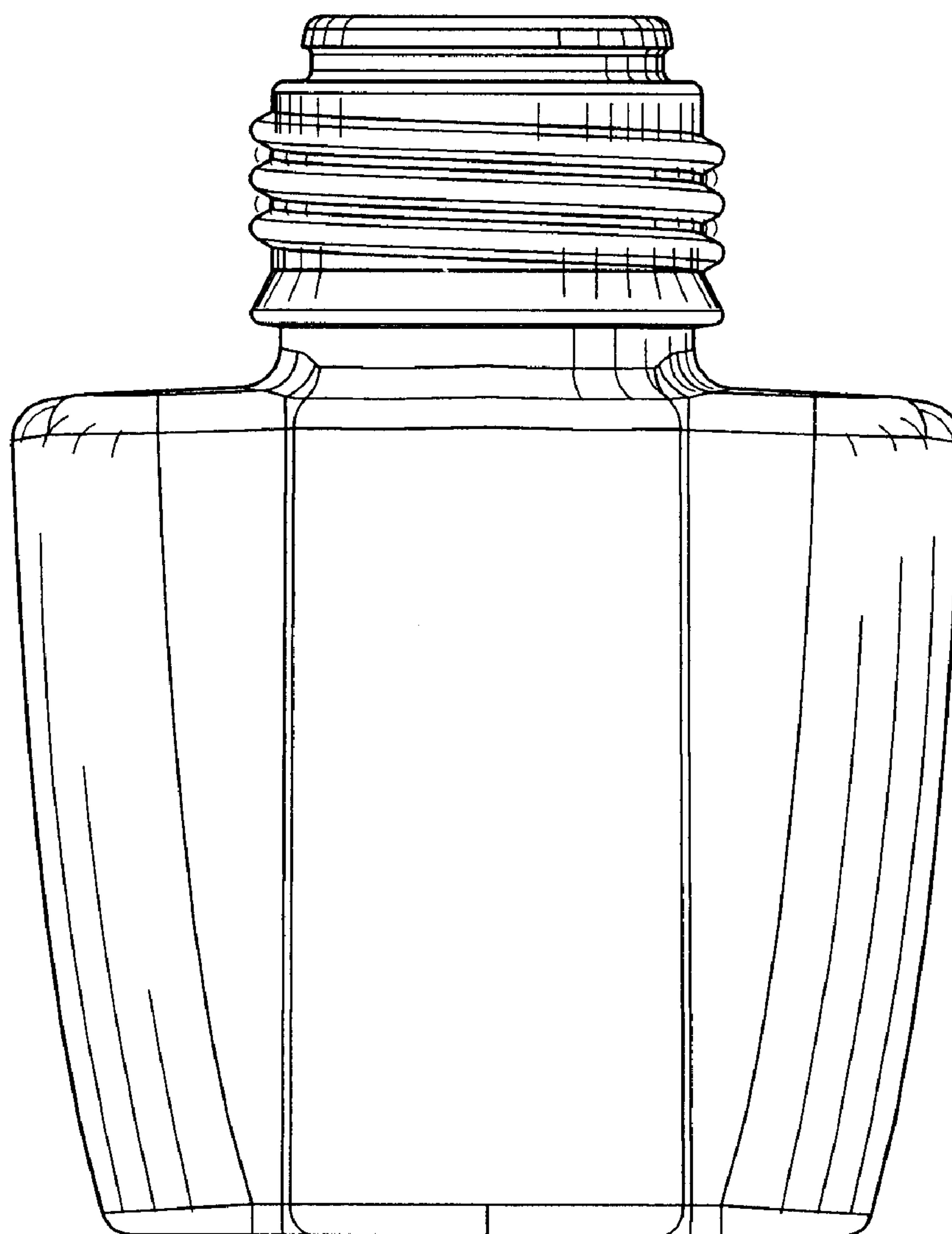


**FIG. 4**

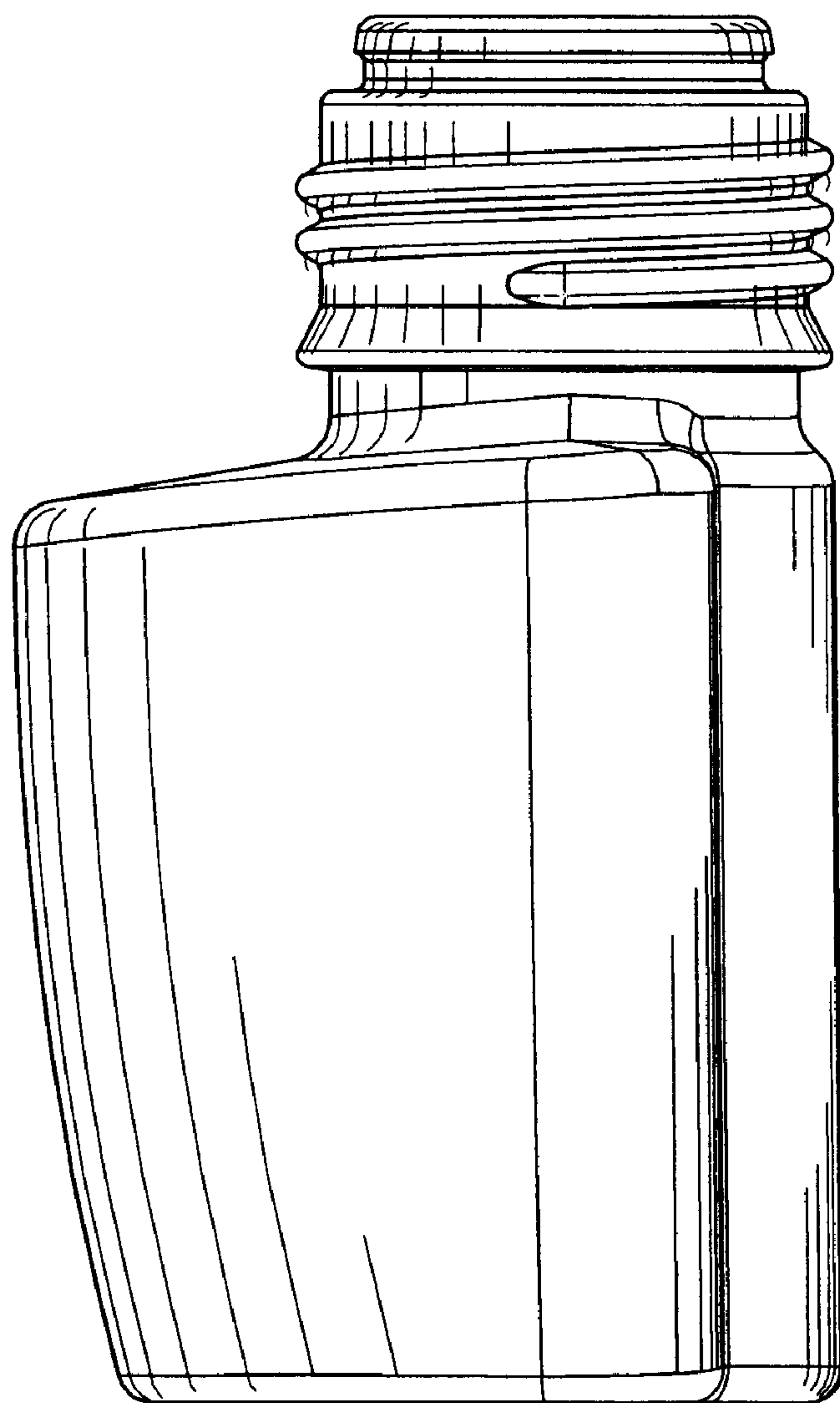


**FIG. 5**





**FIG. 6**



**FIG. 7**