



US00D536835S

(12) **United States Design Patent**  
**Kwan**

(10) **Patent No.:** **US D536,835 S**

(45) **Date of Patent:** **\*\* Feb. 13, 2007**

(54) **POT HANDLE GRIP COVER**

(75) Inventor: **Steven Kwan**, Hong Kong (HK)

(73) Assignee: **Merry Chance Industries, Ltd.**, Hong Kong (HK)

(\*\*) Term: **14 Years**

(21) Appl. No.: **29/193,517**

(22) Filed: **Nov. 10, 2003**

(51) **LOC (8) Cl.** ..... **06-13**

(52) **U.S. Cl.** ..... **D29/119**

(58) **Field of Classification Search** ..... D8/21,  
D8/107, 67, 97, 96, 94, 95, 91, 90, 83, 82,  
D8/51, DIG. 10, 80; D19/32; D4/138; D24/133;  
220/753

See application file for complete search history.

(56) **References Cited**

**U.S. PATENT DOCUMENTS**

1,990,553 A \* 2/1935 Hirsch et al. .... 2/20  
4,197,611 A \* 4/1980 Bell et al. .... 220/753

5,369,257 A \* 11/1994 Gibbon ..... 219/759  
6,305,023 B1 \* 10/2001 Barkes ..... 2/20  
D506,292 S \* 6/2005 Root et al. .... D29/119

\* cited by examiner

*Primary Examiner*—Alan P. Douglas

*Assistant Examiner*—Barbara Fox

(74) *Attorney, Agent, or Firm*—Barnes & Thornburg LLP;  
Timothy J. Engling

(57) **CLAIM**

The ornamental design for a pot handle grip cover, as shown and described.

**DESCRIPTION**

FIG. 1 is an upper perspective view;  
FIG. 2 is a lower perspective view;  
FIG. 3 is a top view;  
FIG. 4 is a side view;  
FIG. 5 is a front view;  
FIG. 6 is a side view;  
FIG. 7 is a bottom view; and,  
FIG. 8 is a back view.

**1 Claim, 2 Drawing Sheets**

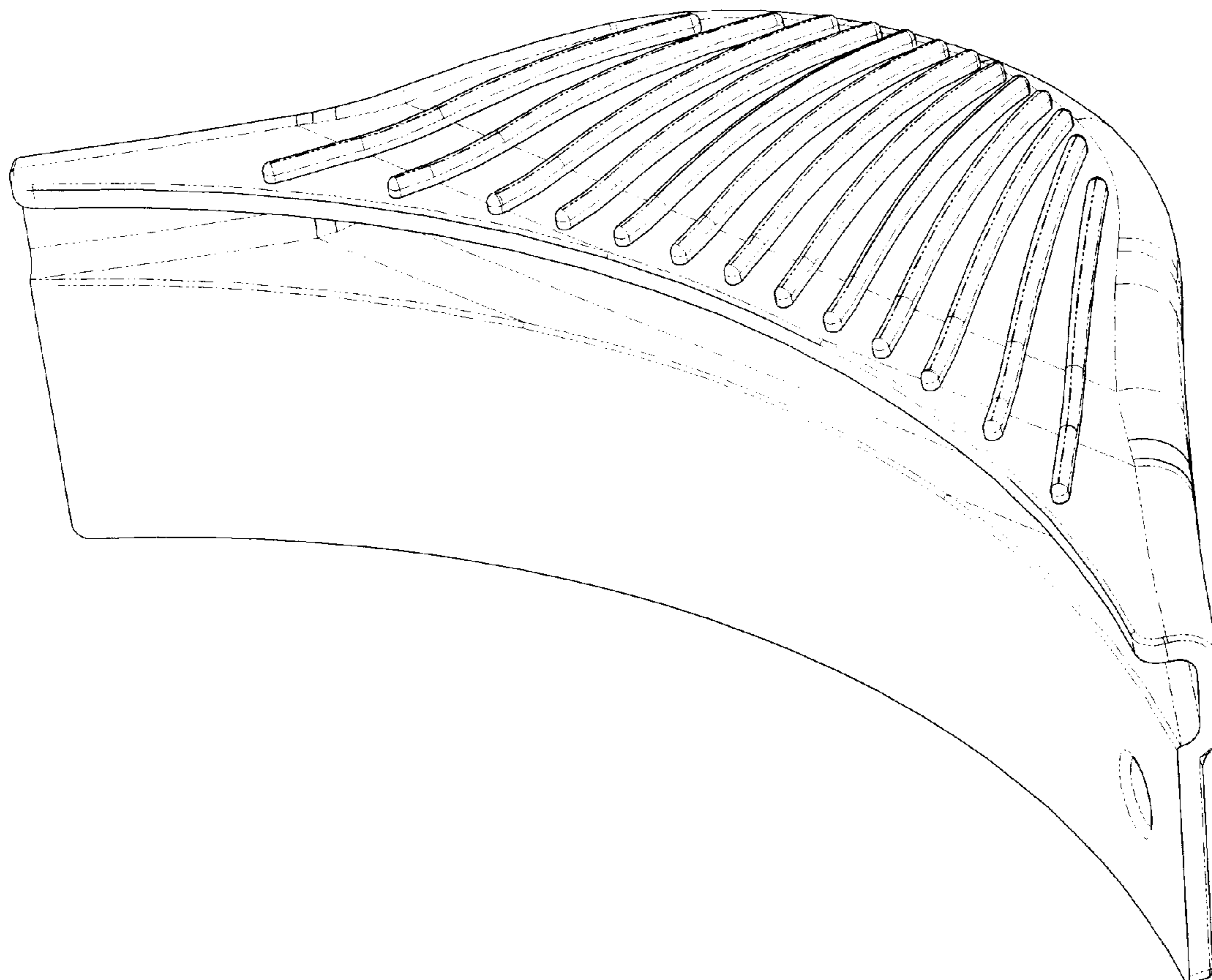

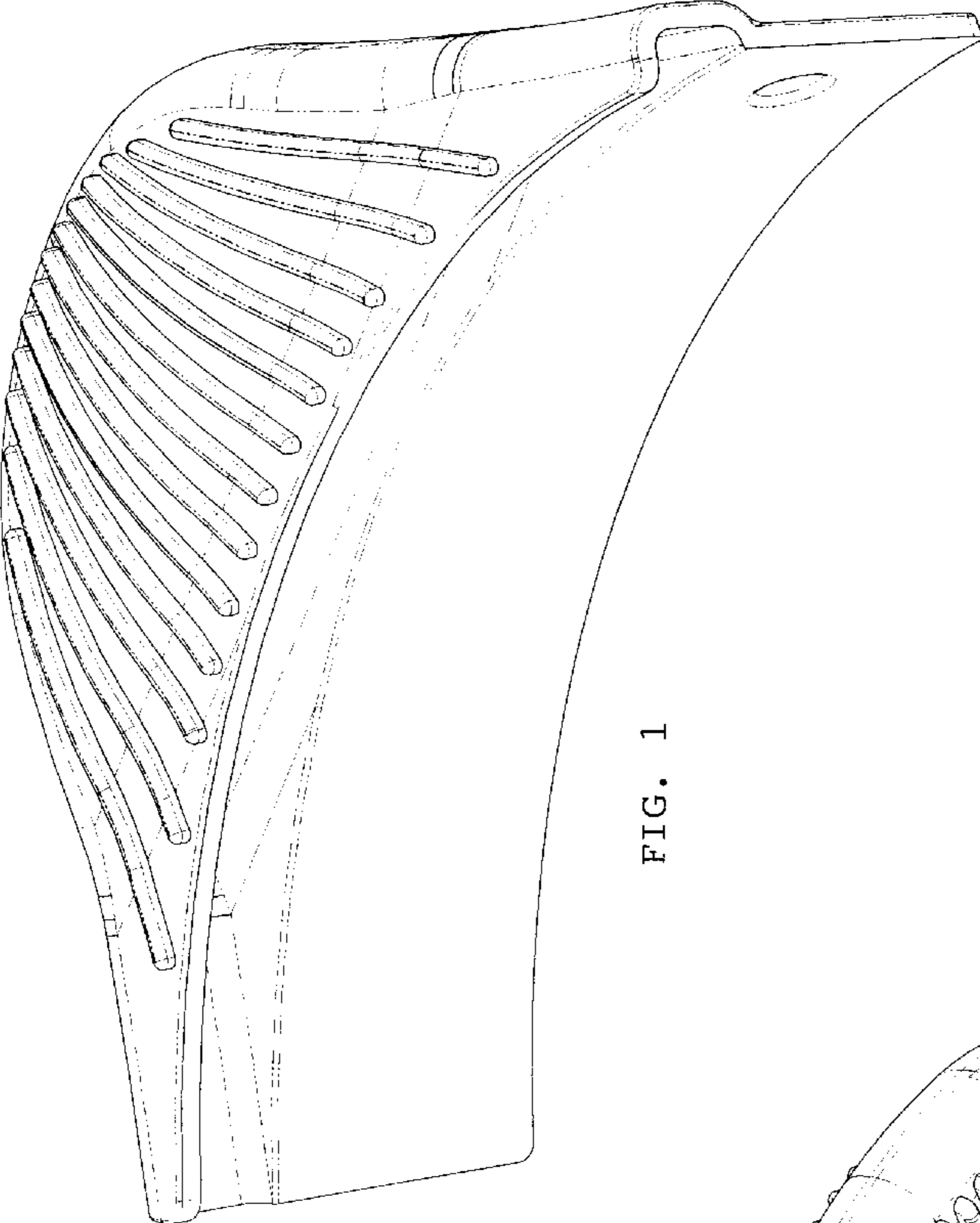

FIG. 1

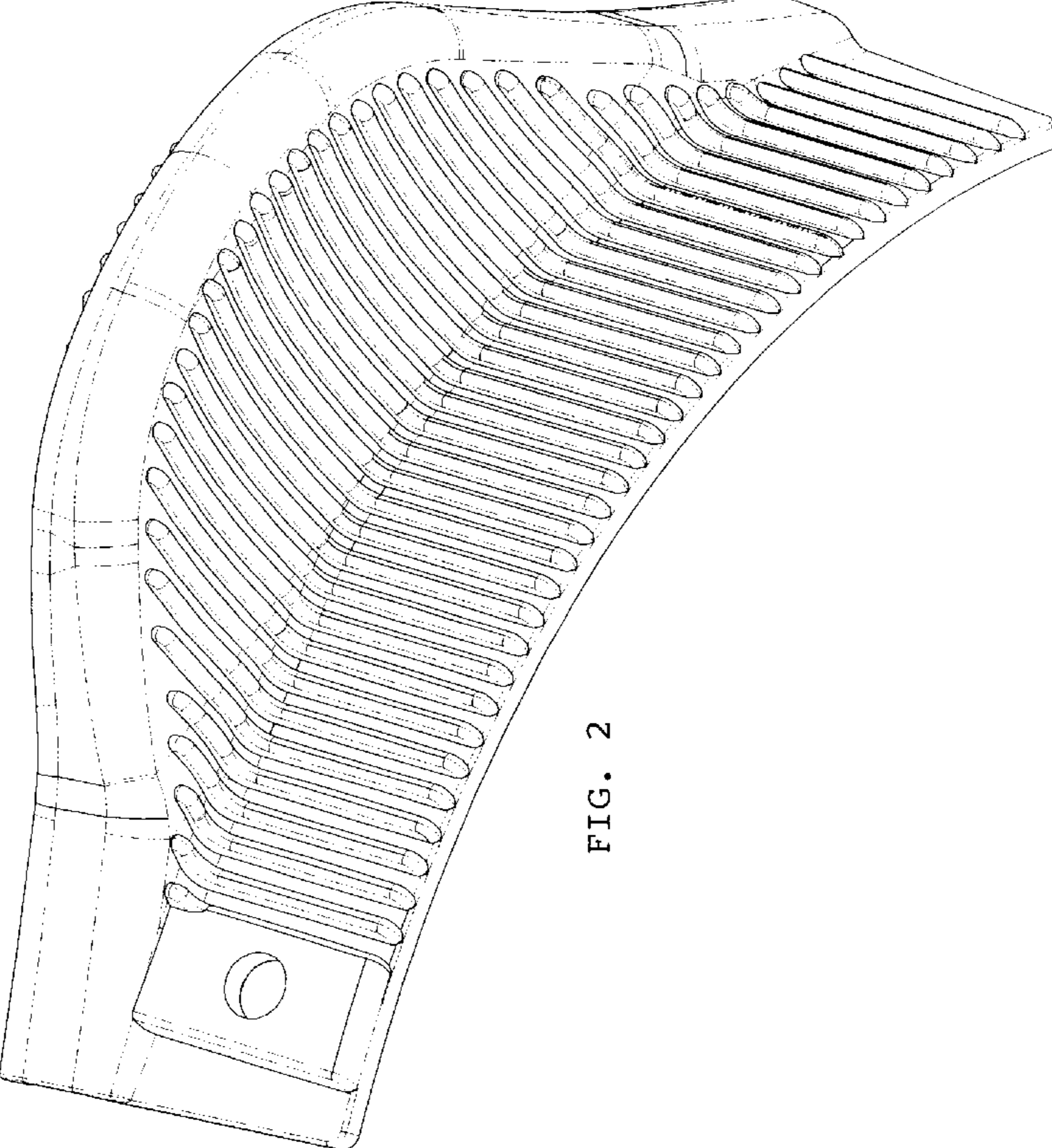

FIG. 2

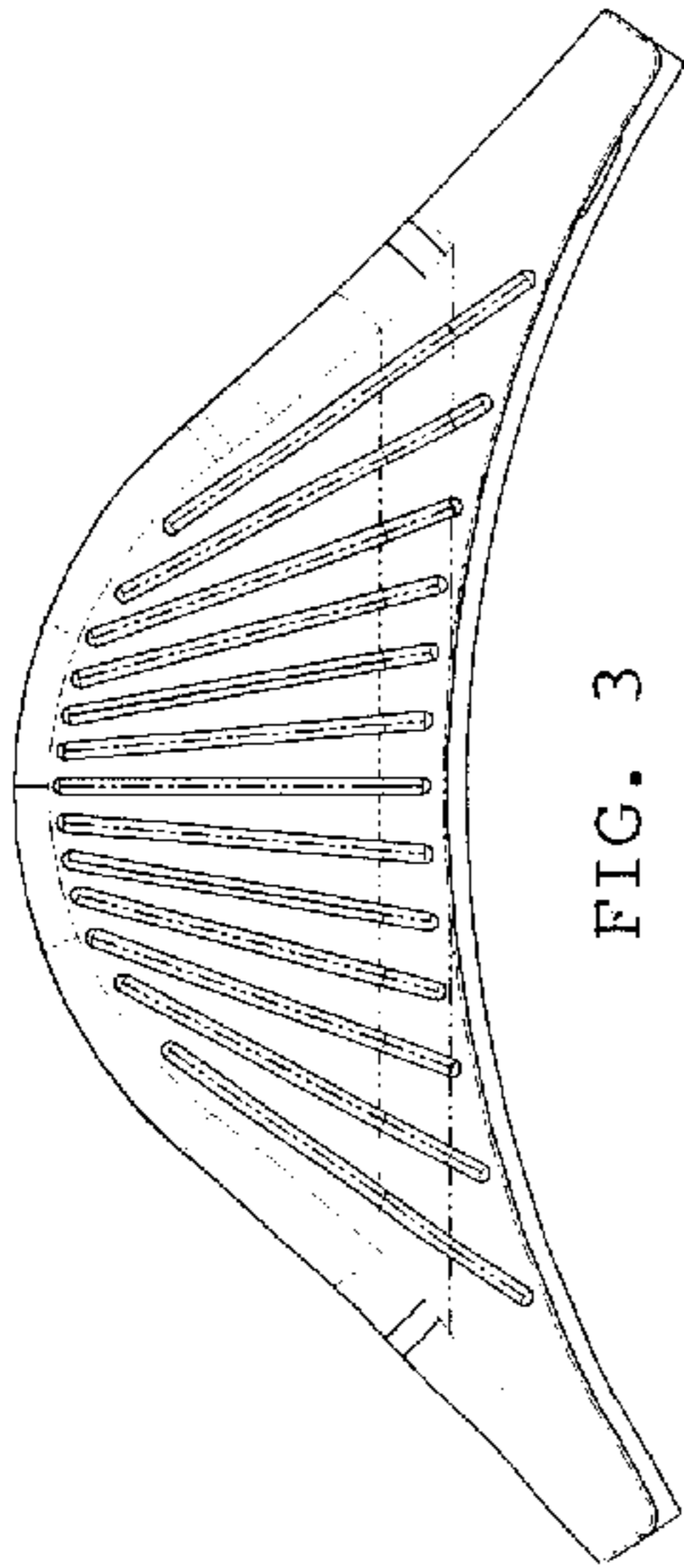

FIG. 3

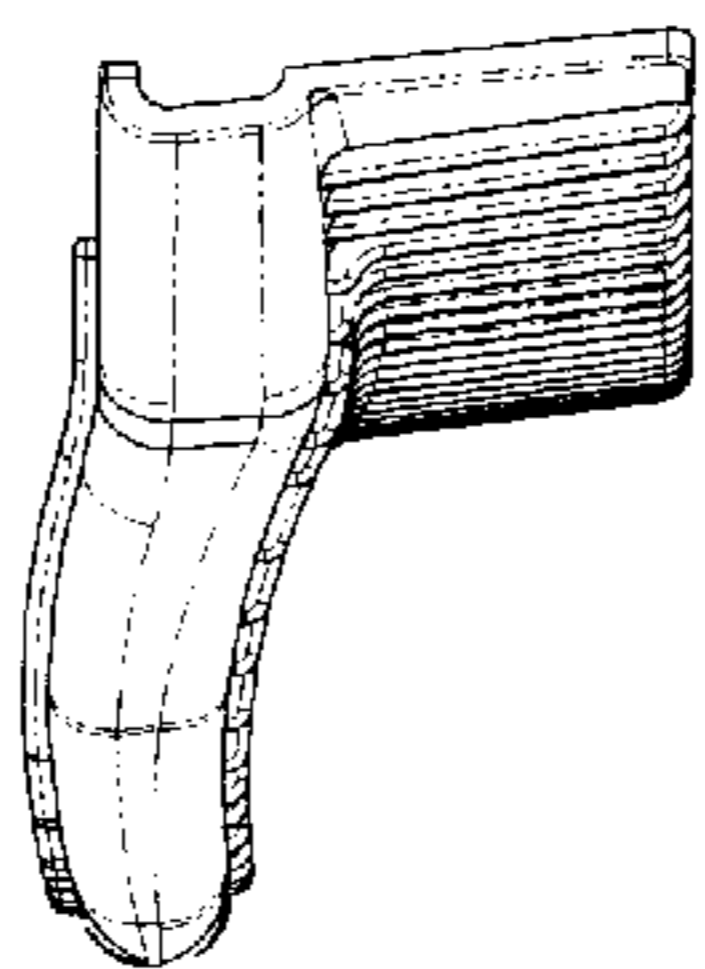

FIG. 4

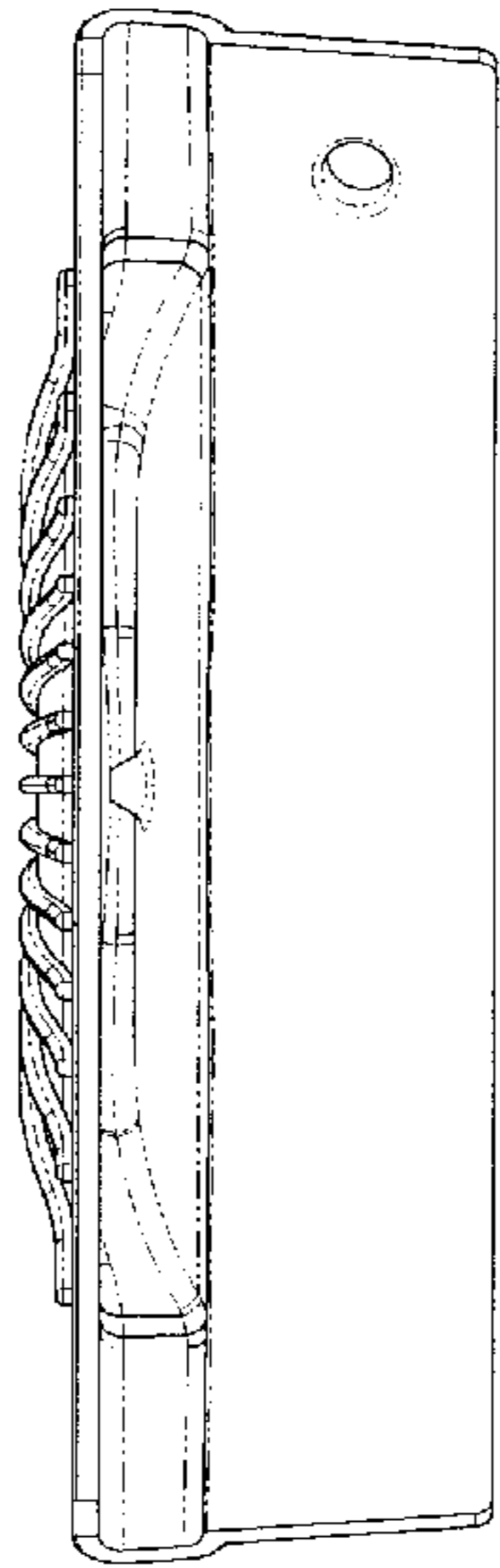

FIG. 5

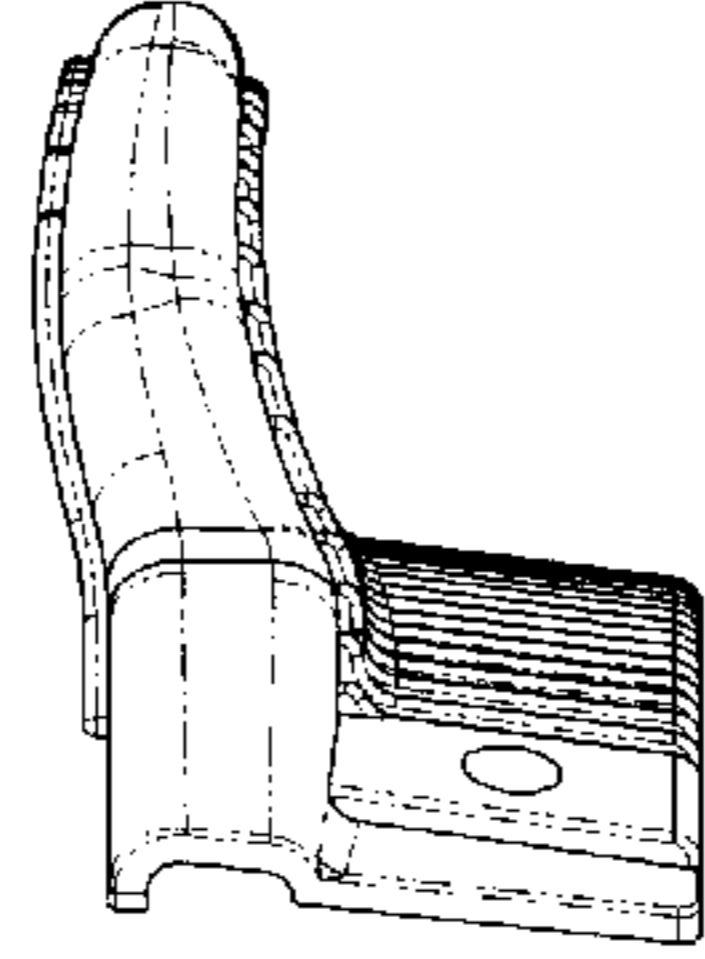

FIG. 6

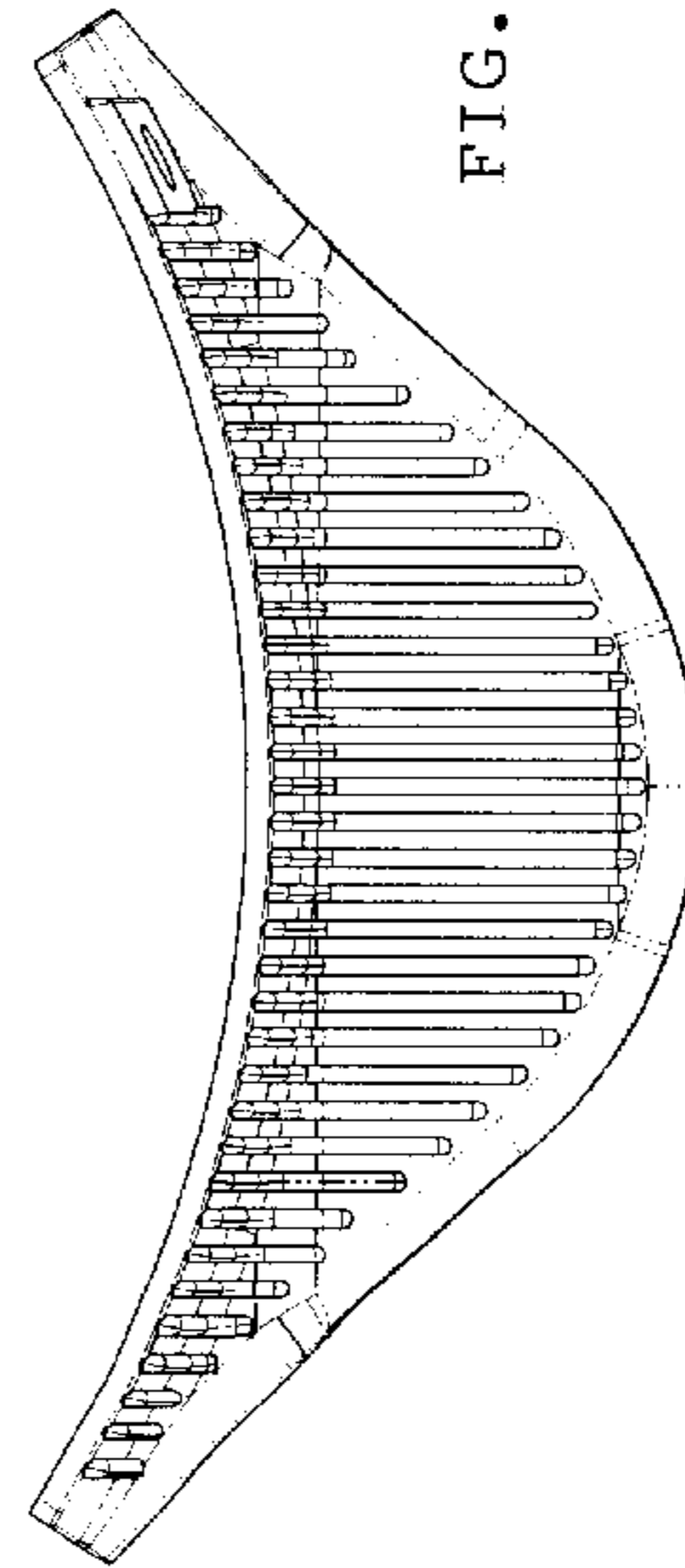

FIG. 7

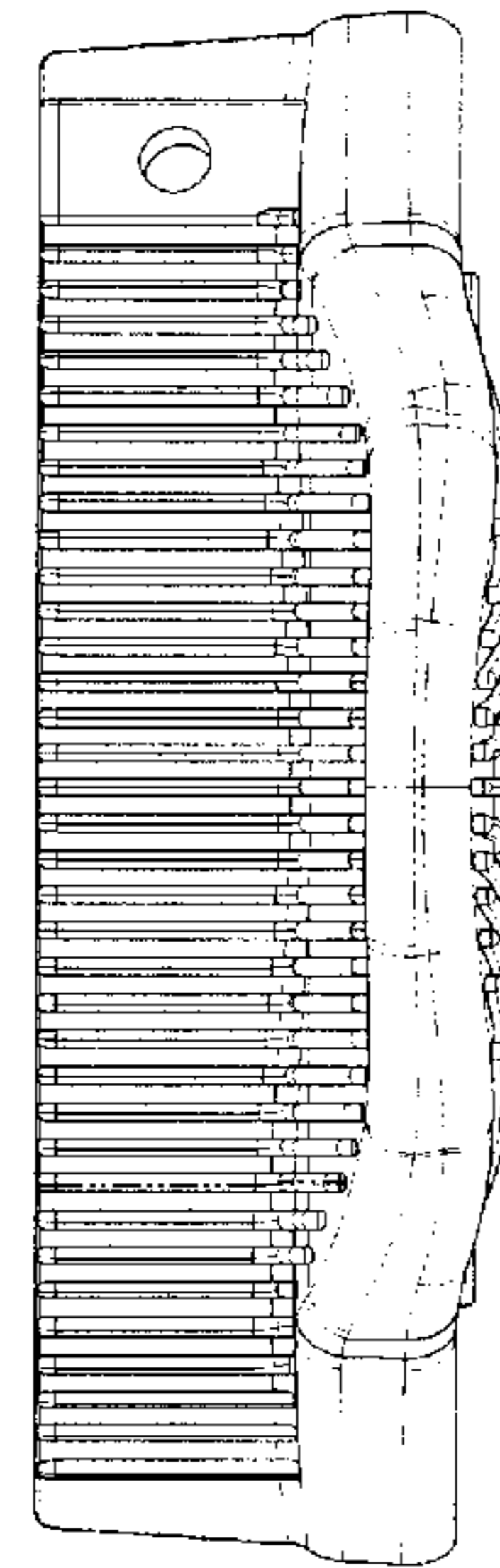

FIG. 8