



US00D536687S

(12) **United States Design Patent** (10) **Patent No.:** **US D536,687 S**
Lheem (45) **Date of Patent:** **** Feb. 13, 2007**

(54) **MOBILE PHONE**

(75) Inventor: **Ji Youn Lheem**, Seoul (KR)

(73) Assignee: **LG Electronics Inc.**, Seoul (KR)

(**) Term: **14 Years**

(21) Appl. No.: **29/229,850**

(22) Filed: **May 13, 2005**

(30) **Foreign Application Priority Data**

Nov. 15, 2004 (KR) 30-2004-0034755

(51) **LOC (8) Cl.** **14-03**

(52) **U.S. Cl.** **D14/138**

(58) **Field of Classification Search** D14/191,
D14/138, 147-148, 247-248, 144, 496, 156,
D14/341-347; 379/433.01-433.13; 455/575.3,
455/566, 575.1, 556.1, 556.2, 90.3; D21/517;
D16/208

See application file for complete search history.

(56) **References Cited**

U.S. PATENT DOCUMENTS

D488,453 S	*	4/2004	Chang et al.	D14/138
D495,674 S	*	9/2004	Yoo et al.	D14/138
D496,021 S	*	9/2004	Jang	D14/138
D496,643 S	*	9/2004	Yoo et al.	D14/138
D500,480 S	*	1/2005	Daw	D14/138
D502,161 S	*	2/2005	Kim et al.	D14/138
D507,787 S	*	7/2005	Ahn et al.	D14/138
D508,034 S	*	8/2005	Liao	D14/138
D508,036 S	*	8/2005	Wada	D14/138
D518,463 S	*	4/2006	Tan et al.	D14/138
D519,486 S	*	4/2006	Lee et al.	D14/138
D519,972 S	*	5/2006	Chung et al.	D14/138
D519,973 S	*	5/2006	Chung et al.	D14/138
D520,483 S	*	5/2006	Park et al.	D14/138
D520,980 S	*	5/2006	Taniyama et al.	D14/138

D520,981 S	*	5/2006	Lee et al.	D14/138
D521,481 S	*	5/2006	Shin	D14/138
D521,968 S	*	5/2006	Jung et al.	D14/138
D521,970 S	*	5/2006	Han et al.	D14/138
2004/0209645 A1	*	10/2004	Park et al.	455/556.1

OTHER PUBLICATIONS

Samsung D810 telephone, announced 1st Quarter 2006, [online], [retrieved on Sep. 14, 2006]. Retrieved from Internet ,<URL: http://www.gsmarena.com>.*

BenQ-Siemens EF61 telephone, announced Jul. 2006, [online], [retrieved on Aug. 29, 2006]. Retrieved from Internet ,<URL: http://www.gsmarena.com>.*

Samsung Z300 telephone, announced 1st Quarter 2005, [online], [retrieved on Aug. 29, 2006]. Retrieved from Internet ,<URL: http://www.gsmarena.com>.*

Motorola V3x telephone, announced 1st Quarter 2005, [online], [retrieved on Sep. 14, 2006]. Retrieved from Internet ,<URL: http://www.gsmarena.com>.*

* cited by examiner

Primary Examiner—Jeffrey Asch

(74) *Attorney, Agent, or Firm*—Birch, Stewart, Kolasch & Birch, LLP

(57) **CLAIM**

The ornamental design for a mobile phone, as shown and described.

DESCRIPTION

FIG. 1 is a perspective view of a mobile phone showing my (our) new design;

FIG. 2 is a front view thereof;

FIG. 3 is a rear view thereof;

FIG. 4 is a left side view thereof;

FIG. 5 is a right side view thereof;

FIG. 6 is a top plan view thereof; and,

FIG. 7 is a bottom plan view thereof.

1 Claim, 6 Drawing Sheets

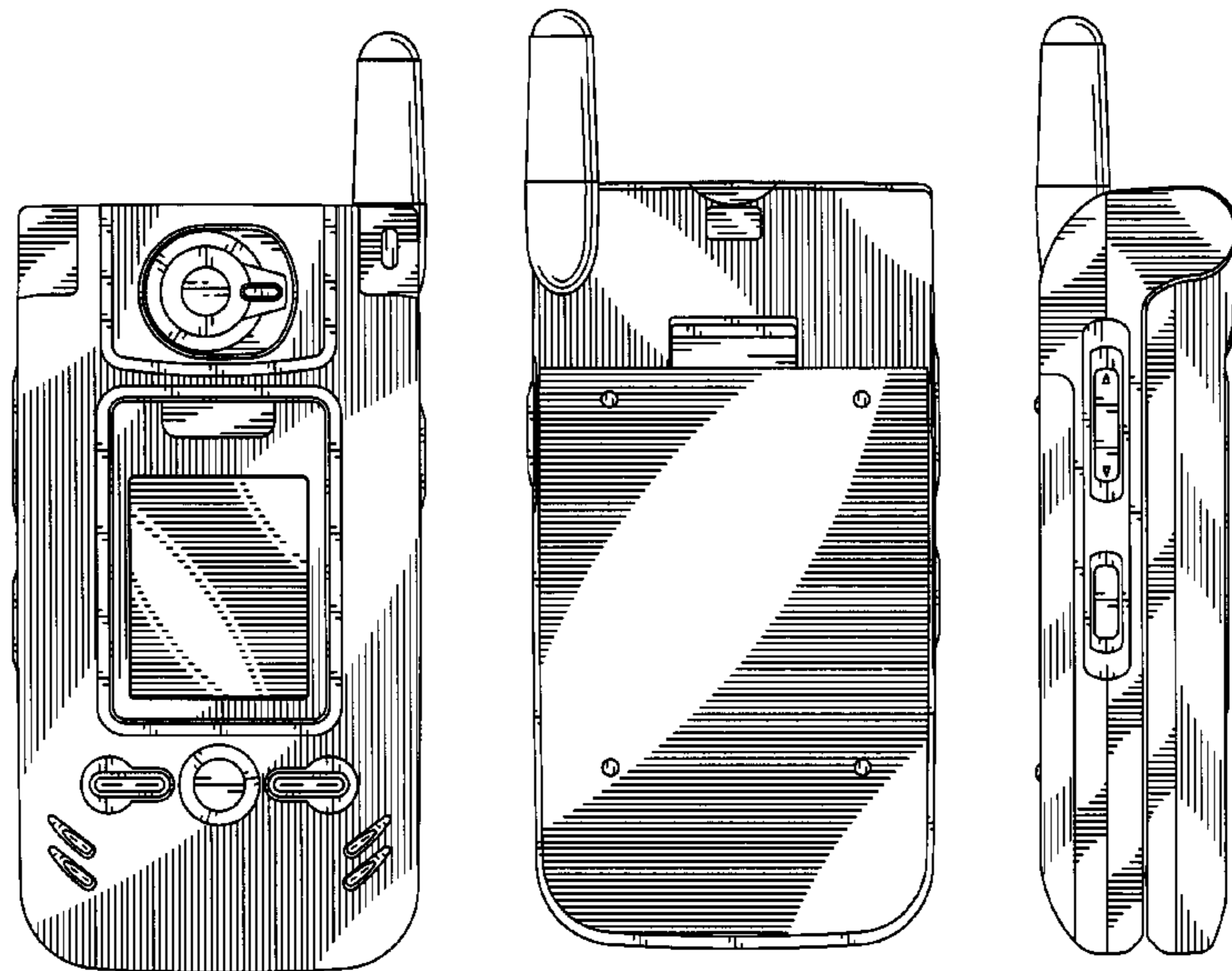

FIG. 1

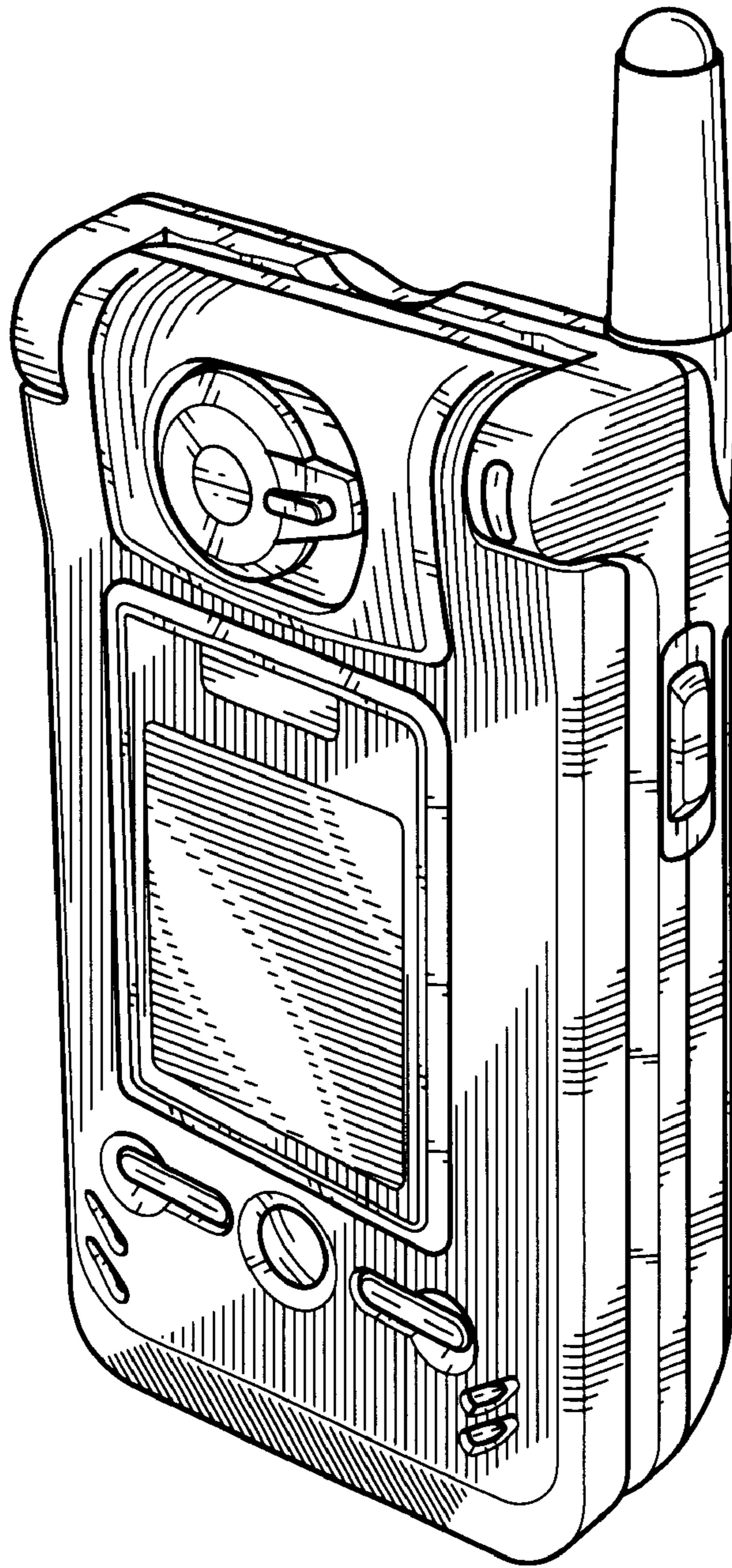

FIG. 2

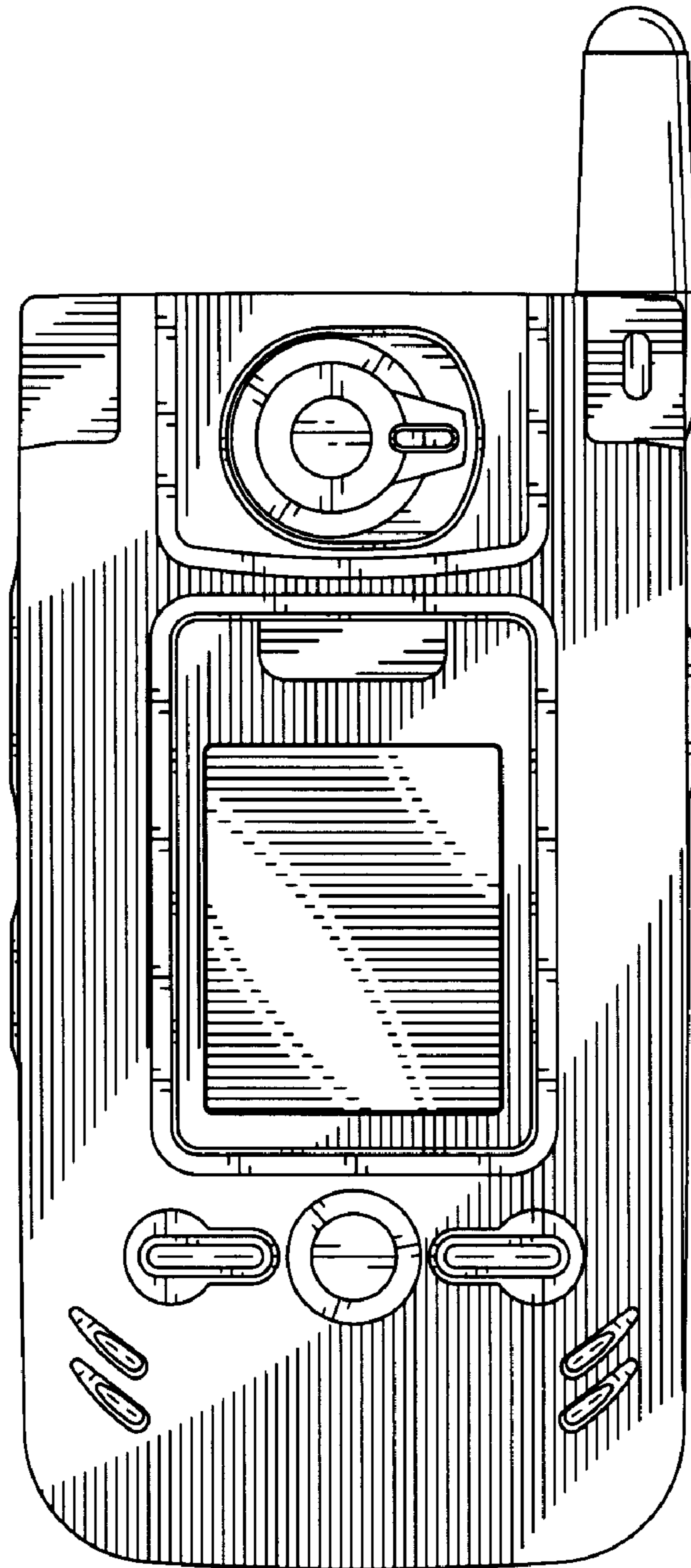

FIG. 3

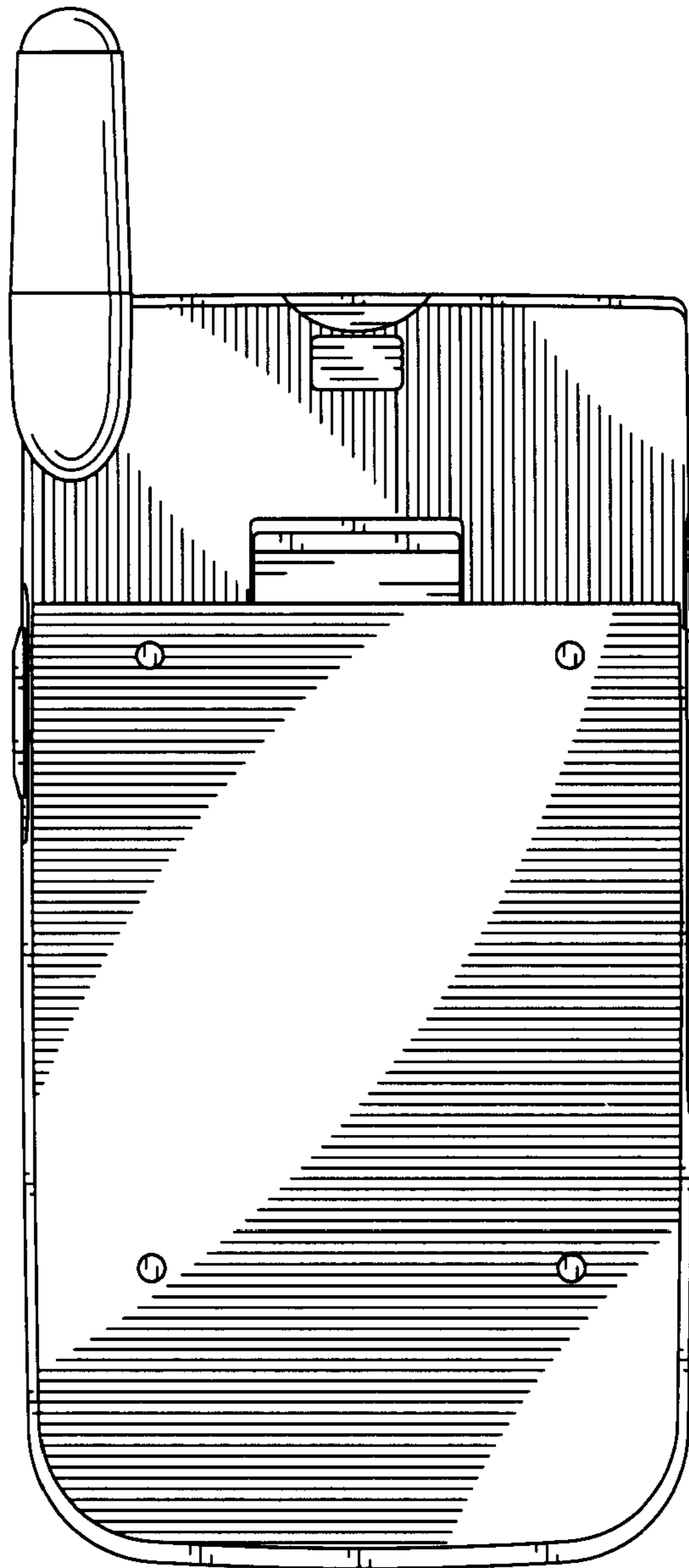

FIG. 4

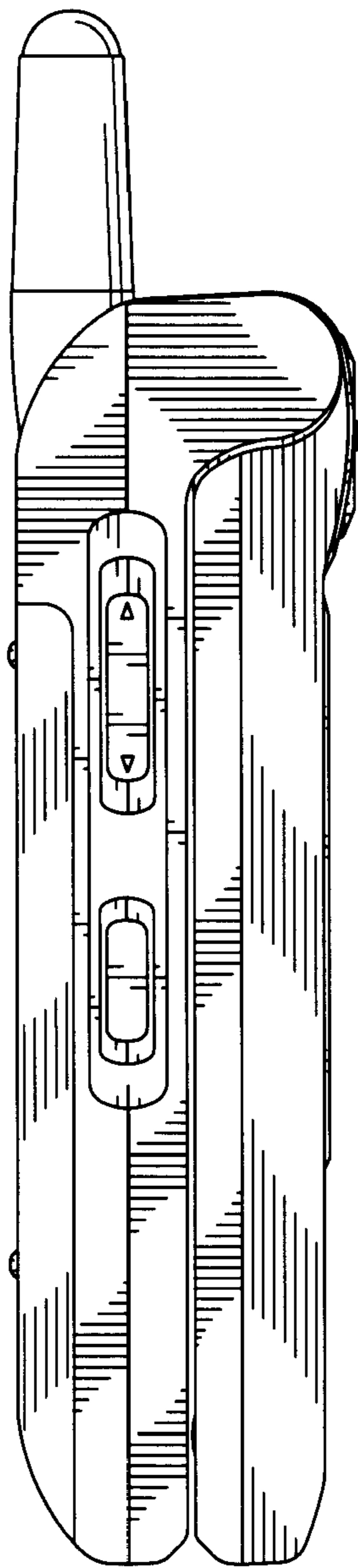

FIG. 5

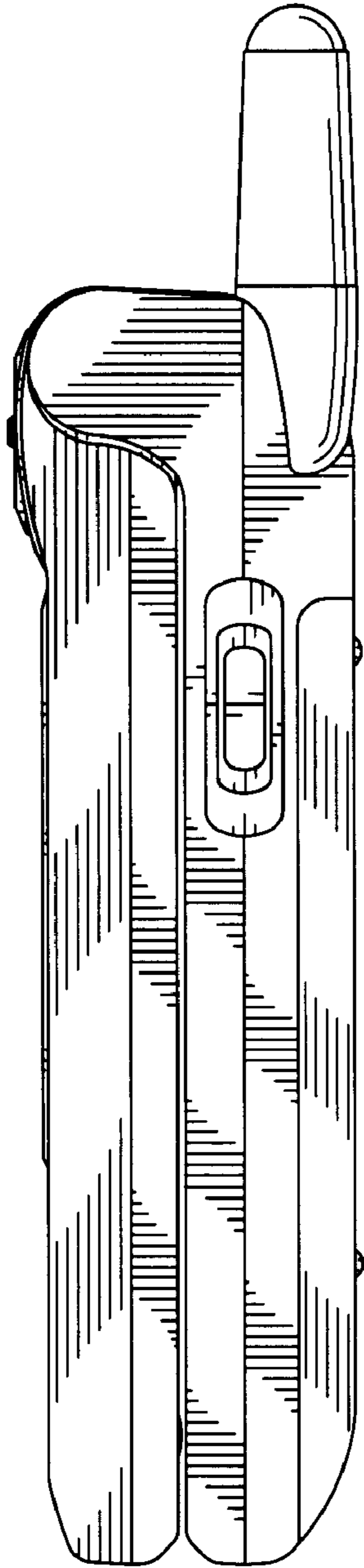

FIG. 6

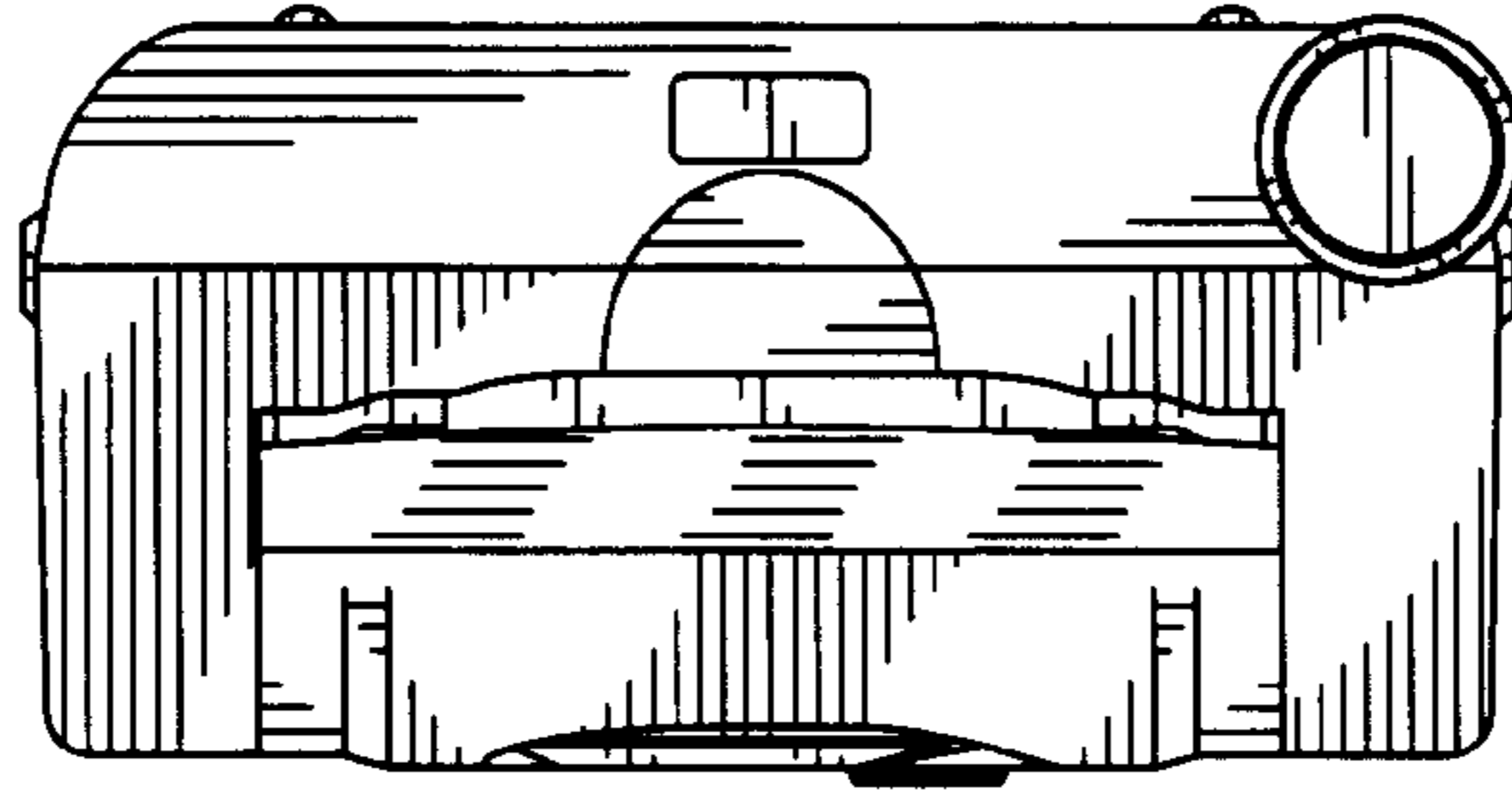

FIG. 7

