



US00D536676S

(12) **United States Design Patent**  
**Ng et al.**

(10) **Patent No.:** **US D536,676 S**  
(45) **Date of Patent:** **\*\* Feb. 13, 2007**

(54) **TELEVISION SET**

(75) Inventors: **Po Yi Ng**, Sunnyvale, CA (US); **Chris Heatherly**, Monrovia, CA (US)

(73) Assignee: **Disney Enterprises, Inc.**, Burbank, CA (US)

(\*\*) Term: **14 Years**

(21) Appl. No.: **29/204,978**

(22) Filed: **May 6, 2004**

(51) **LOC (8) Cl.** ..... **14-03**

(52) **U.S. Cl.** ..... **D14/126**

(58) **Field of Classification Search** ..... D14/125-134,  
D14/239, 371, 136, 374-377; 312/7.2; 348/836,  
348/838, 180, 184, 325, 739; 341/12; 248/917-924,  
248/465; 345/104, 133, 156, 168, 87, 173;  
720/605, 669, 600, 655; 369/99, 197; 455/344-347  
See application file for complete search history.

(56) **References Cited**

**U.S. PATENT DOCUMENTS**

D453,747 S \* 2/2002 Kita ..... D14/126  
D456,049 S \* 4/2002 Hood ..... D21/515  
D458,910 S \* 6/2002 Kita ..... D14/126

D497,885 S \* 11/2004 Esslinger et al. .... D14/126

\* cited by examiner

*Primary Examiner*—Raphael Barkai  
(74) *Attorney, Agent, or Firm*—Greenberg Traurig, LLP;  
Pablo E. Tapia, Esq.; Stephen Warhola, Esq.

(57) **CLAIM**

The ornamental design for a television set, as shown and described.

**DESCRIPTION**

FIG. 1 is a perspective view of a television set showing our new design;

FIG. 2 is a front elevational view thereof;

FIG. 3 is a rear elevational view thereof;

FIG. 4 is a top plan view thereof;

FIG. 5 is a bottom plan view thereof;

FIG. 6 is a left side elevational view thereof;

FIG. 7 is a right side elevational view thereof;

FIG. 8 is a perspective view of a modified embodiment of the design shown in FIGS. 1-7;

FIG. 9 is a front elevational view thereof;

FIG. 10 is a rear elevational view thereof;

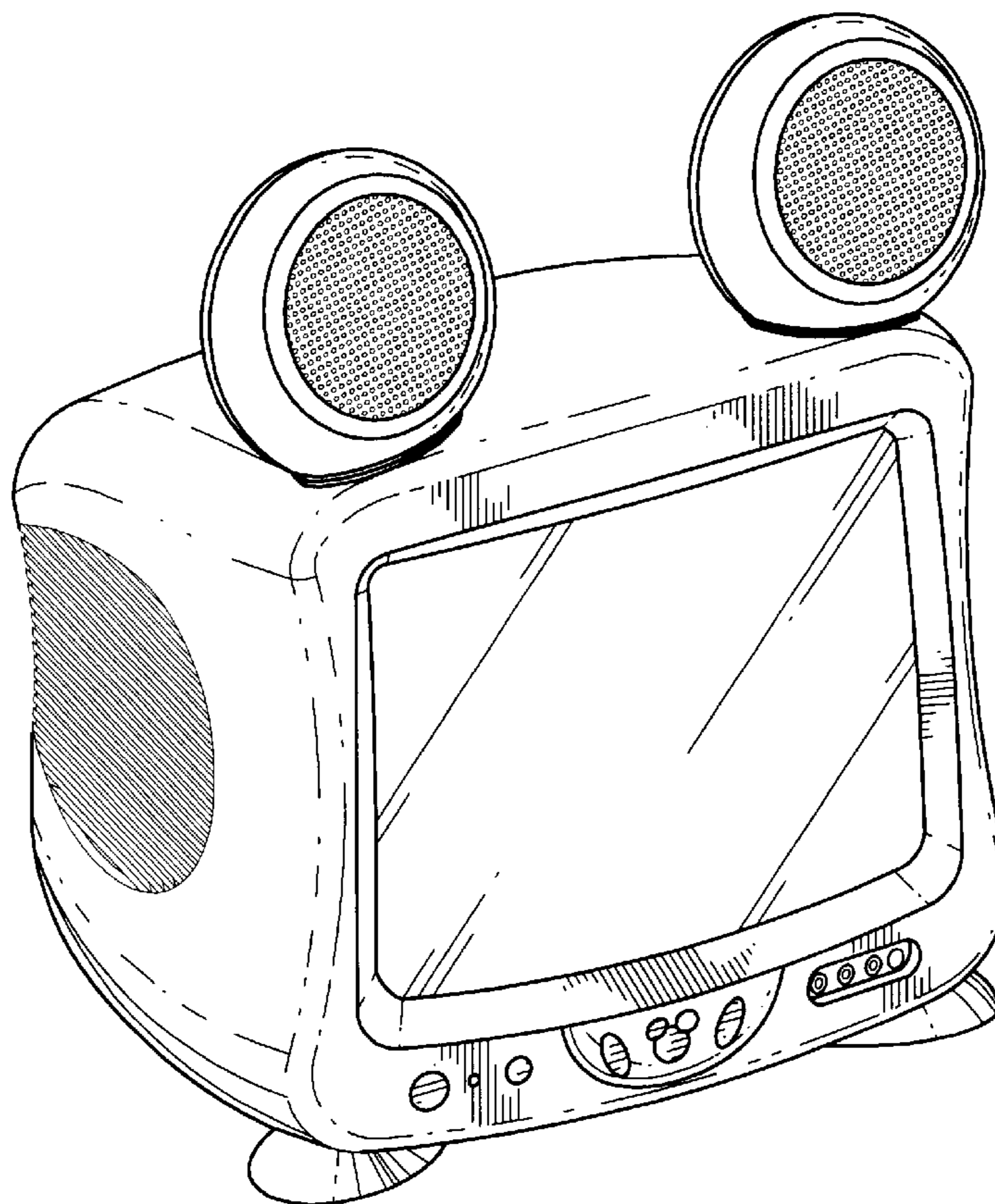
FIG. 11 is a top plan view thereof;

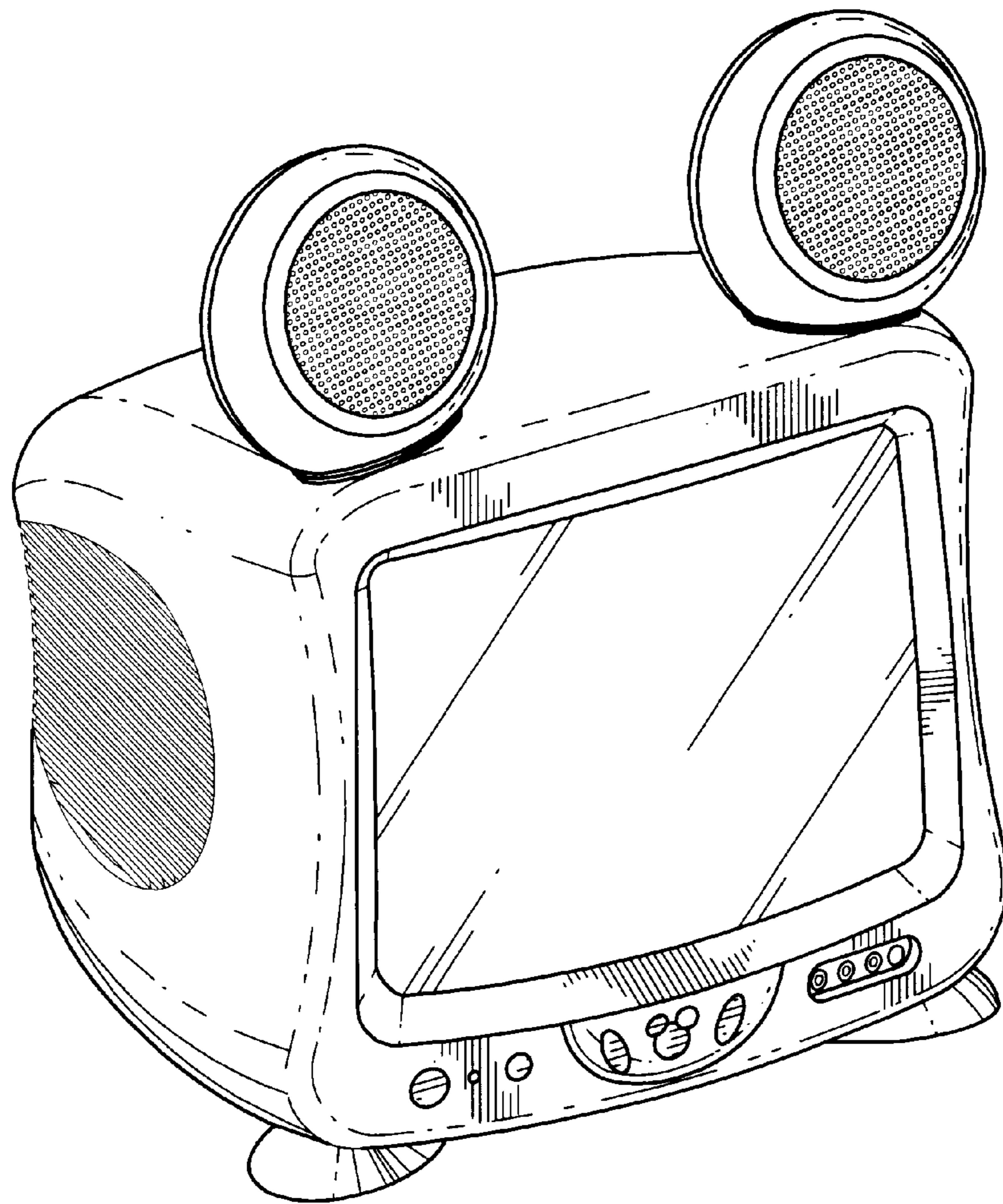
FIG. 12 is a bottom plan view thereof;

FIG. 13 is a left side elevational view thereof; and,

FIG. 14 is a right side elevational view thereof.

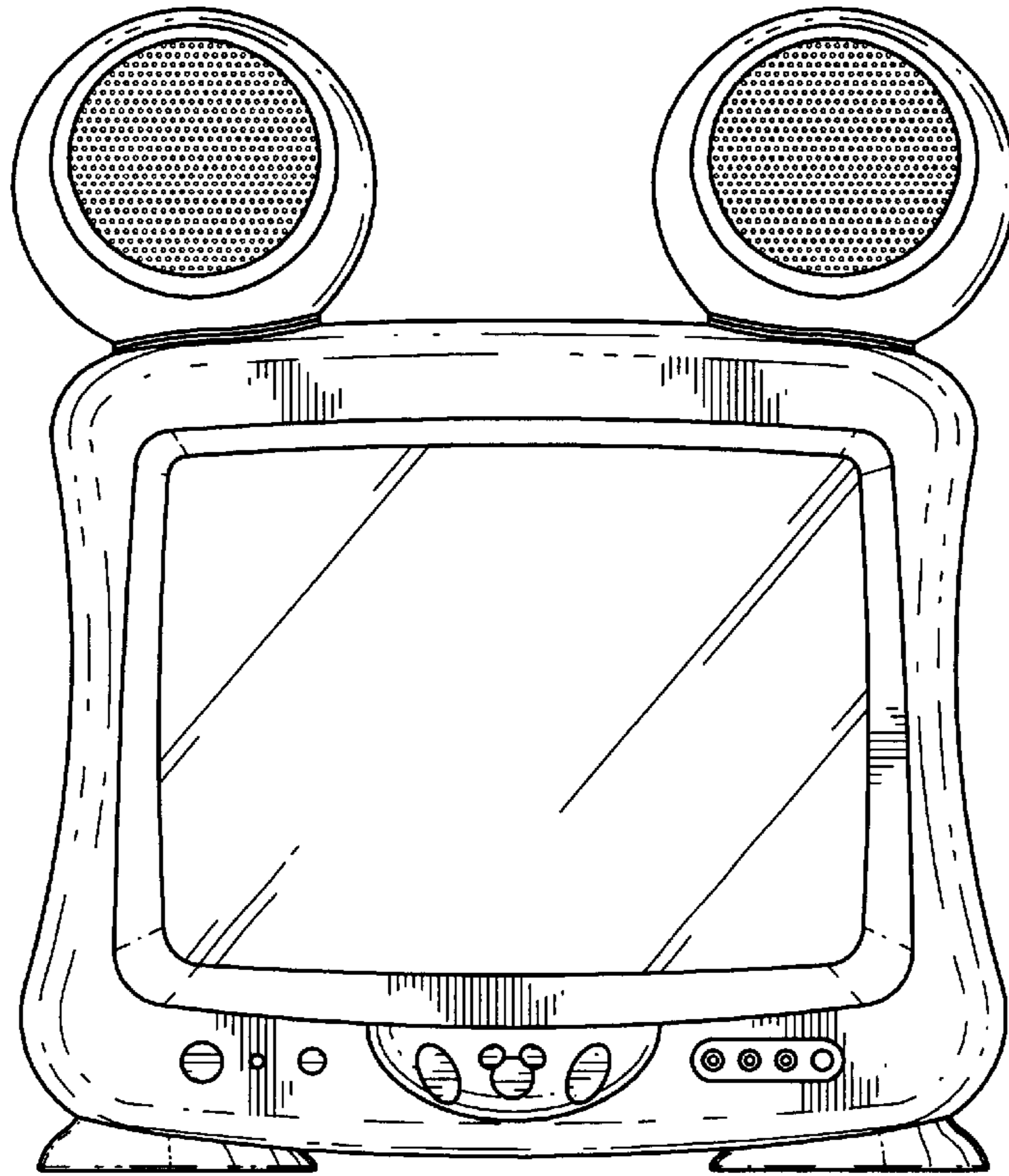
**1 Claim, 8 Drawing Sheets**



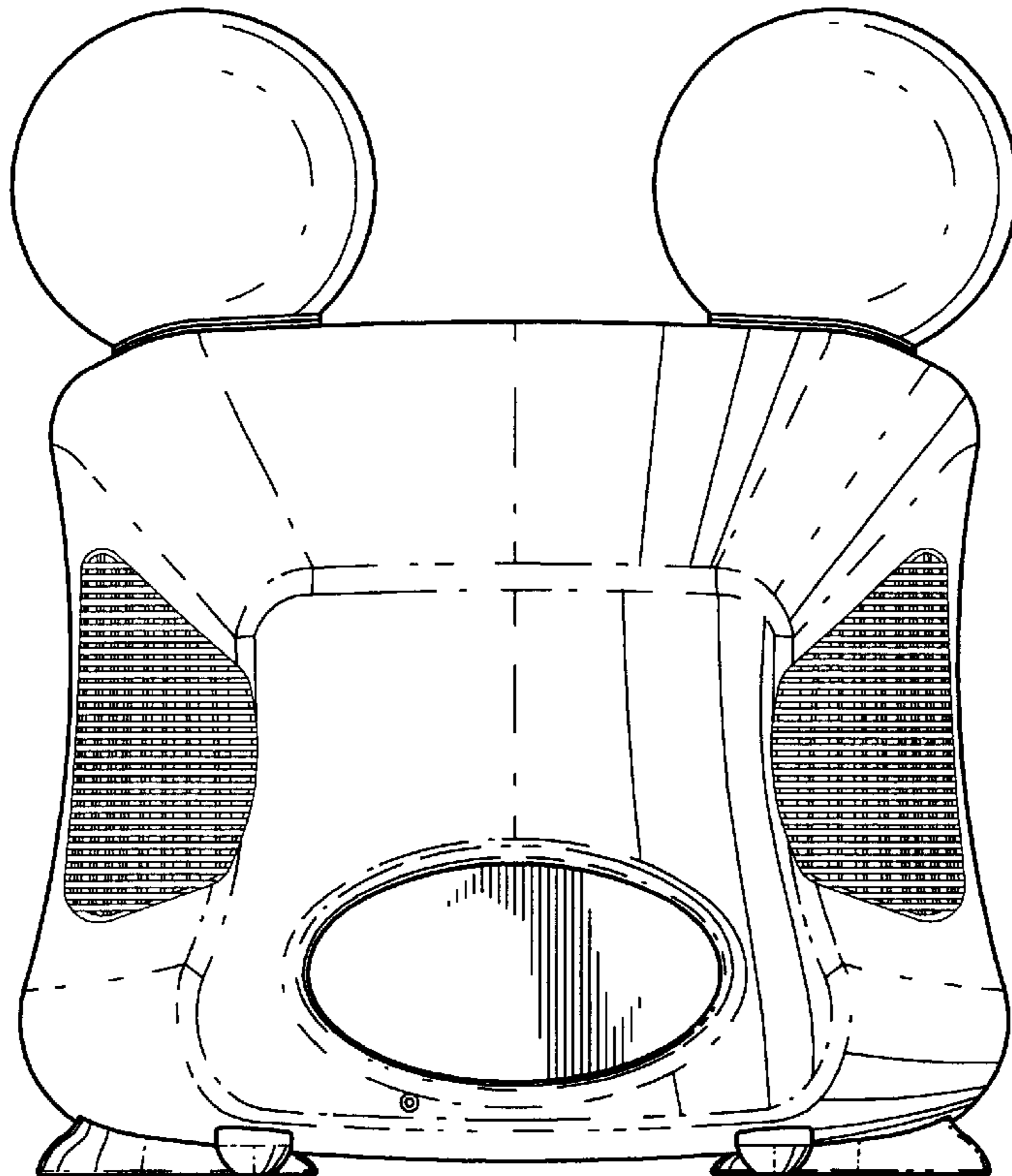


*FIG. 1*

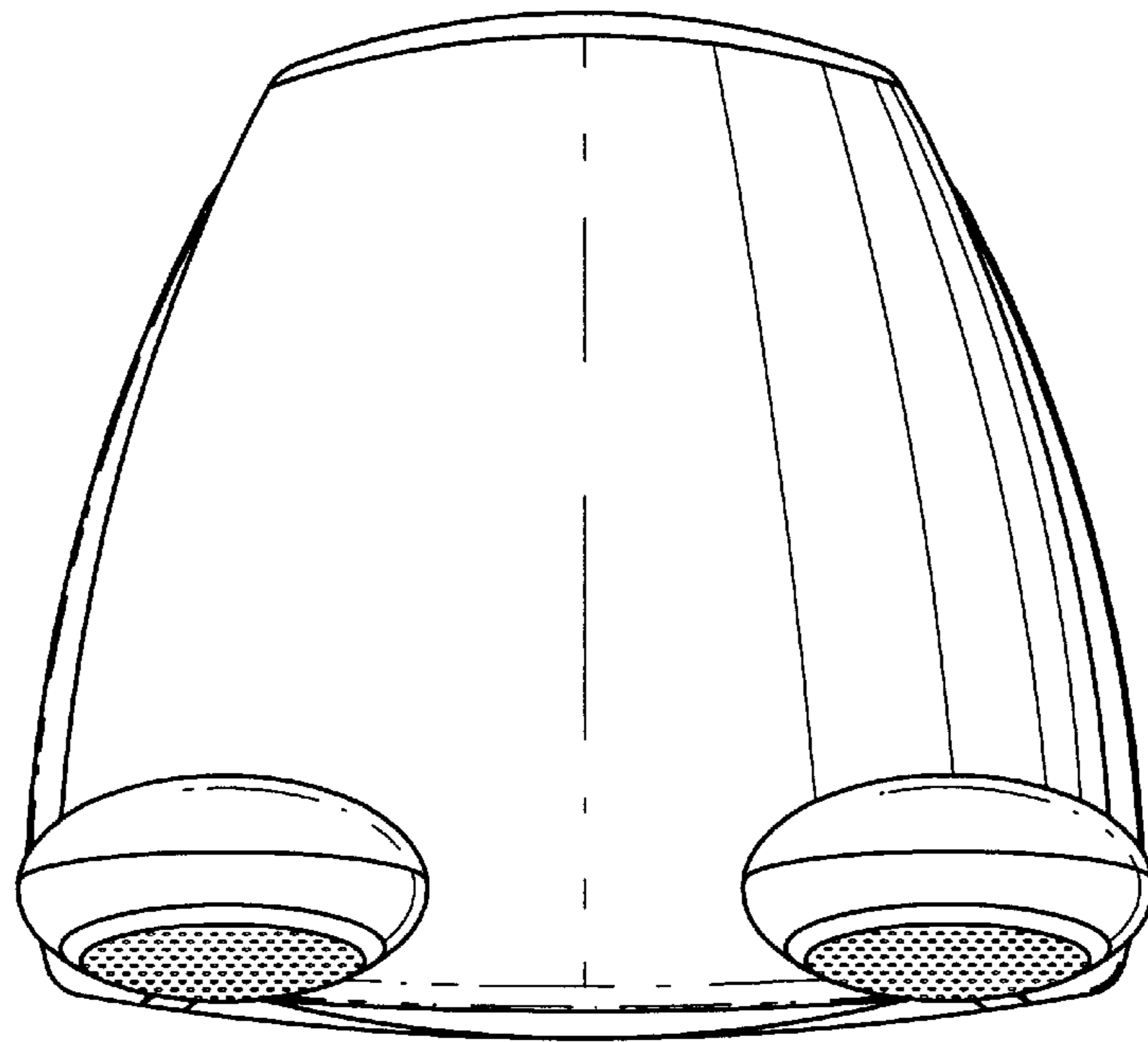
*FIG. 2*



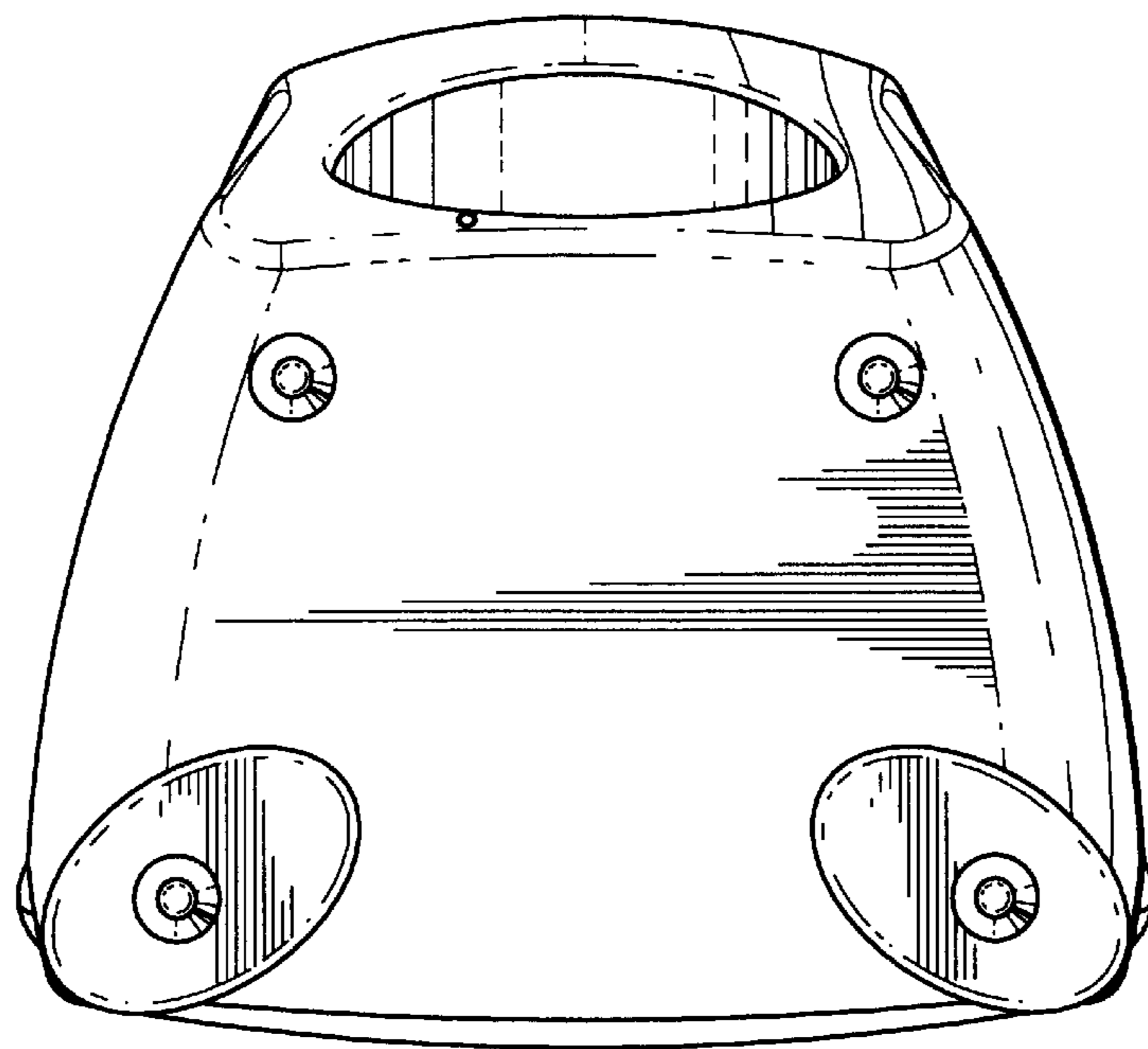
*FIG. 3*





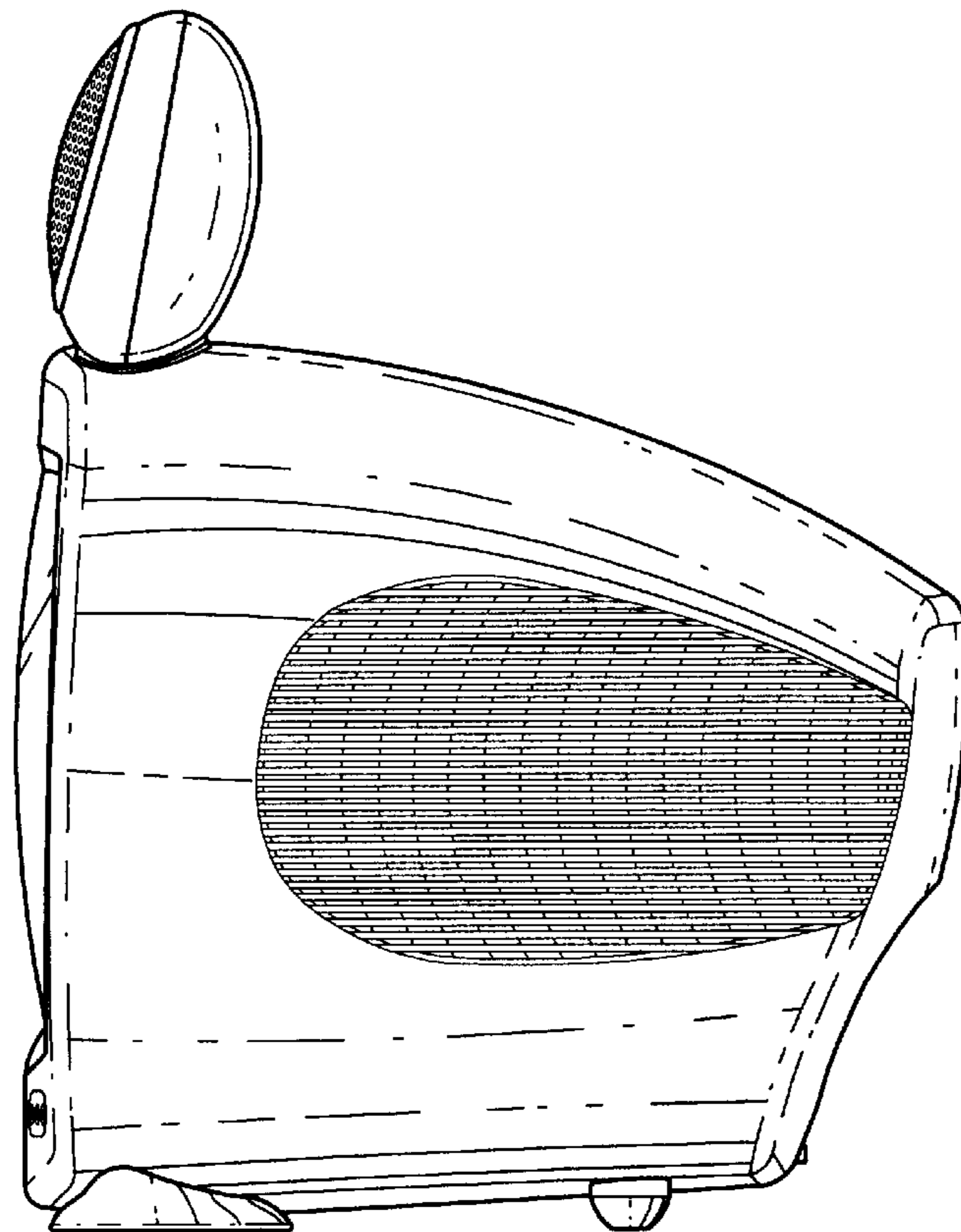
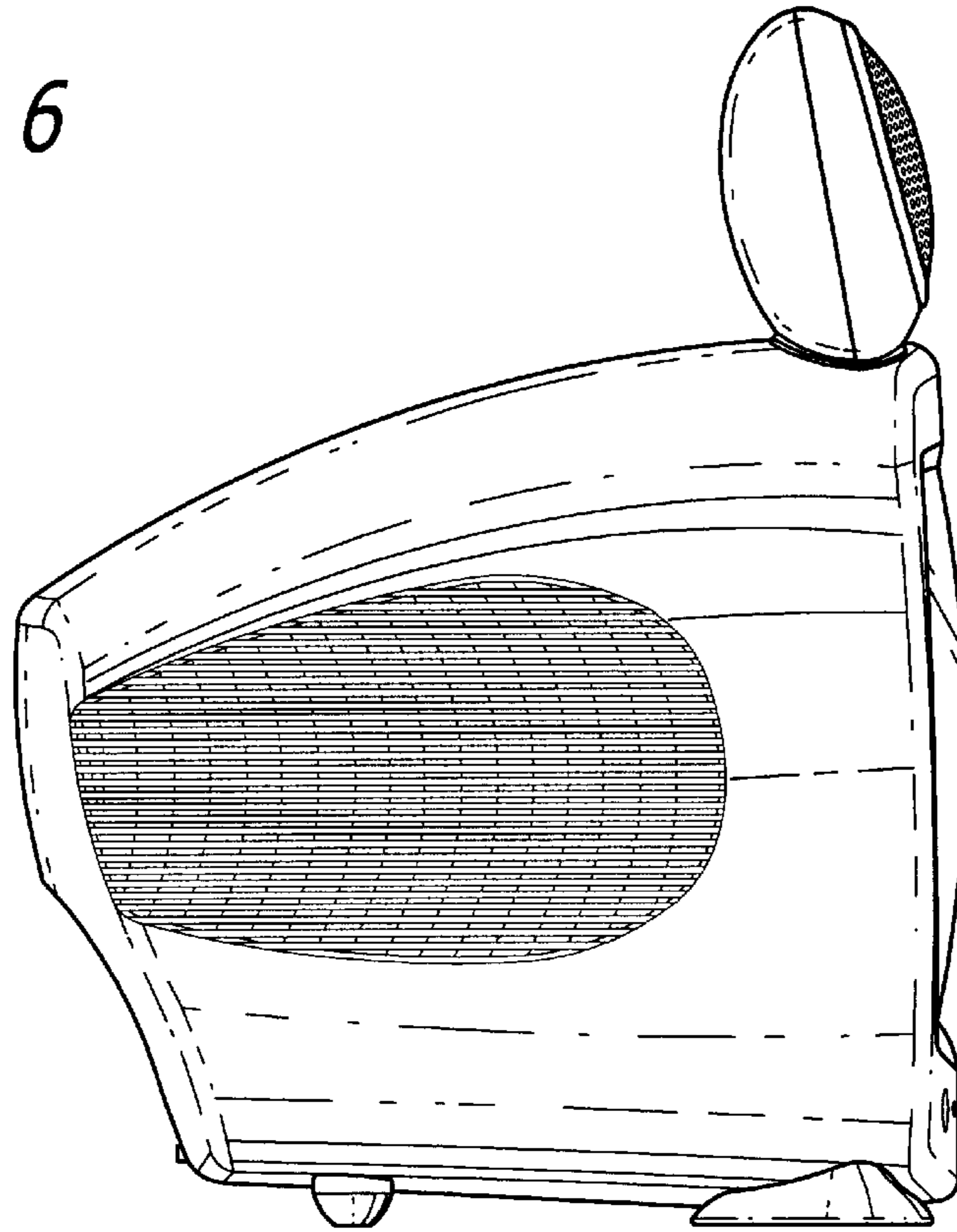


*FIG. 4*



*FIG. 5*

*FIG. 6*



*FIG. 7*

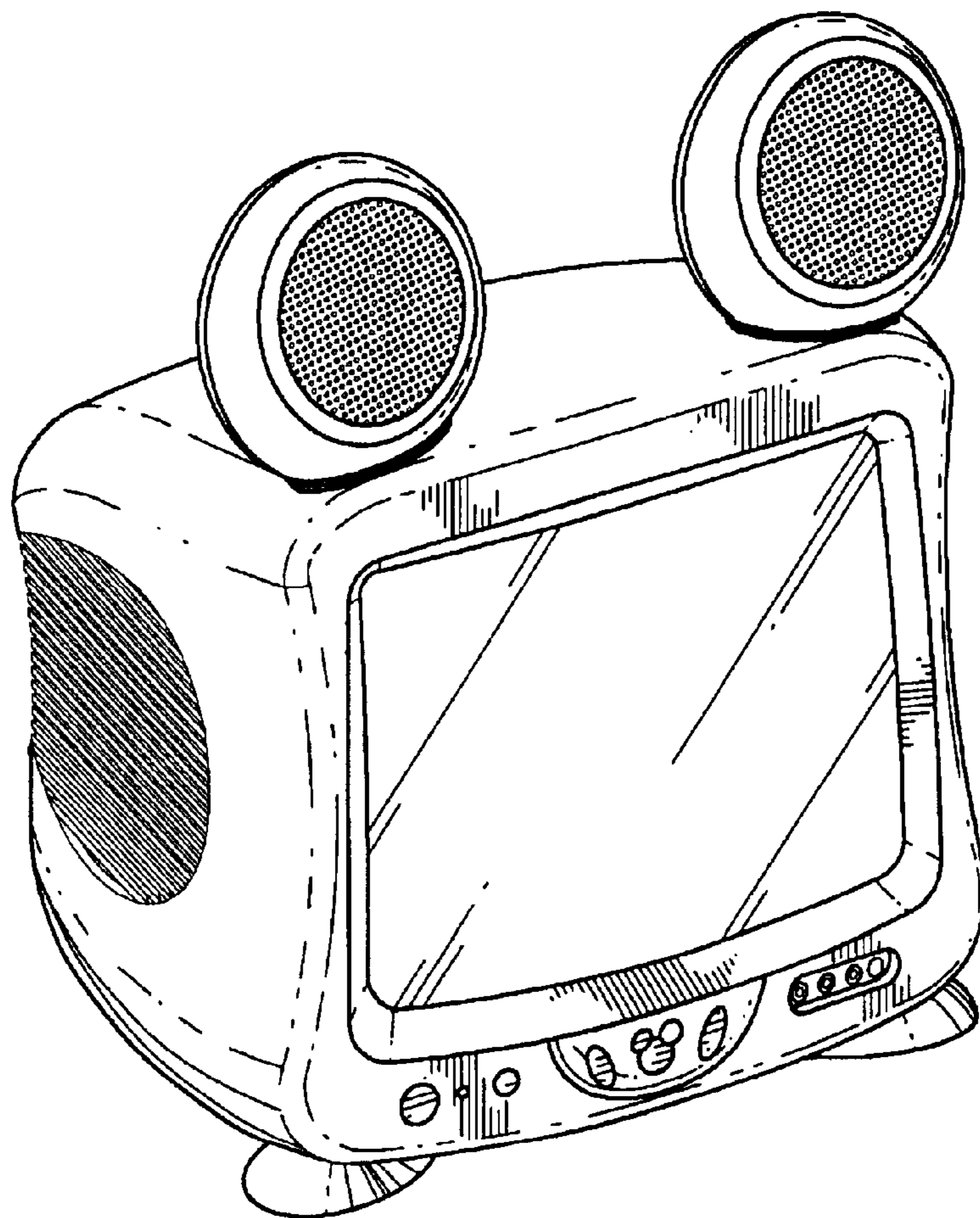
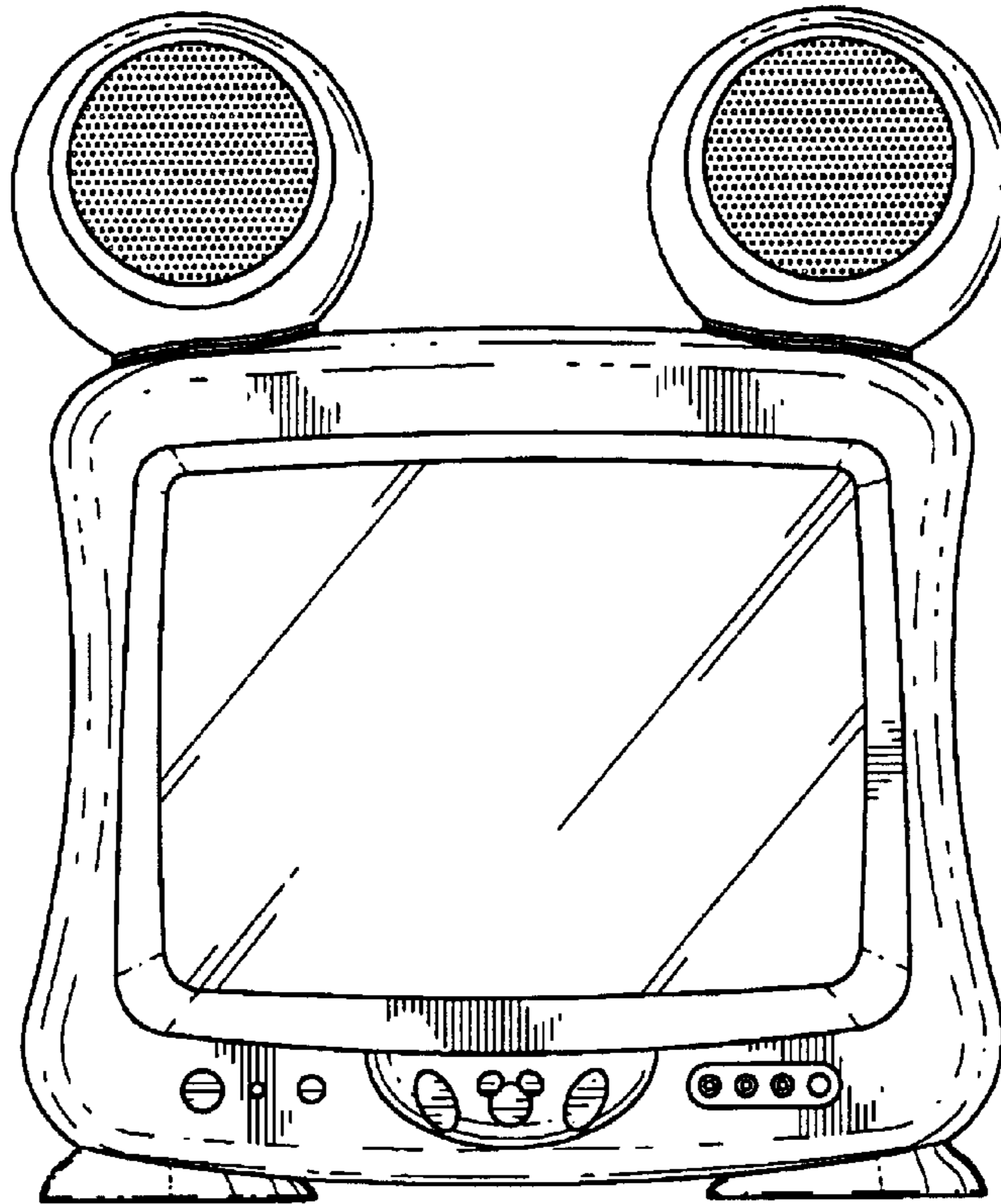
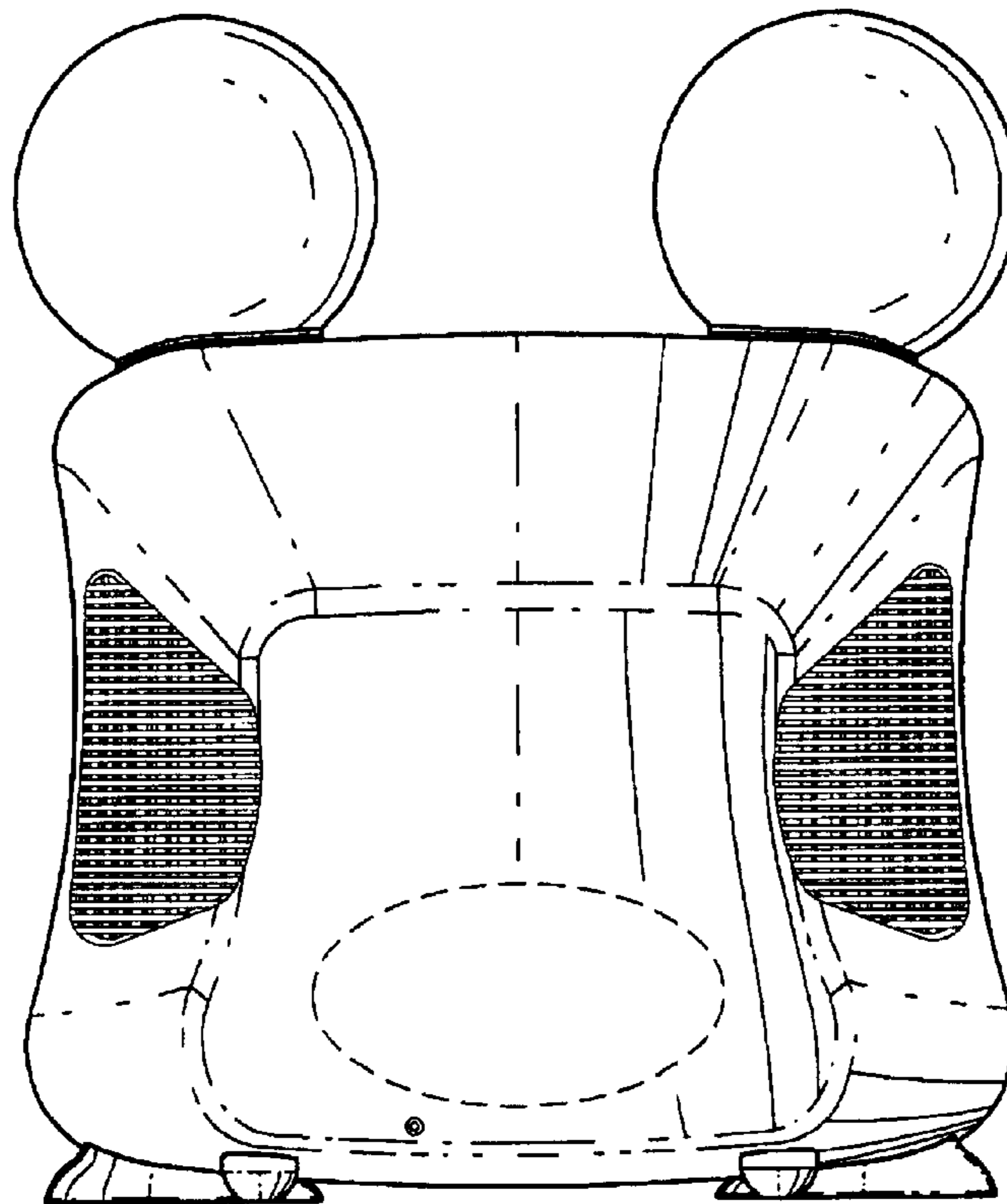


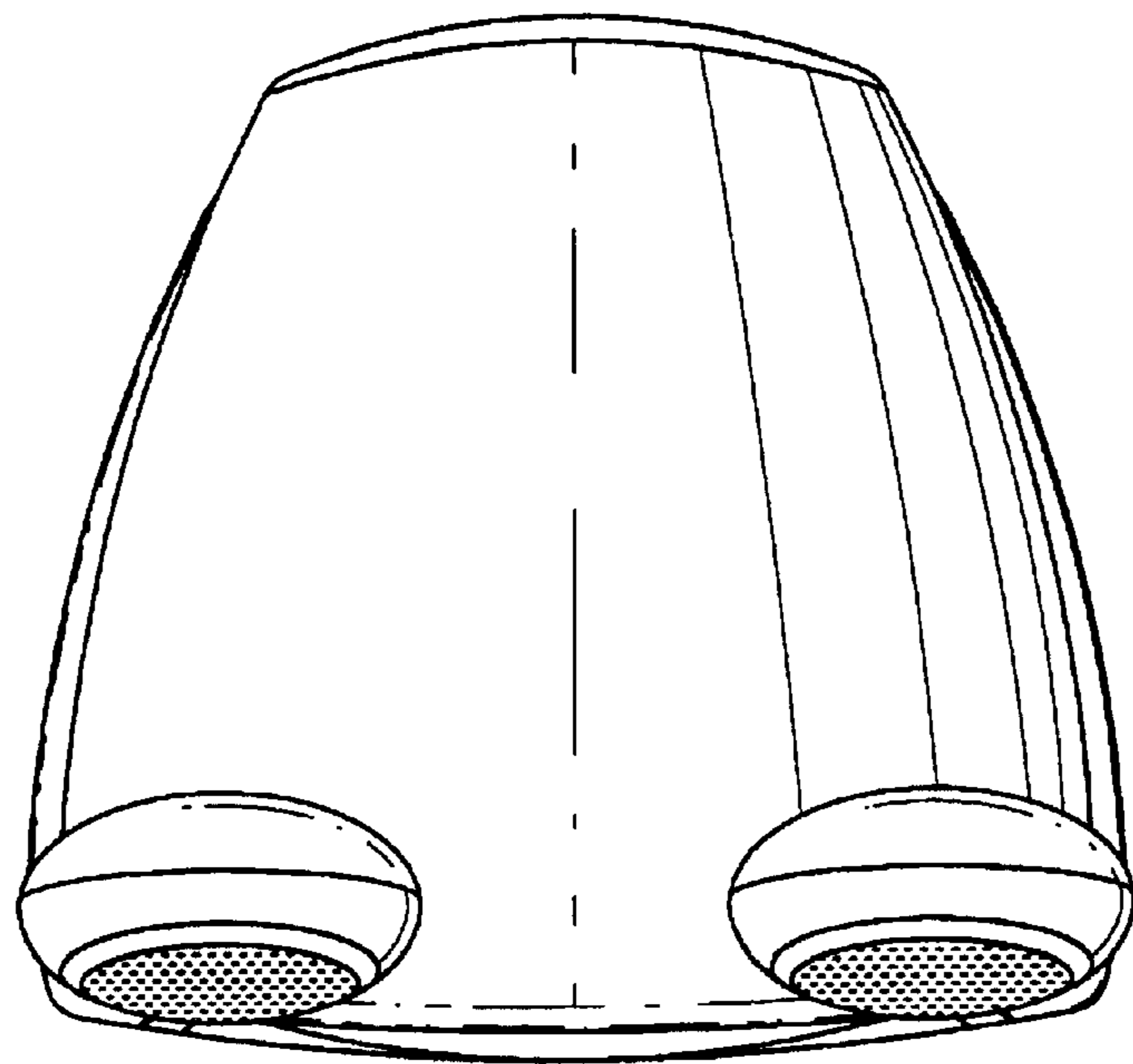
FIG. 8

*FIG. 9*

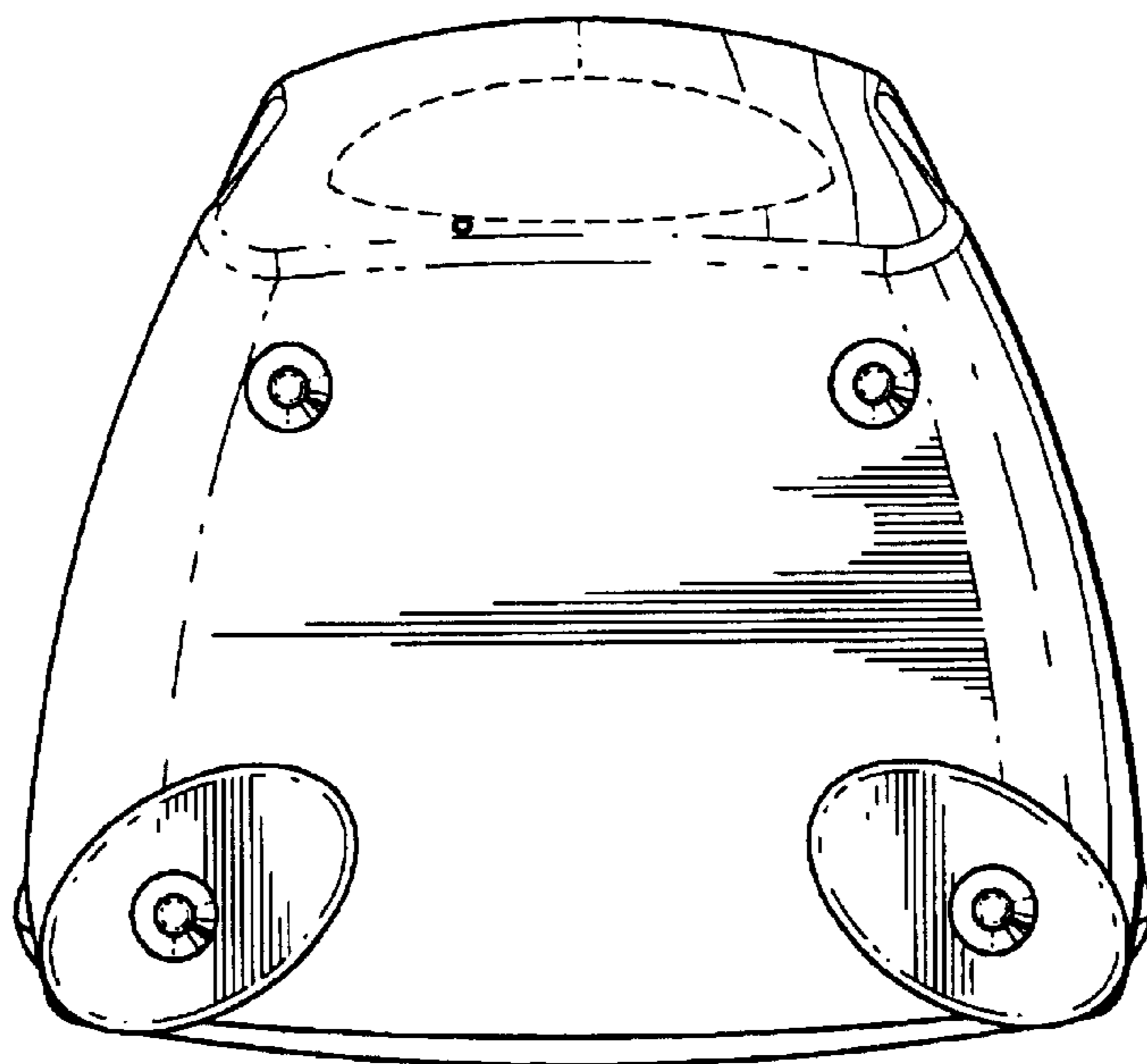


*FIG. 10*





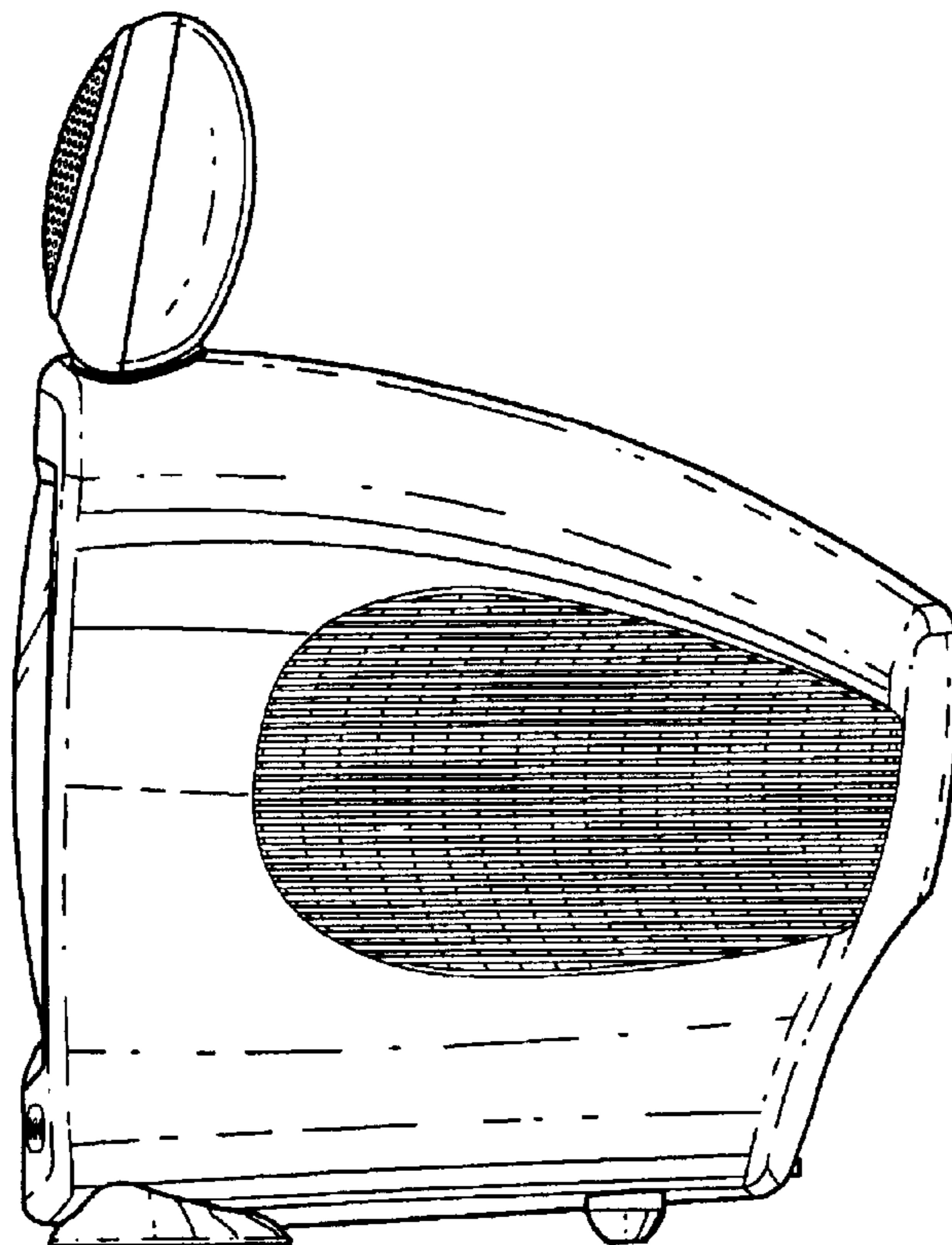
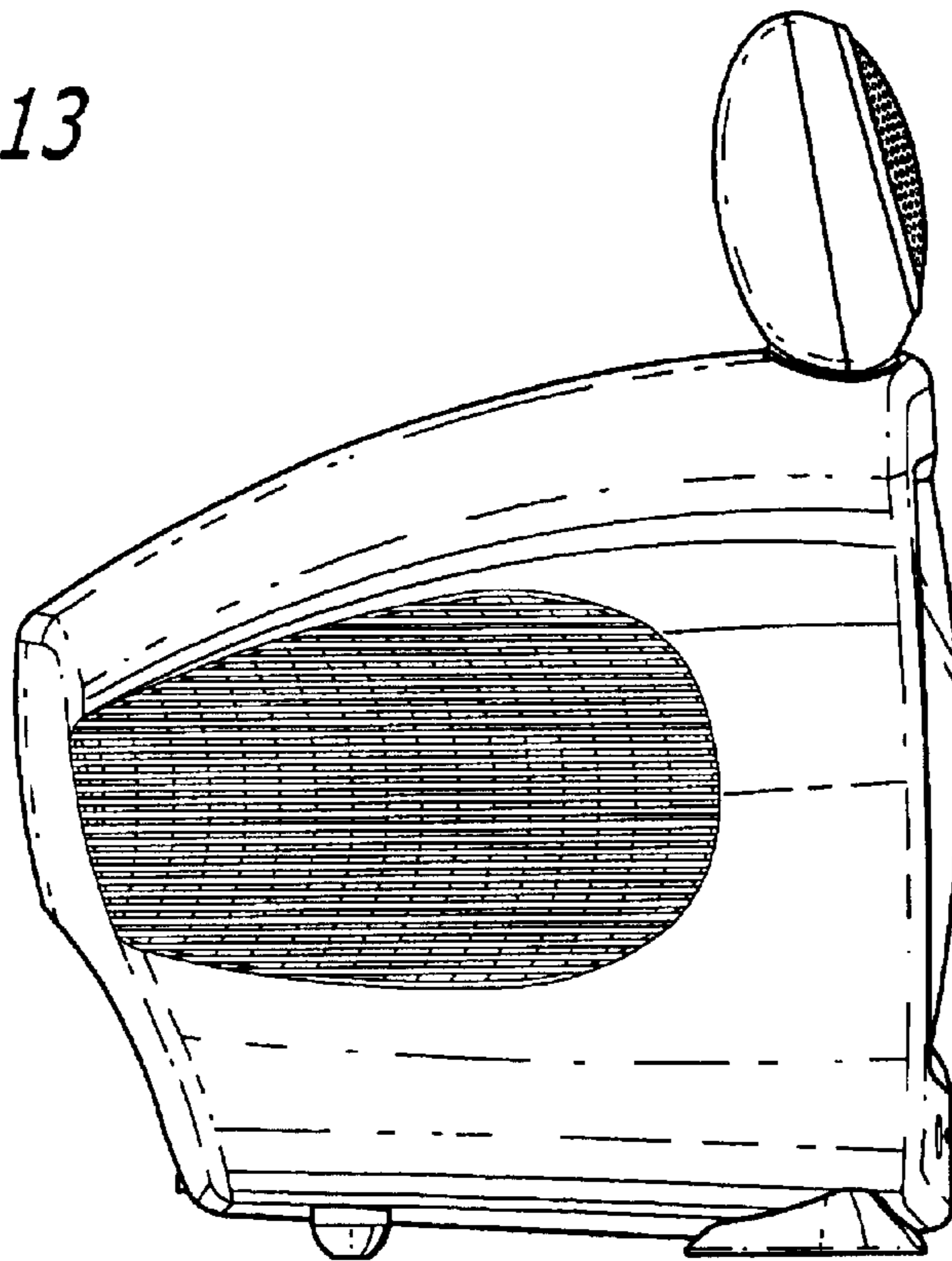
*FIG. 11*



*FIG. 12*



*FIG. 13*



*FIG. 14*