



US00D536570S

(12) **United States Design Patent**
Lo

(10) **Patent No.:** **US D536,570 S**

(45) **Date of Patent:** **** Feb. 13, 2007**

(54) **ELECTRIC MIXER**

(75) **Inventor:** **Yui-Ming Lo, Kowloon (CN)**

(73) **Assignee:** **Goodhome Products Limited, Hong Kong (HK)**

(**) **Term:** **14 Years**

(21) **Appl. No.:** **29/252,283**

(22) **Filed:** **Jan. 19, 2006**

(51) **LOC (8) Cl.** **31-00**

(52) **U.S. Cl.** **D7/379**

(58) **Field of Classification Search** D7/376-386,
D7/412-414, 673, 678, 693, 300.1; 99/348,
99/492; 241/33, 36, 37.5, 101.01, 101.1,
241/101, 199, 101.2, 168, 169.1, 291, 199.12,
241/279, 282.1, 292.1; 366/64-67, 129, 98,
366/100, 130, 325.92-325.94, 330.1-330.5,
366/341-343, 146, 192, 204, 241, 247, 279,
366/282, 318, 325.3, 327.2, 328.2, 329.1

See application file for complete search history.

(56) **References Cited**

U.S. PATENT DOCUMENTS

- 4,334,724 A * 6/1982 Rogers, Sr. 312/280
- D278,506 S * 4/1985 Kafka D7/376
- 4,575,255 A * 3/1986 Kafka 366/129
- D320,717 S * 10/1991 O'Brien D7/384
- D390,415 S * 2/1998 Hippen et al. D7/412
- 5,979,850 A * 11/1999 Hippen et al. 249/309.2
- D453,664 S * 2/2002 Brady D7/598

- D462,569 S * 9/2002 Chin D7/376
- D490,647 S * 6/2004 Buesching D7/379
- D495,186 S * 8/2004 Poupel et al. D7/300.1
- D500,631 S * 1/2005 Ranzoni D7/376
- D511,930 S * 11/2005 Wong D7/376

* cited by examiner

Primary Examiner—Cathron C. Brooks

Assistant Examiner—Ricky Pham

(74) *Attorney, Agent, or Firm*—Alix, Yale & Ristas, LLP

(57) **CLAIM**

The ornamental design for a electric mixer, as shown and described.

DESCRIPTION

FIG. 1 is a front elevational view of a electric mixer showing my new design;
 FIG. 2 is a left side elevational view thereof;
 FIG. 3 is a top plan view thereof;
 FIG. 4 is a rear elevational view thereof;
 FIG. 5 is a right side elevational view thereof
 FIG. 6 is a bottom plan view thereof;
 FIG. 7 is a front view with cover separated thereof;
 FIG. 8 is a left side view with cover separated thereof;
 FIG. 9 is a rear view with cover separated thereof;
 FIG. 10 is a right side view with cover separated thereof;
 FIG. 11 is a front view with cover and parts separated thereof; and,
 FIG. 12 is a left side view with cover and parts separated thereof.

1 Claim, 6 Drawing Sheets

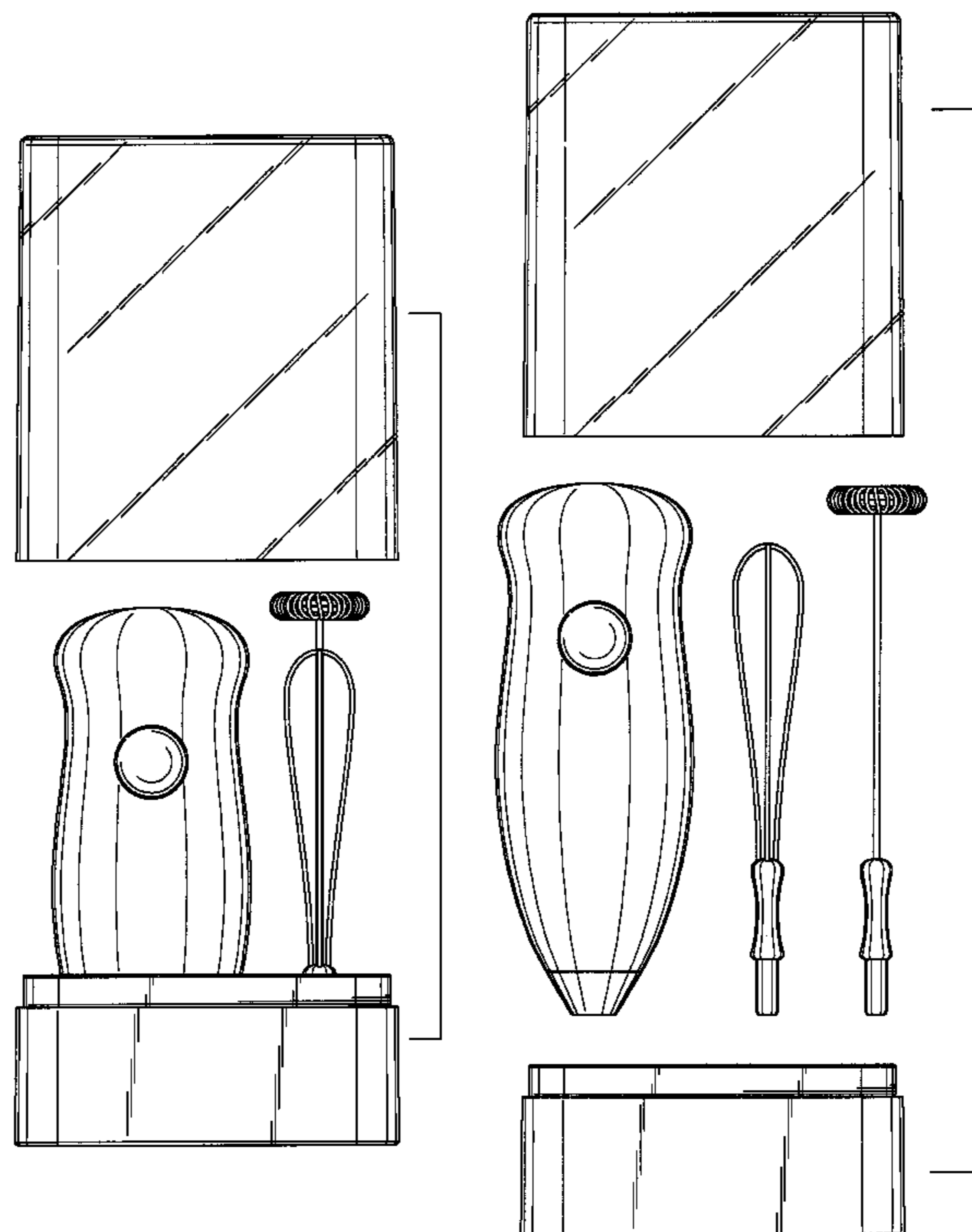

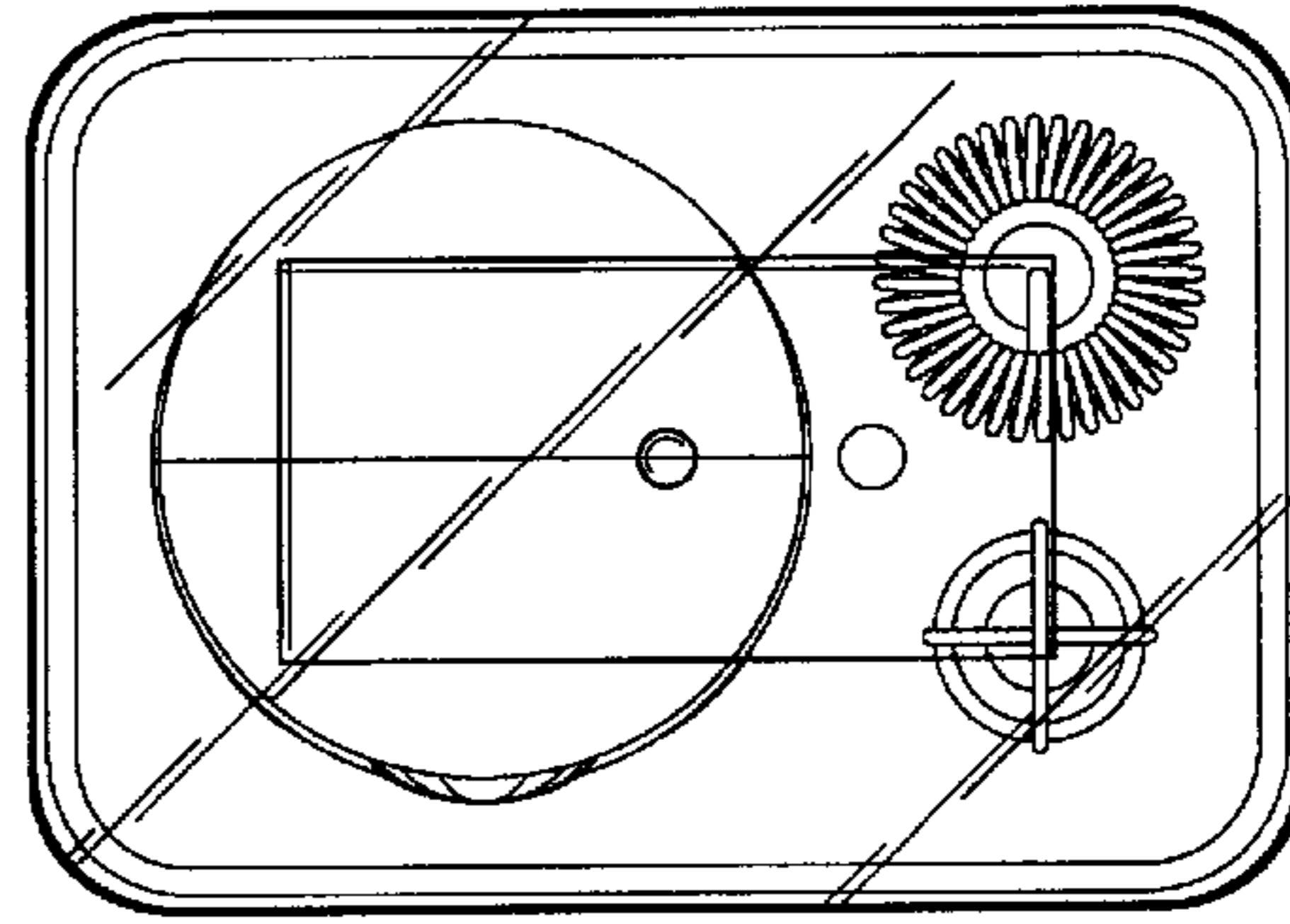

FIG. 3

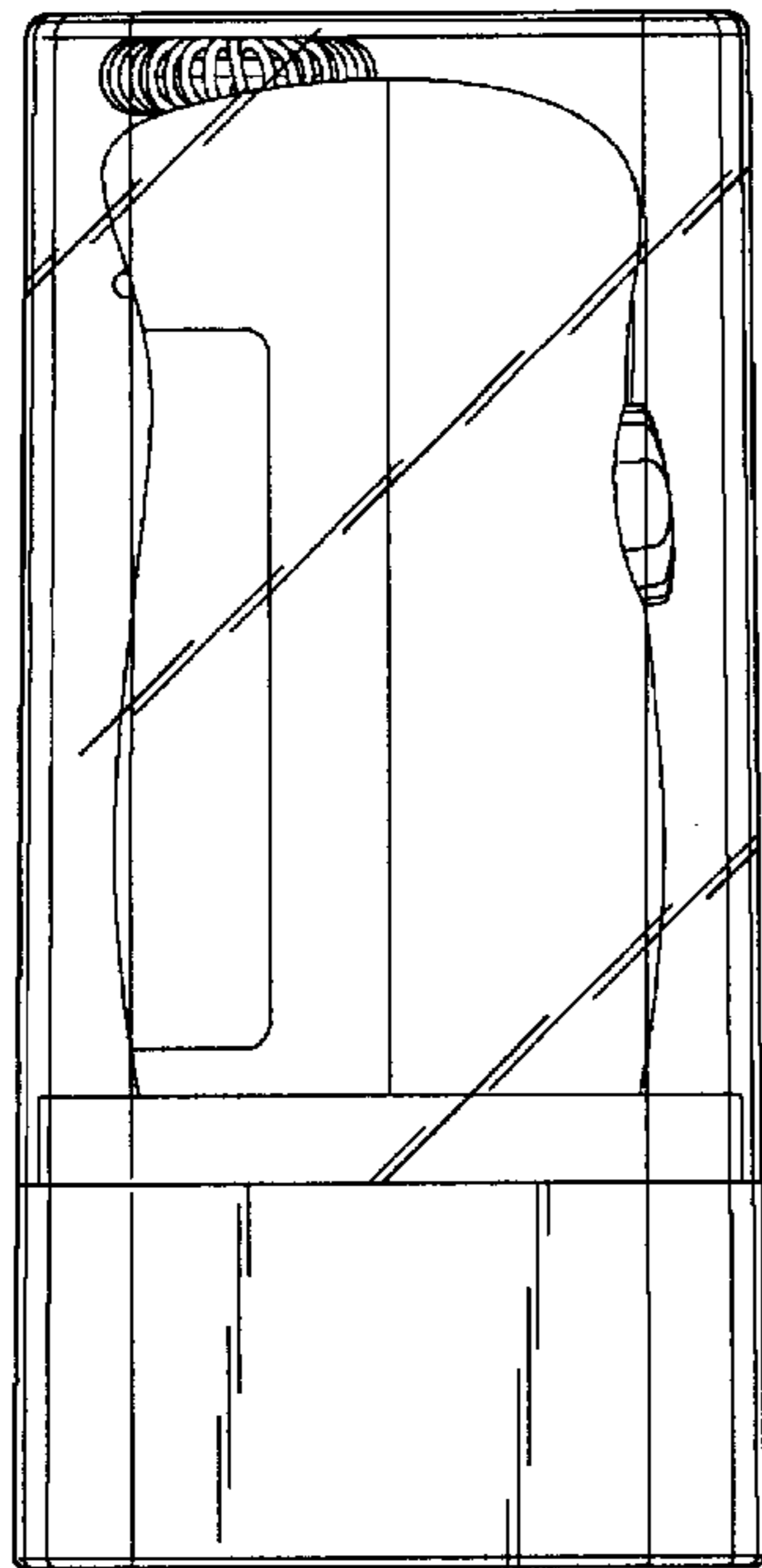

FIG. 2

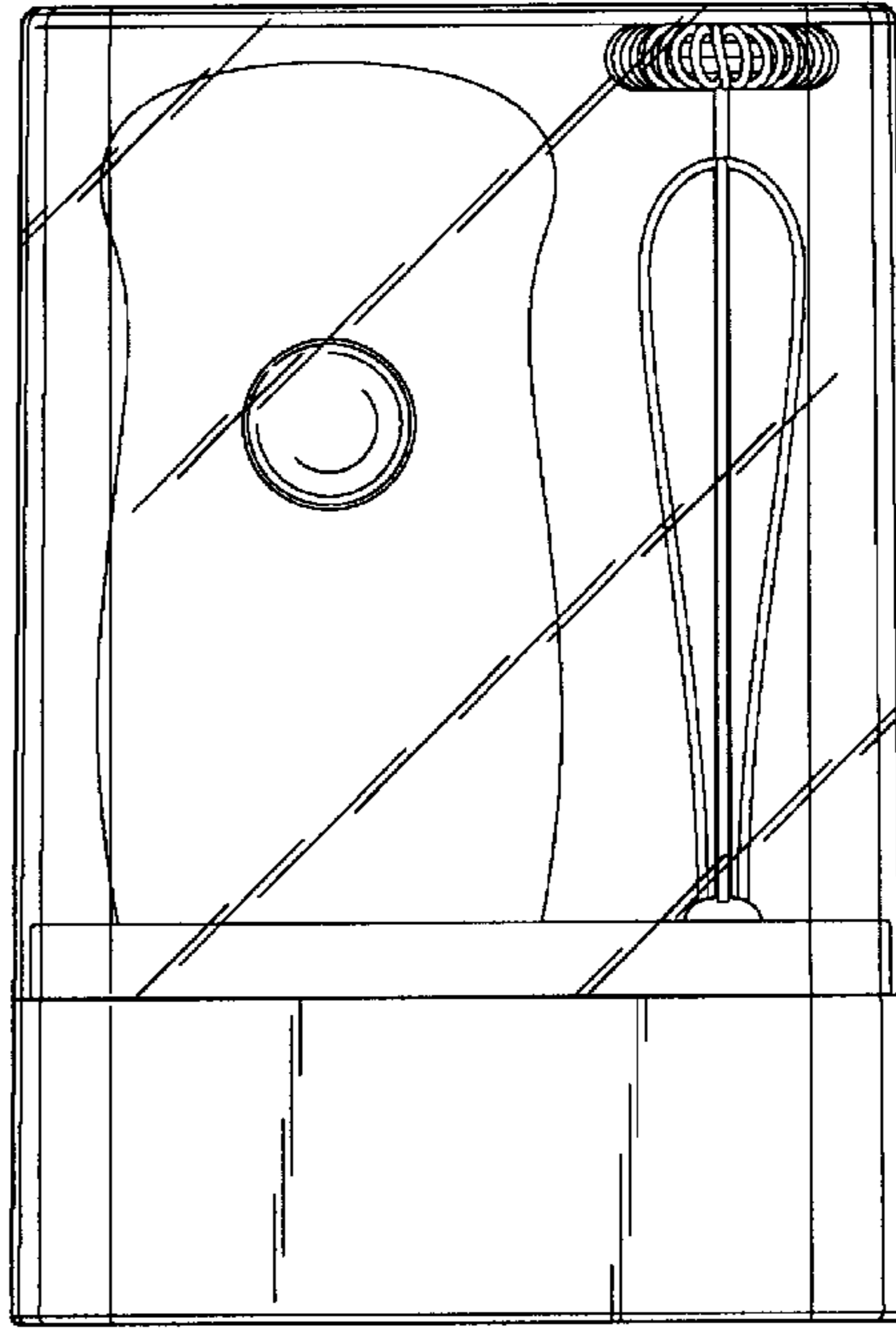

FIG. 1

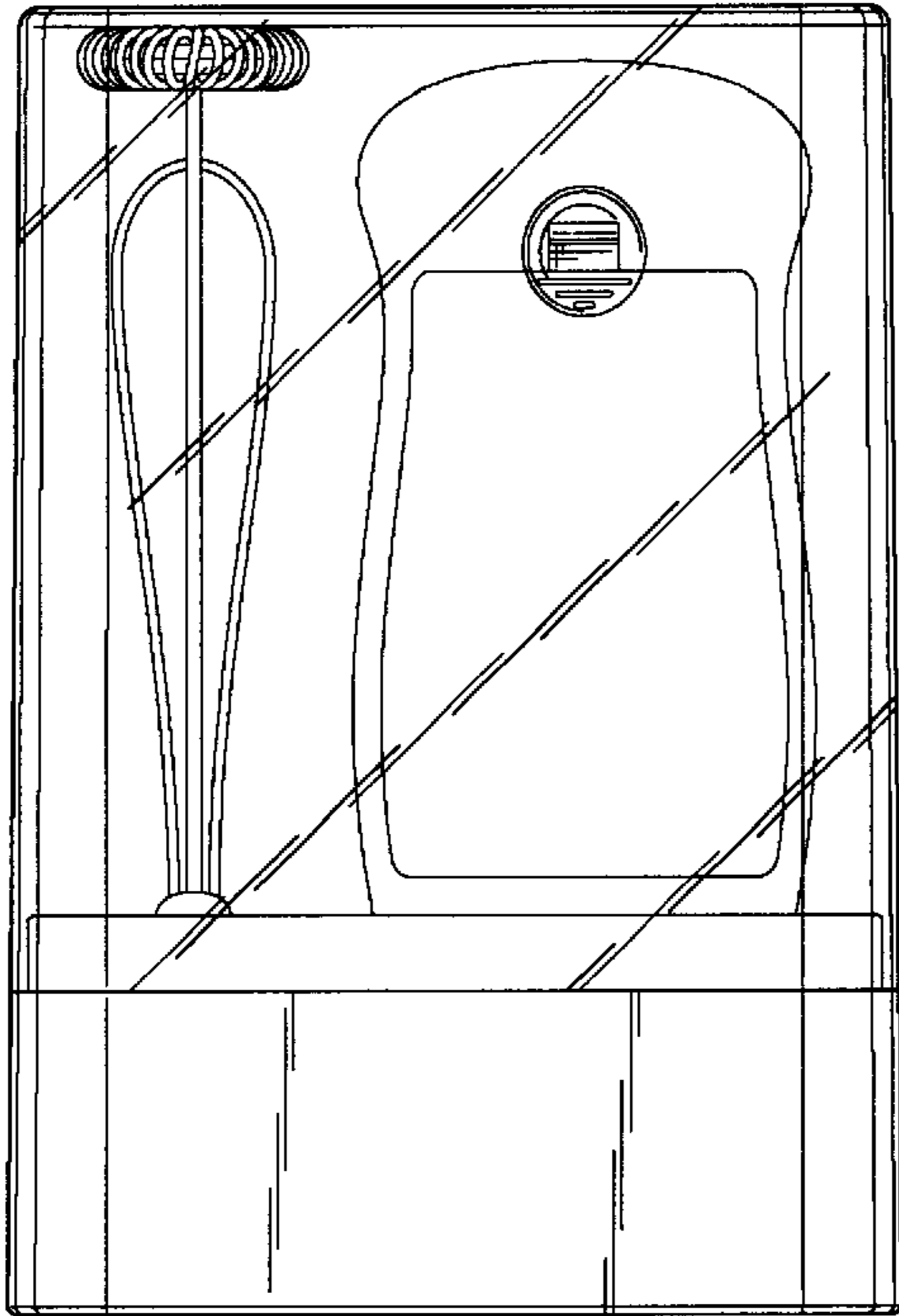

FIG. 4

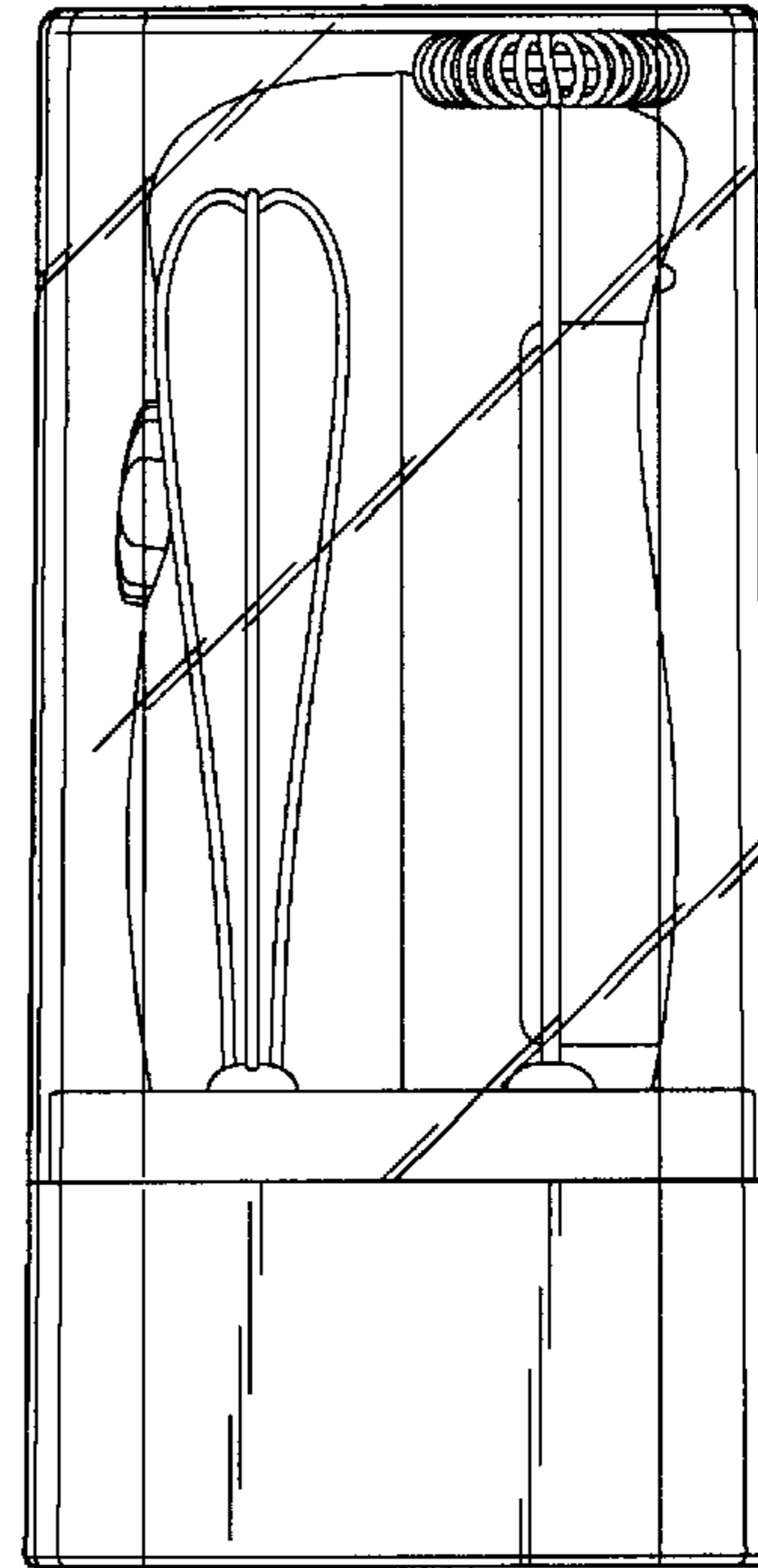

FIG. 5

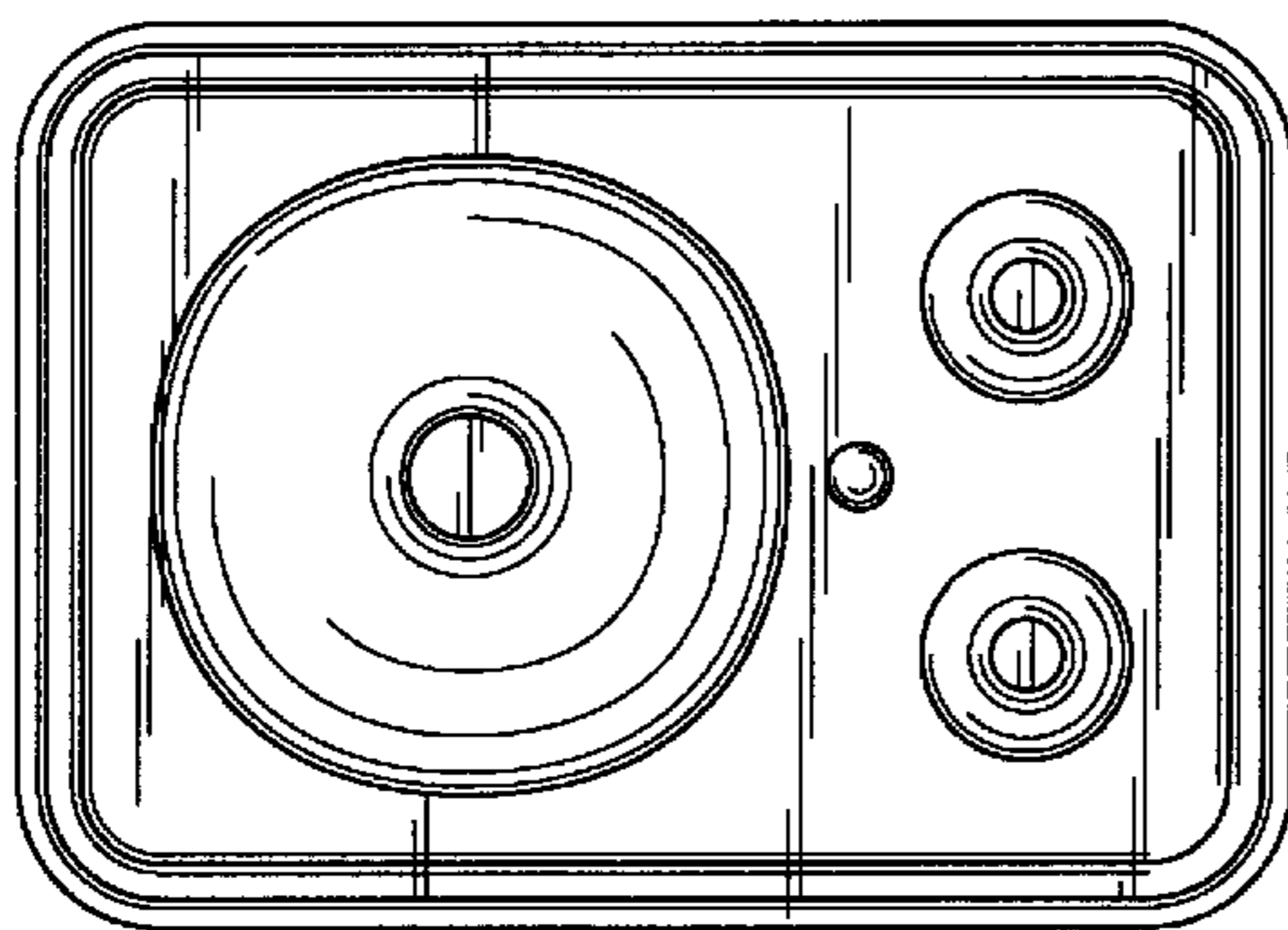

FIG. 6

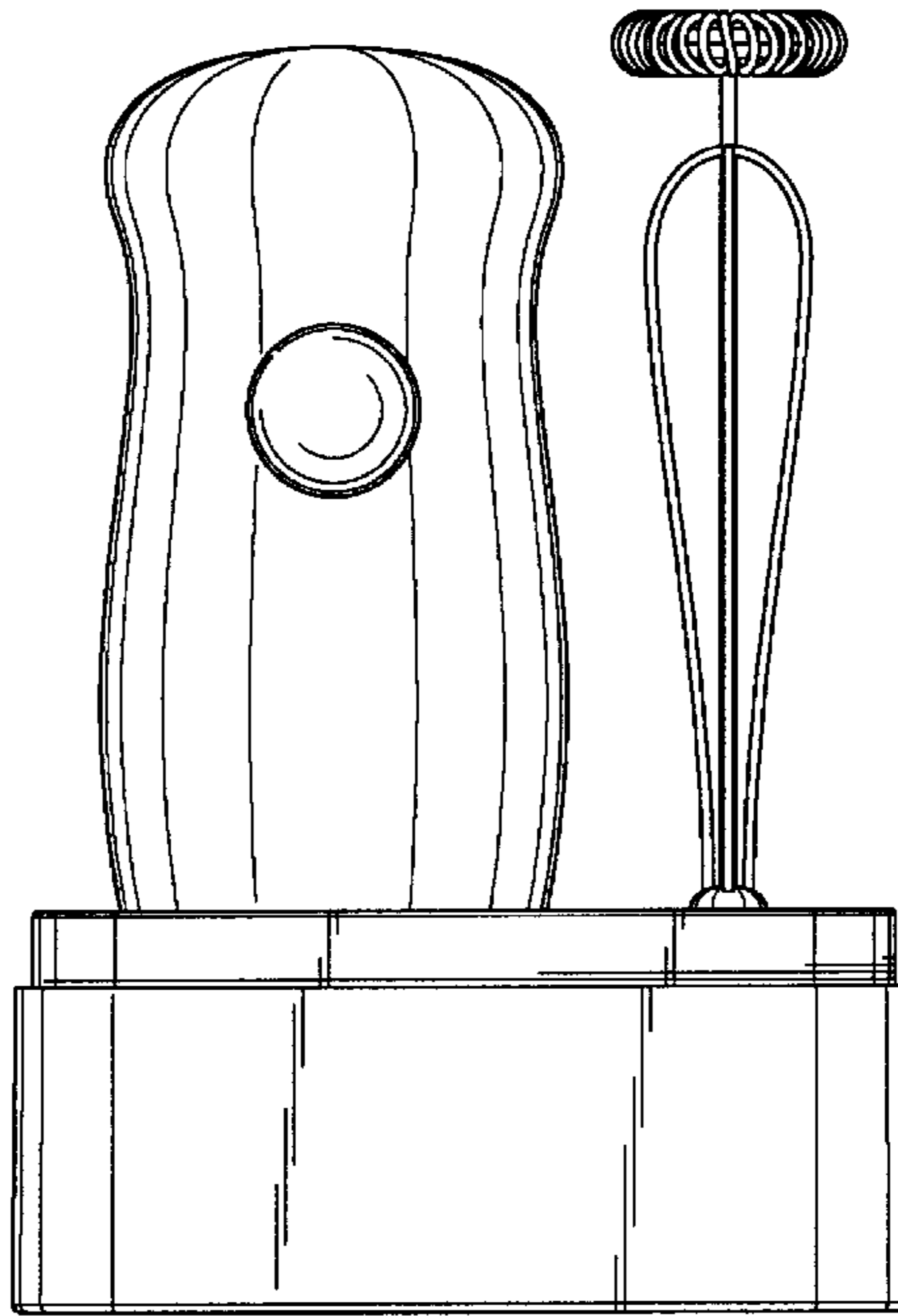
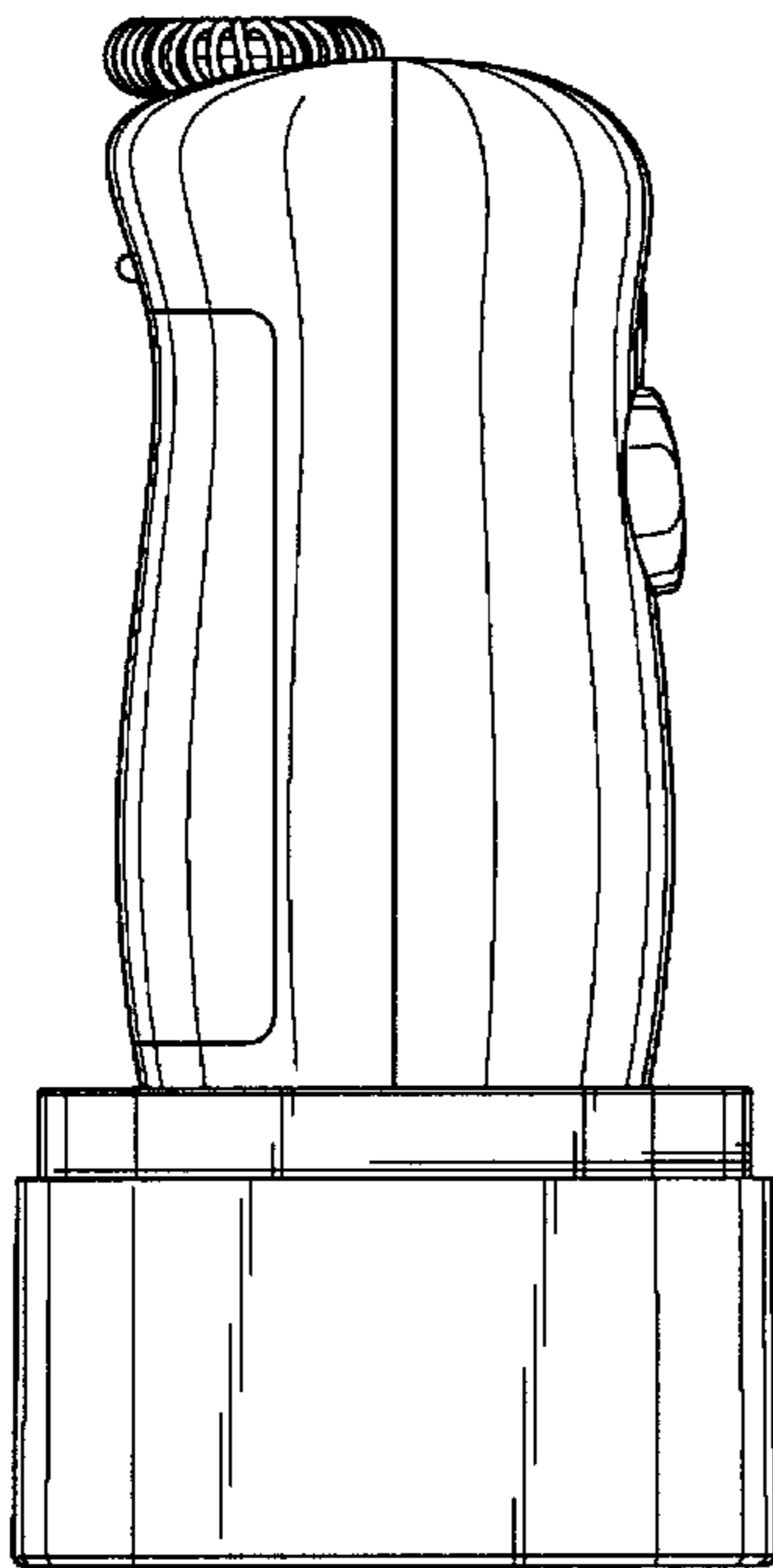
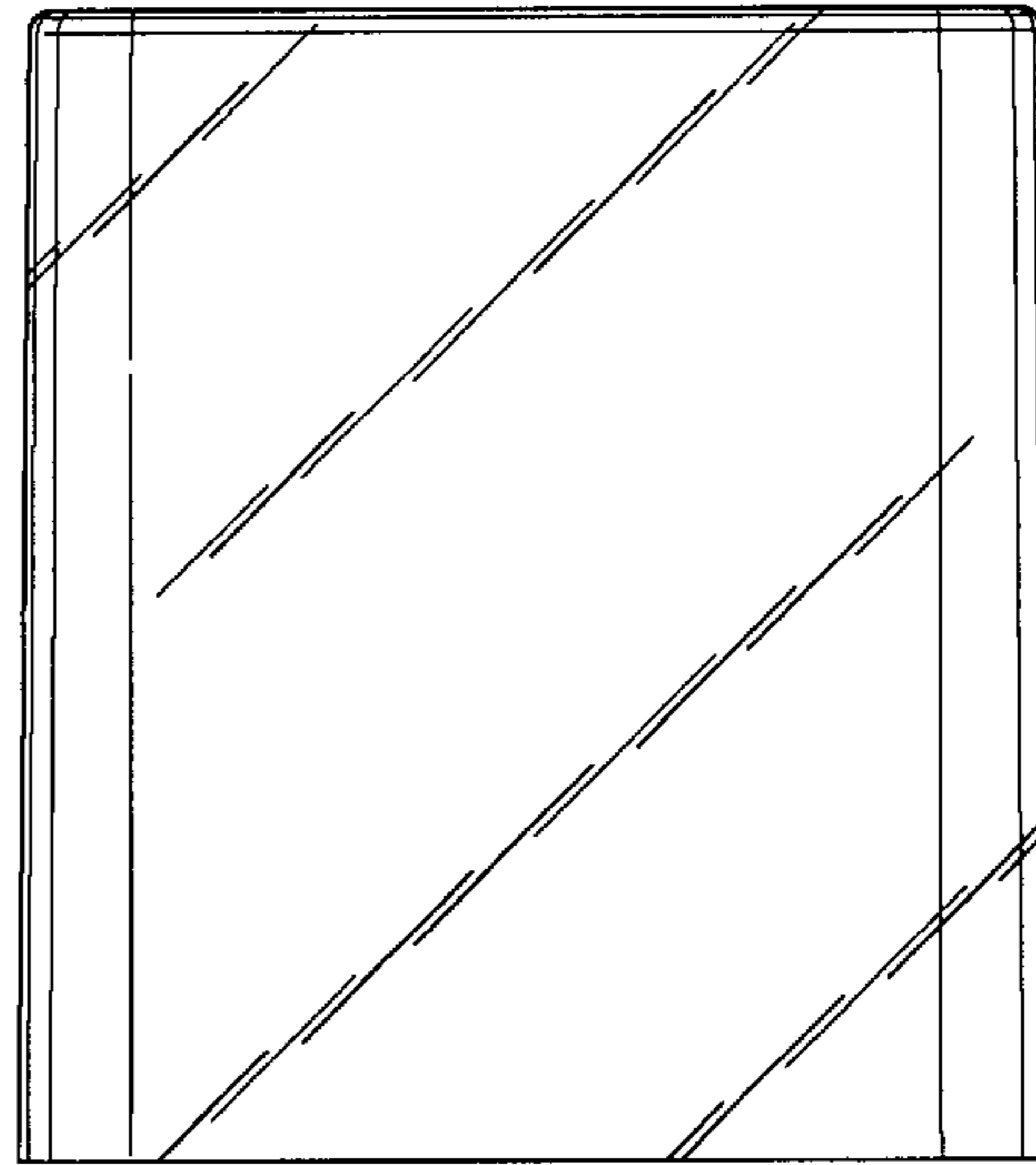
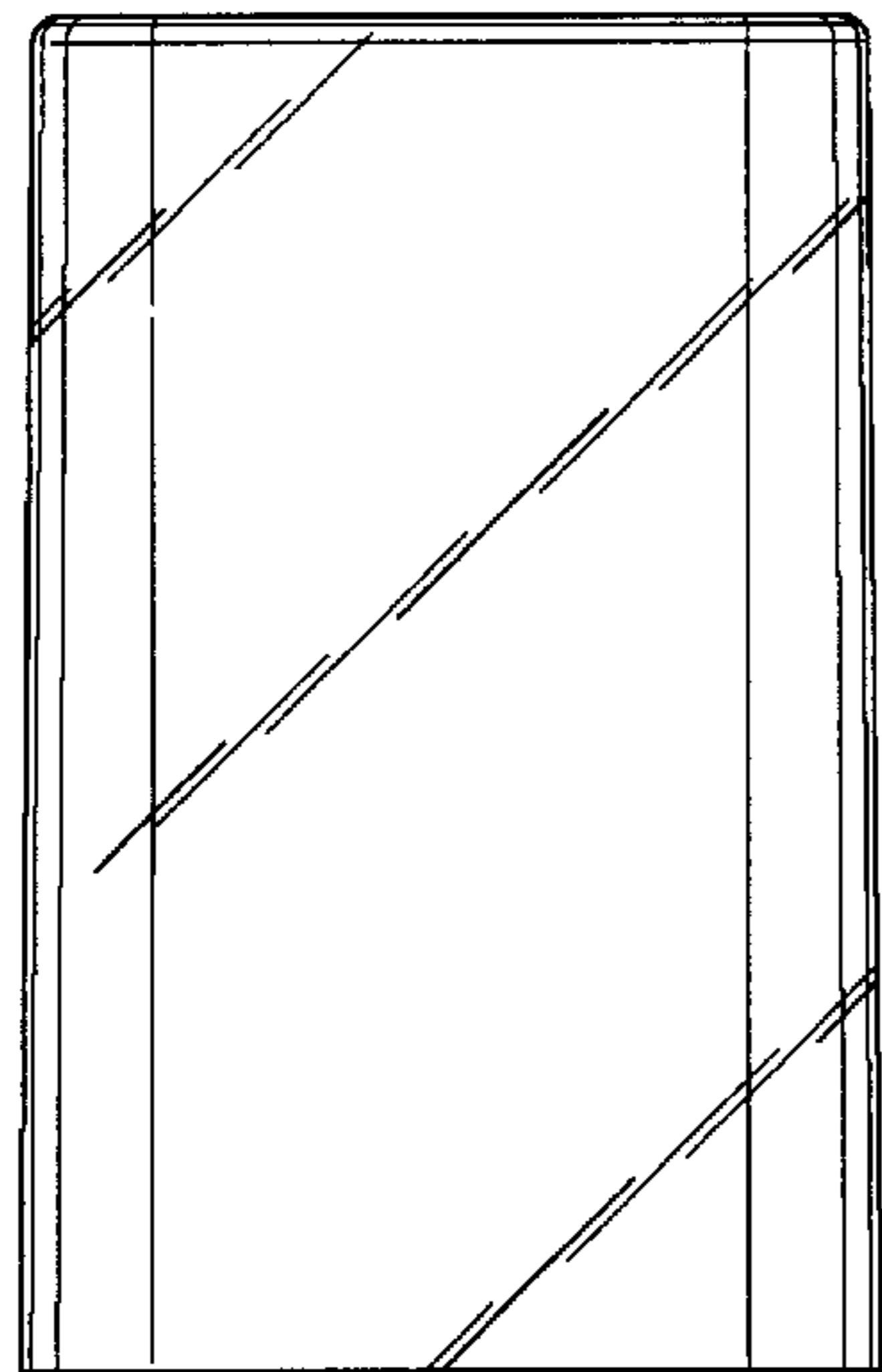

FIG. 8

FIG. 7

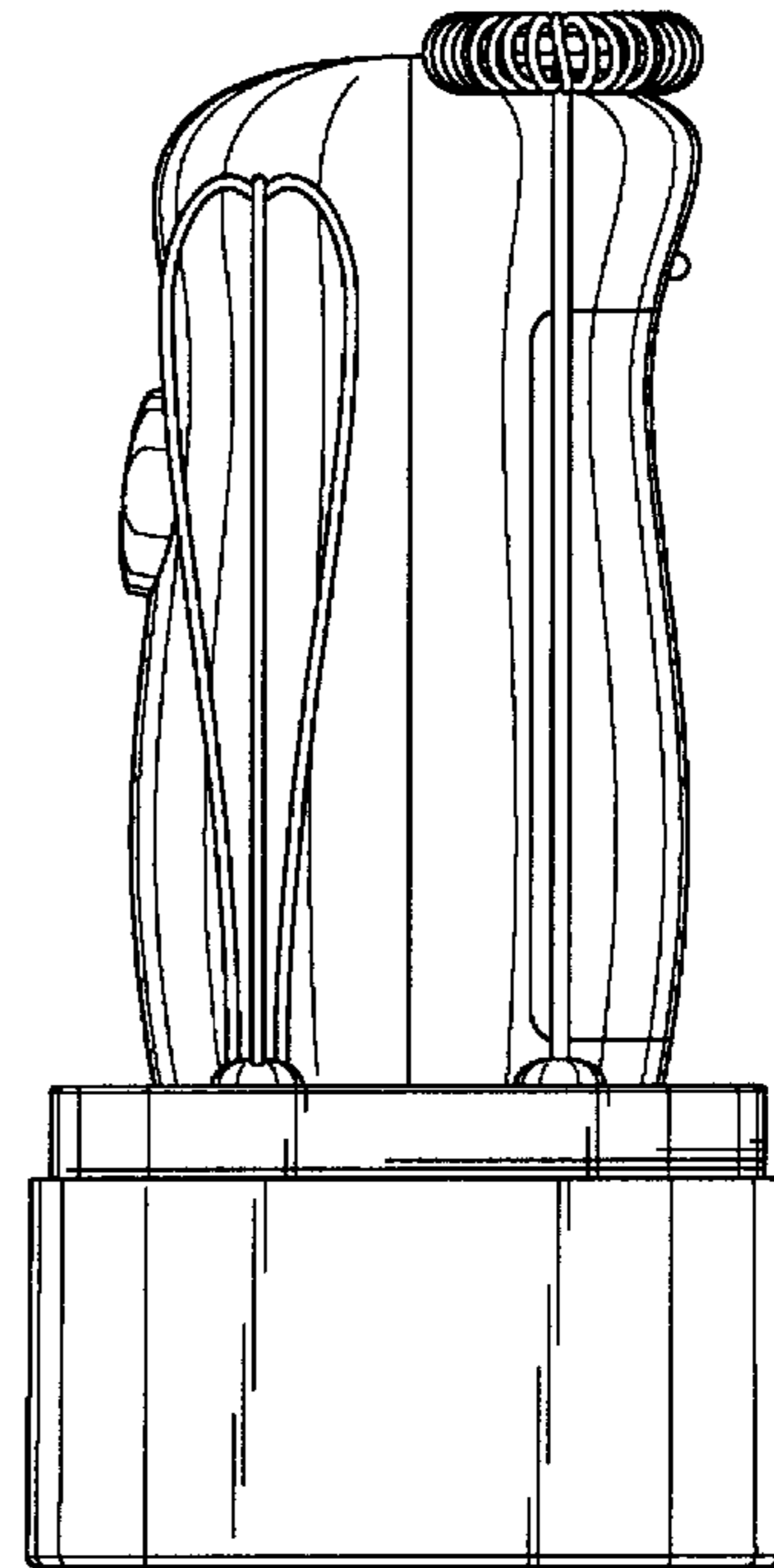
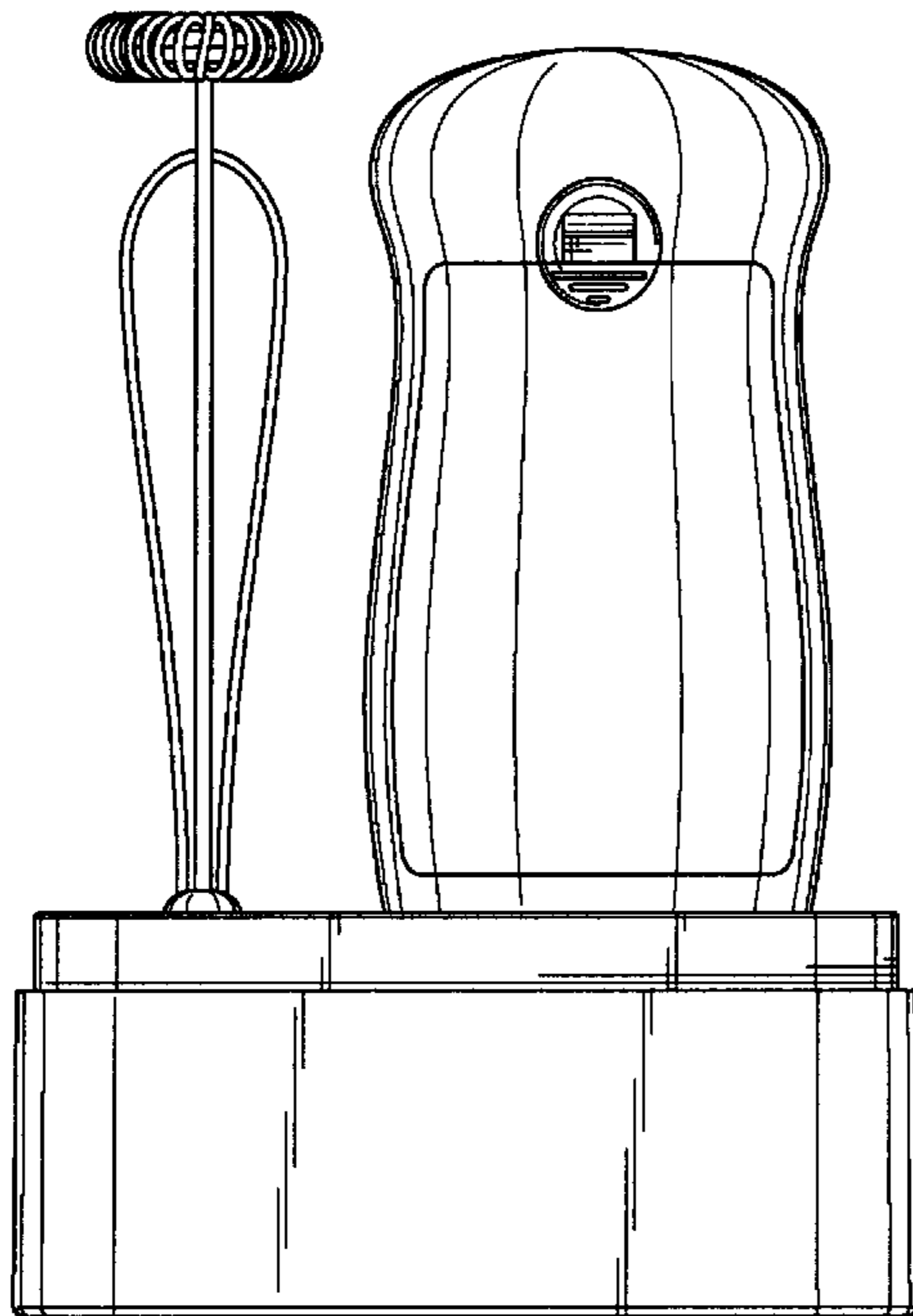
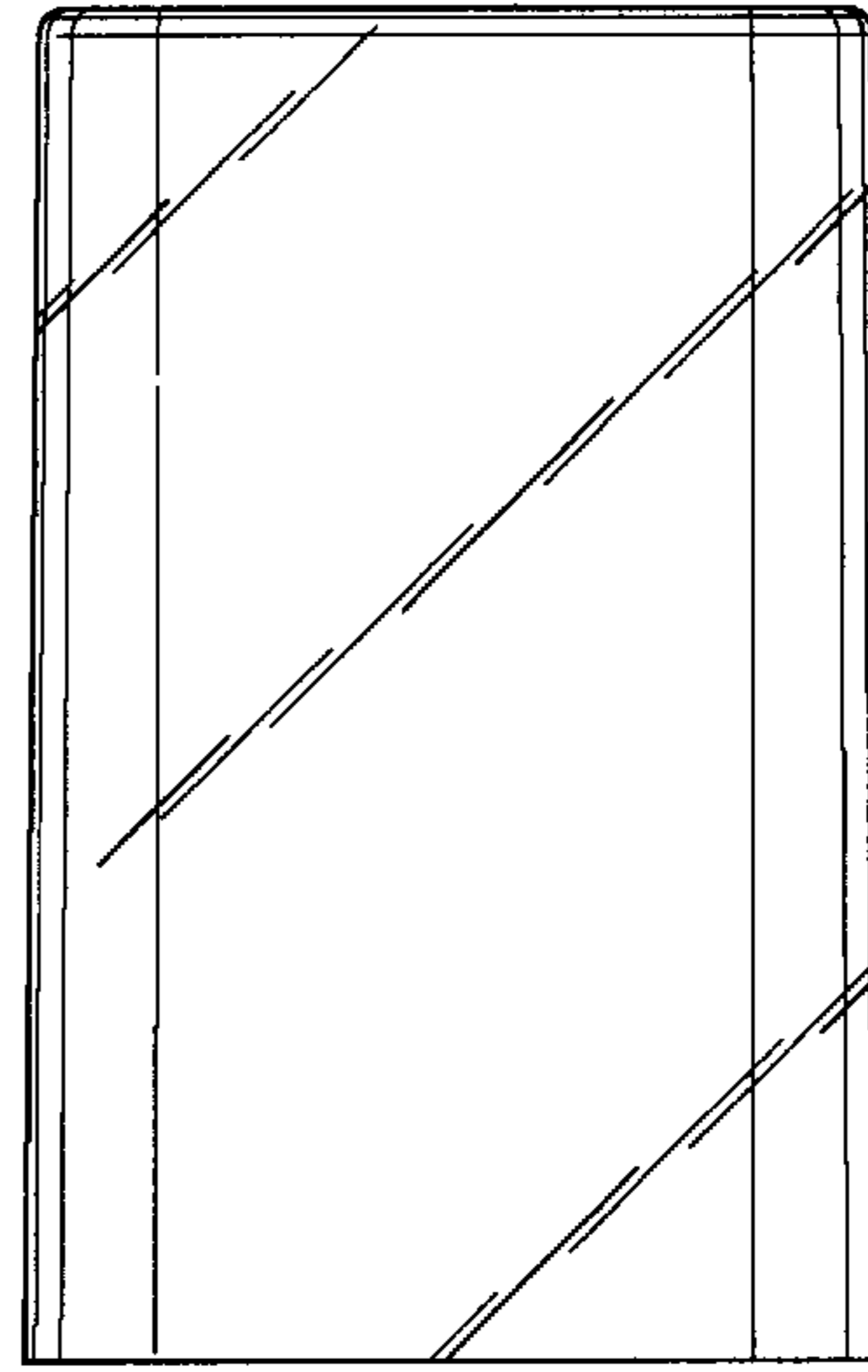
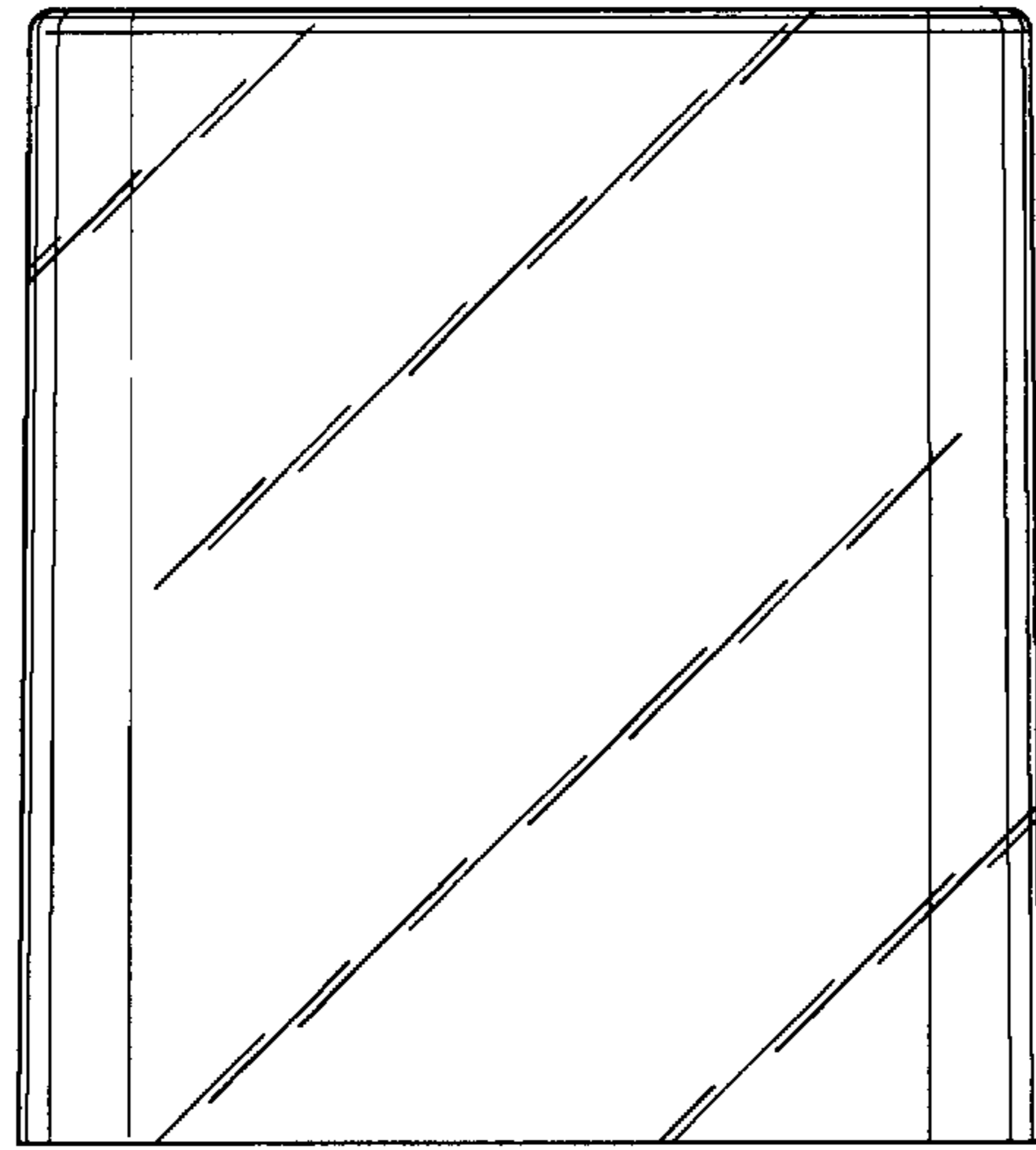

FIG. 9

FIG. 10

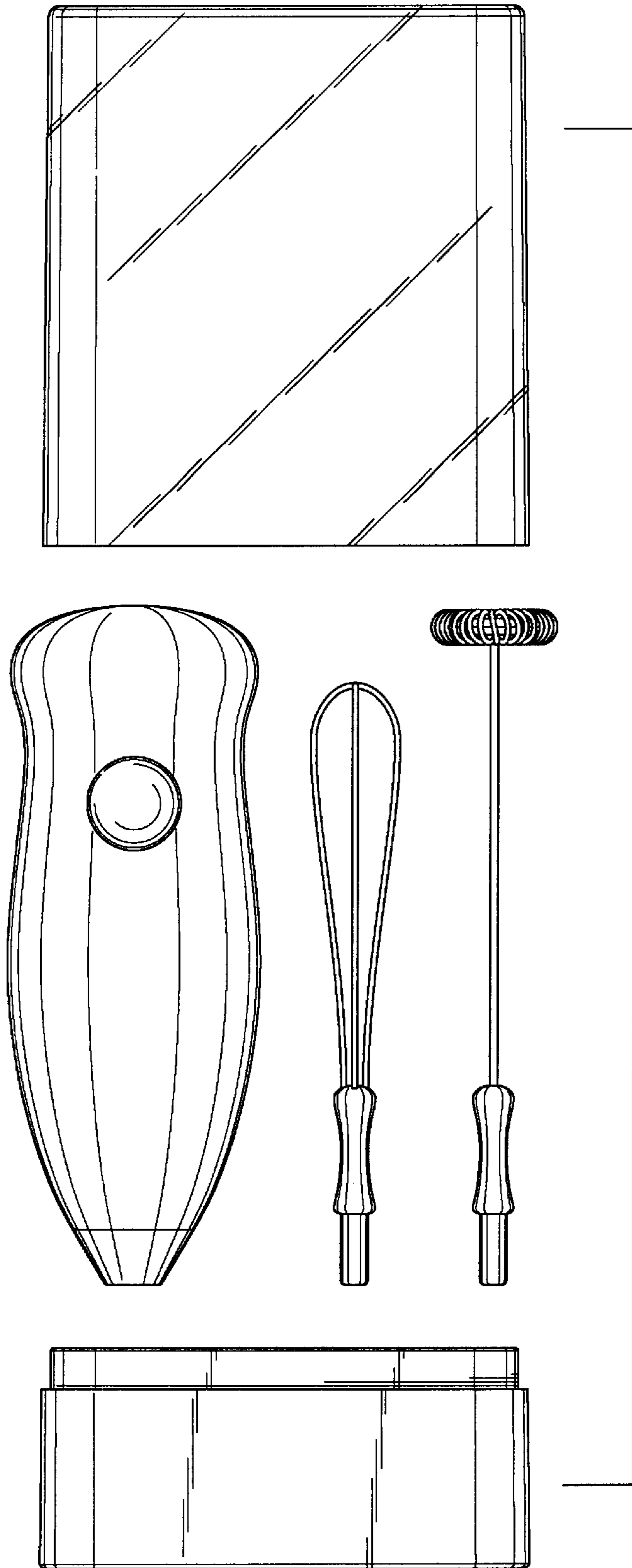

FIG. 11

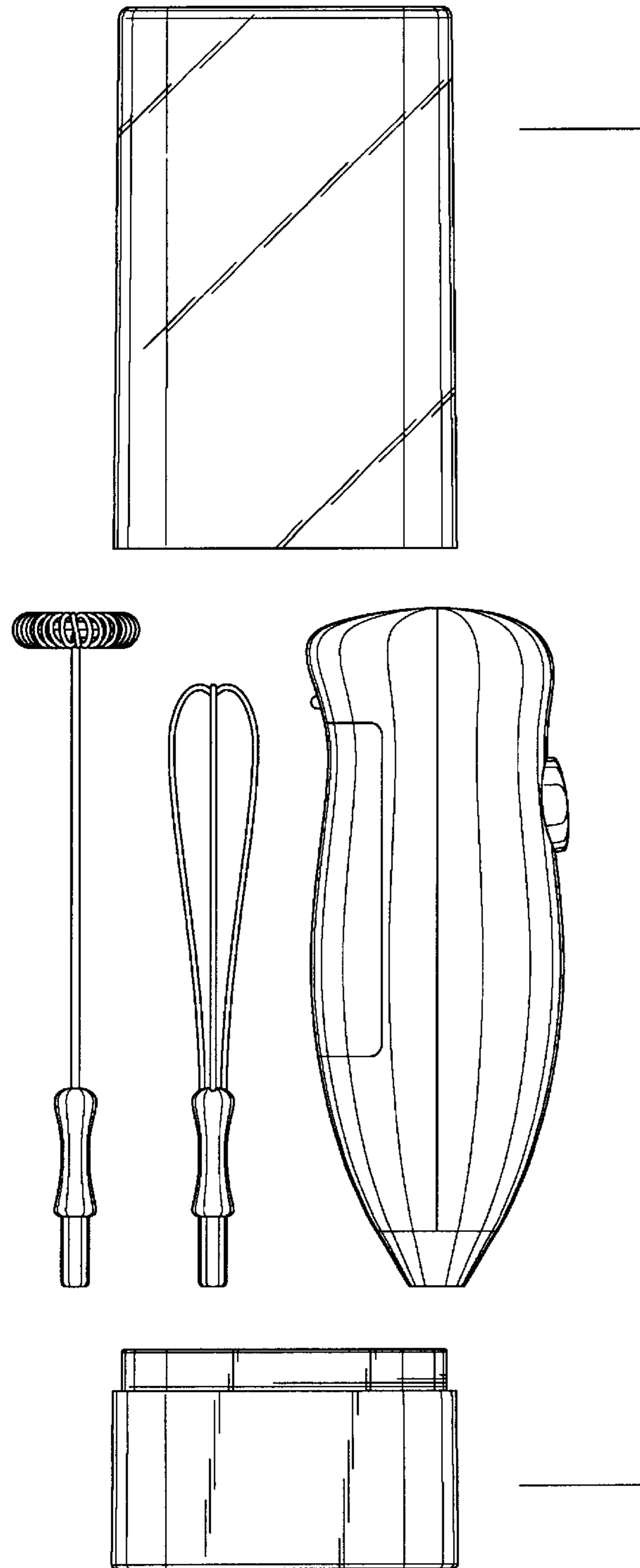

FIG. 12