



US00D536442S

(12) **United States Design Patent**  
**Berg**

(10) **Patent No.:** **US D536,442 S**

(45) **Date of Patent:** **\*\* Feb. 6, 2007**

(54) **PEDIATRIC TRACHEOSTOMY MASK**

D485,905 S \* 1/2004 Moore et al. .... D24/110.1  
7,047,972 B2 \* 5/2006 Ging et al. .... 128/207.11

(76) **Inventor:** **Marsha Berg**, 2231 Birdwood Dr.,  
Orange Park, FL (US) 32073

\* cited by examiner

(\*\*) **Term:** **14 Years**

*Primary Examiner*—Antoine D. Davis

*Assistant Examiner*—Christopher Lee

(21) **Appl. No.:** **29/242,352**

(74) *Attorney, Agent, or Firm*—Thomas C. Saitta

(22) **Filed:** **Nov. 9, 2005**

(57) **CLAIM**

(51) **LOC (8) Cl.** ..... **29-02**

The ornamental design for a pediatric tracheostomy mask, as shown.

(52) **U.S. Cl.** ..... **D24/110.1; D24/110.4**

(58) **Field of Classification Search** ..... D24/110,  
D24/110.1–110.6; 128/207.11, 207.13, 204.12,  
128/206.18, 206.28, 206.24, 206.21, 205.25  
See application file for complete search history.

**DESCRIPTION**

FIG. 1 is a front perspective view of the invention.

FIG. 2 is a front view.

FIG. 3 is a rear view.

FIG. 4 is a left side view.

FIG. 5 is a right side view.

FIG. 6 is a top view; and,

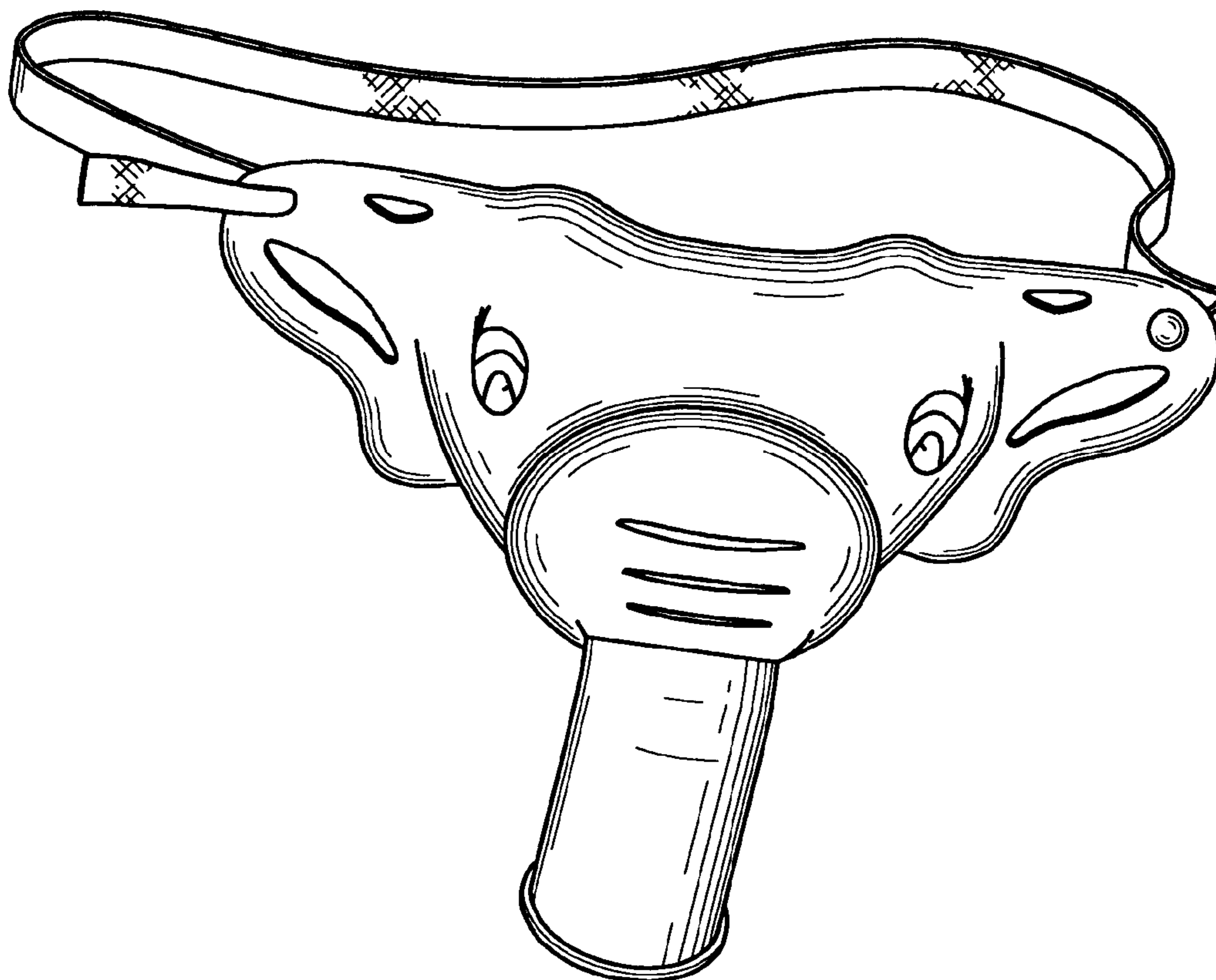
FIG. 7 is a bottom view.

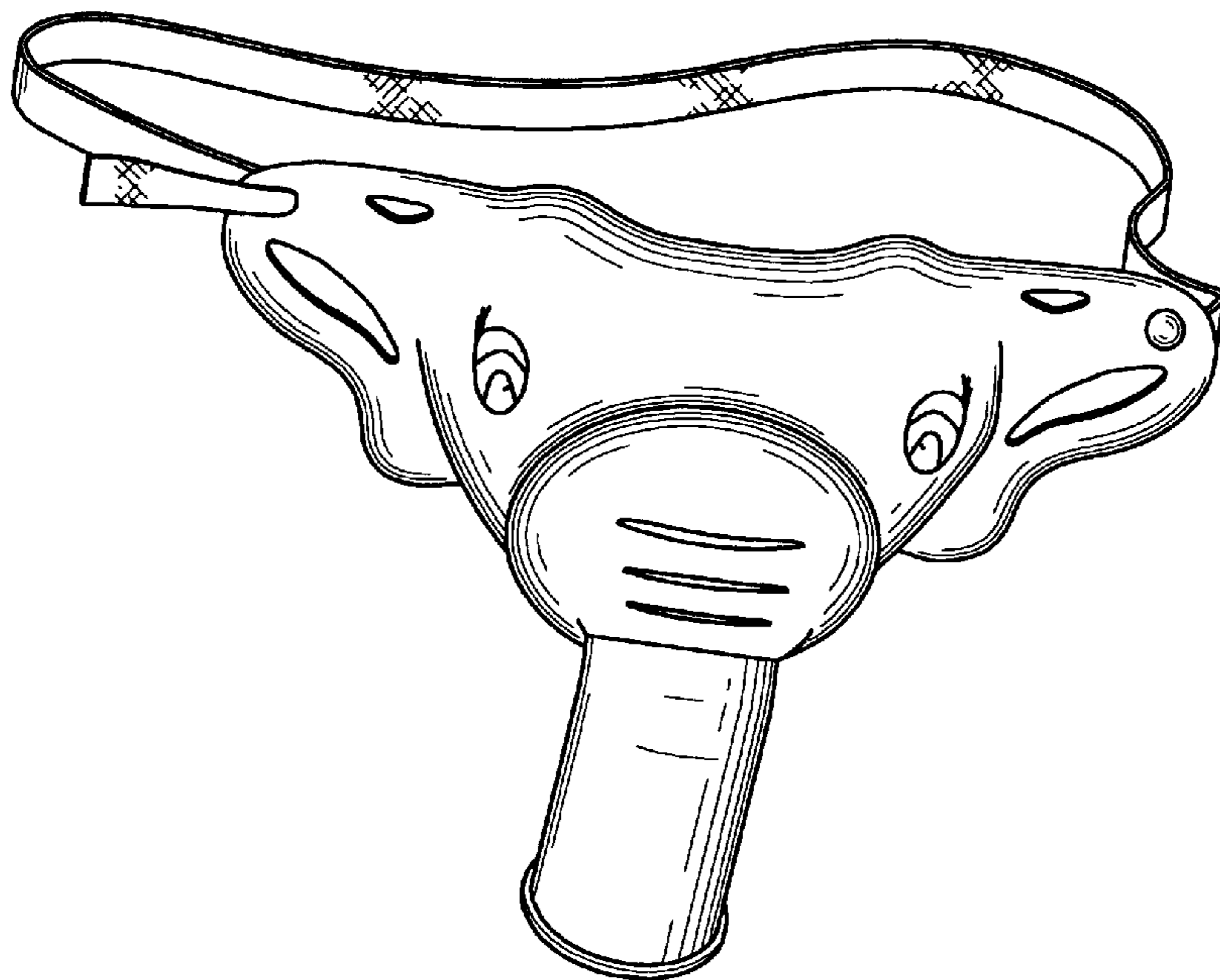
(56) **References Cited**

**U.S. PATENT DOCUMENTS**

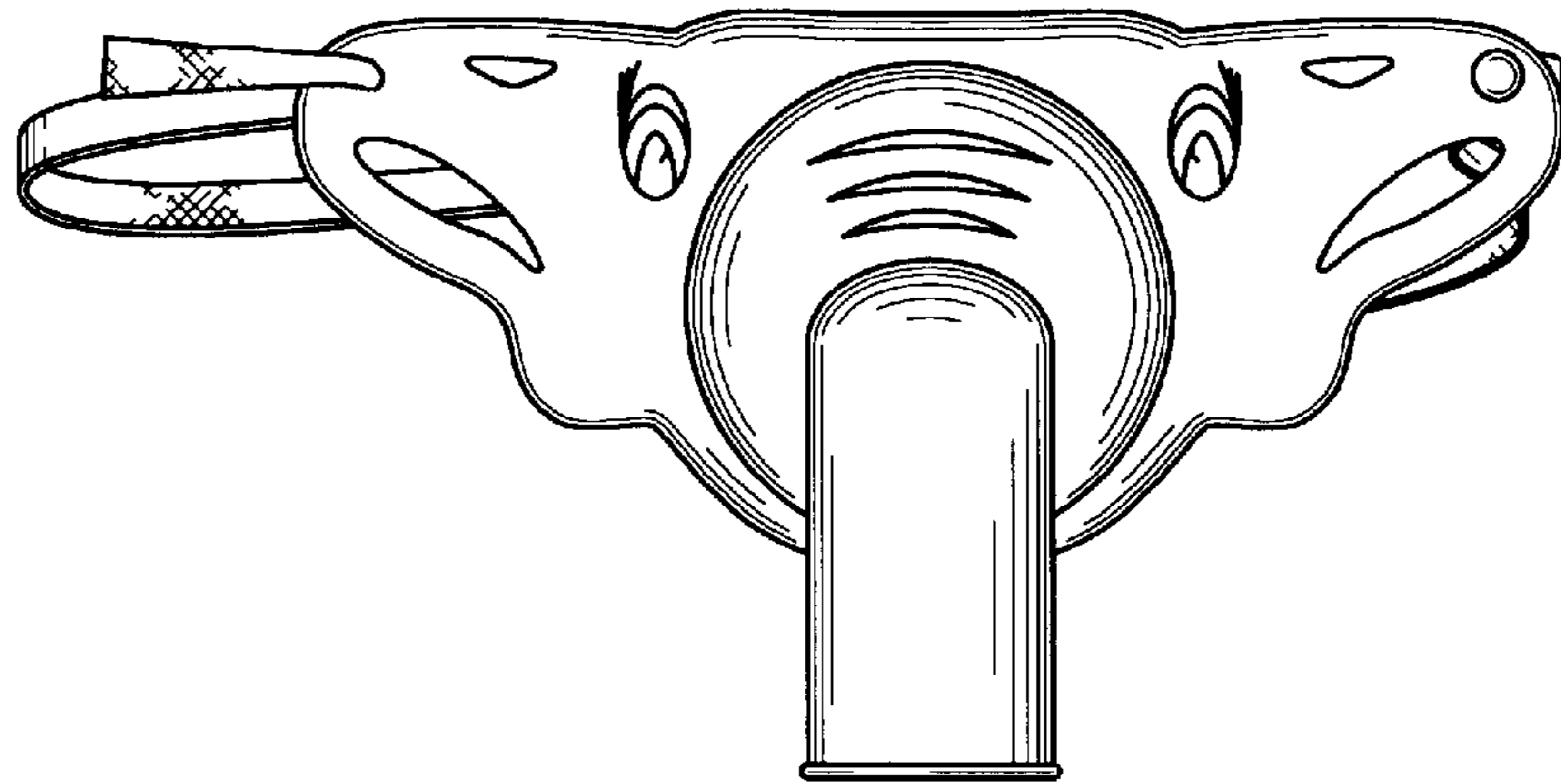
D333,015 S \* 2/1993 Farmer et al. .... D24/110.4  
D385,960 S \* 11/1997 Rudolph ..... D24/110.4  
5,724,965 A \* 3/1998 Handke et al. .... 128/207.13

**1 Claim, 4 Drawing Sheets**

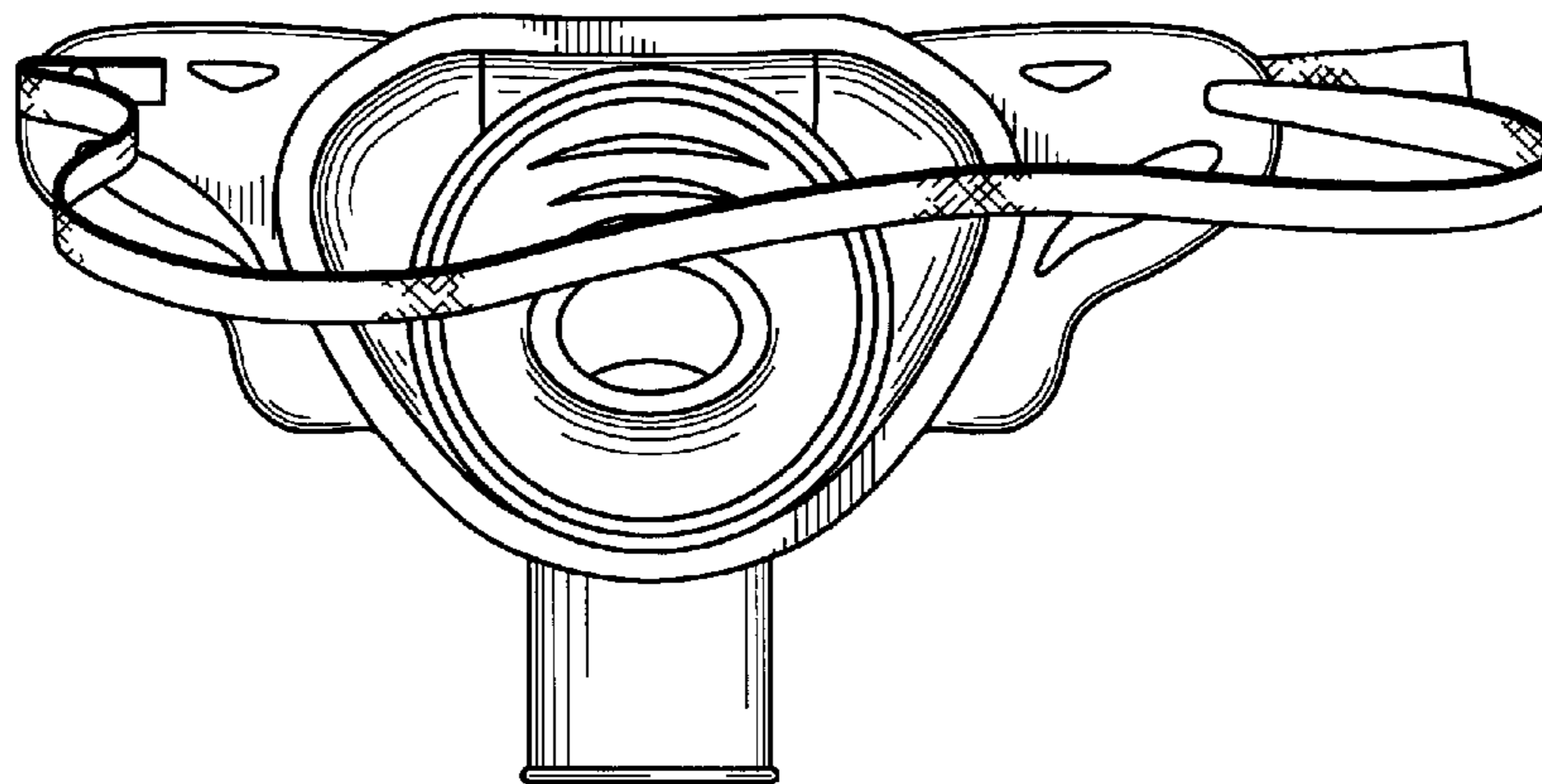




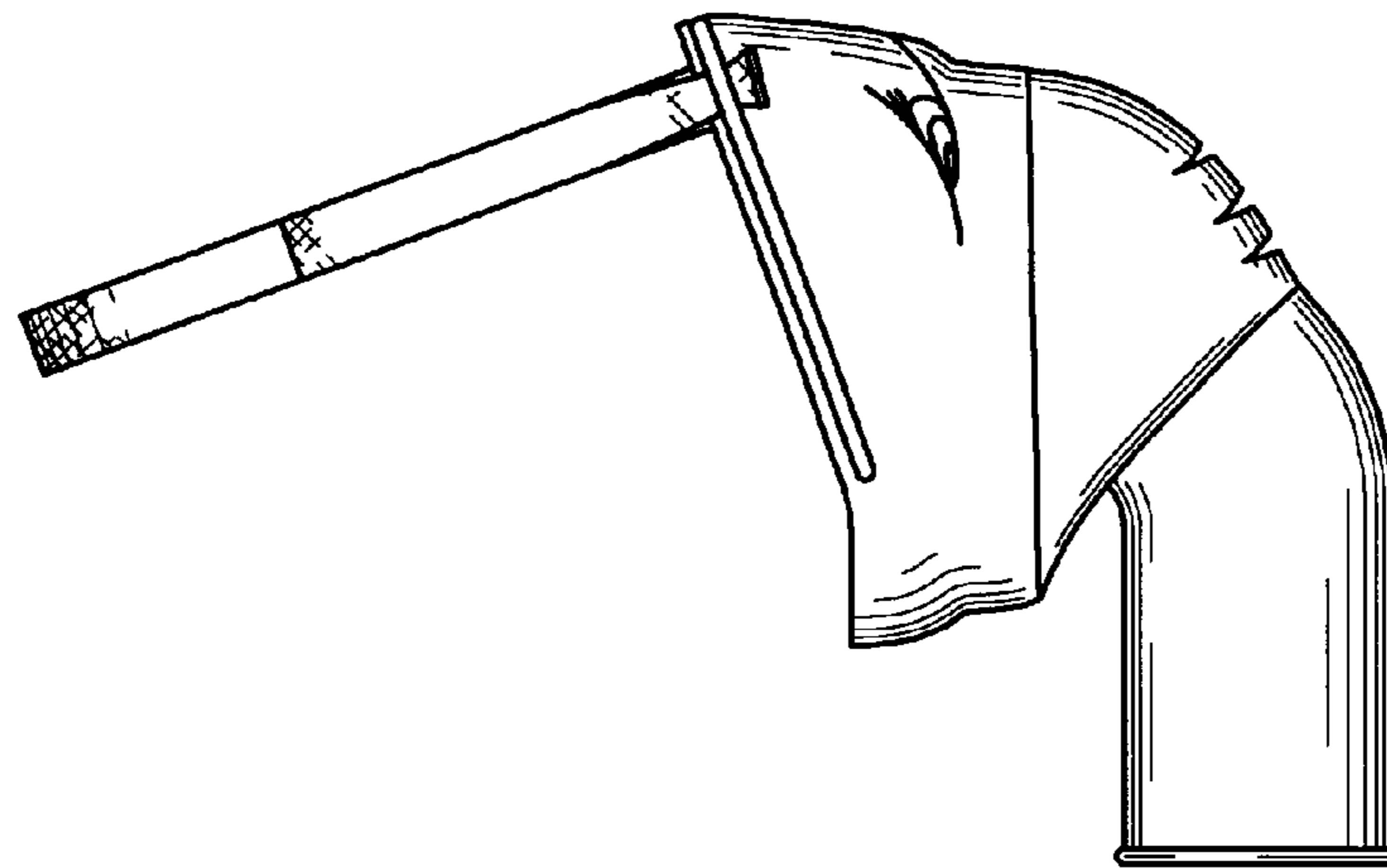
*Fig. 1*



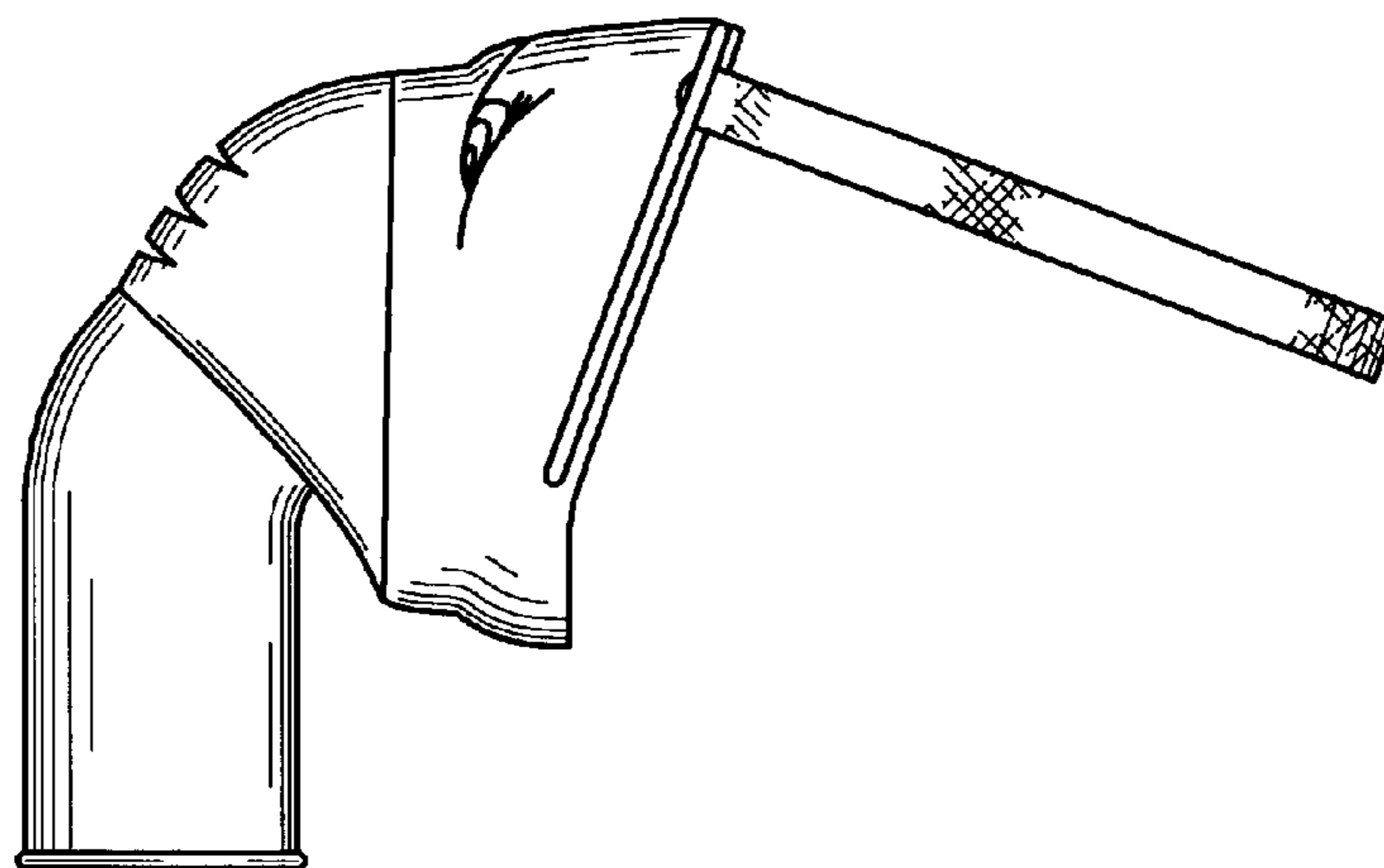
*Fig. 2*



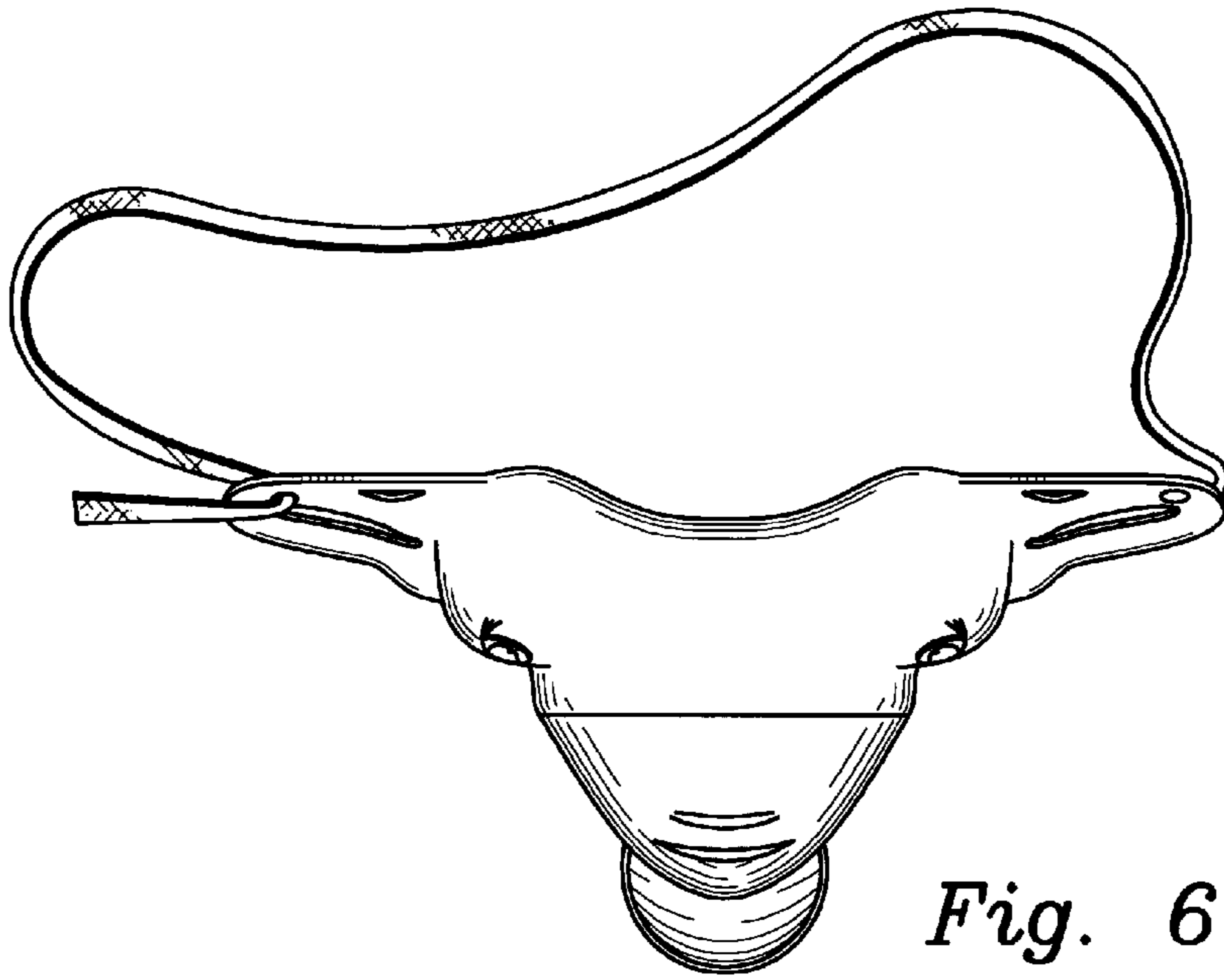
*Fig. 3*



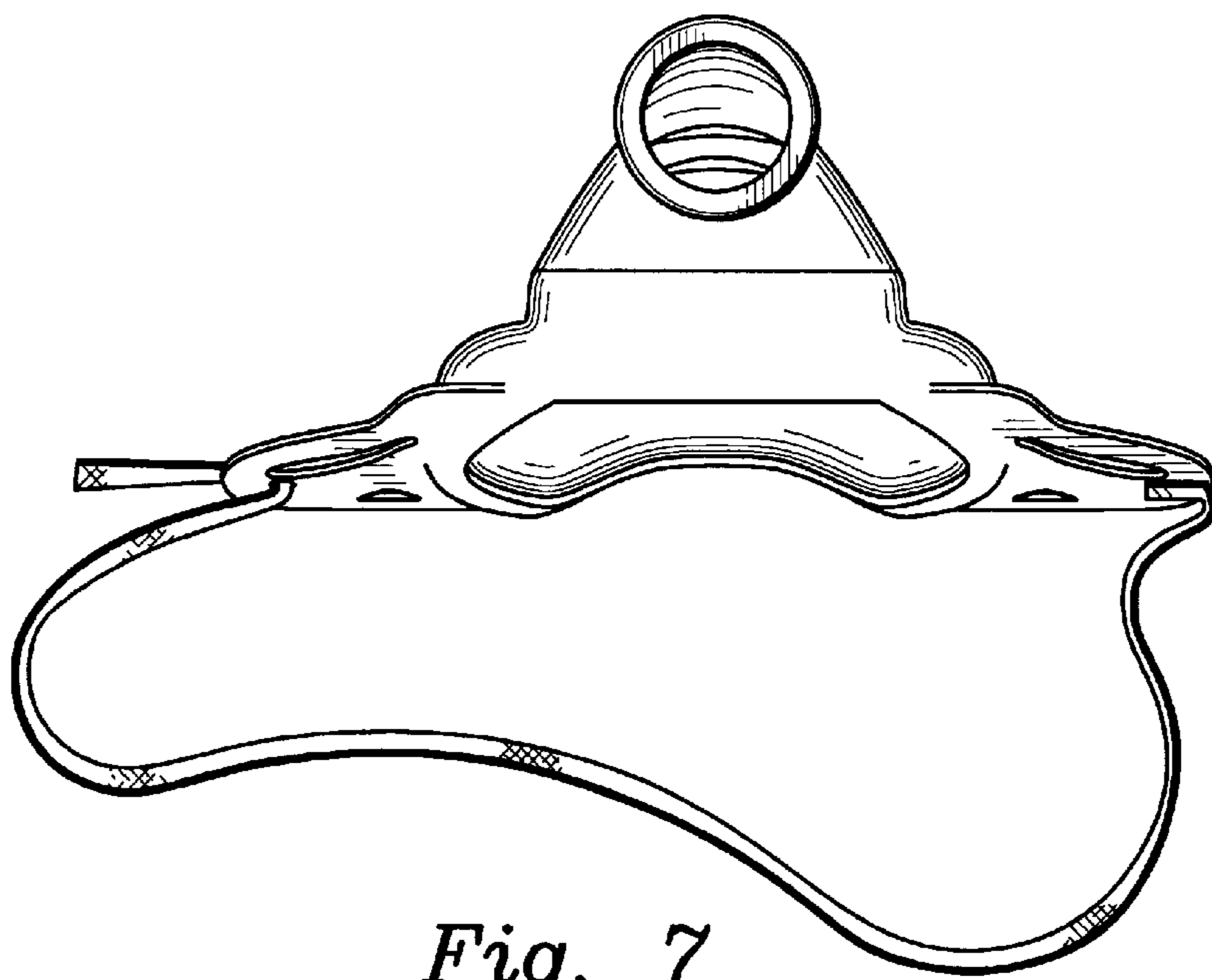
*Fig. 4*



*Fig. 5*



*Fig. 6*



*Fig. 7*