



US00D536428S

(12) **United States Design Patent** (10) **Patent No.:** **US D536,428 S**
Kohler, Jr. et al. (45) **Date of Patent:** **** Feb. 6, 2007**

(54) **PLUMBING FIXTURE**

OTHER PUBLICATIONS

(75) Inventors: **Herbert V. Kohler, Jr.**, Kohler, WI
(US); **Francois Kergoet**, Malakoff (FR)

Jacob Delafon catalog, p. 31, Altair toilet.

* cited by examiner

(73) Assignee: **Kohler Co.**, Kohler, WI (US)

Primary Examiner—Robert A. Delehanty

(**) Term: **14 Years**

(74) *Attorney, Agent, or Firm*—Quarles & Brady LLP

(21) Appl. No.: **29/240,082**

(57) **CLAIM**

(22) Filed: **Oct. 7, 2005**

The ornamental design for a plumbing fixture, as shown and described.

(51) **LOC (8) Cl.** **23-02**

DESCRIPTION

(52) **U.S. Cl.** **D23/295**

(58) **Field of Classification Search** D23/273–274,
D23/295–301, 303, 309, 313; 4/663–665,
4/300–300.3, 312–313, 328–329, 353, 420,
4/443–446, 449, 459–460, 479–480, 902,
4/905, DIG. 11, DIG. 12, DIG. 15
See application file for complete search history.

In a preferred embodiment, the nature of this product is as a plumbing fixture in the form of a water closet and a base for a water closet.

FIG. 1 is a right, top, front perspective view of a plumbing fixture embodying our new design;

FIG. 2 is a top plan view thereof;

FIG. 3 is a front elevational view thereof;

FIG. 4 is a right side elevational view thereof, the left side elevational view thereof being a mirror image of the right side shown;

FIG. 5 is a rear elevational view thereof; and,

FIG. 6 is a bottom plan view thereof.

The broken line representations of a bowl opening internal structure and holes in FIGS. 1 and 2, side wall structure in FIG. 1, rear structure in FIG. 5, and underside structure in FIG. 6, are for the purpose of illustration only, and form no part of the claimed design.

(56) **References Cited**

U.S. PATENT DOCUMENTS

D268,779 S	4/1983	Doman	
D311,057 S	10/1990	Stairs, Jr.	
D346,854 S	* 5/1994	Reid D23/301
D349,156 S	* 7/1994	Kohler et al. D23/301
D379,217 S	5/1997	Kergoet	
D439,638 S	* 3/2001	Hundley D23/295
D439,639 S	* 3/2001	Cardwell et al. D23/295
D483,447 S	12/2003	Ruxchaivan	
D483,448 S	12/2003	Ruxchaivan	
D492,016 S	6/2004	Schmidt	

1 Claim, 3 Drawing Sheets

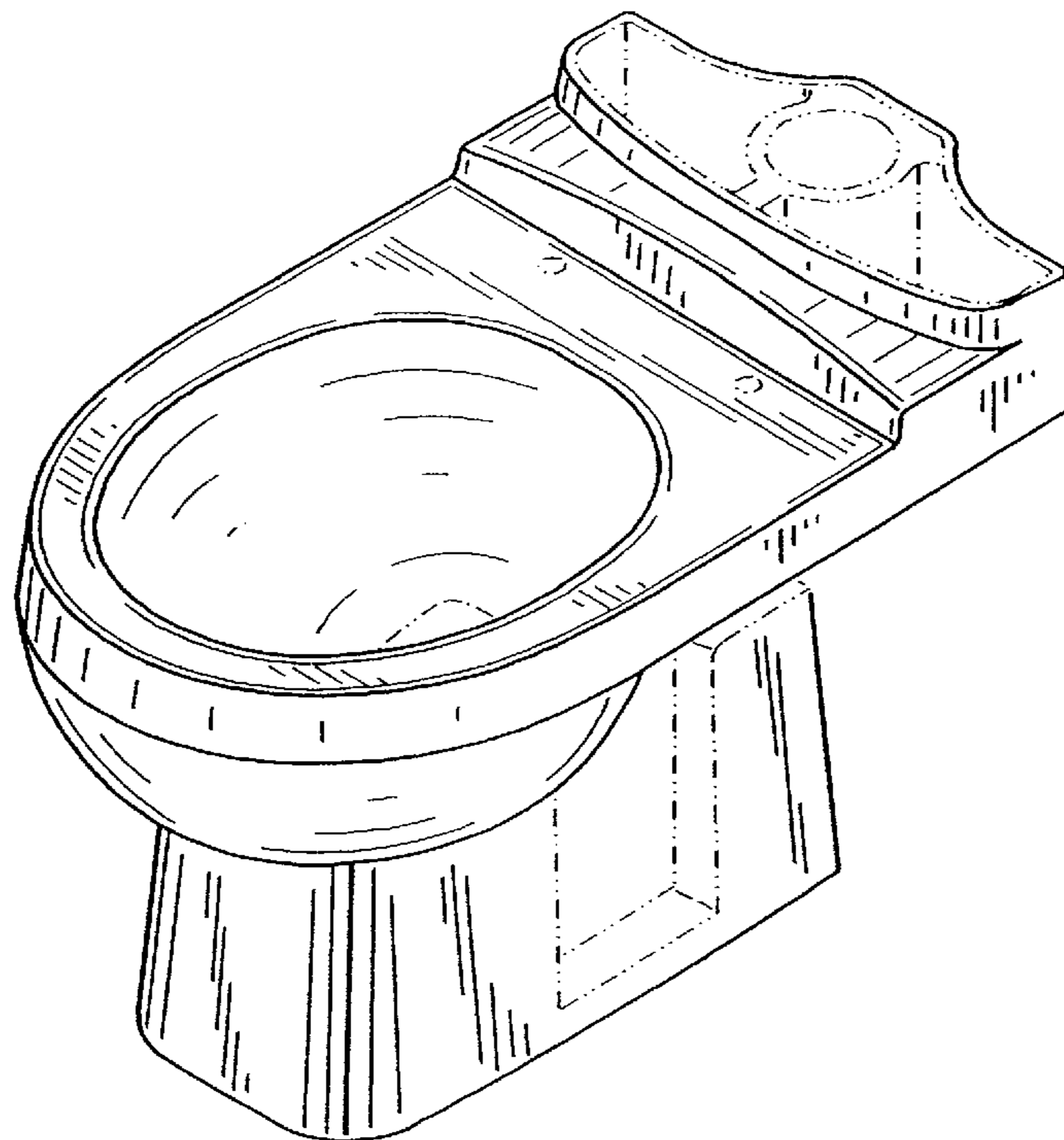

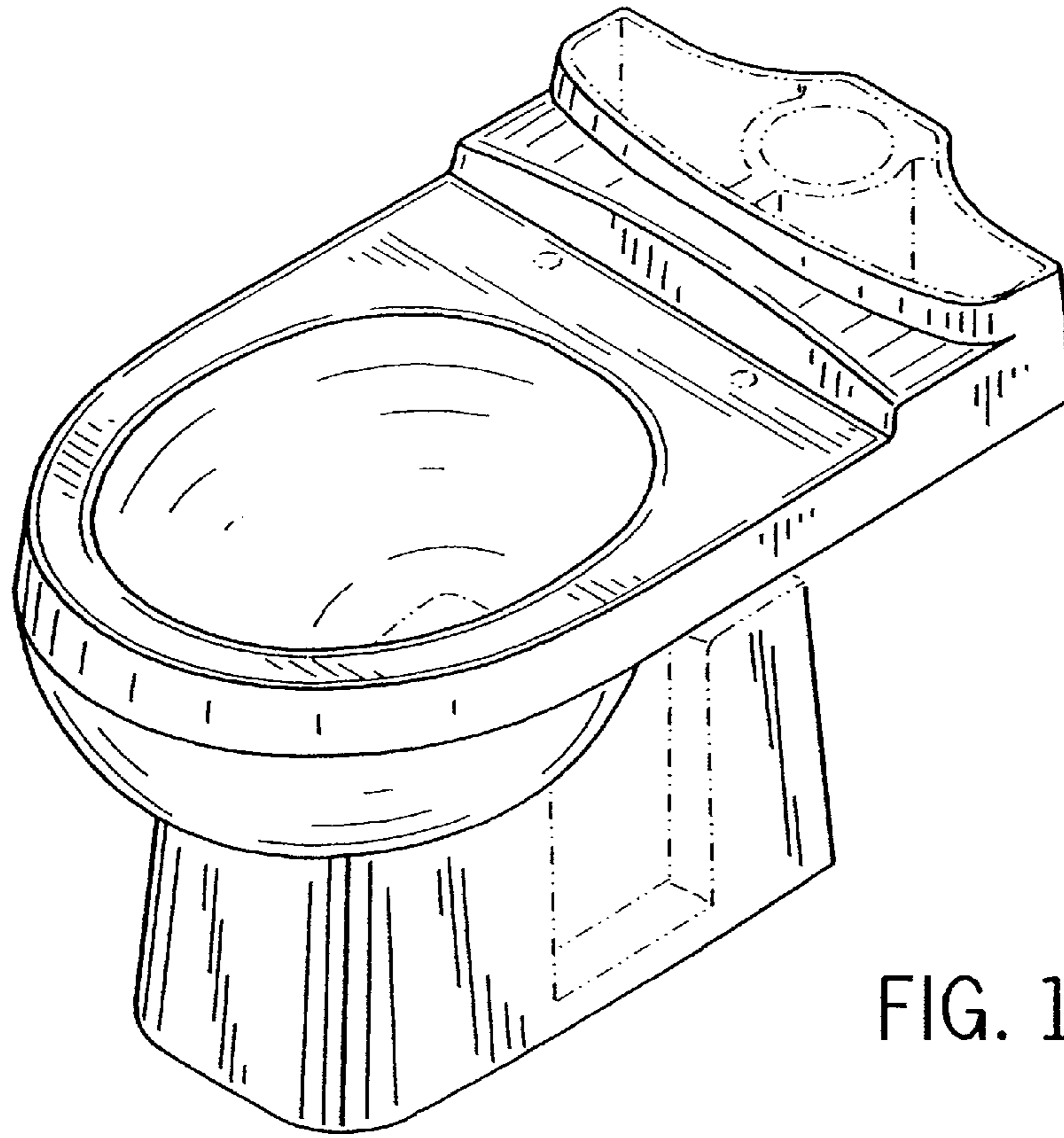

FIG. 1

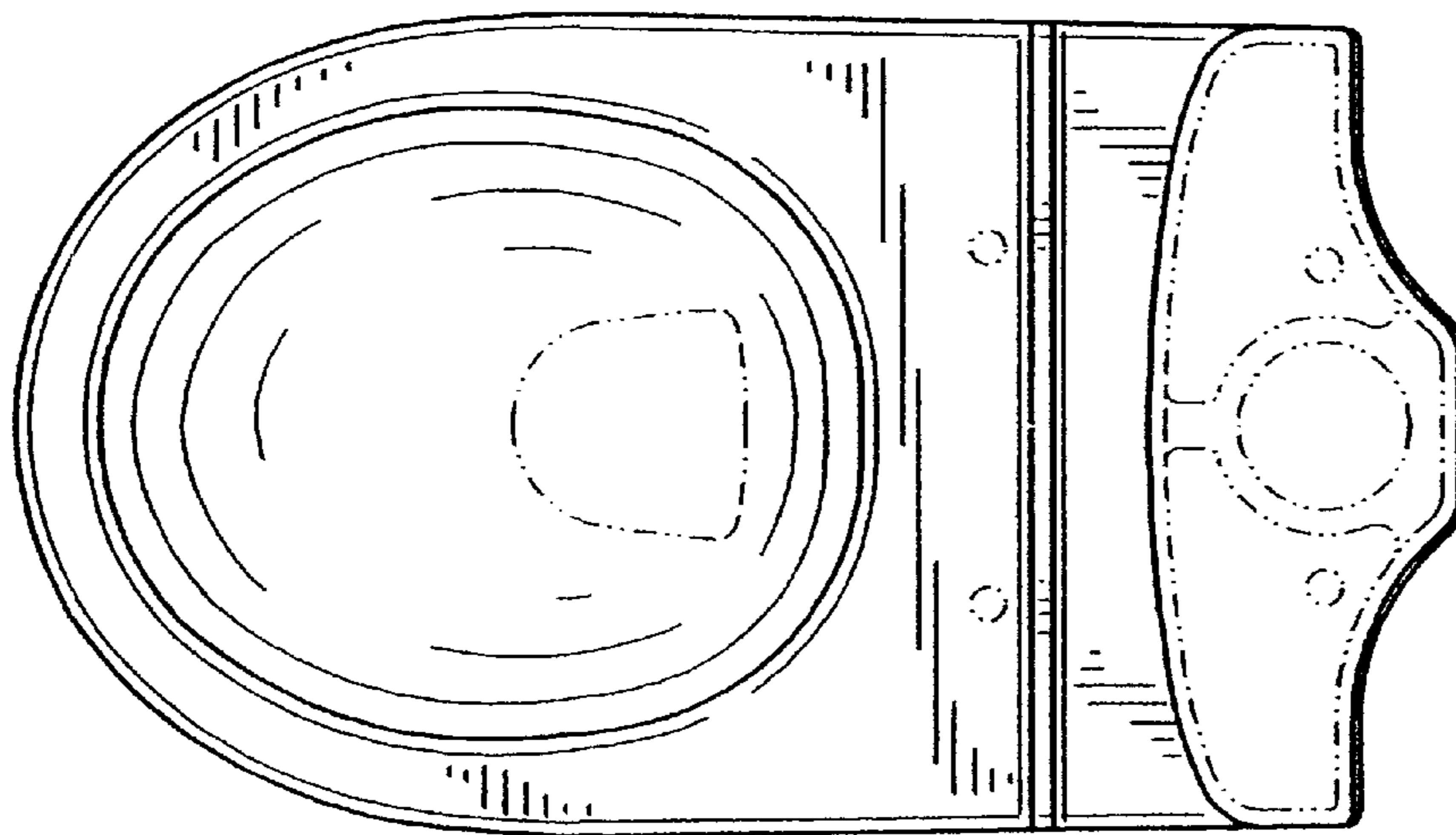

FIG. 2

FIG. 3

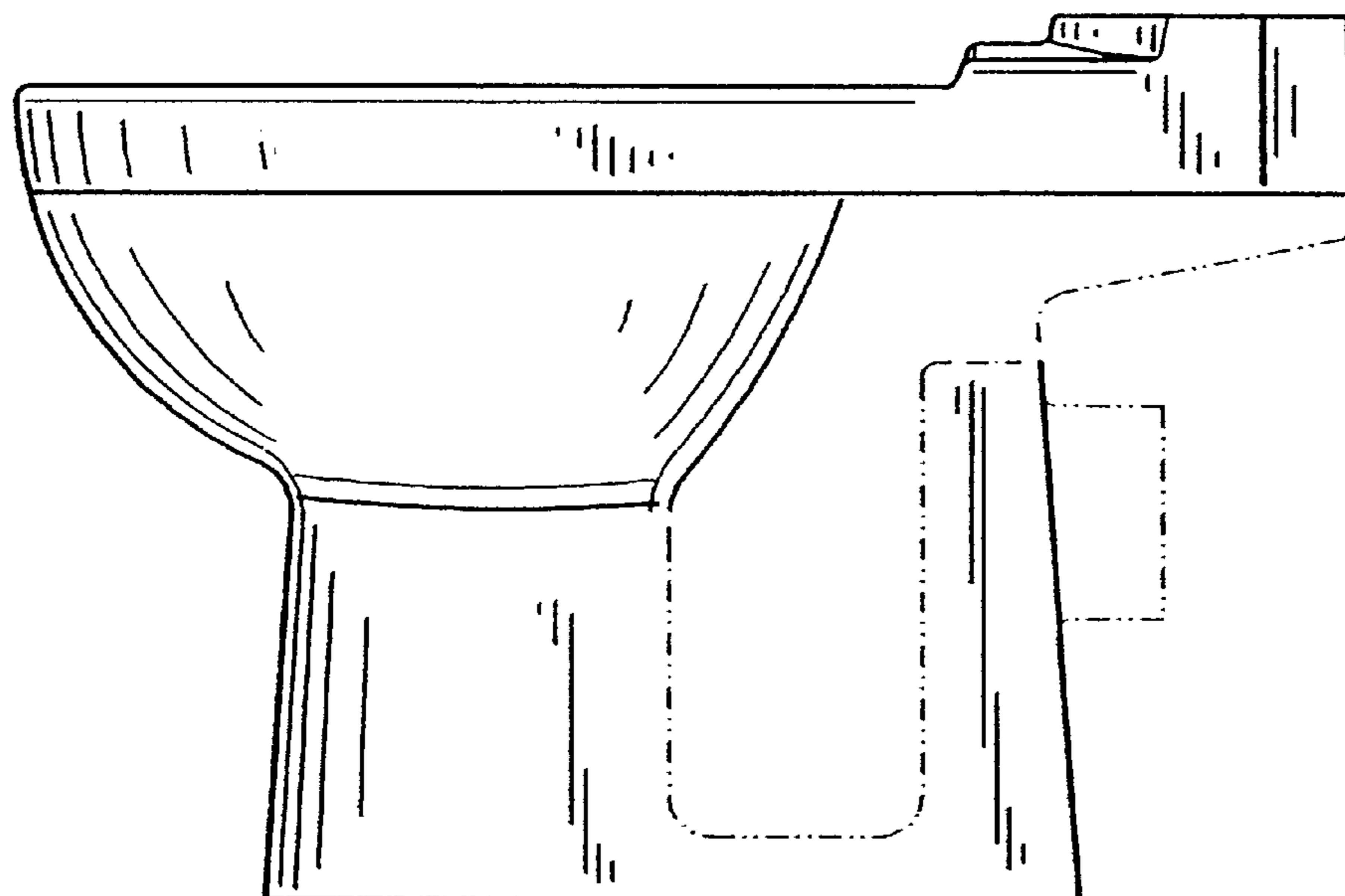
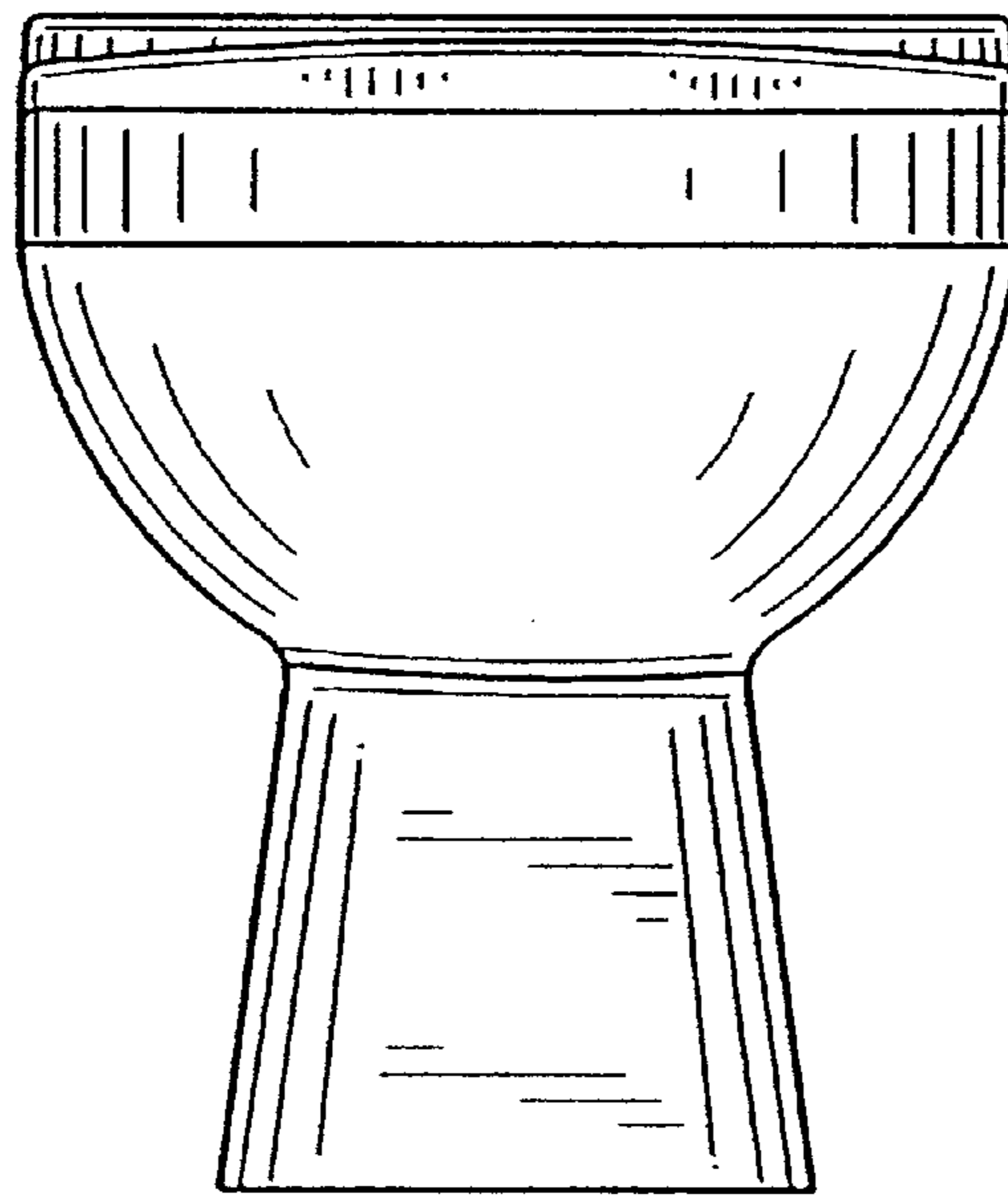

FIG. 4

FIG. 5

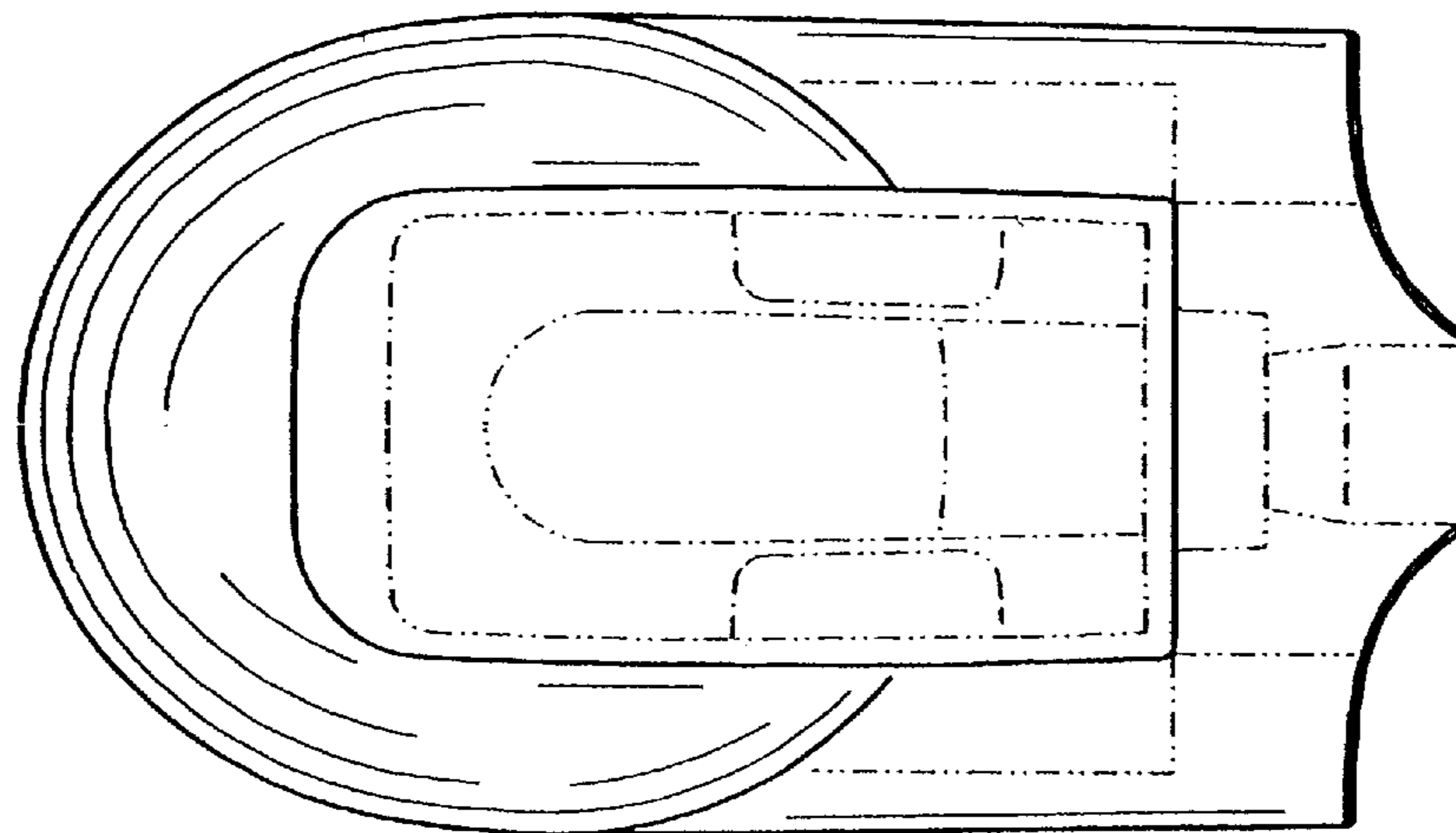
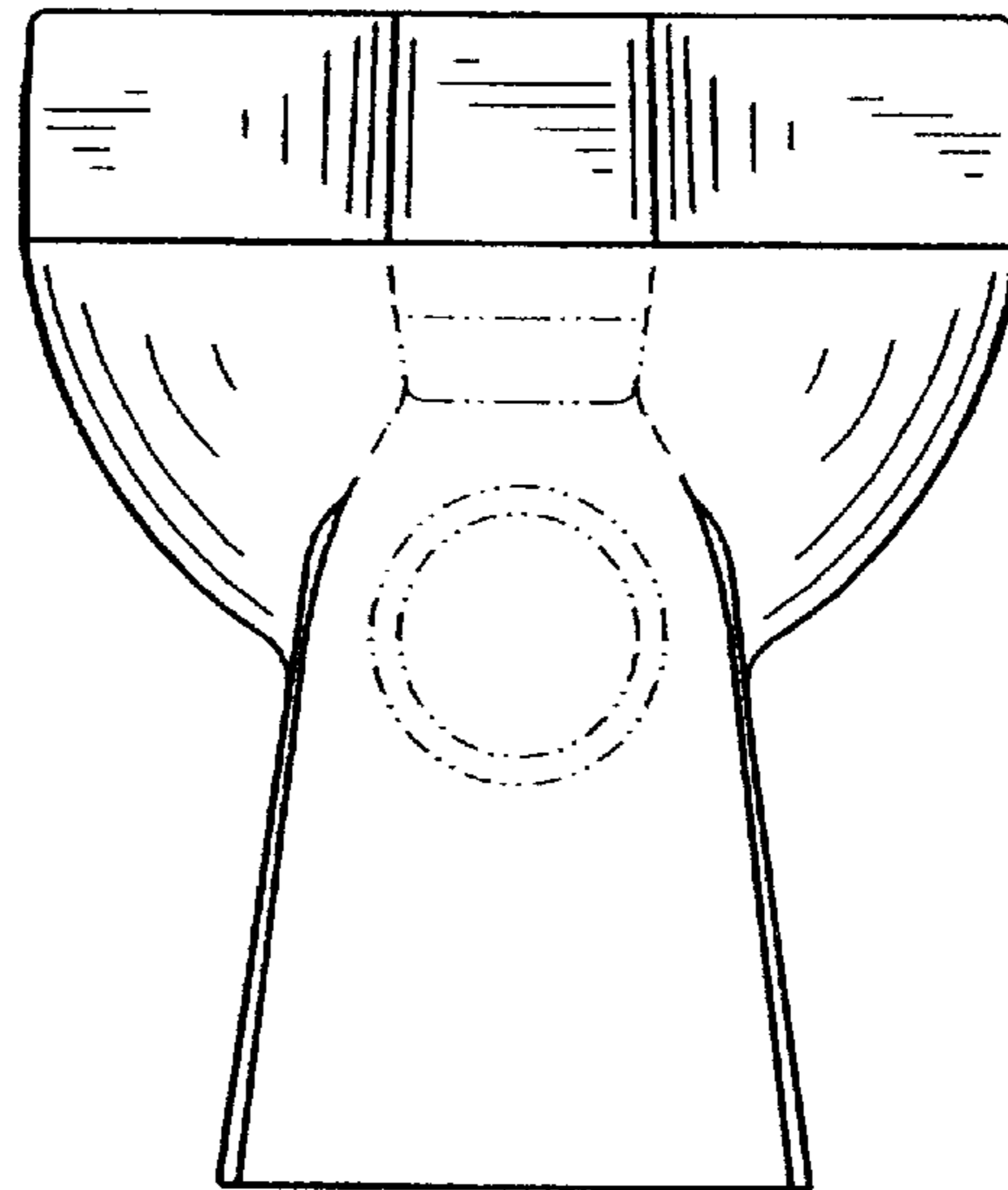

FIG. 6