



US00D536376S

(12) **United States Design Patent**
Wehmeyer

(10) **Patent No.:** **US D536,376 S**
(45) **Date of Patent:** **** Feb. 6, 2007**

(54) **BINDER**

(75) Inventor: **Stephen D. Wehmeyer**, Cincinnati, OH (US)

(73) Assignee: **MeadWestvaco Corporation**, Glen Allen, VA (US)

(**) Term: **14 Years**

(21) Appl. No.: **29/226,206**

(22) Filed: **Mar. 25, 2005**

Related U.S. Application Data

(63) Continuation-in-part of application No. 10/962,724, filed on Oct. 12, 2004, which is a continuation-in-part of application No. 10/828,073, filed on Apr. 20, 2004.

(51) **LOC (8) Cl.** **19-04**

(52) **U.S. Cl.** **D19/27**

(58) **Field of Classification Search** D19/26-33;
281/15.1, 19.1, 21.1, 22, 28, 29, 38, 50, 51,
281/27.1, 27.2, 27.3; 283/63.1, 64; 402/73,
402/74, 75

See application file for complete search history.

(56) **References Cited**

U.S. PATENT DOCUMENTS

2,333,523 A * 11/1943 Cohun 281/16
3,025,834 A 3/1962 Aaron

(Continued)

Primary Examiner—Elizabeth A. Albert

(74) *Attorney, Agent, or Firm*—Thompson Hine LLP

(57) **CLAIM**

The ornamental design for a binder, as shown and described.

DESCRIPTION

FIG. 1 is a front perspective view of a binder in a first configuration showing my new design;

FIG. 2 is a front perspective view of the binder of FIG. 1 in a second configuration;

FIG. 3 is a front view of the binder of FIG. 2;

FIG. 4 is a rear view of the binder of FIG. 2;

FIG. 5 is a first end view of the binder of FIG. 2;

FIG. 6 is a second end view of the binder of FIG. 2;

FIG. 7 is a first side view of the binder of FIG. 2;

FIG. 8 is a second side view of the binder of FIG. 2;

FIG. 9 is a front perspective view of a second embodiment of the present invention in a first configuration;

FIG. 10 is a front perspective view of the binder of FIG. 9 in a second configuration;

FIG. 11 is a front view of the binder of FIG. 10;

FIG. 12 is a rear view of the binder of FIG. 10;

FIG. 13 is a first end view of the binder of FIG. 10;

FIG. 14 is a second end view of the binder of FIG. 10;

FIG. 15 is a first side view of the binder of FIG. 10;

FIG. 16 is a second side view of the binder of FIG. 10;

FIG. 17 is a front perspective view of a third embodiment of the present invention;

FIG. 18 is a rear perspective view of the binder of FIG. 17;

FIG. 19 is a front view of the binder of FIG. 17;

FIG. 20 is a rear view of the binder of FIG. 17;

FIG. 21 is a first side view of the binder of FIG. 17;

FIG. 22 is a second side view of the binder of FIG. 17;

FIG. 23 is a first end view of the binder of FIG. 17;

FIG. 24 is a second end view of the binder of FIG. 17;

FIG. 25 is a front perspective view of a fourth embodiment of the present invention;

FIG. 26 is a rear perspective view of the binder of FIG. 25;

FIG. 27 is a front view of the binder of FIG. 25;

FIG. 28 is a rear view of the binder of FIG. 25;

FIG. 29 is a first side view of the binder of FIG. 25;

FIG. 30 is a second side view of the binder of FIG. 25;

FIG. 31 is a first end view of the binder of FIG. 25; and,

FIG. 32 is a second end view of the binder of FIG. 25.

The broken lines are for illustrative purposes only and do not constitute any part of the claimed design.

1 Claim, 24 Drawing Sheets

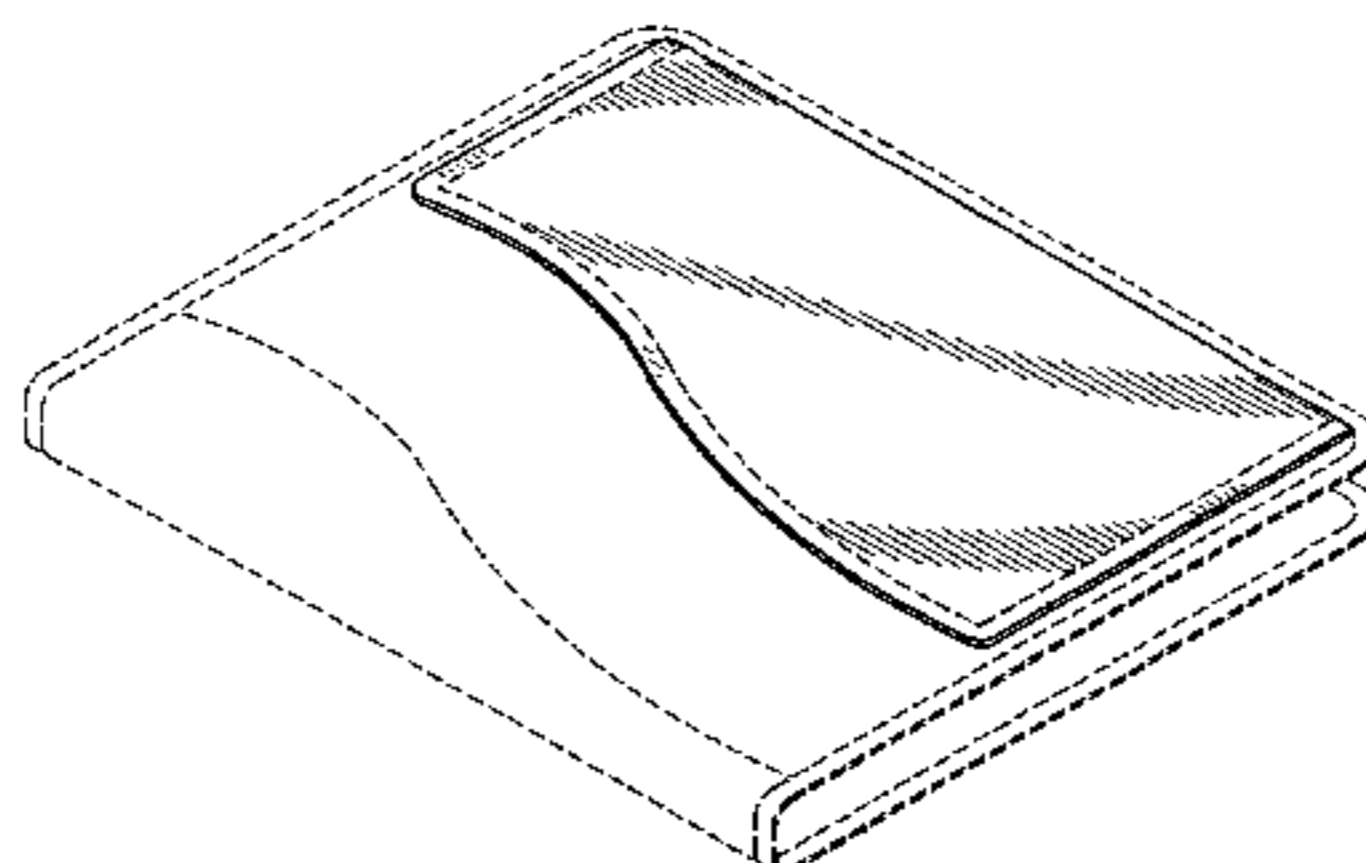
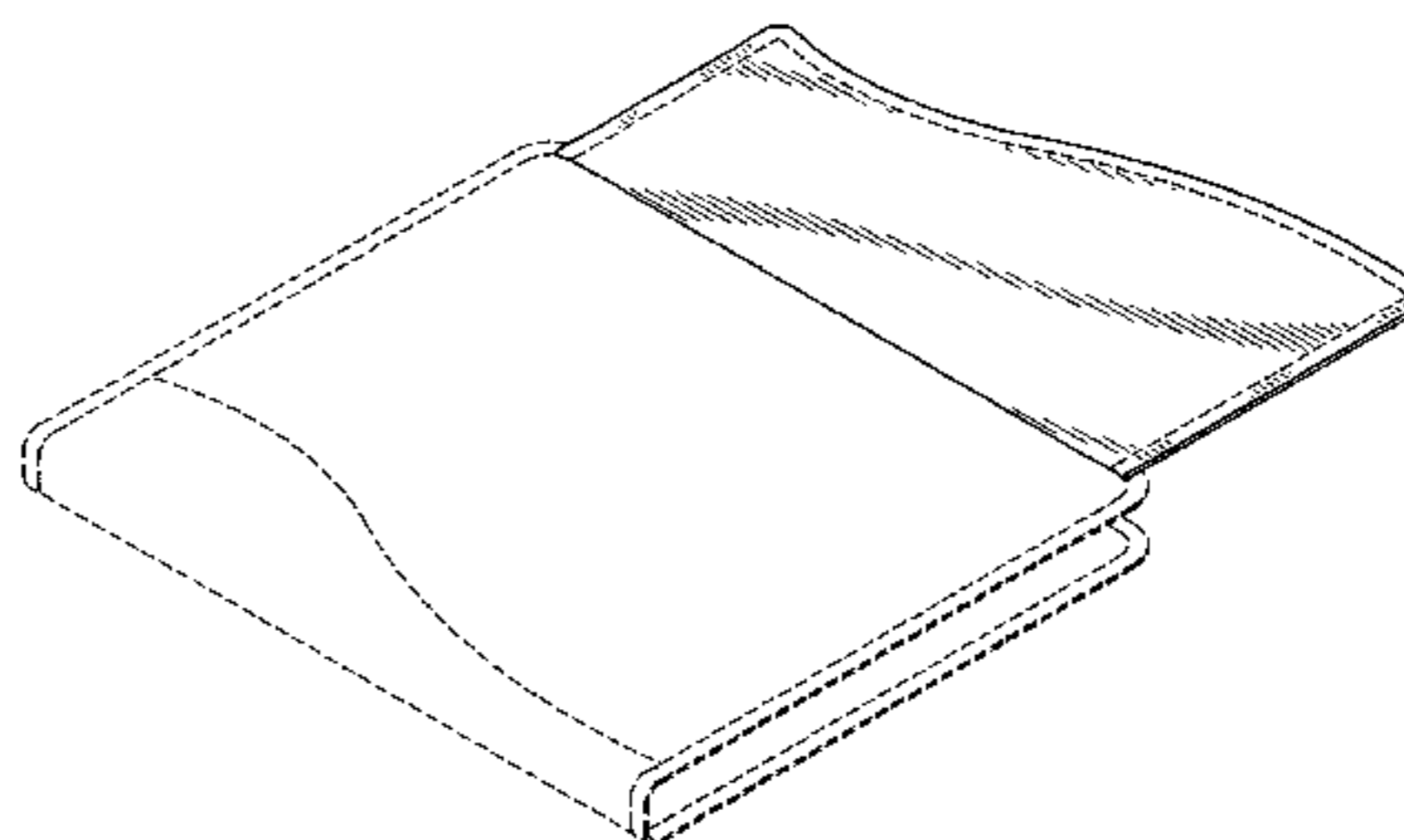

US D536,376 S

Page 2

U.S. PATENT DOCUMENTS					
			5,855,442 A	1/1999	Keller
			5,895,160 A	4/1999	Ginelli
3,077,184 A	2/1963	Vogel	5,957,700 A	9/1999	Ariyama
3,528,602 A *	9/1970	Ritchie 229/67.1	6,004,057 A	12/1999	Fulop
D220,296 S	3/1971	Berlin	6,019,535 A	2/2000	Turner
3,684,389 A	8/1972	Eron et al.	6,031,023 A	2/2000	Carroll et al.
3,941,488 A	3/1976	Maxwell	6,048,121 A	4/2000	Carver
3,985,455 A	10/1976	Wahlberg	6,179,501 B1	1/2001	Fulop
4,221,490 A	9/1980	Malm	D440,253 S *	4/2001	Wolff et al. D19/86
4,357,431 A	11/1982	Murakami et al.	6,250,006 B1	6/2001	Berrier
4,509,875 A	4/1985	Shintani	D445,130 S	7/2001	Ginelli
D279,992 S	8/1985	Gribb	D451,139 S	11/2001	Wang
4,549,827 A	10/1985	Mack	6,344,498 B1	2/2002	Allison et al.
4,557,618 A	12/1985	Iwata et al.	6,379,001 B1	4/2002	Tomida et al.
4,600,327 A	7/1986	Guzman	6,435,747 B1	8/2002	Furukawa et al.
D295,878 S	5/1988	Lovell	6,491,464 B1	12/2002	Young
D303,683 S	9/1989	Brock	6,505,984 B1	1/2003	Smith et al.
D306,316 S	2/1990	Shintani	D471,586 S	3/2003	Geiselhart et al.
D306,873 S	3/1990	Yazaki	6,565,275 B1	5/2003	Brand et al.
D307,602 S	5/1990	Lee	6,607,216 B1	8/2003	Stenger et al.
5,033,895 A	7/1991	Aida	D481,074 S *	10/2003	Shapiro et al. D19/90
5,072,483 A	12/1991	Durand	D489,255 S *	5/2004	Kratzert et al. D9/433
D323,937 S *	2/1992	Solomon D3/299	6,769,829 B1	8/2004	Castillo et al.
5,131,776 A	7/1992	Mott	D499,761 S *	12/2004	Walley et al. D19/26
D336,425 S	6/1993	Napora, Jr.	D509,541 S *	9/2005	Kim D19/99
5,338,123 A	8/1994	Obersteller et al.	2003/0155761 A1	8/2003	Stenger et al.
5,432,973 A	7/1995	Wagner et al.	2003/0157472 A1	8/2003	Castillo et al.
5,489,331 A	2/1996	Miller et al.	2004/0253046 A1 *	12/2004	Africa et al. 402/73
5,492,558 A	2/1996	Miller et al.			
D404,069 S	1/1999	Hasegawa			

* cited by examiner

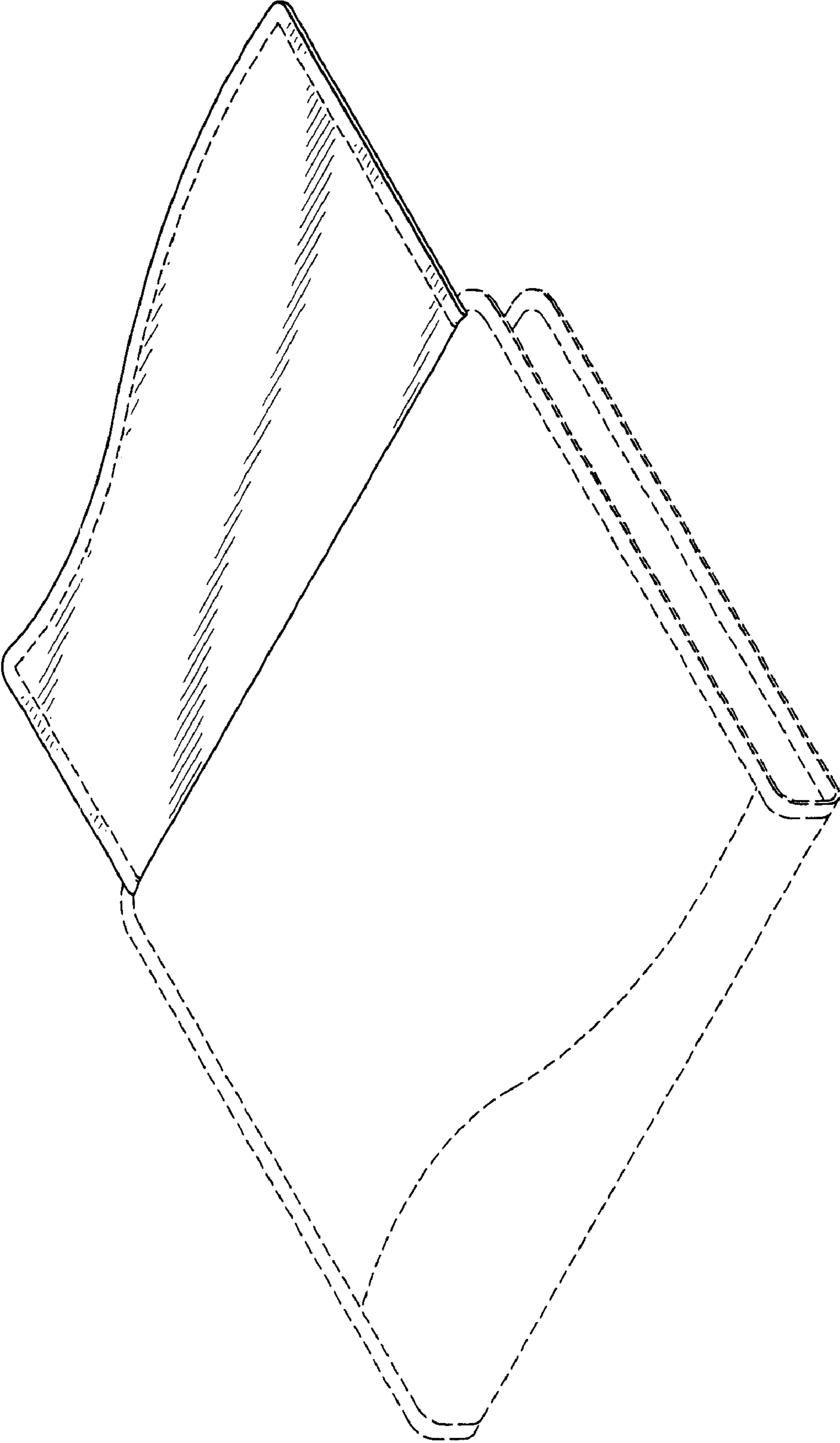

FIG.1

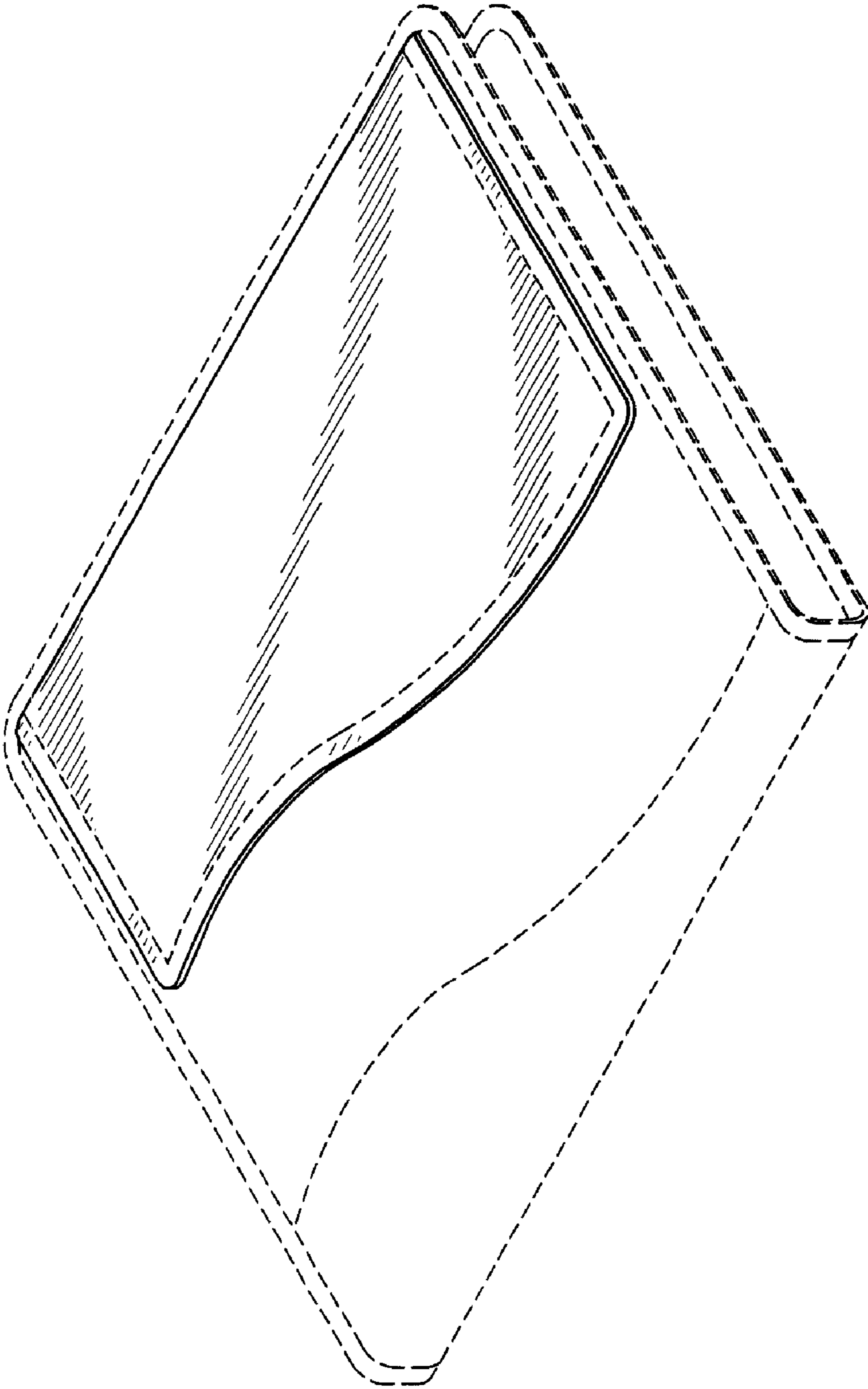

FIG. 2

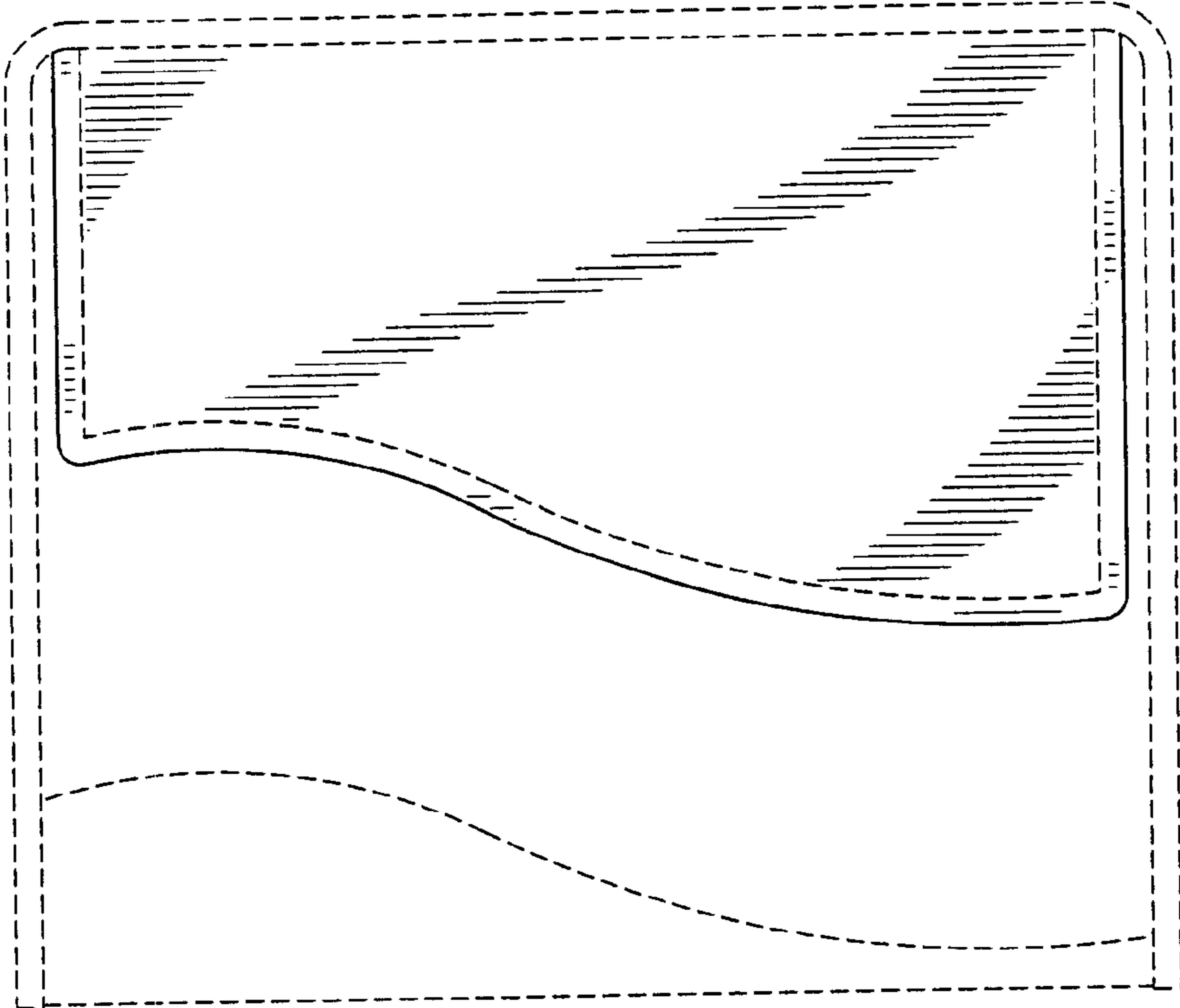

FIG. 3

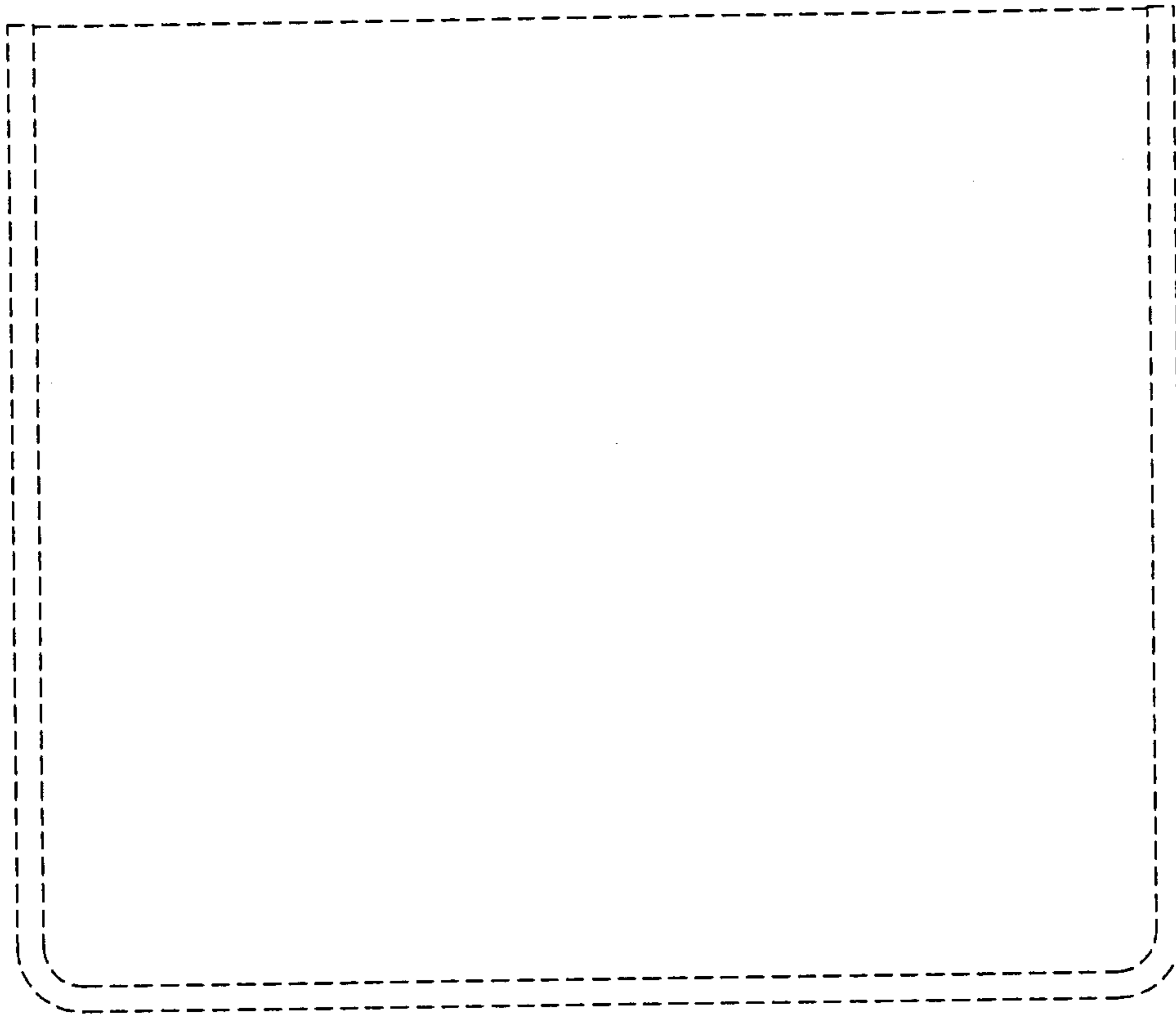

FIG. 4

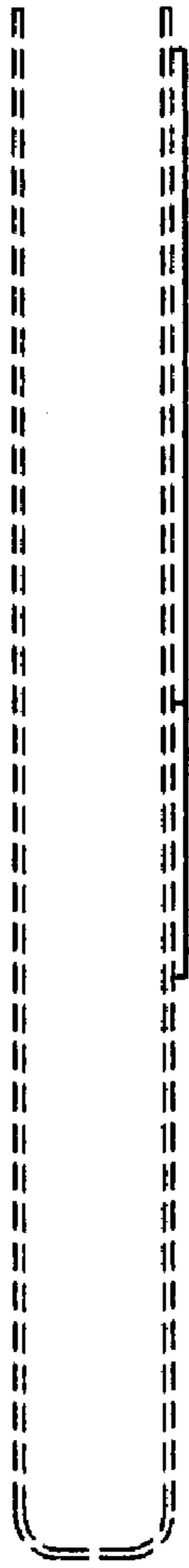

FIG. 5



FIG. 6

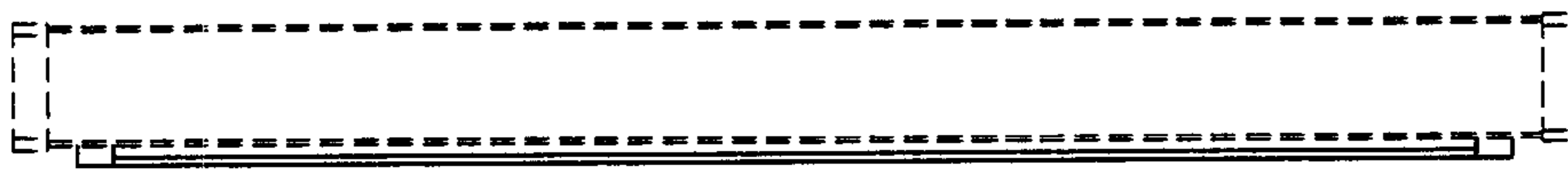

FIG. 8

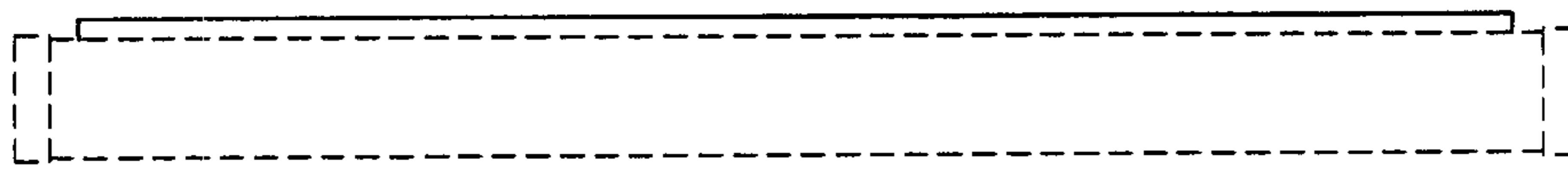

FIG. 7

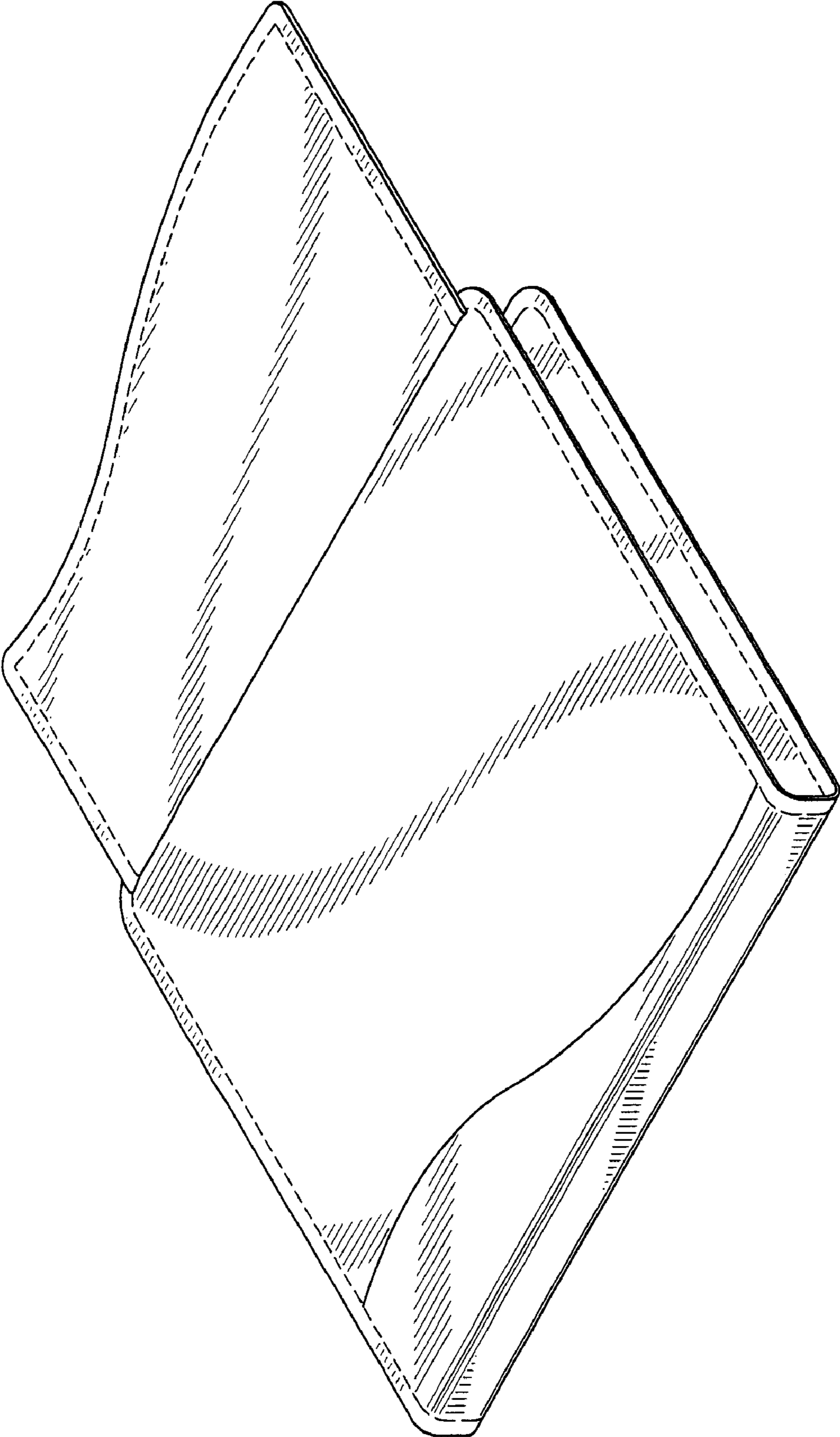

FIG. 9

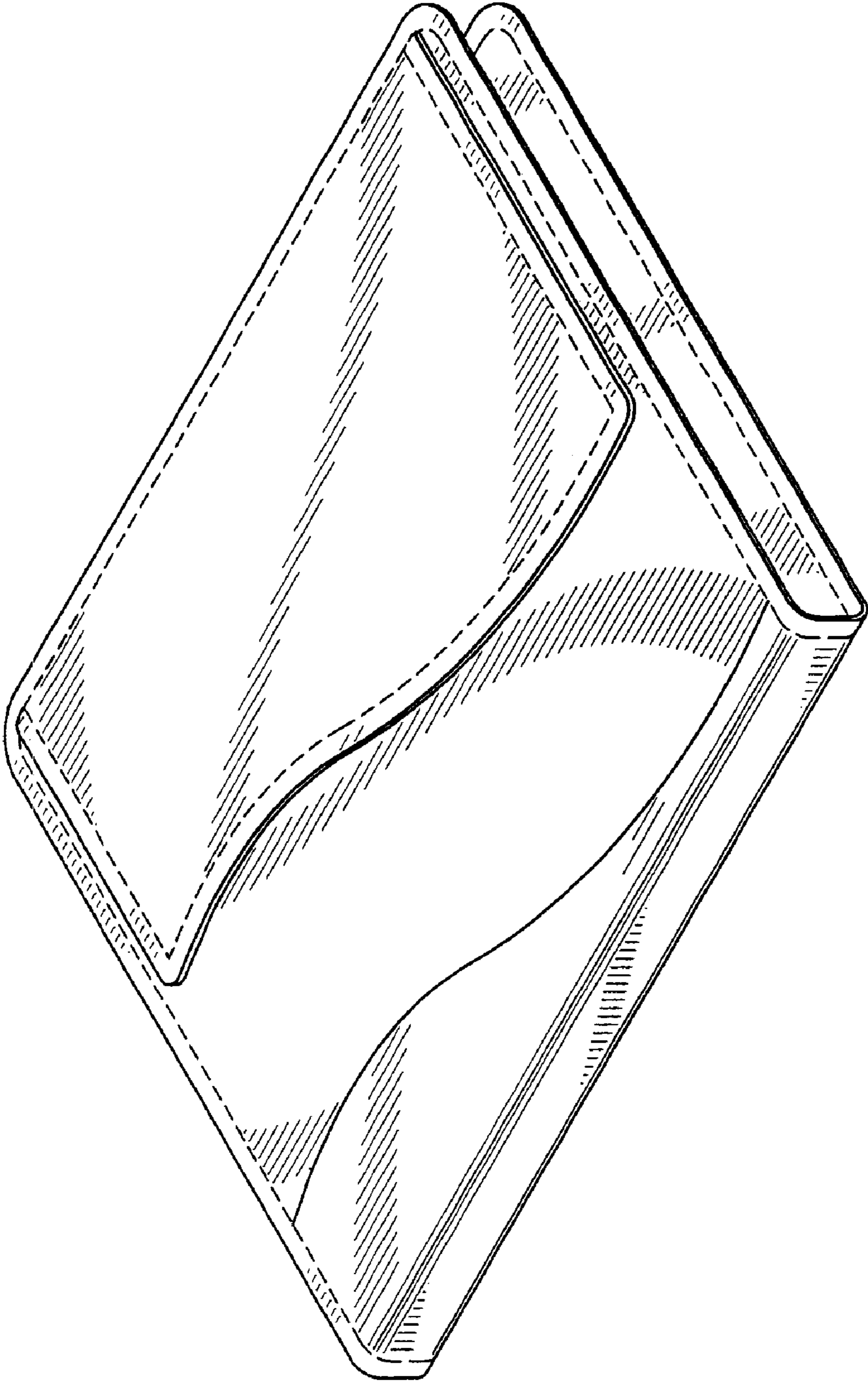

FIG. 10

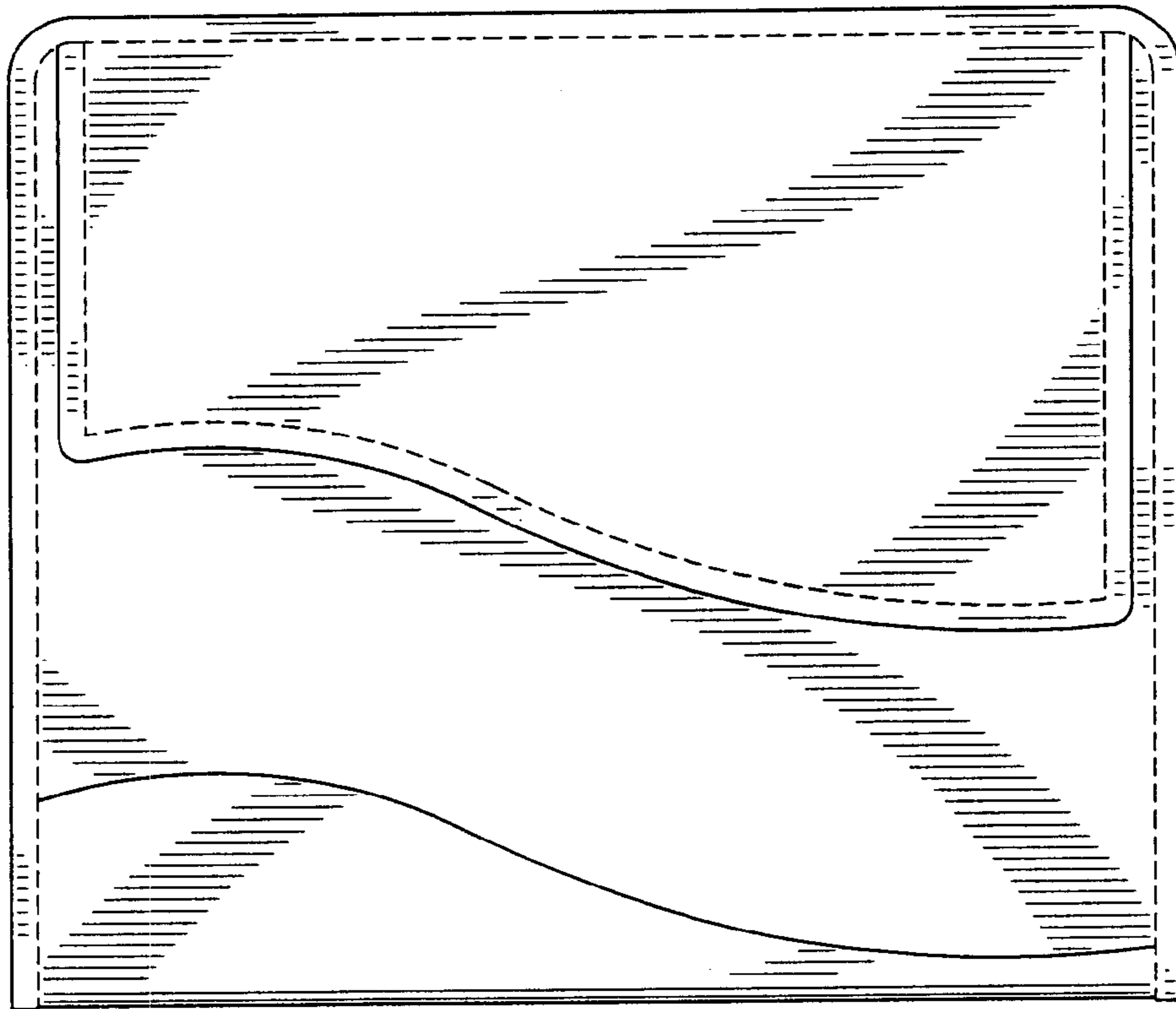

FIG. 11

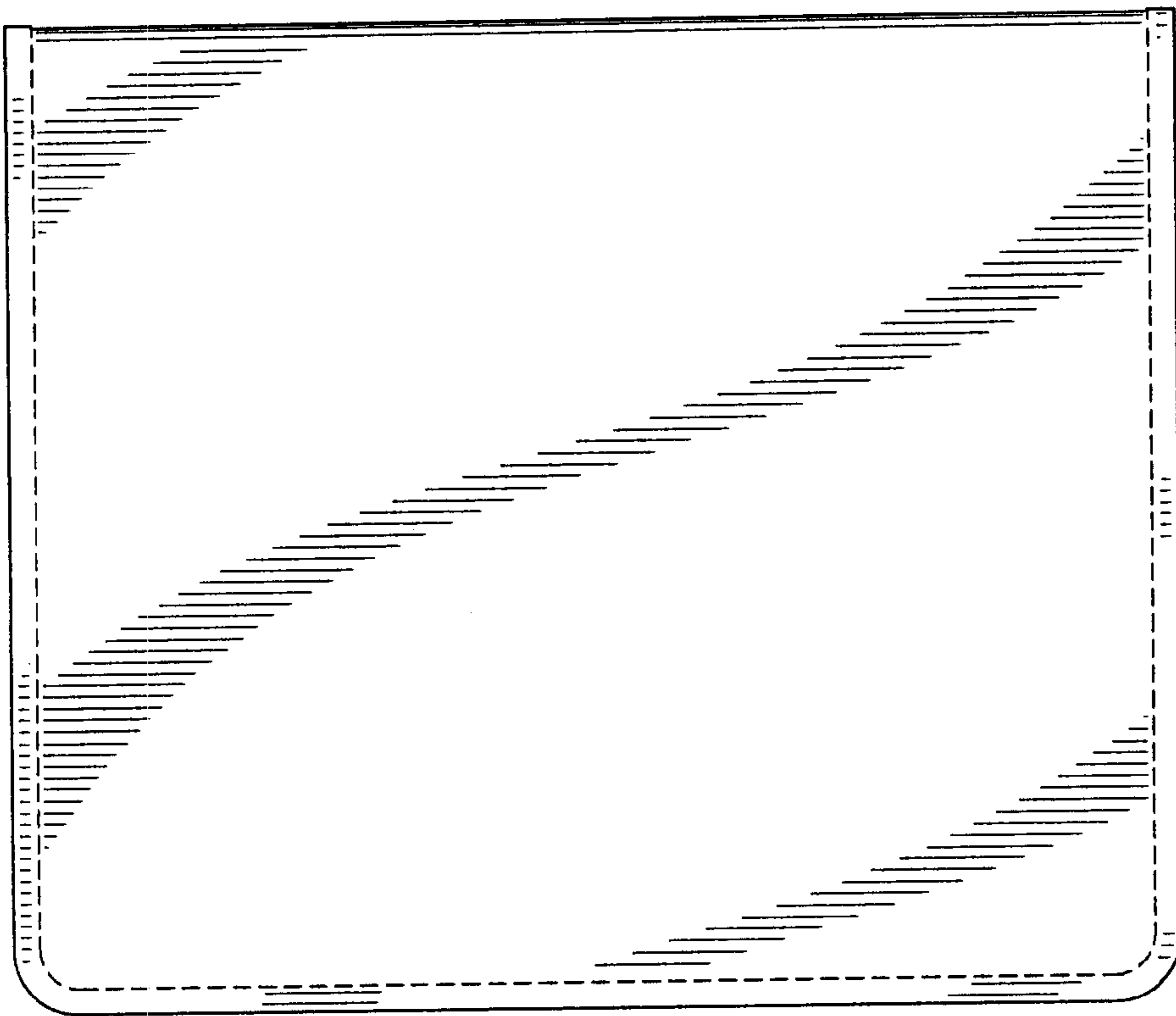

FIG. 12

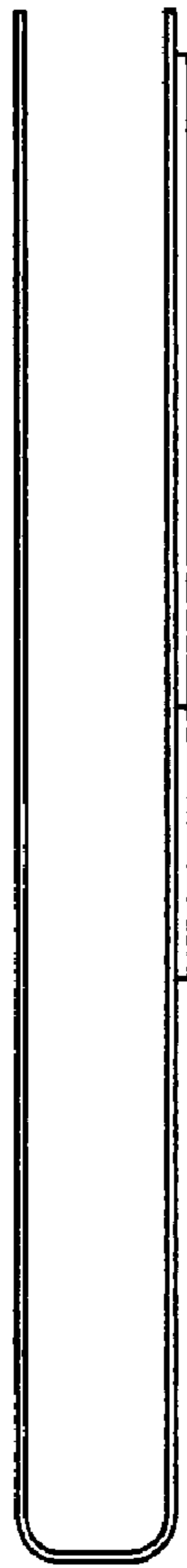

FIG. 13



FIG. 14



FIG. 16

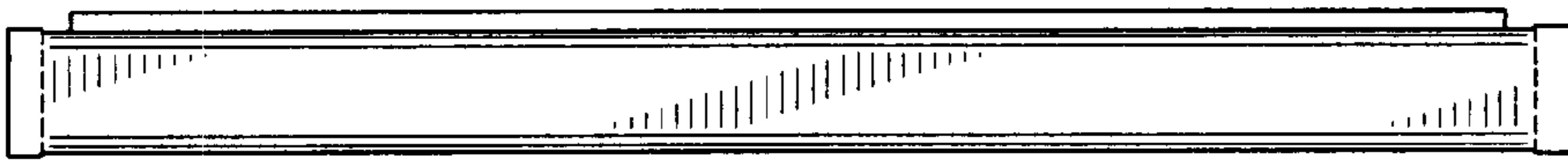

FIG. 15

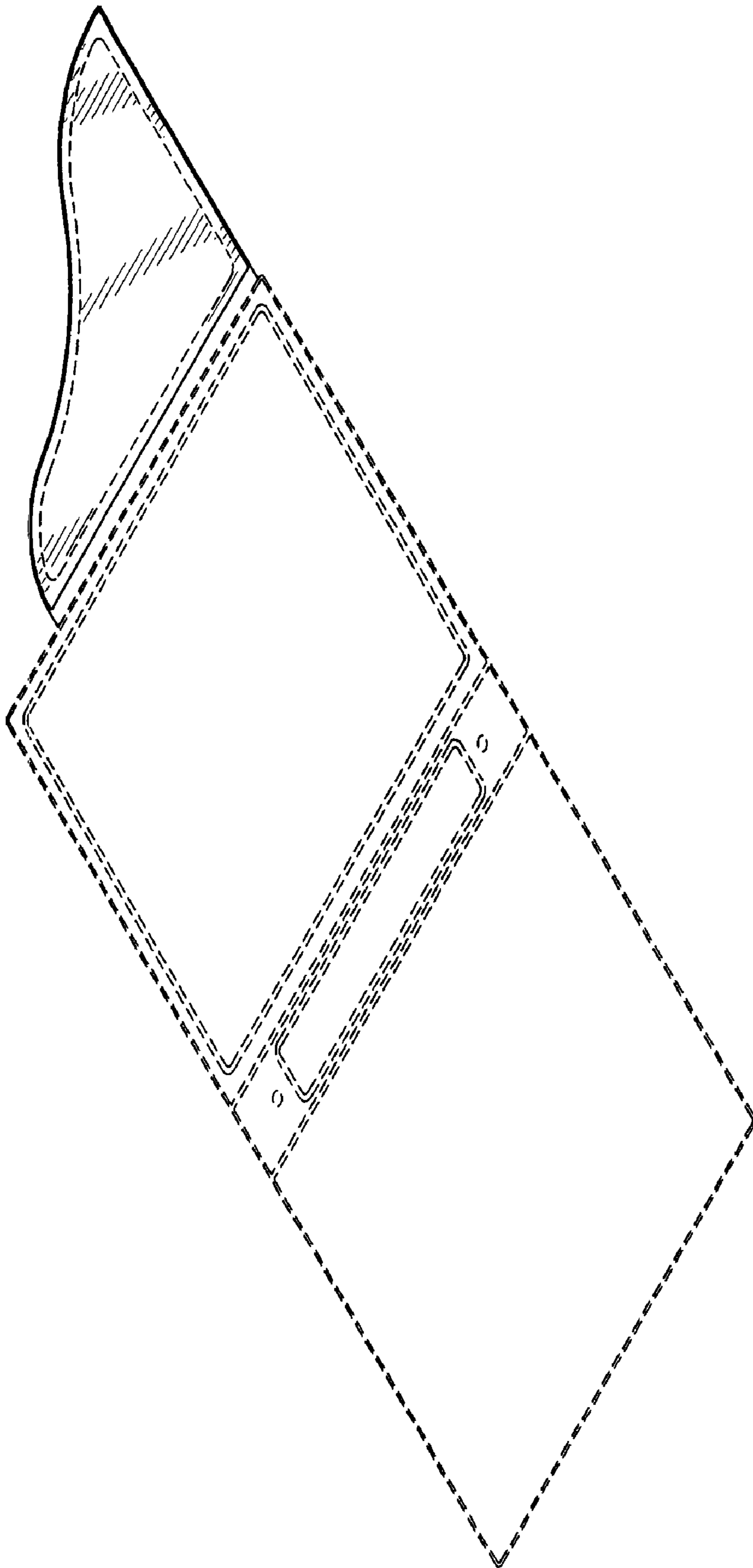

FIG. 17

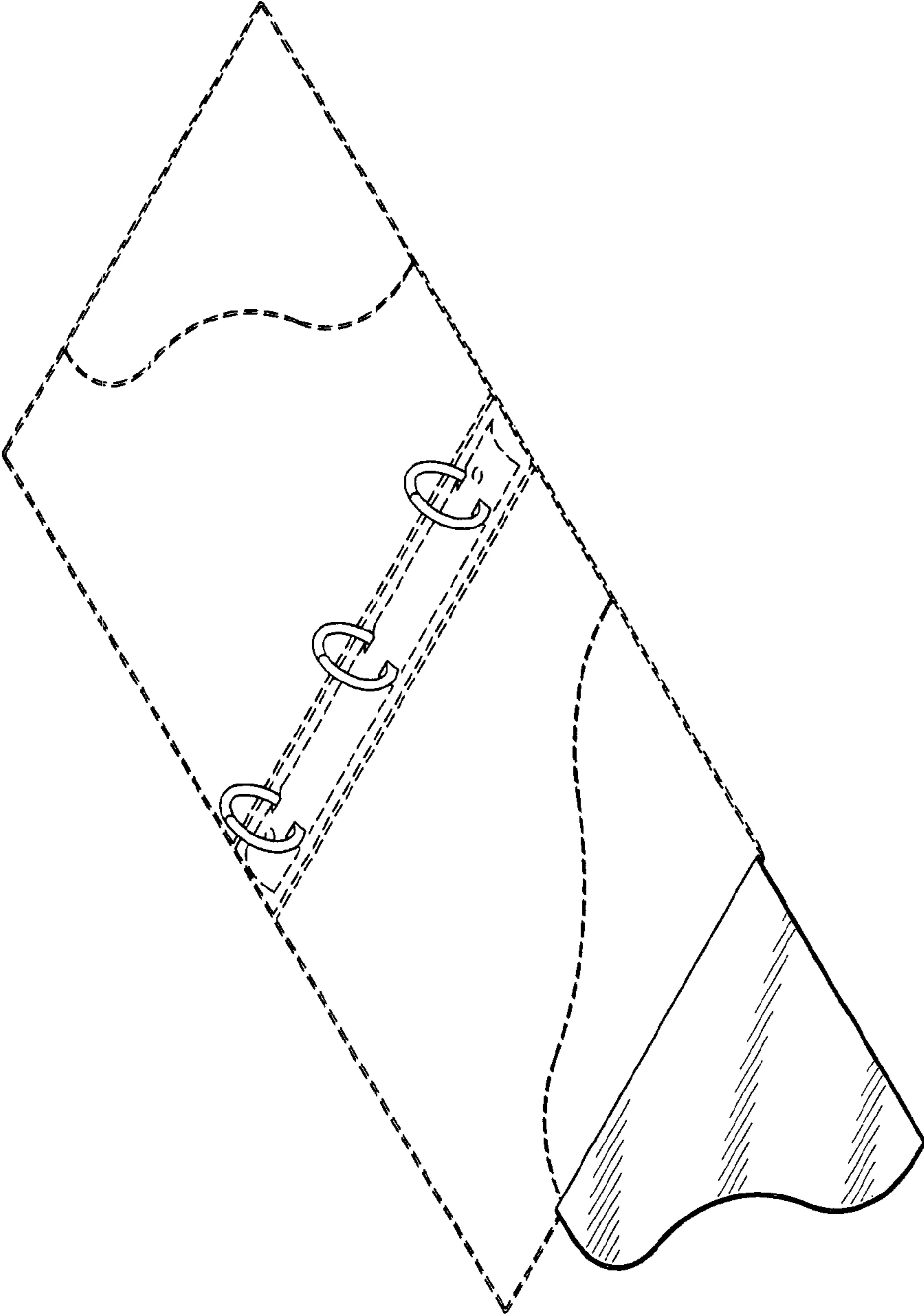

FIG. 18

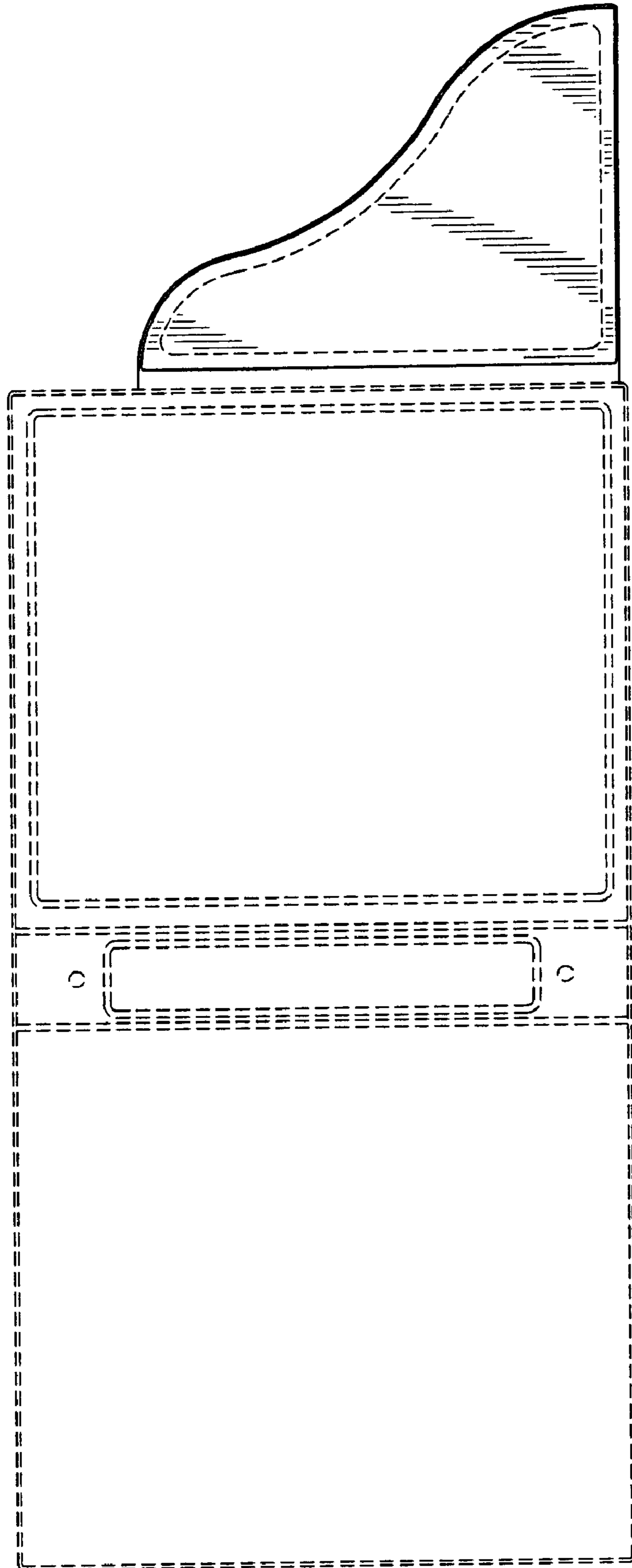

FIG. 19

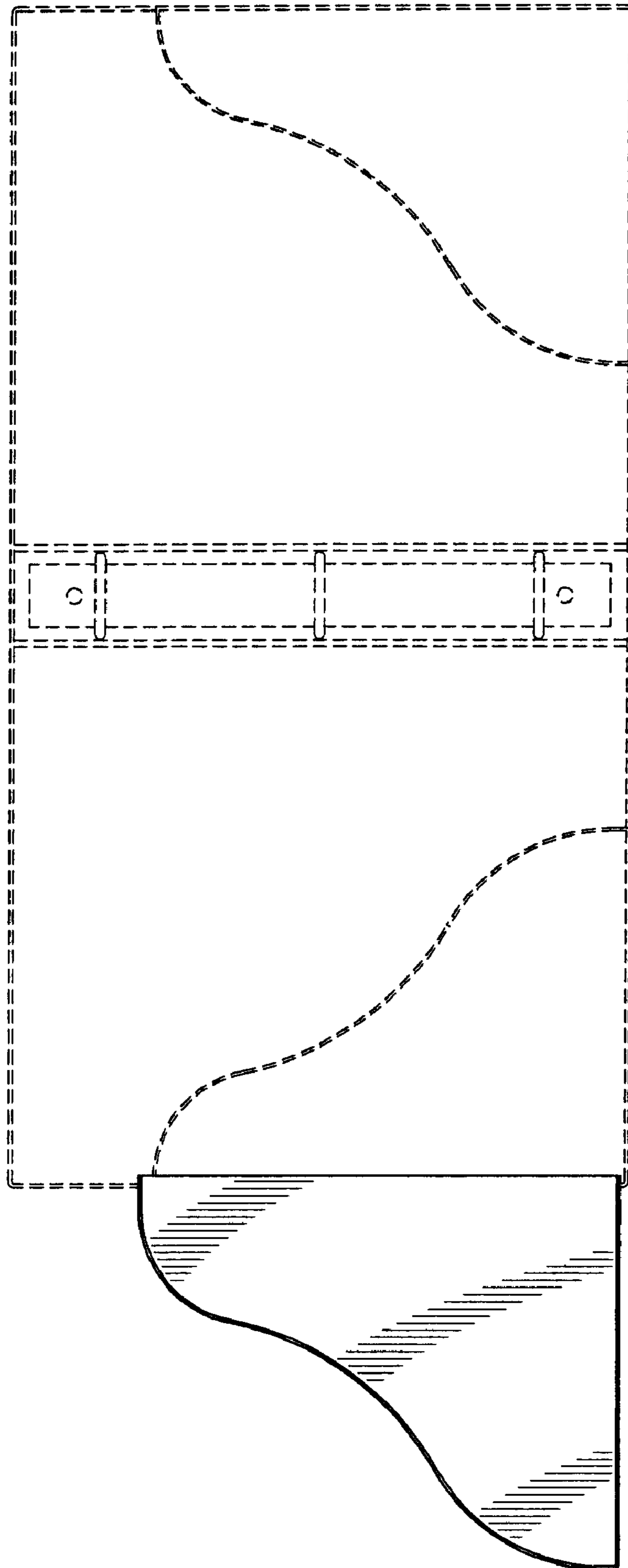

FIG. 20

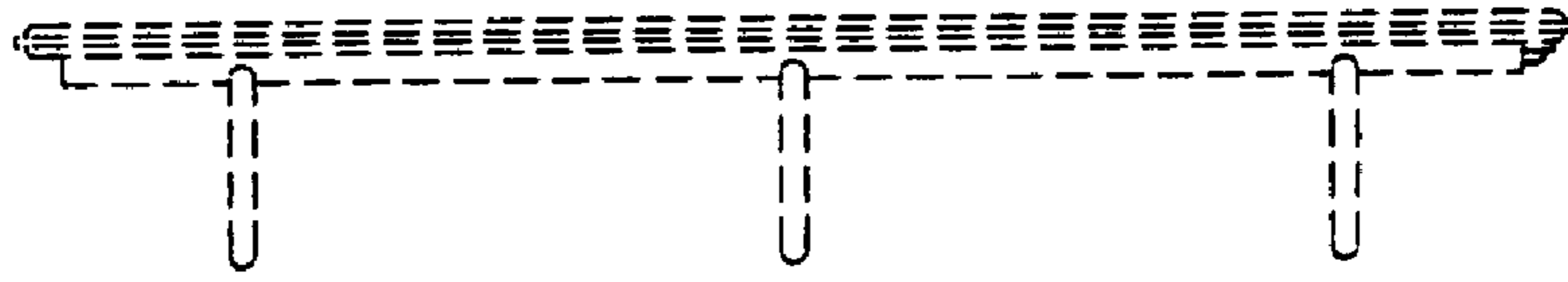

FIG. 22



FIG. 21

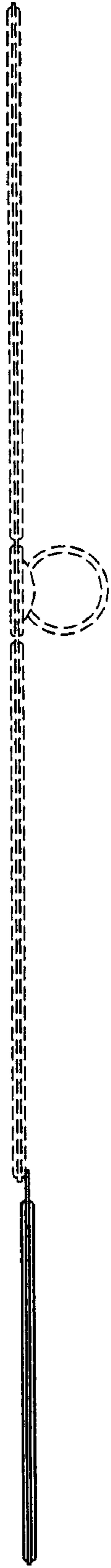

FIG. 23

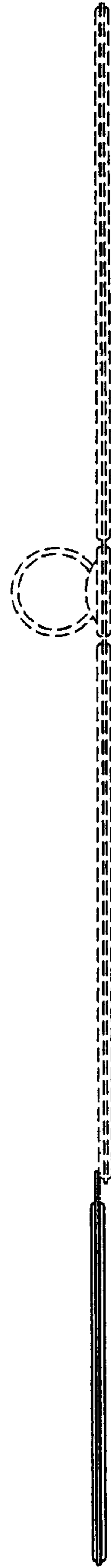

FIG. 24

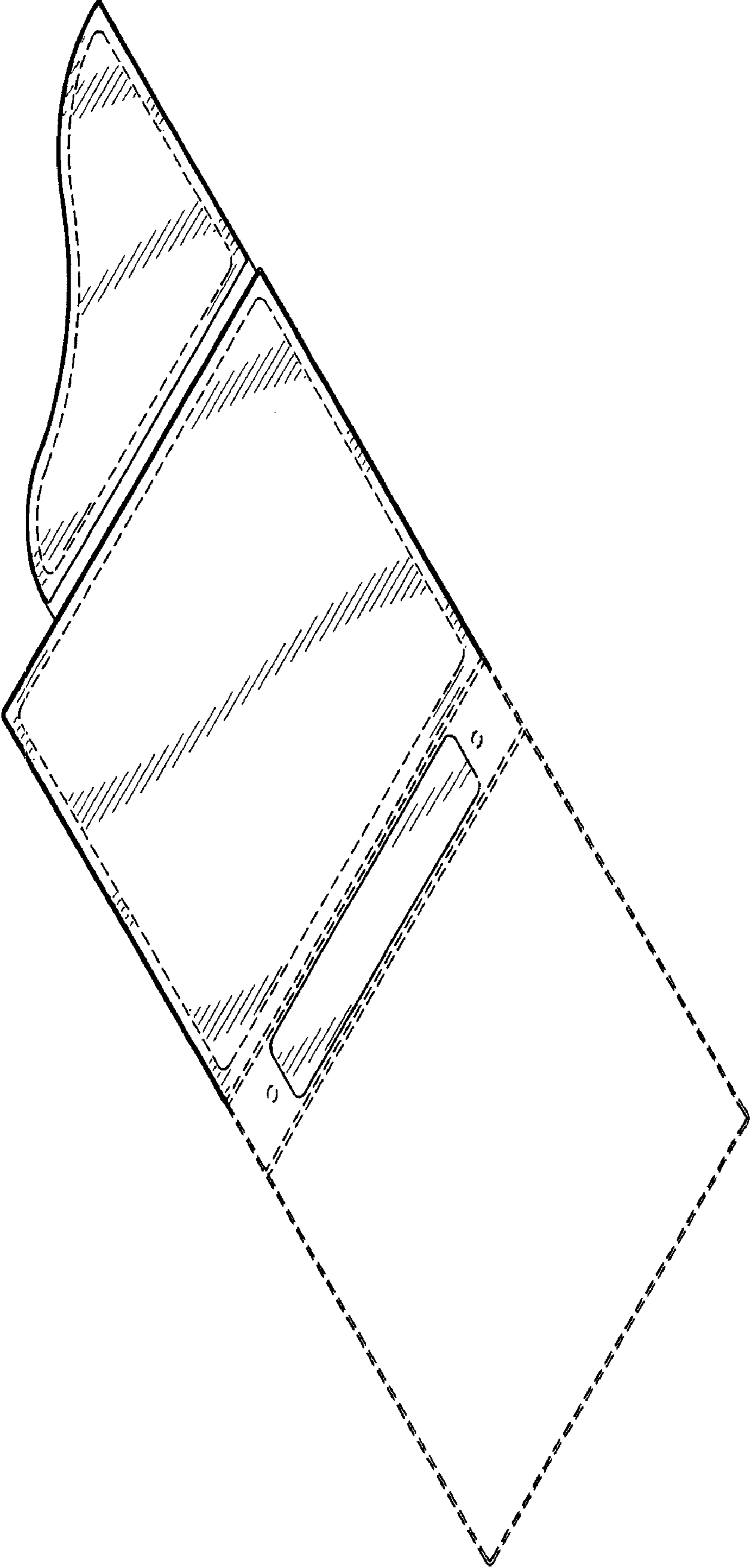

FIG. 25

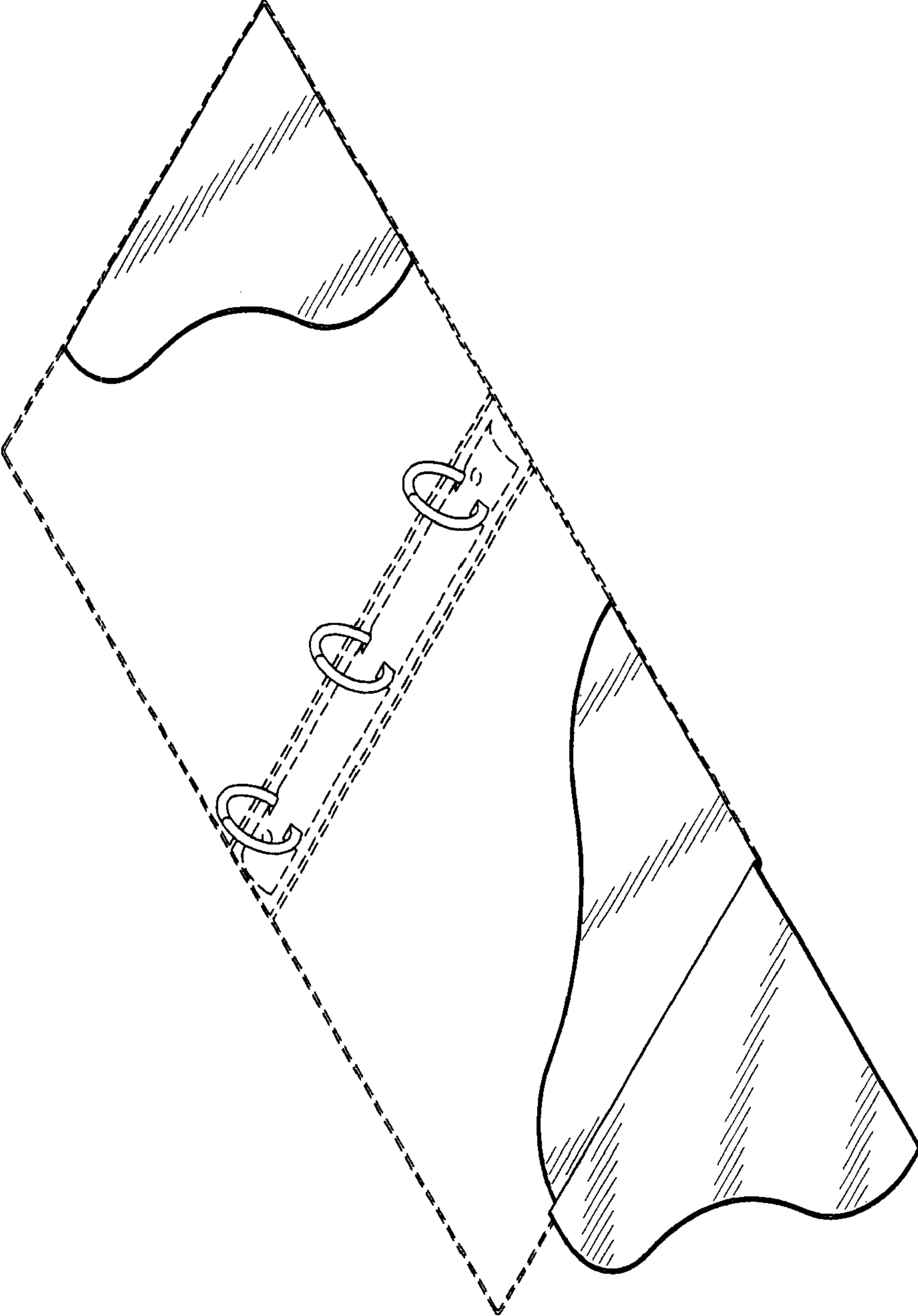

FIG. 26

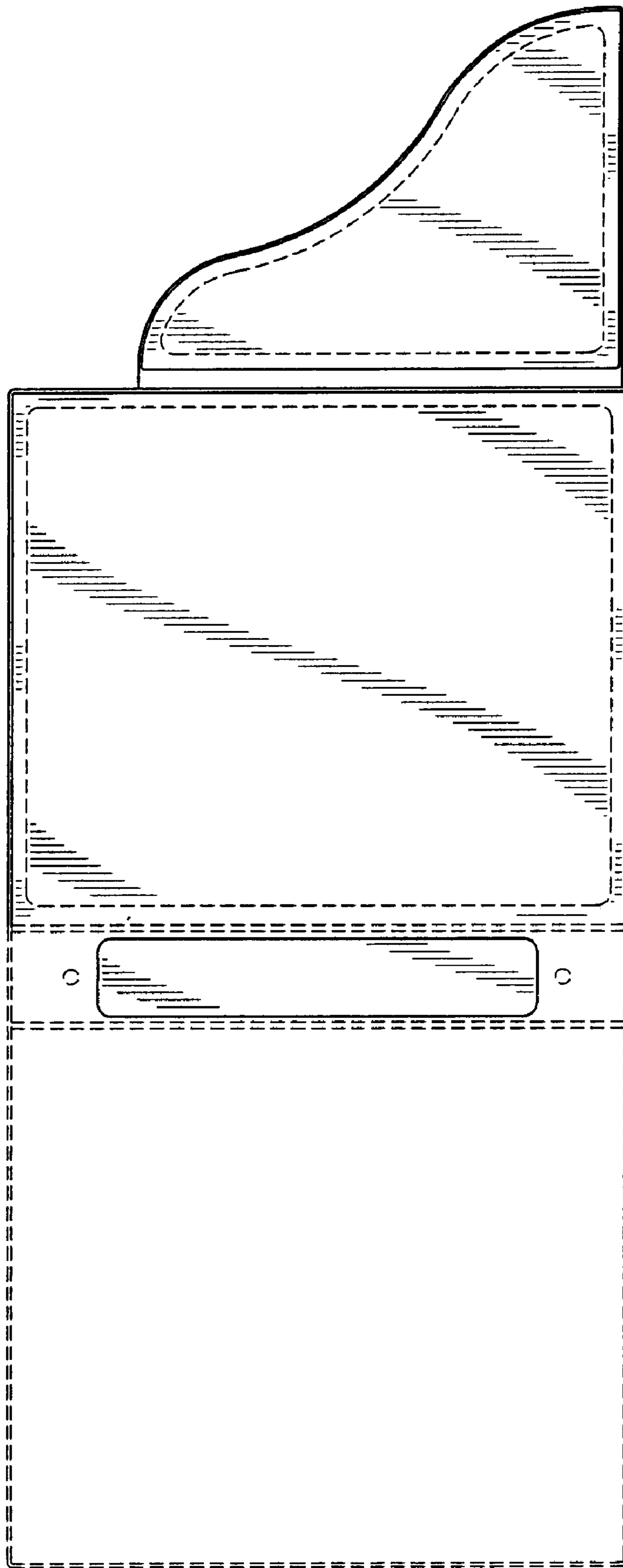

FIG. 27

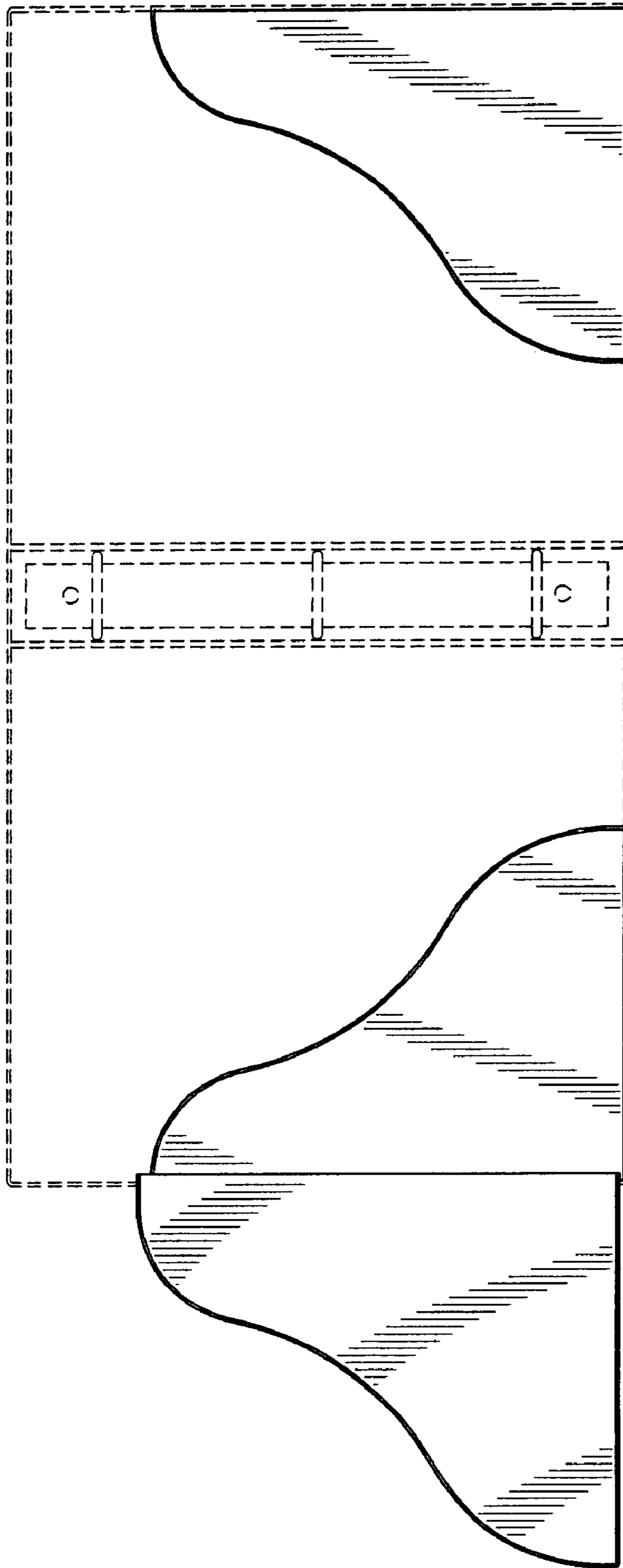

FIG. 28

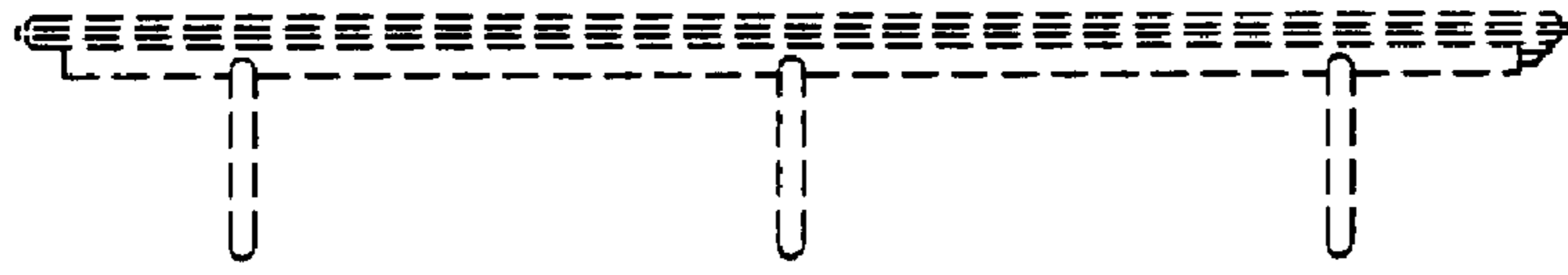

FIG. 30



FIG. 29

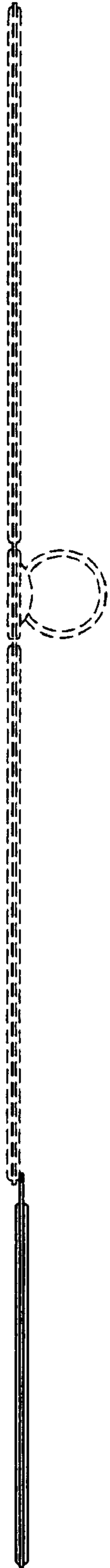

FIG. 31



FIG. 32