



US00D536319S

(12) **United States Design Patent**  
**Kim**

(10) **Patent No.:** **US D536,319 S**

(45) **Date of Patent:** **\*\* Feb. 6, 2007**

(54) **CELLULAR PHONE**

(75) Inventor: **Dae Hee Kim**, Seoul (KR)

(73) Assignee: **Pantech & Curitel Communications, Inc.** (KR)

(\*\*) Term: **14 Years**

(21) Appl. No.: **29/228,439**

(22) Filed: **Apr. 21, 2005**

(51) **LOC (8) Cl.** ..... **14-03**

(52) **U.S. Cl.** ..... **D14/138**

(58) **Field of Classification Search** ..... D14/191,  
D14/138, 147-148, 247-248, 144, 496, 156,  
D14/341-347; 379/433.01-433.13; 455/575.3,  
455/566, 575.1, 556.1, 556.2, 90.3; D21/517;  
D16/208

See application file for complete search history.

(56) **References Cited**

**U.S. PATENT DOCUMENTS**

D486,809 S	*	2/2004	Hwang	.....	D14/138
D489,345 S	*	5/2004	Shimamura et al.	.....	D14/138
D491,547 S	*	6/2004	Cho	.....	D14/138
D491,906 S	*	6/2004	Okamatsu	.....	D14/138
D491,907 S	*	6/2004	Ogawa	.....	D14/138
D496,347 S	*	9/2004	Choi et al.	.....	D14/191
D500,016 S	*	12/2004	Kim	.....	D14/138
D501,189 S	*	1/2005	Lodato et al.	.....	D14/138
D505,124 S	*	5/2005	Takada	.....	D14/138
D506,454 S	*	6/2005	Kim et al.	.....	D14/138
D507,255 S	*	7/2005	Watanabe et al.	.....	D14/138
D507,552 S	*	7/2005	Liang	.....	D14/138
D508,474 S	*	8/2005	Ribeiro et al.	.....	D14/138
D508,475 S	*	8/2005	Wu et al.	.....	D14/138
D508,476 S	*	8/2005	Kim	.....	D14/138
D510,079 S	*	9/2005	Kim et al.	.....	D14/138
D510,733 S	*	10/2005	Lee et al.	.....	D14/138
D512,038 S	*	11/2005	Kim et al.	.....	D14/138
D513,505 S	*	1/2006	Lee	.....	D14/138
D515,061 S	*	2/2006	Kim et al.	.....	D14/138
D518,015 S	*	3/2006	Cho	.....	D14/138

D518,465 S	*	4/2006	Van Den Nieuwenhuizen et al.	.....	D14/138
D518,809 S	*	4/2006	Cho	.....	D14/138
D519,969 S	*	5/2006	Sutherland et al.	.....	D14/138
D520,484 S	*	5/2006	Lee et al.	.....	D14/138
D524,787 S	*	7/2006	Watanabe et al.	.....	D14/138
2004/0214619 A1	*	10/2004	Chiang	.....	455/575.3

**FOREIGN PATENT DOCUMENTS**

JP	1167658	*	3/2003
JP	1185434	*	9/2003
WO	DM/064560	*	10/2003

**OTHER PUBLICATIONS**

Motorola A668 telephone, announced 4th Quarter 2004, [online], [retrieved on Aug. 18, 2006]. Retrieved from Internet ,<URL: http://www.gsmarena.com>.\*

Motorola E1070 telephone, announced 4th Quarter 2005, [online], [retrieved on Aug. 21, 2006]. Retrieved from Internet ,<URL: http://www.gsmarena.com>.\*

Sony Ericsson Z1010 telephone, announced 4th Quarter 2003, [online], [retrieved on Aug. 21, 2006]. Retrieved from Internet ,<URL: http://www.gsmarena.com>.\*

\* cited by examiner

*Primary Examiner*—Jeffrey Asch

(74) *Attorney, Agent, or Firm*—Blakely Sokoloff Taylor & Zafman

(57) **CLAIM**

The ornamental design for a cellular phone, as shown and described.

**DESCRIPTION**

FIG. 1 is a perspective view of the cellular phone showing the new design;  
FIG. 2 is a front view thereof;  
FIG. 3 is a rear view thereof;  
FIG. 4 is a left-side view thereof;  
FIG. 5 is a right-side view thereof;  
FIG. 6 is a top plan view thereof;  
FIG. 7 is a bottom view thereof; and,  
FIG. 8 is a front view showing open position thereof.

**1 Claim, 5 Drawing Sheets**

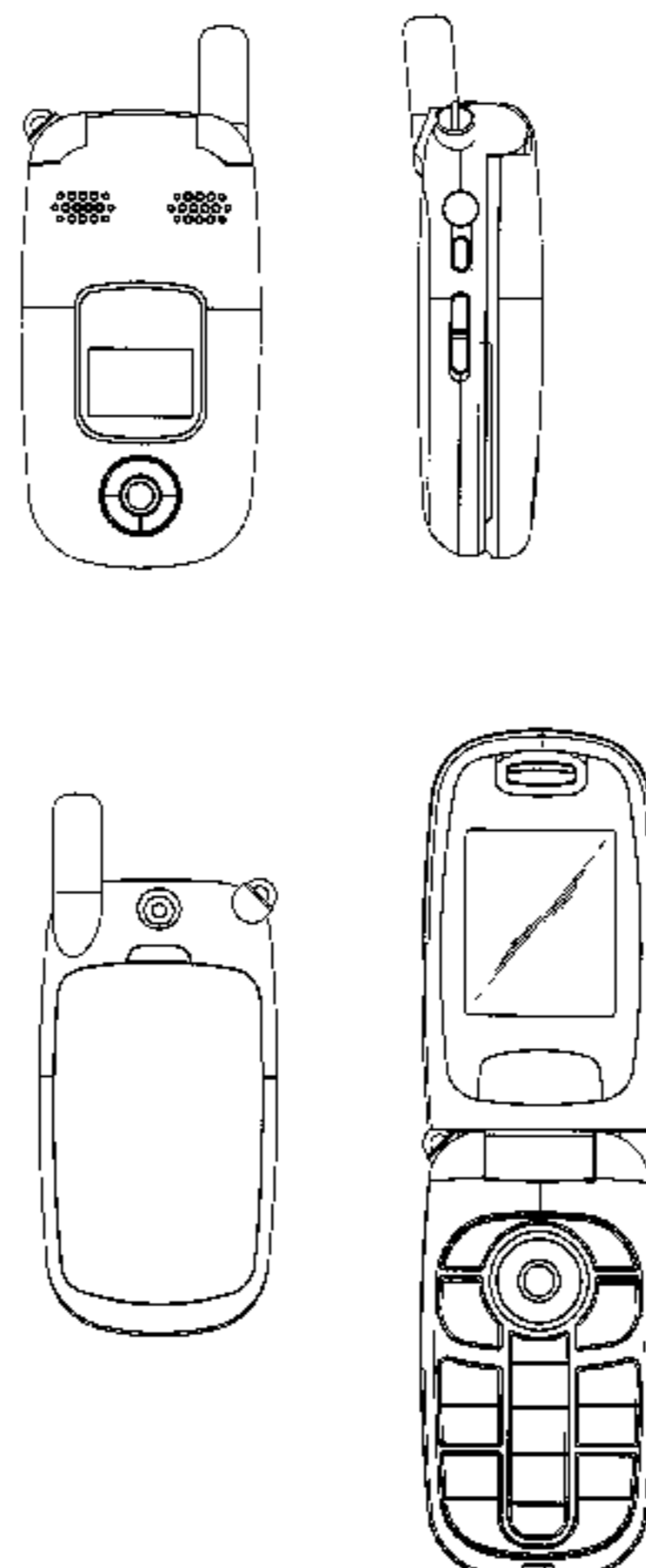

FIG. 1

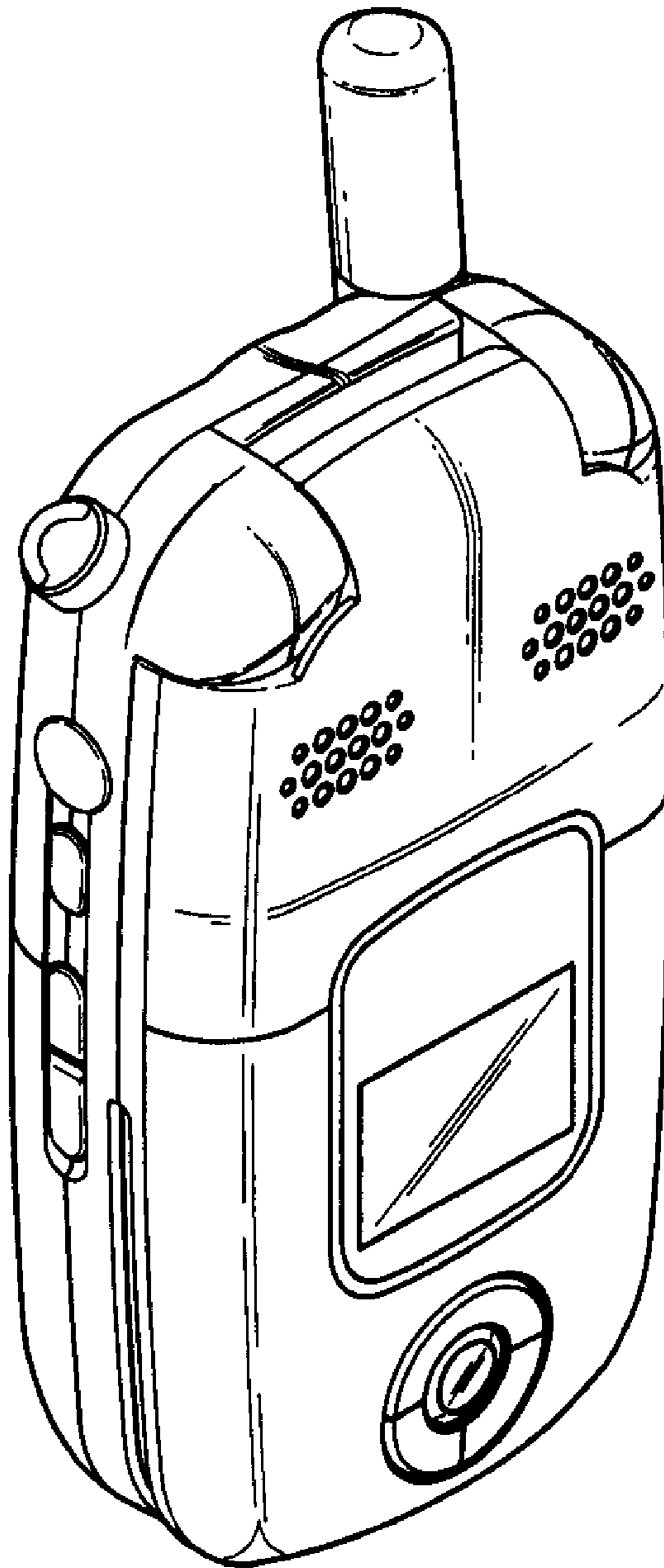

FIG. 2

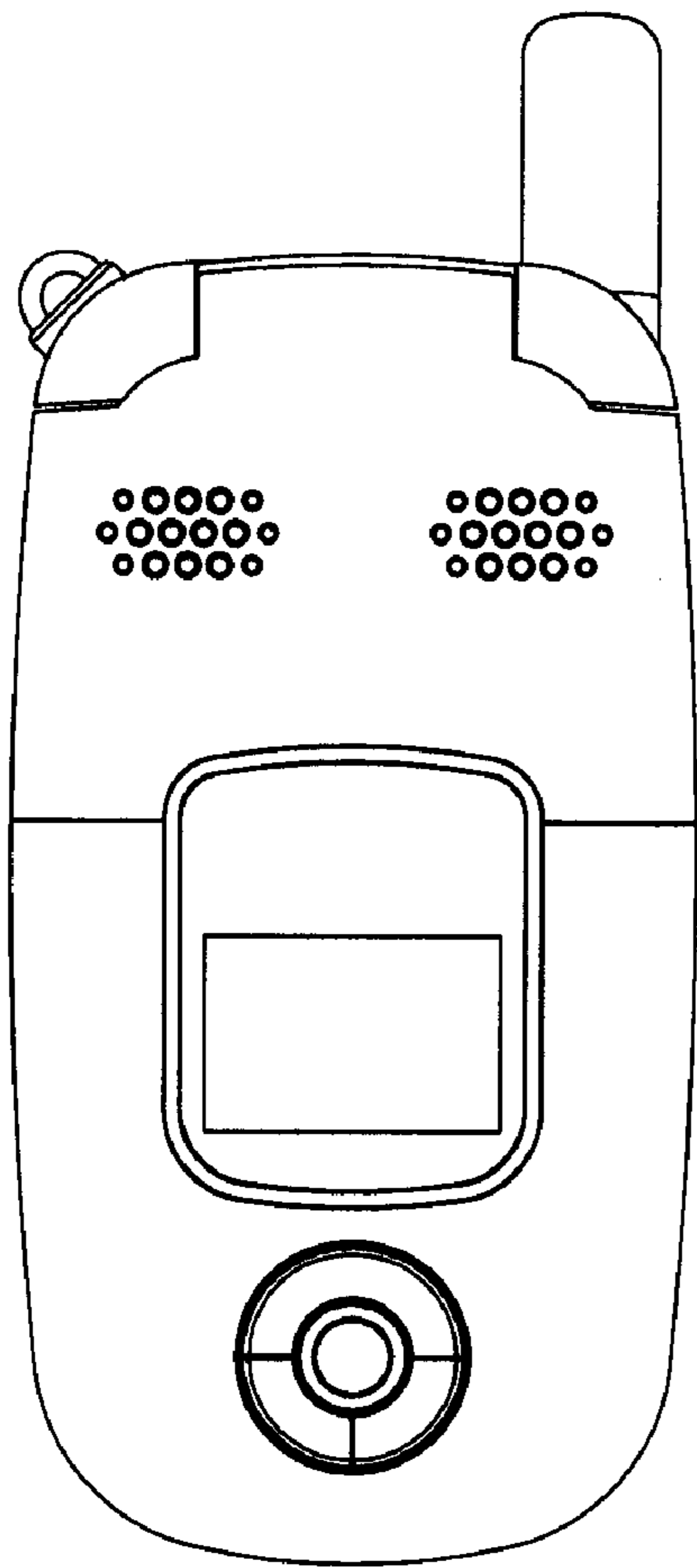

FIG. 3

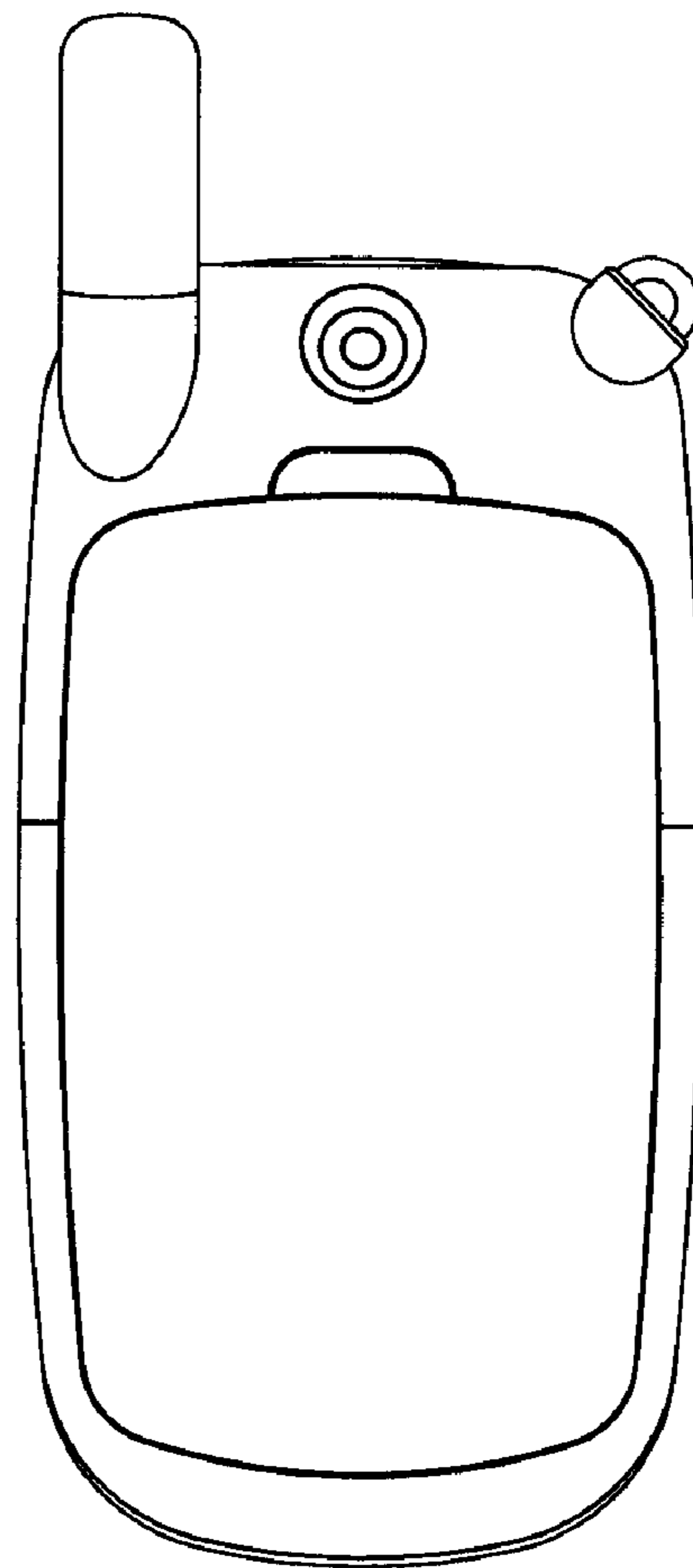

FIG. 4

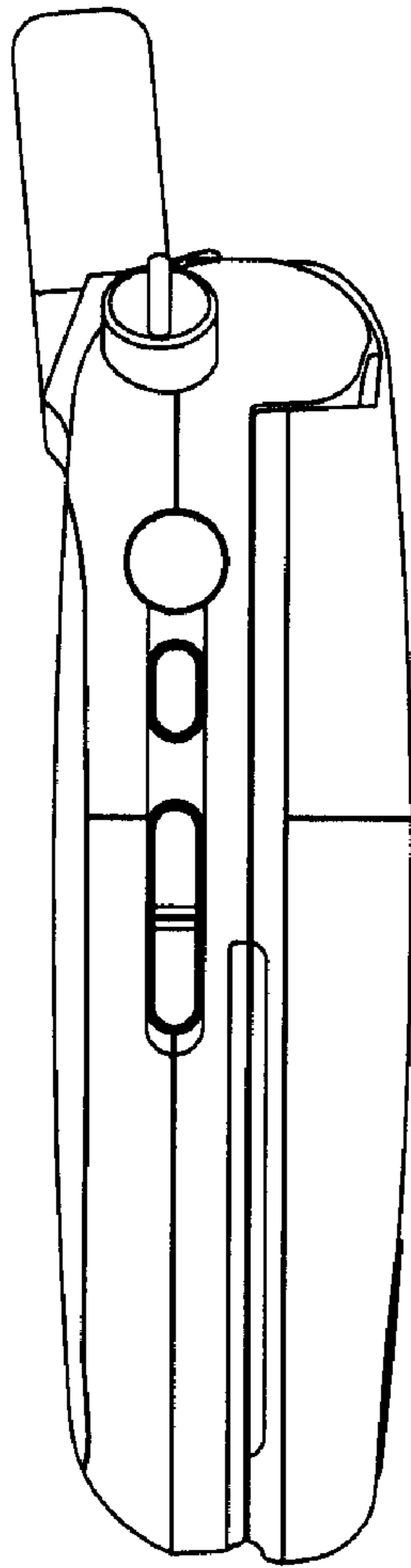

FIG. 5

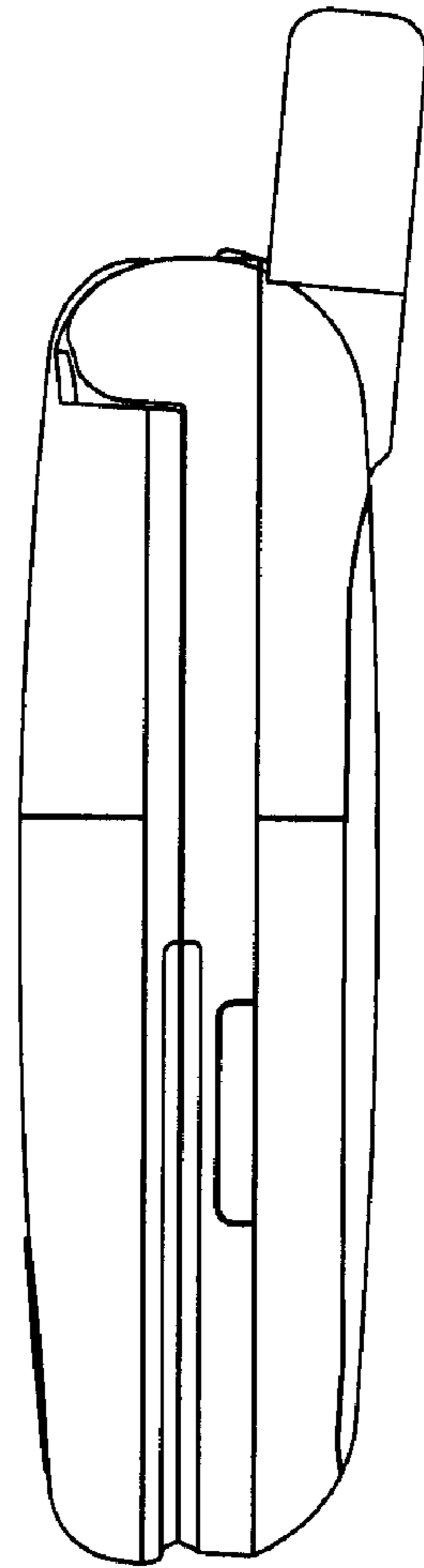

FIG. 6

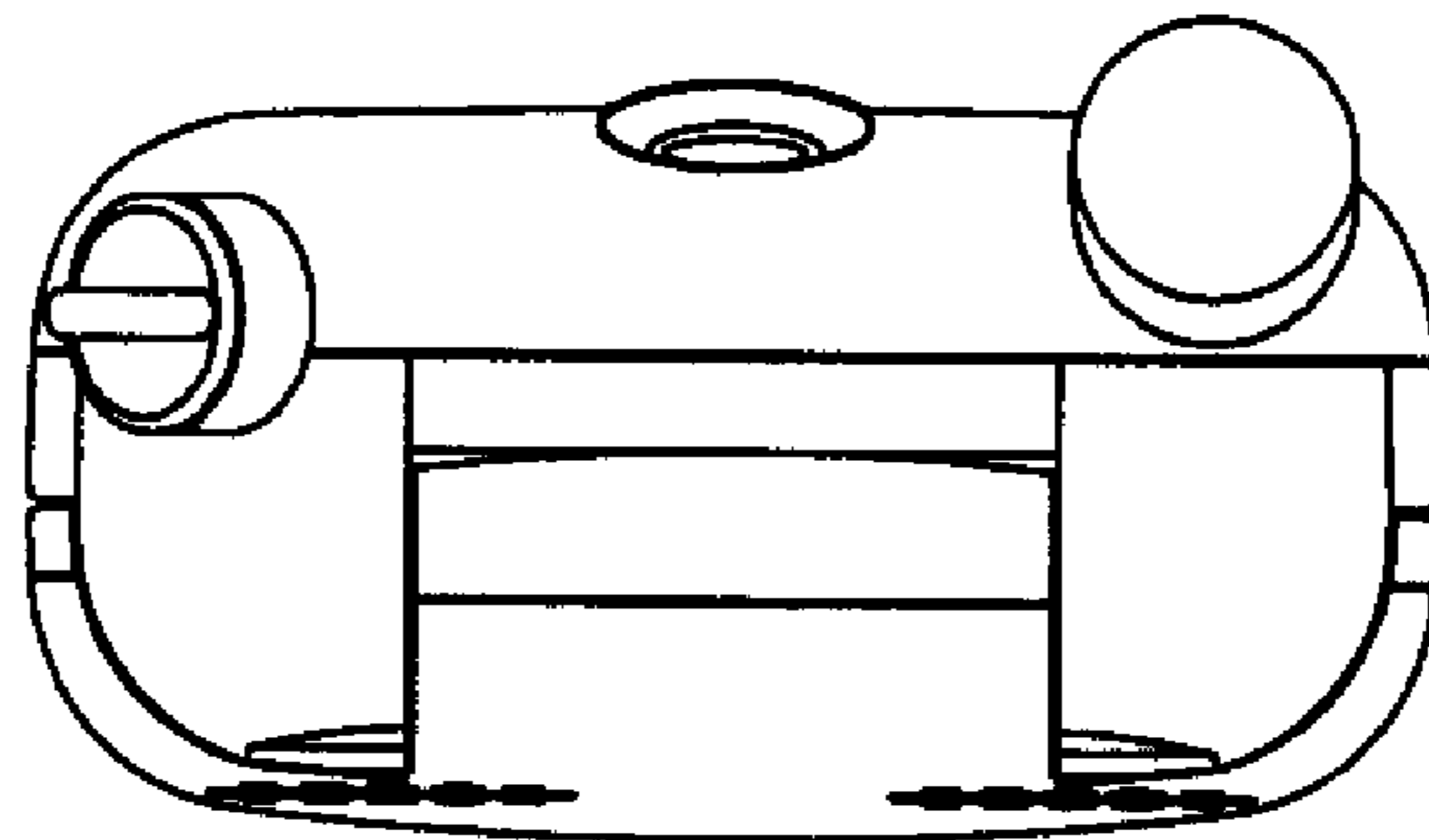

FIG. 7

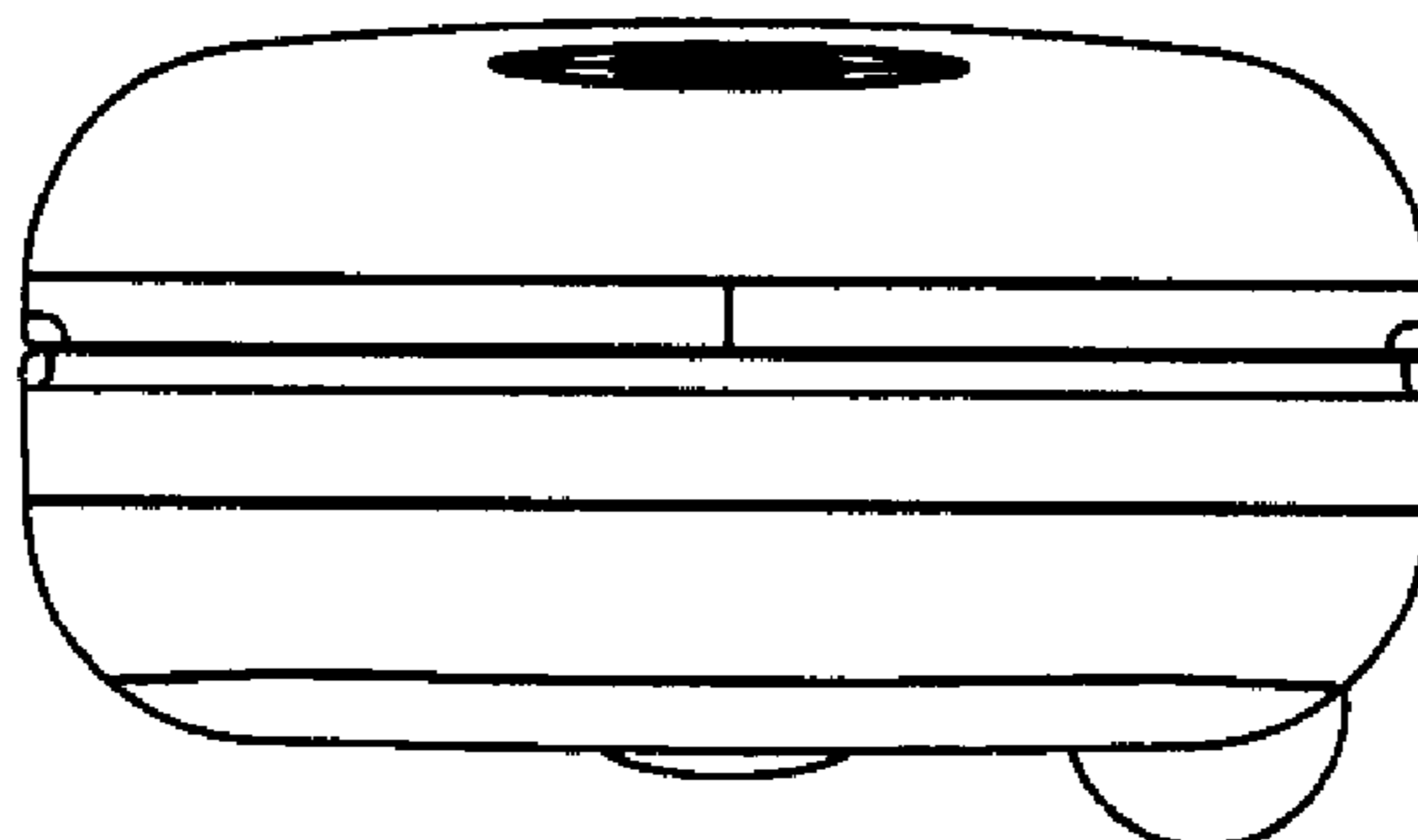

FIG. 8

