



US00D536308S

(12) **United States Design Patent** (10) **Patent No.:** **US D536,308 S**  
**Inoue** (45) **Date of Patent:** **\*\* Feb. 6, 2007**

(54) **LIGHT EMITTING DIODE**

(75) Inventor: **Tomio Inoue**, Kyoto (JP)

(73) Assignee: **Rohm Co., Ltd.**, Kyoto (JP)

(\*\*) Term: **14 Years**

(21) Appl. No.: **29/228,152**

(22) Filed: **Apr. 19, 2005**

(30) **Foreign Application Priority Data**

Oct. 19, 2004	(JP)	.....	2004-031704
Oct. 19, 2004	(JP)	.....	2004-031705
Oct. 19, 2004	(JP)	.....	2004-031706
Oct. 19, 2004	(JP)	.....	2004-031707
Oct. 19, 2004	(JP)	.....	2004-031716
Oct. 19, 2004	(JP)	.....	2004-031717
Oct. 19, 2004	(JP)	.....	2004-031718
Oct. 19, 2004	(JP)	.....	2004-031719

(51) **LOC (8) Cl.** ..... **13-03**

(52) **U.S. Cl.** ..... **D13/180**

(58) **Field of Classification Search** ..... D13/180;  
D26/2; 257/79, 80, 81, 82, 88, 89, 95, 98,  
257/99, 100, 678, 680, 433, 434, 666; 313/483,  
313/498, 500; 361/820; 382/235, 249, 555,  
382/800; 372/45.01

See application file for complete search history.

(56) **References Cited**

**U.S. PATENT DOCUMENTS**

4,843,280	A *	6/1989	Lumbard et al.	.....	313/500
6,015,719	A *	1/2000	Kish et al.	.....	438/29
6,120,600	A *	9/2000	Edmond et al.	.....	117/89
6,404,125	B1 *	6/2002	Garbuzov et al.	.....	313/499
D476,961	S *	7/2003	Horiuchi et al.	.....	D13/182
6,730,939	B2 *	5/2004	Eisert et al.	.....	257/98
6,740,906	B2 *	5/2004	Slater et al.	.....	257/99
6,774,406	B2 *	8/2004	Isoda	.....	257/99
6,853,010	B2 *	2/2005	Slater et al.	.....	257/98
6,956,241	B2 *	10/2005	Sugawara et al.	.....	257/79
2002/0056848	A1 *	5/2002	Wirth	.....	257/98
2002/0123164	A1 *	9/2002	Slater et al.	.....	438/39
2003/0155580	A1 *	8/2003	Eisert et al.	.....	257/98

2003/0173575	A1 *	9/2003	Eisert et al.	.....	257/95
2004/0061440	A1 *	4/2004	Imai et al.	.....	313/512
2004/0070338	A1 *	4/2004	Noguchi et al.	.....	313/512
2005/0173721	A1 *	8/2005	Isoda	.....	257/99
2005/0253157	A1 *	11/2005	Ohashi et al.	.....	257/95

\* cited by examiner

*Primary Examiner*—Selina Sikder

(74) *Attorney, Agent, or Firm*—Hamre, Schumann, Mueller & Larson, P.C.

(57) **CLAIM**

I claim the ornamental design for a light emitting diode, as shown.

**DESCRIPTION**

FIG. 1 is a front view of a light emitting diode showing a first embodiment of my new design, the rear being a mirror image thereof;

FIG. 2 is a top plan view thereof;

FIG. 3 is a right side view, the left side view being a mirror image thereof;

FIG. 4 is a bottom view thereof;

FIG. 5 is a sectional view taken along line 5—5 in FIG. 2; and

FIG. 6 is a perspective view thereof;

FIG. 7 is a front view of a light emitting diode showing a second embodiment, the rear being a mirror image thereof;

FIG. 8 is a top plan view thereof;

FIG. 9 is a right side view, the left side view being a mirror image thereof;

FIG. 10 is a bottom view thereof;

FIG. 11 is a sectional view taken along line 11—11 in FIG. 8; and,

FIG. 12 is a perspective view thereof;

FIG. 13 is a front view of a light emitting diode showing a third embodiment, the rear being a mirror image thereof;

FIG. 14 is a top plan view thereof;

FIG. 15 is a right side view, the left side view being a mirror image thereof;

FIG. 16 is a bottom view thereof;

FIG. 17 is a sectional view taken along line 17—17 in FIG. 14; and

FIG. 18 is a perspective view thereof;



FIG. 19 is a front view of a light emitting diode showing a fourth embodiment, the rear being a mirror image thereof; FIG. 20 is a top plan view thereof; FIG. 21 is a right side view, the left side view being a mirror image thereof; FIG. 22 is a bottom view thereof; FIG. 23 is a sectional view taken along line 23—23 in FIG. 20; and FIG. 24 is a perspective view thereof; FIG. 25 is a front view of a light emitting diode showing a fifth embodiment, the rear being a mirror image thereof; FIG. 26 is a top plan view thereof; FIG. 27 is a right side view, the left side view being a mirror image thereof; FIG. 28 is a bottom view thereof;

FIG. 29 is a sectional view taken along line 29—29 in FIG. 26; and FIG. 30 is a perspective view thereof; FIG. 31 is a front view of a light emitting diode showing a sixth embodiment of my new design, the rear being a mirror image thereof; FIG. 32 is a top plan view thereof; FIG. 33 is a right side view, the left side view being a mirror image thereof; FIG. 34 is a bottom view thereof; FIG. 35 is a sectional view taken along line 35—35 in FIG. 32; and FIG. 36 is a perspective view thereof.

**1 Claim, 12 Drawing Sheets**

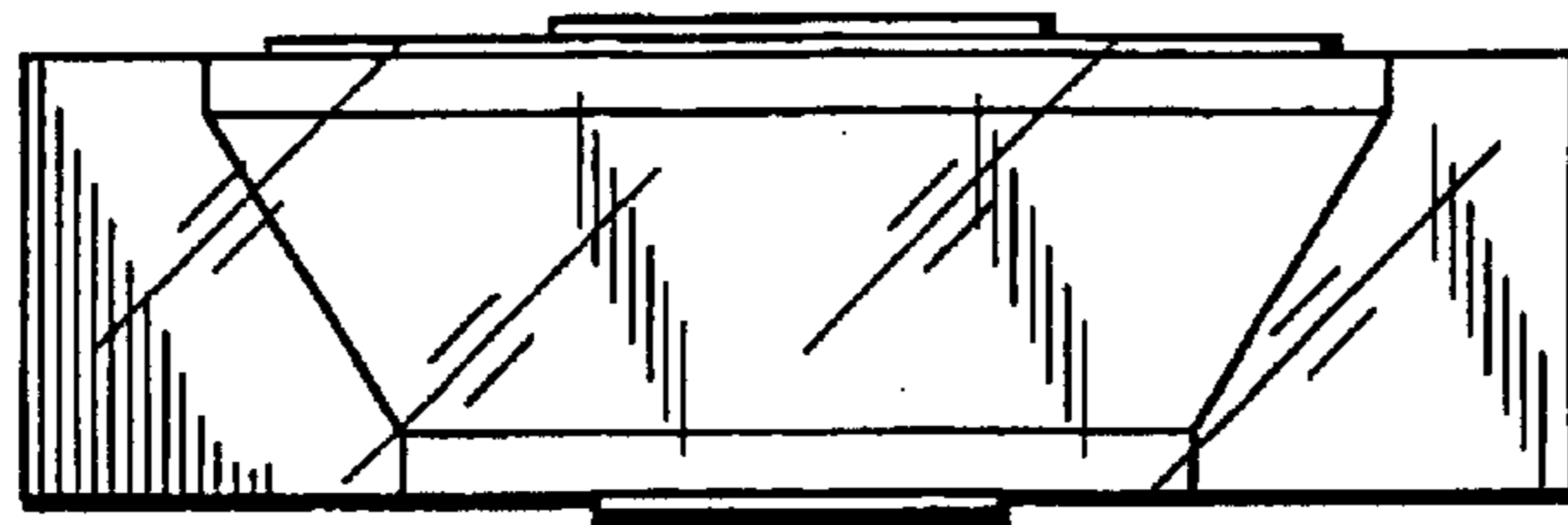

FIG. 1

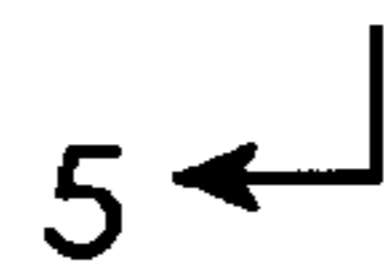
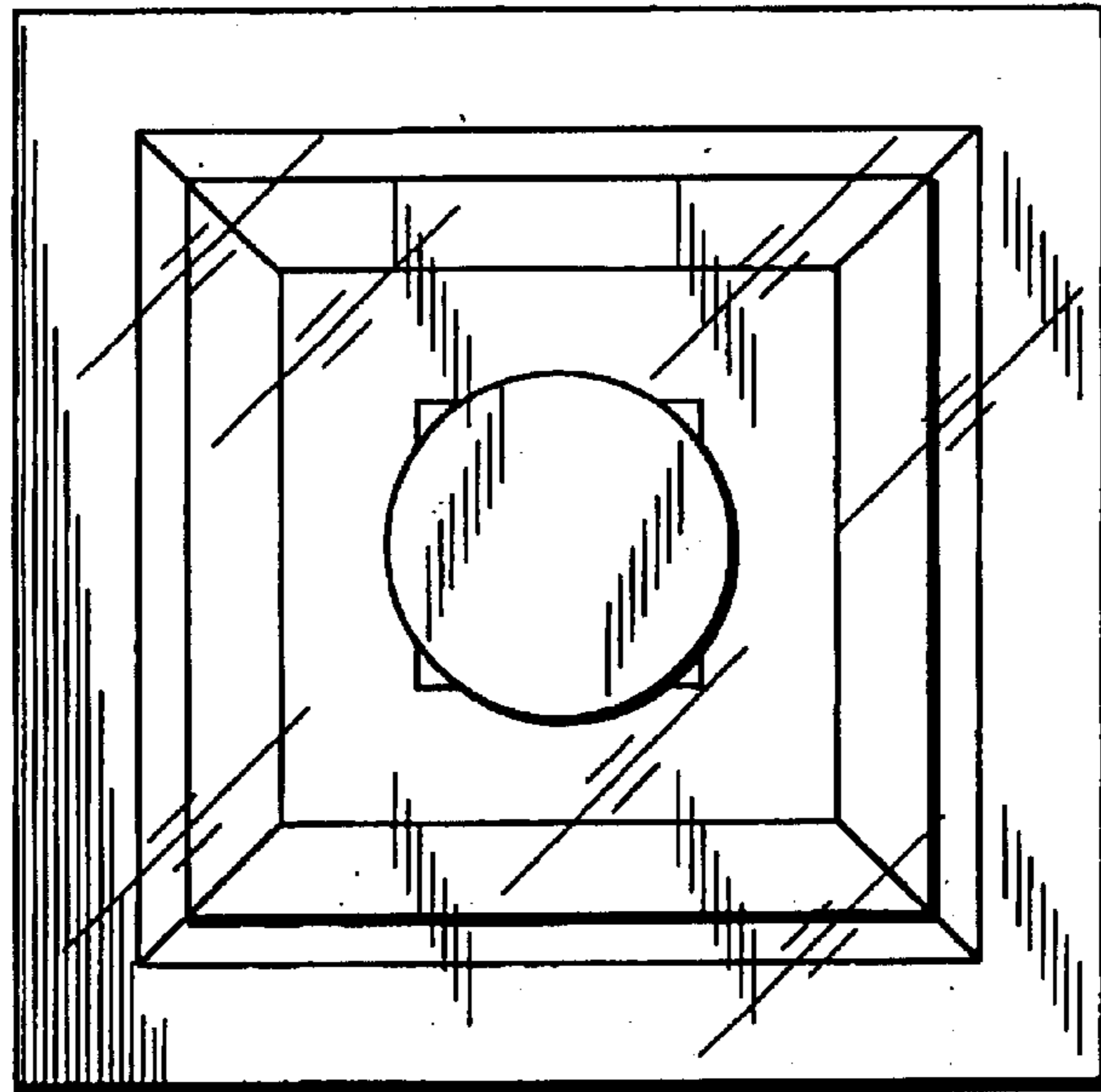
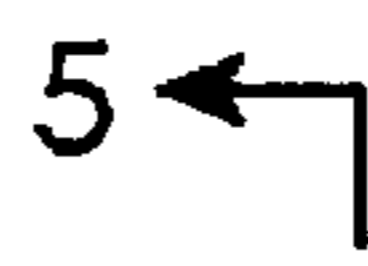

FIG. 2

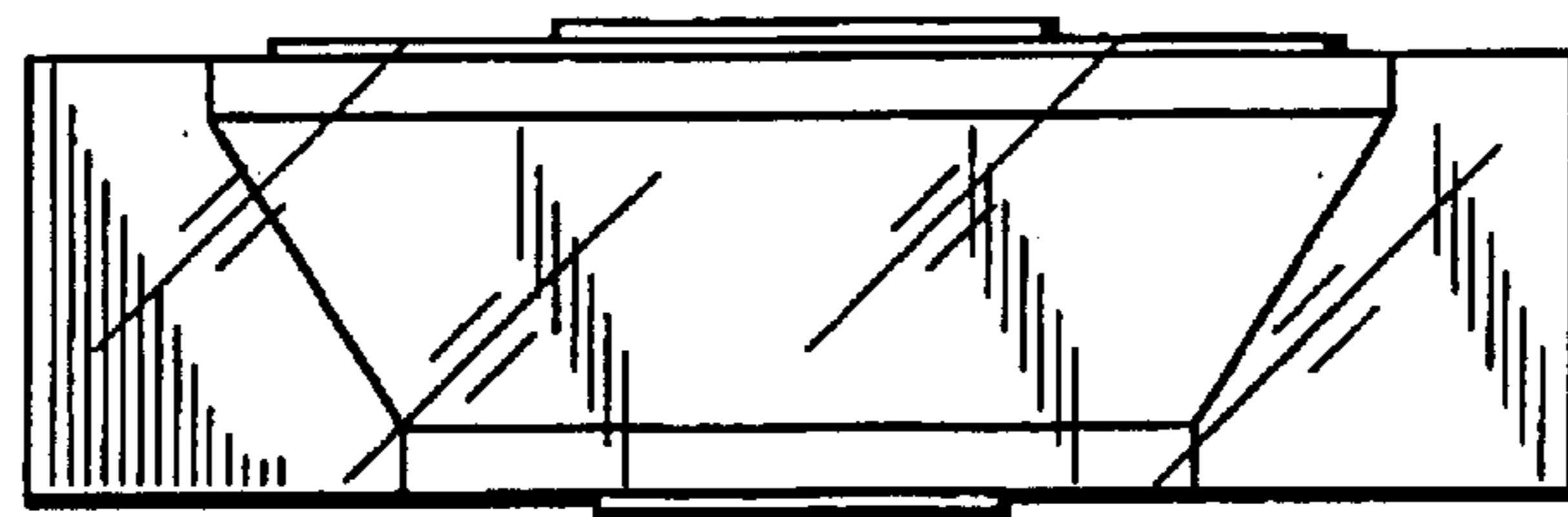

FIG. 3

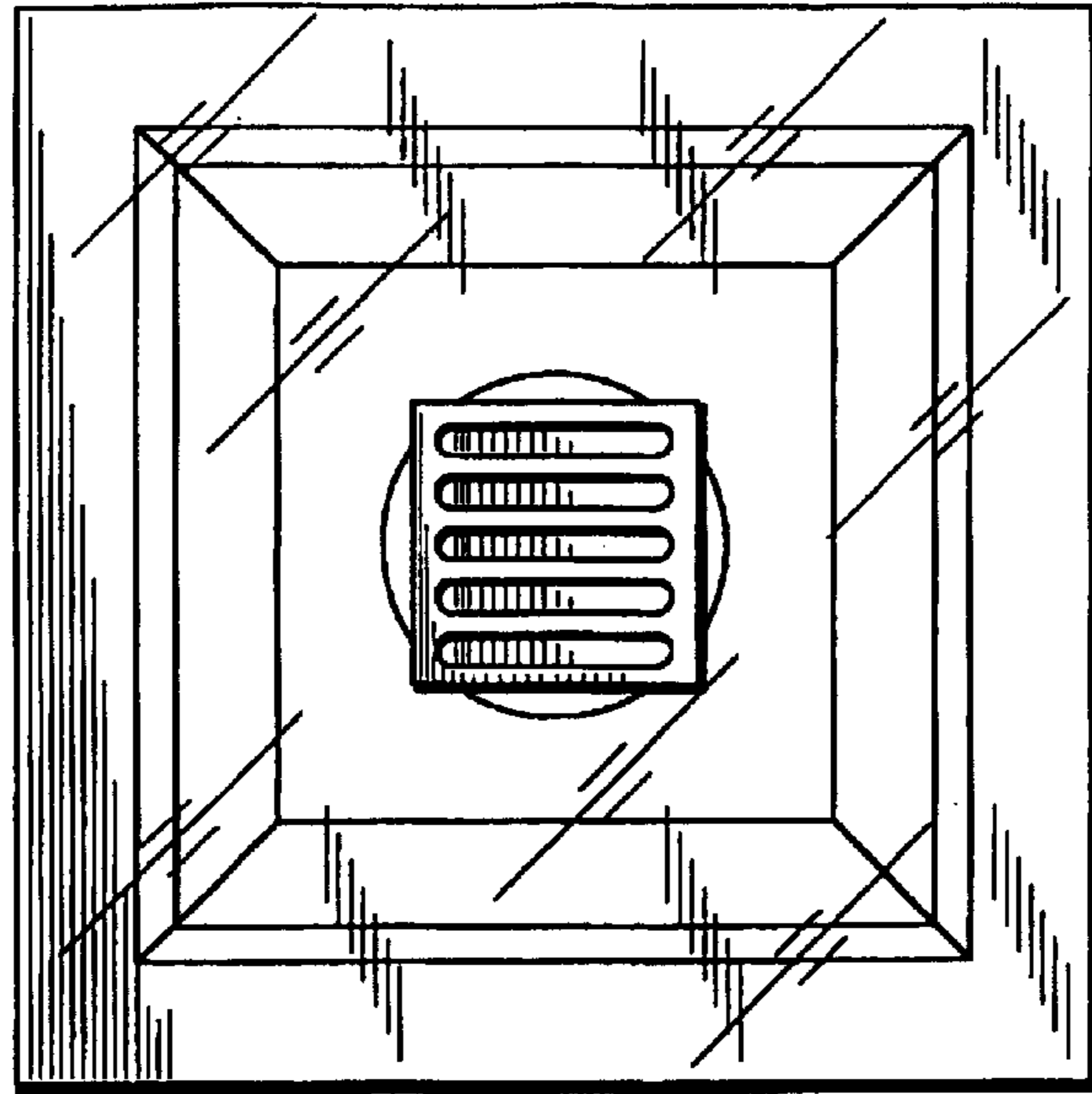

FIG. 4

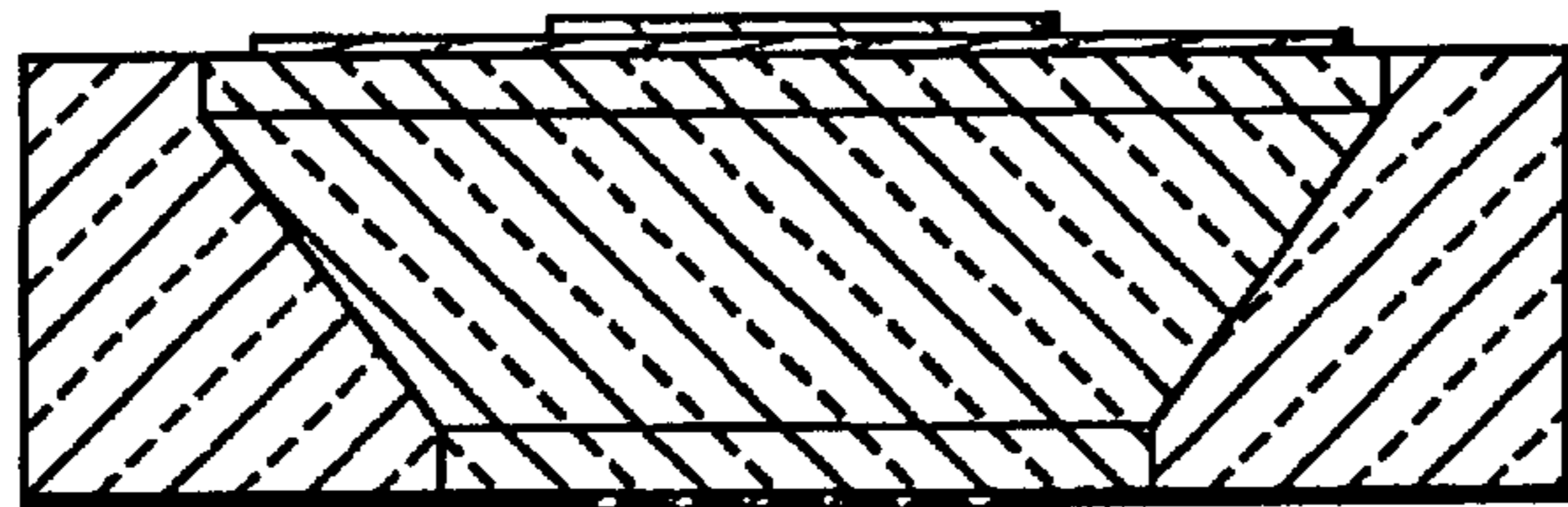

FIG. 5

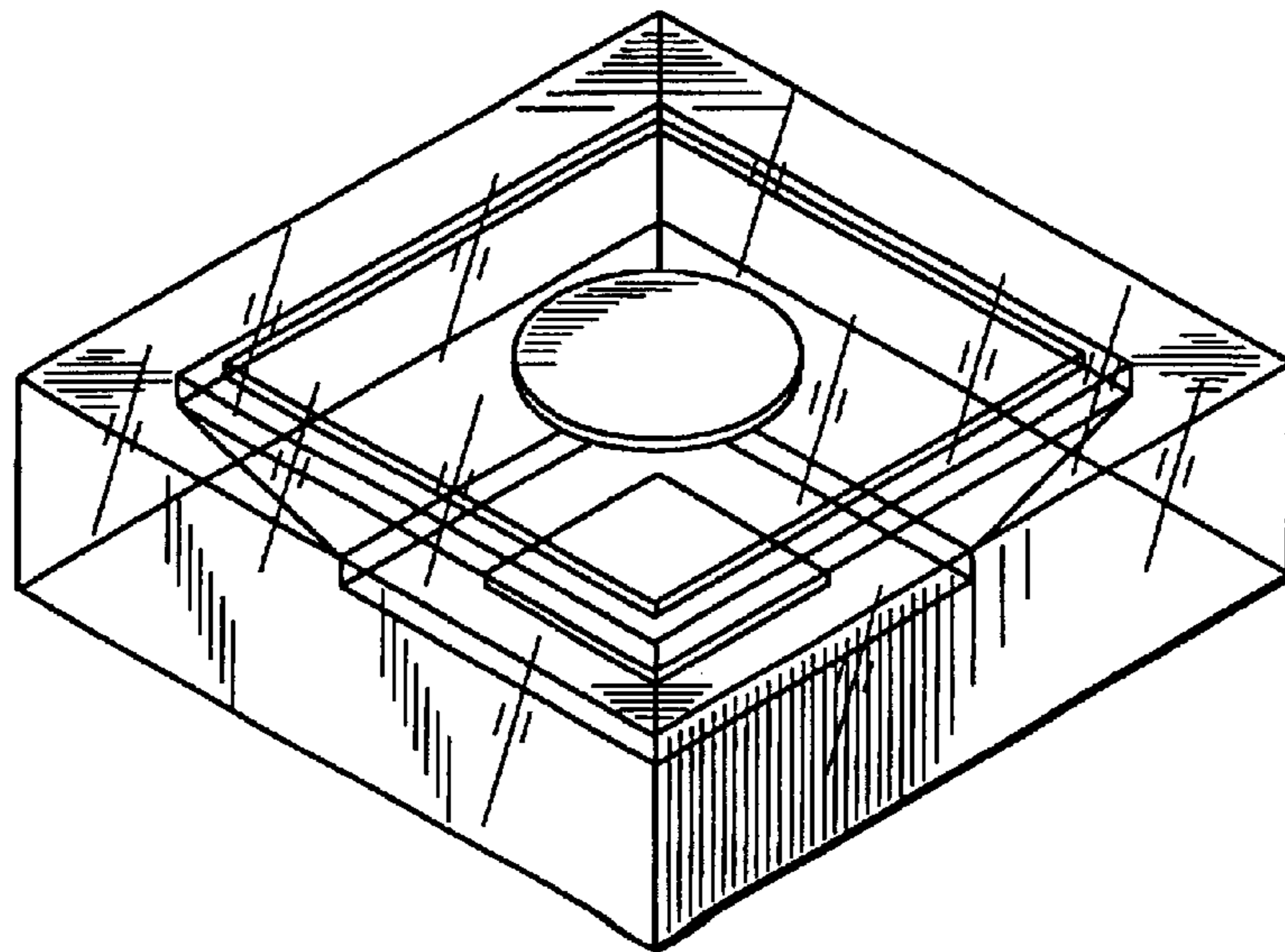

FIG. 6



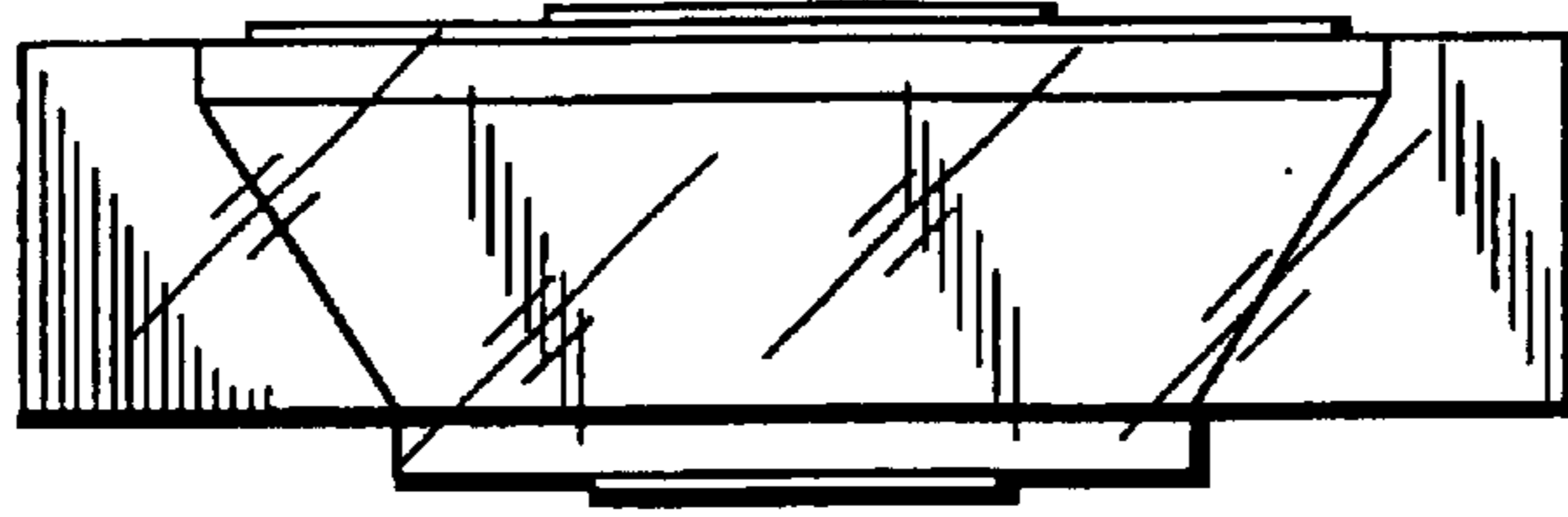

FIG. 7

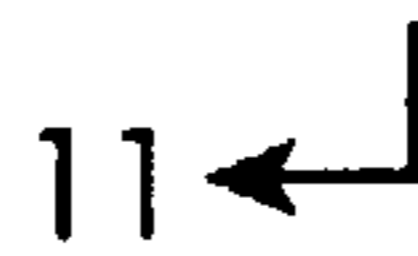
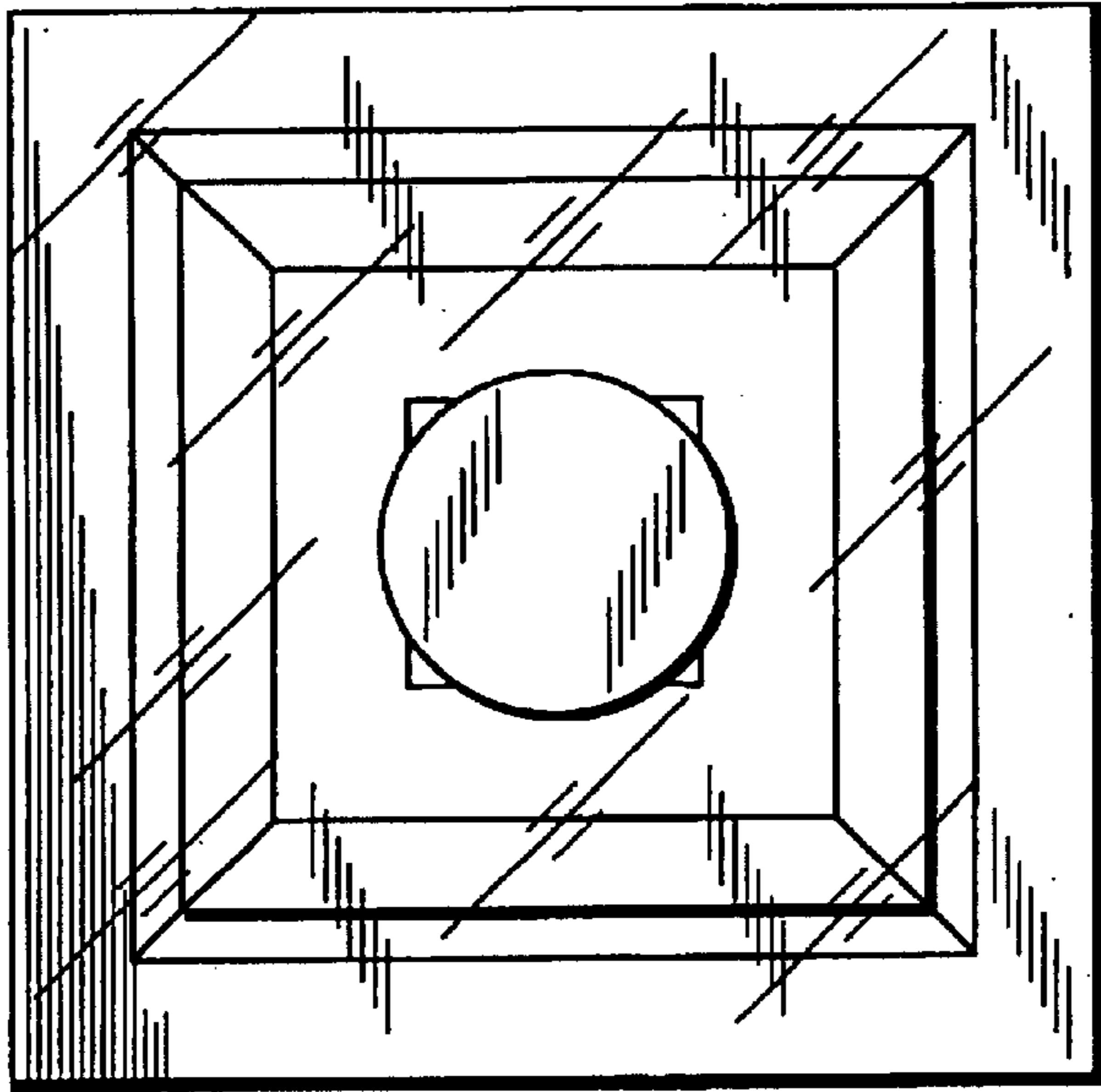
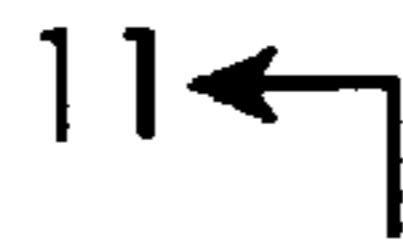

FIG. 8

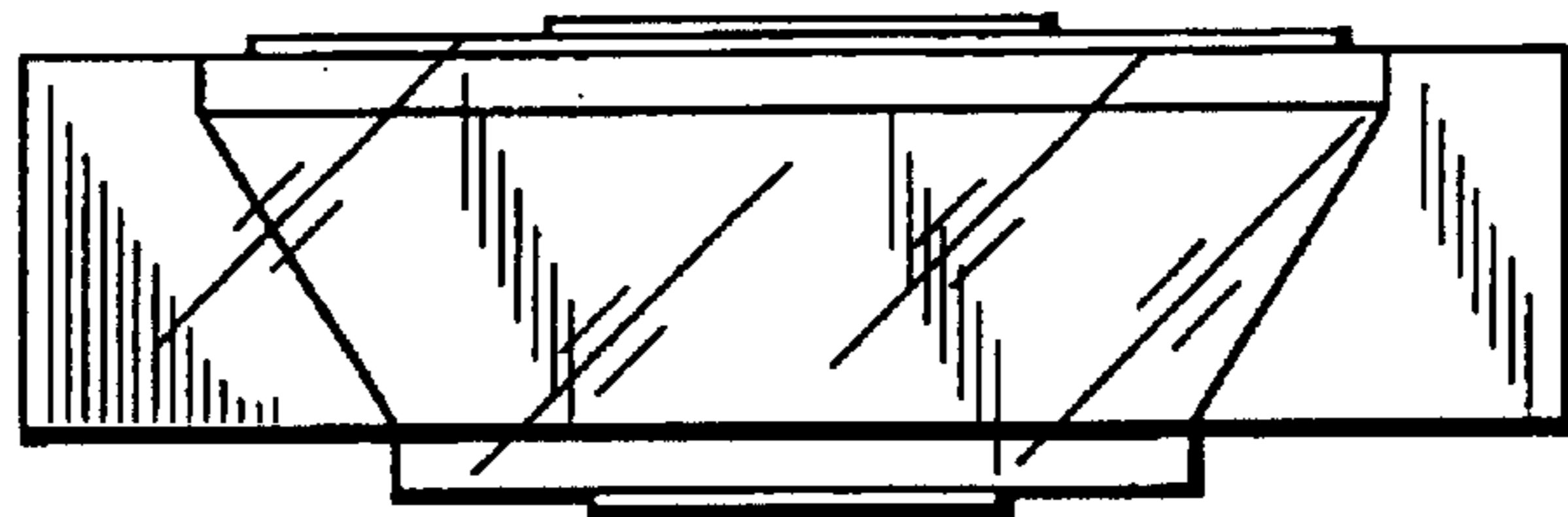

FIG. 9

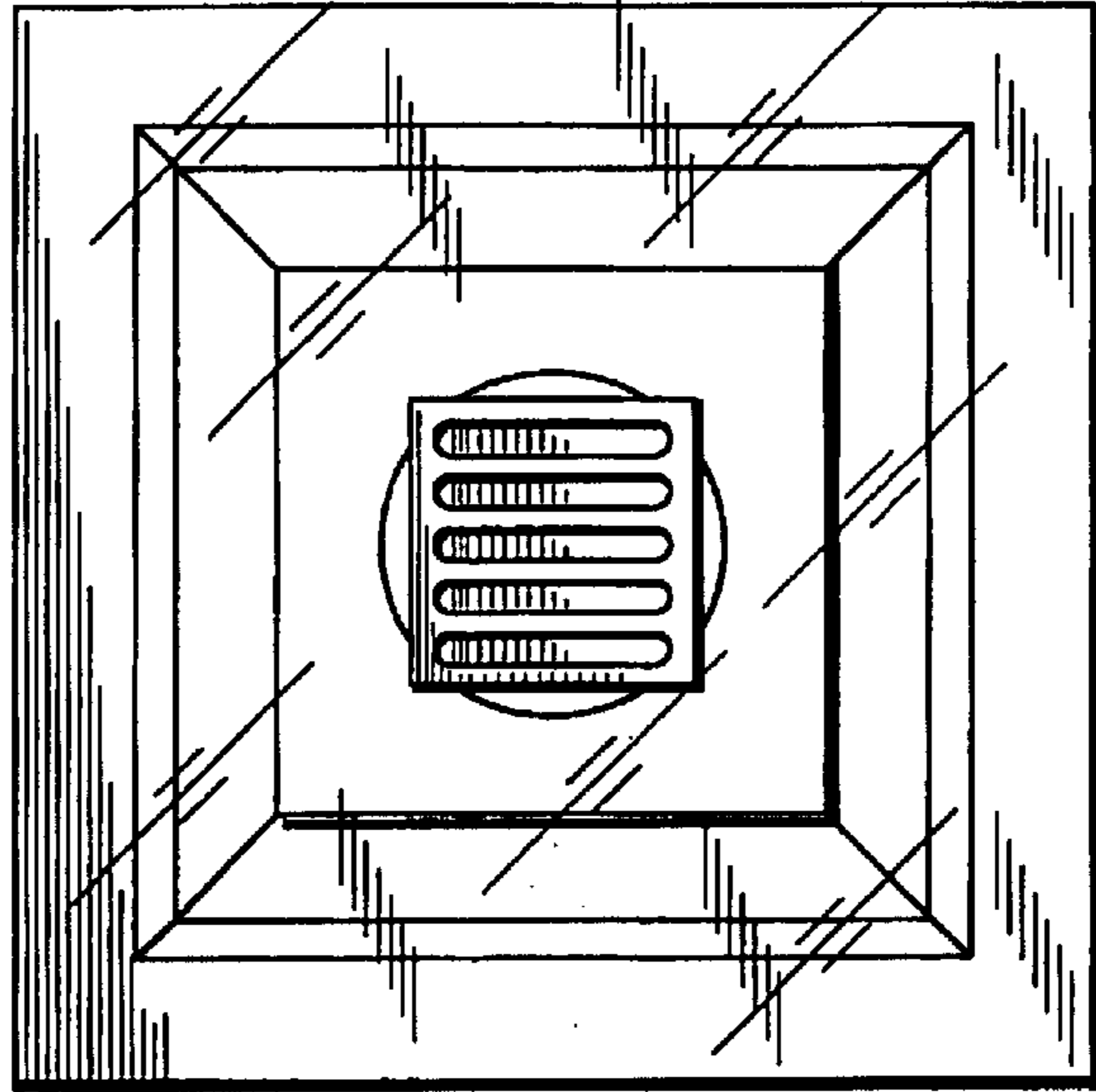

FIG. 10

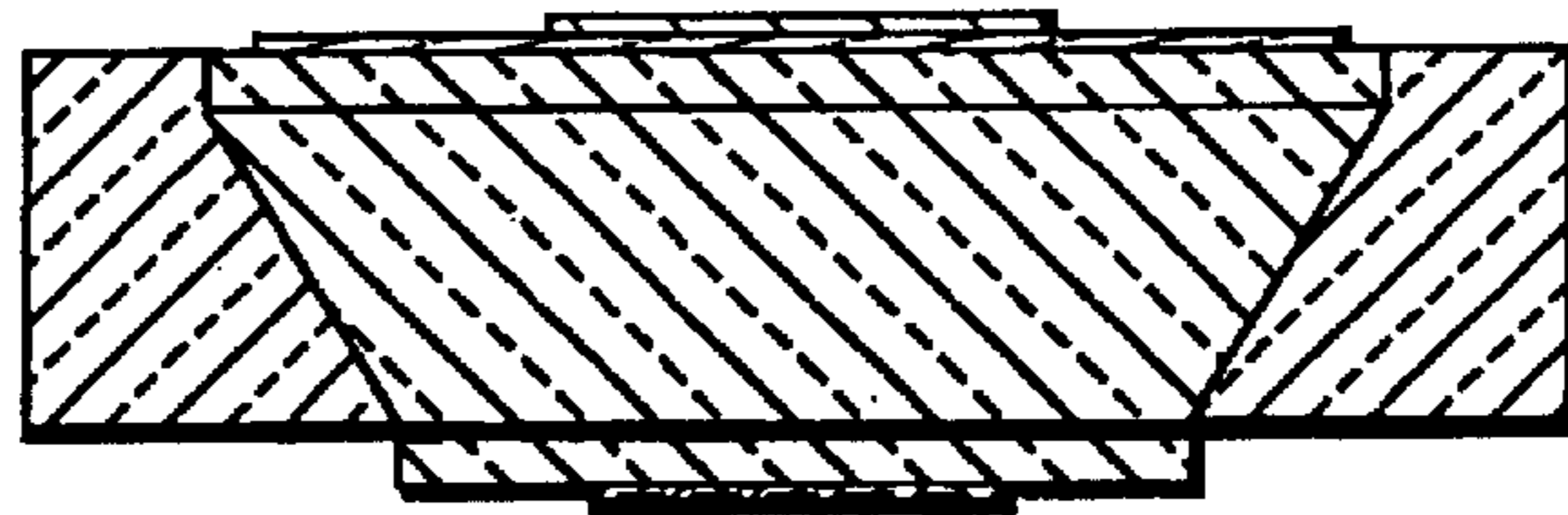

FIG. 11

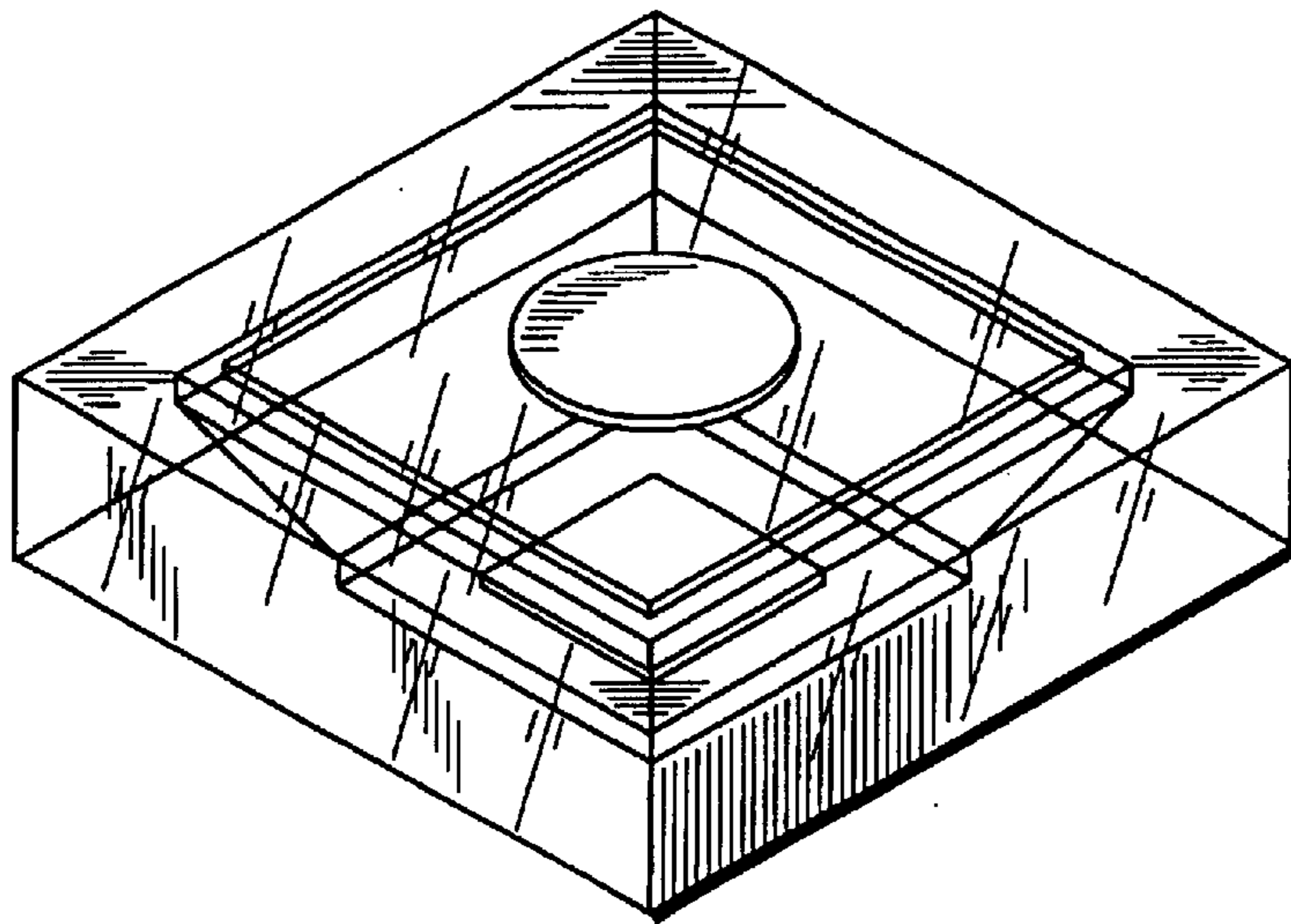

FIG. 12

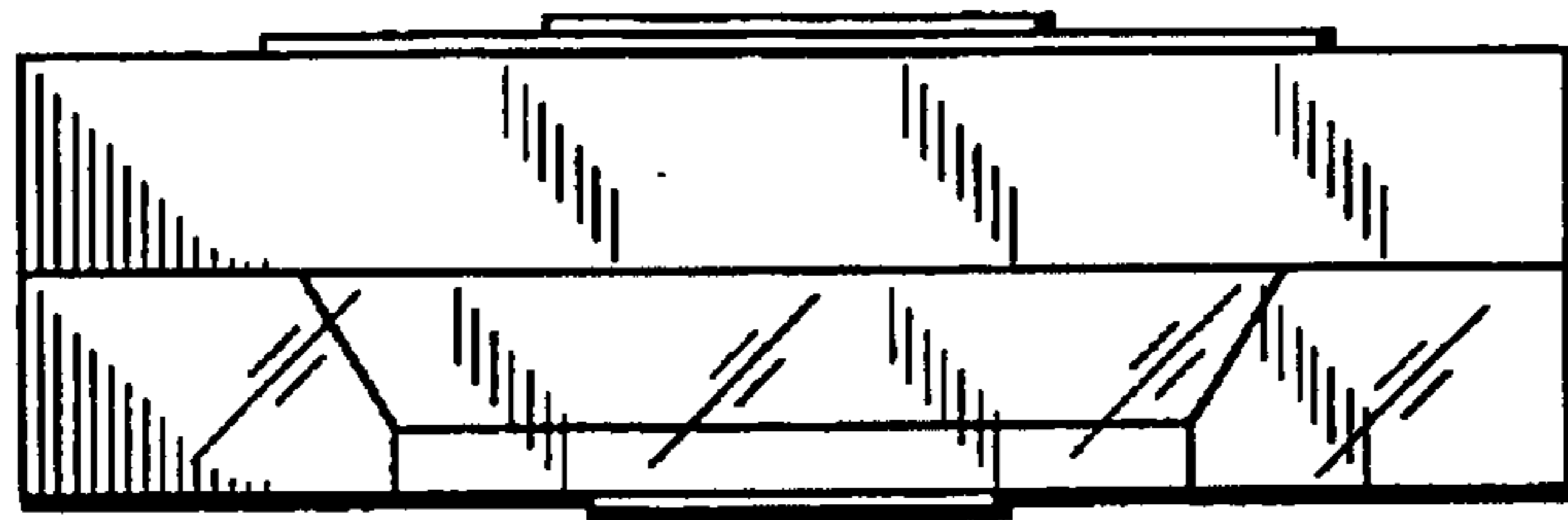
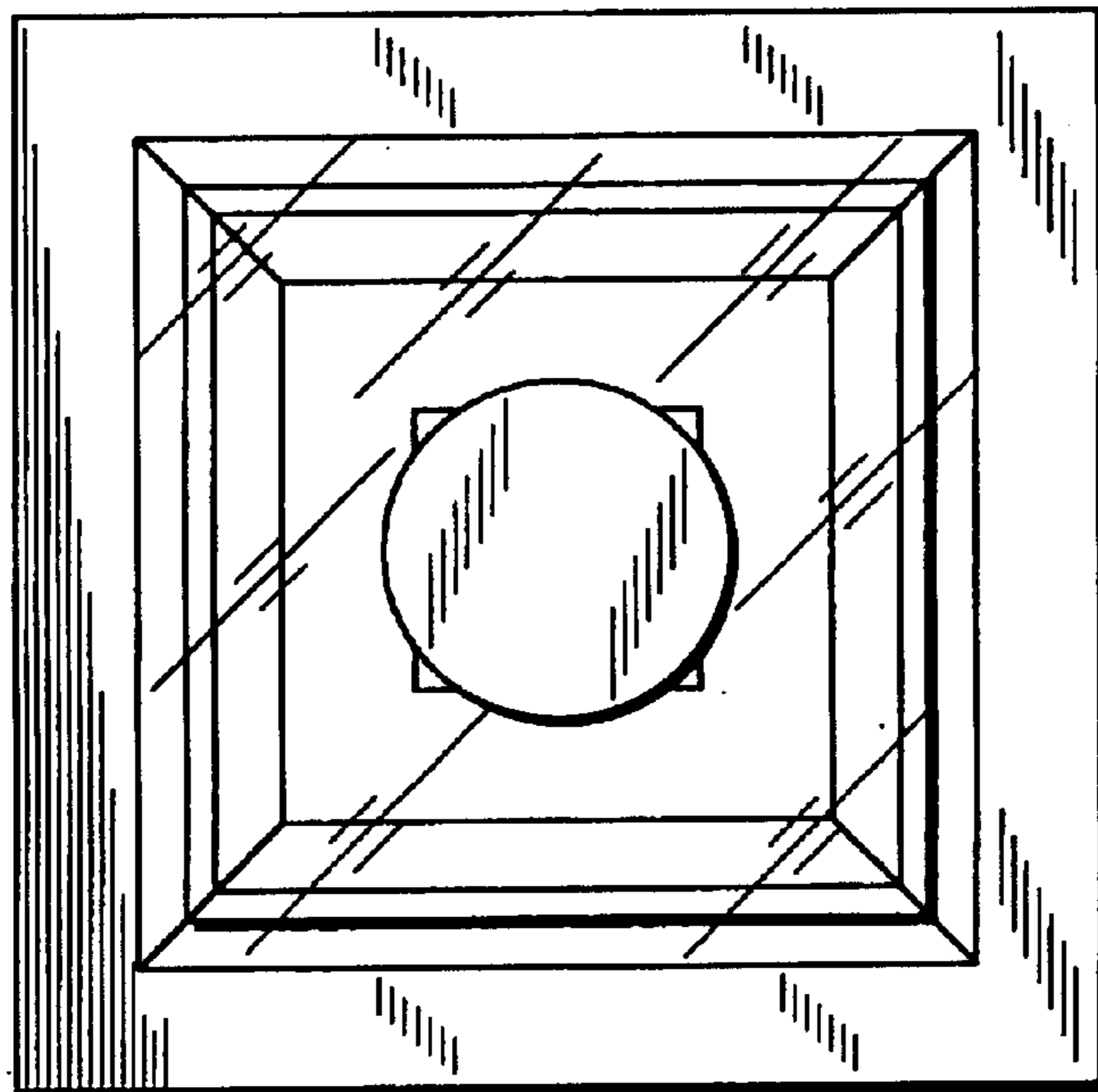

FIG. 13

17 ←



17 ←

FIG. 14

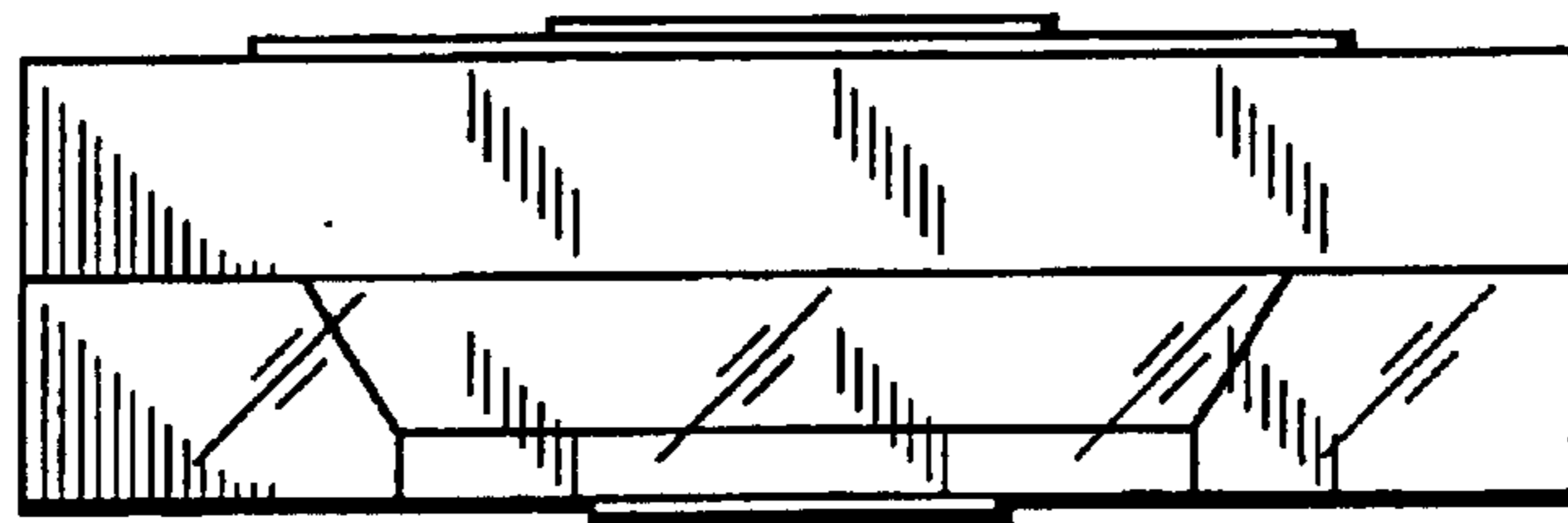

FIG. 15

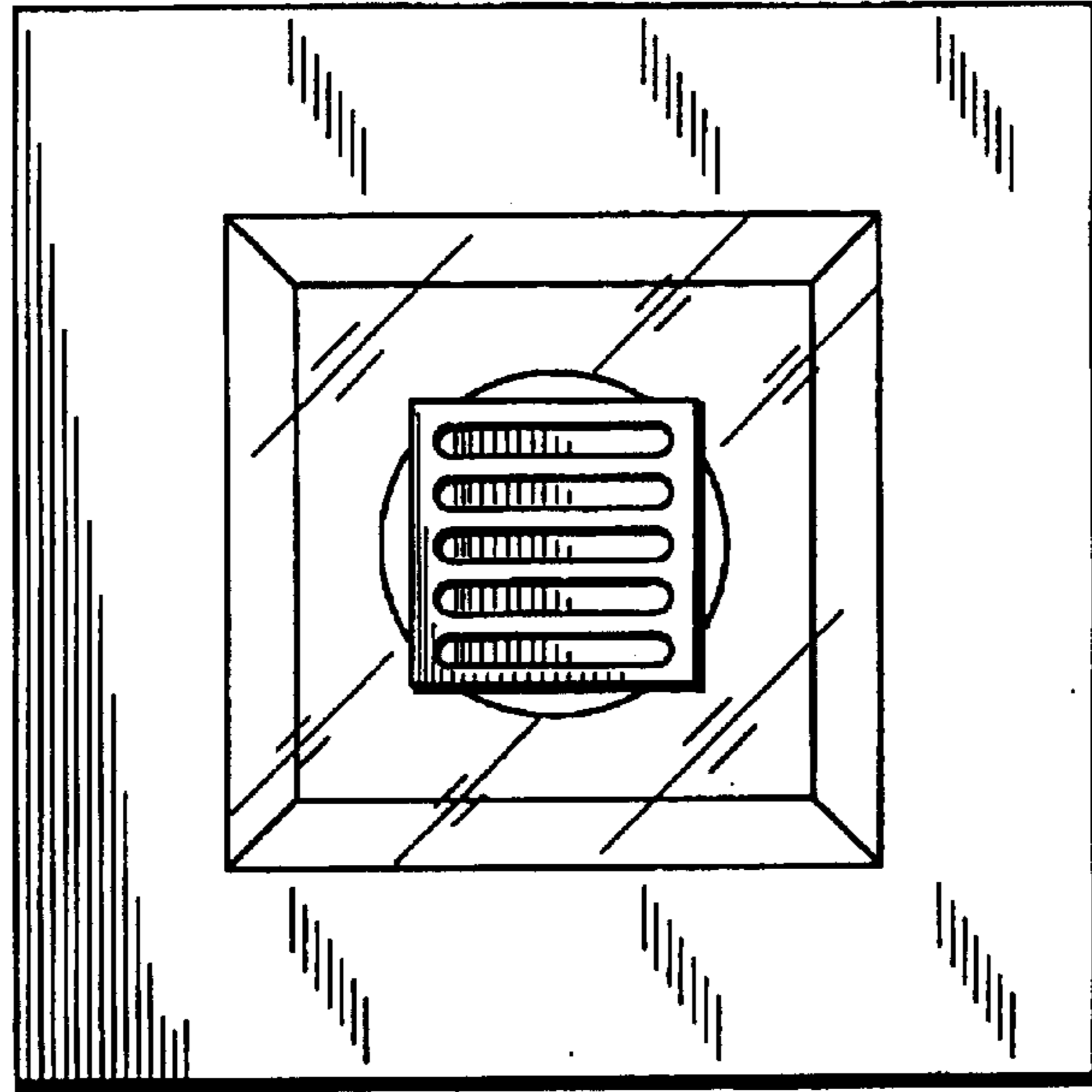

FIG. 16

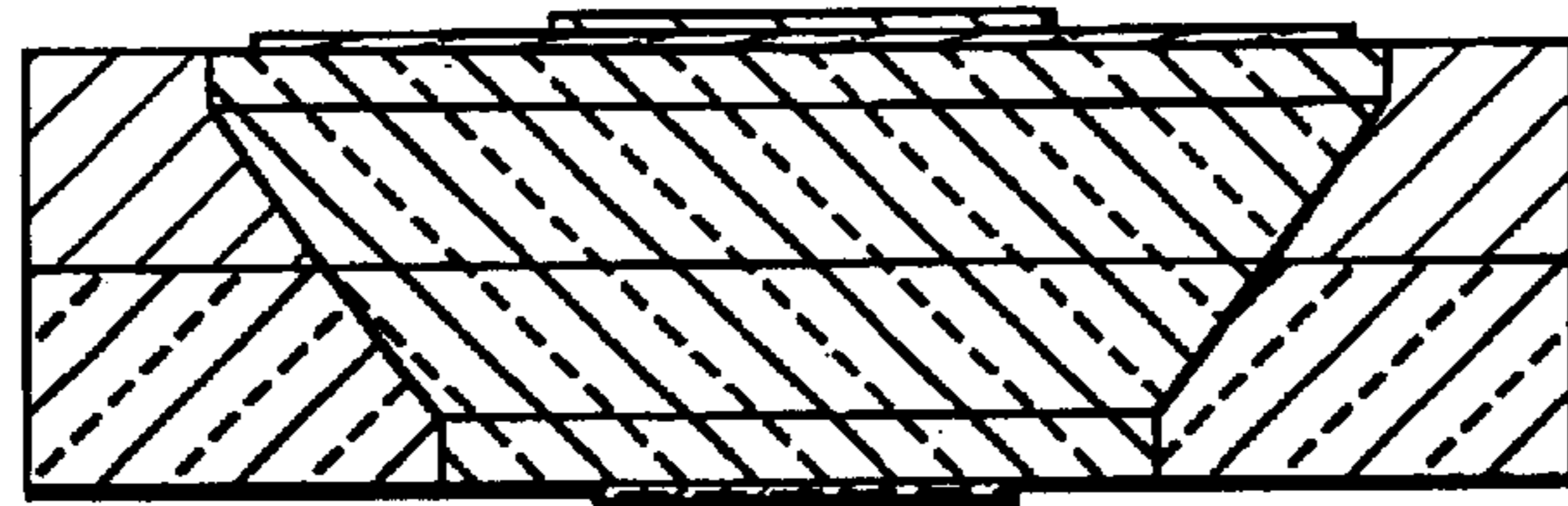

FIG. 17

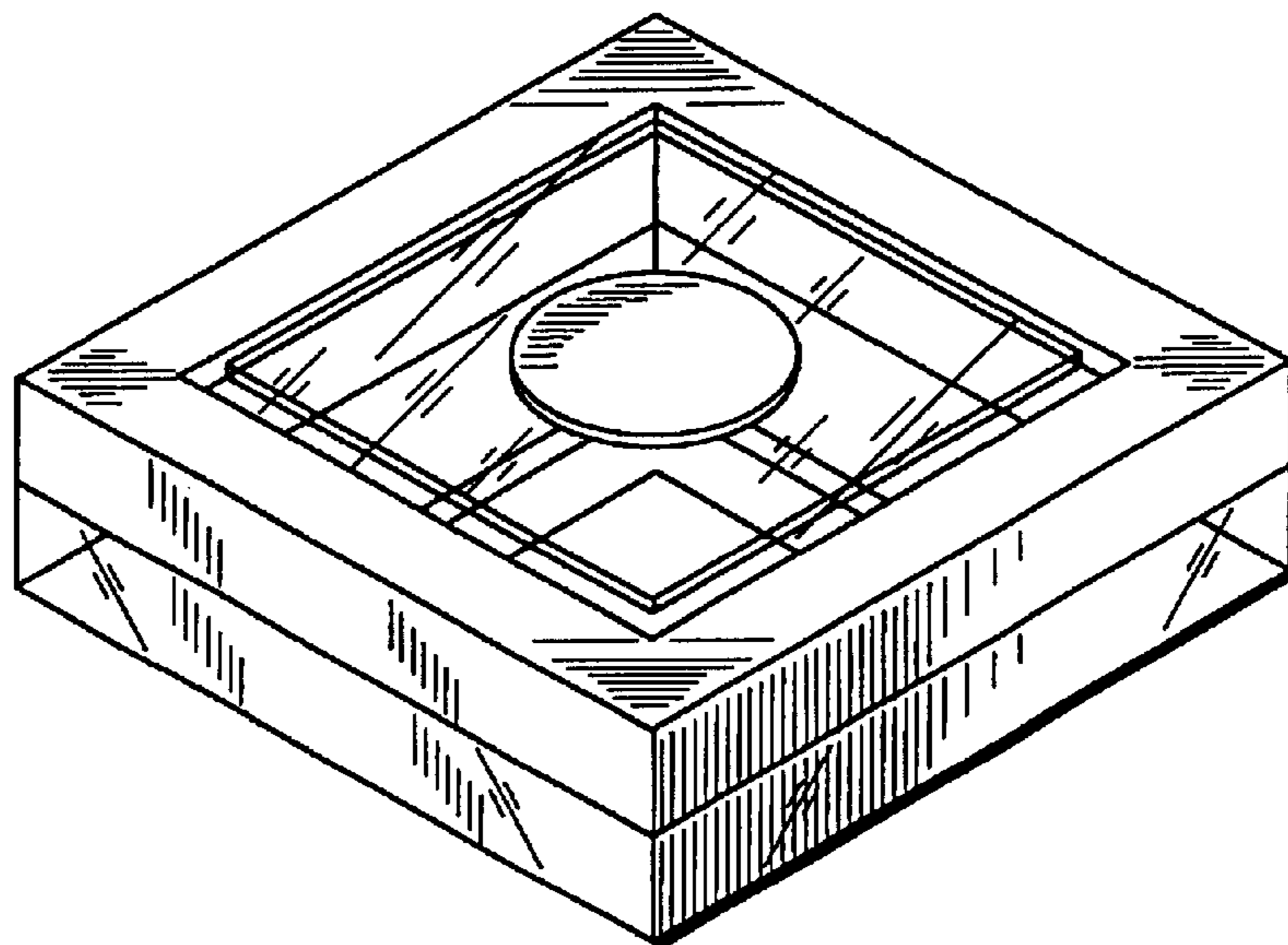

FIG. 18



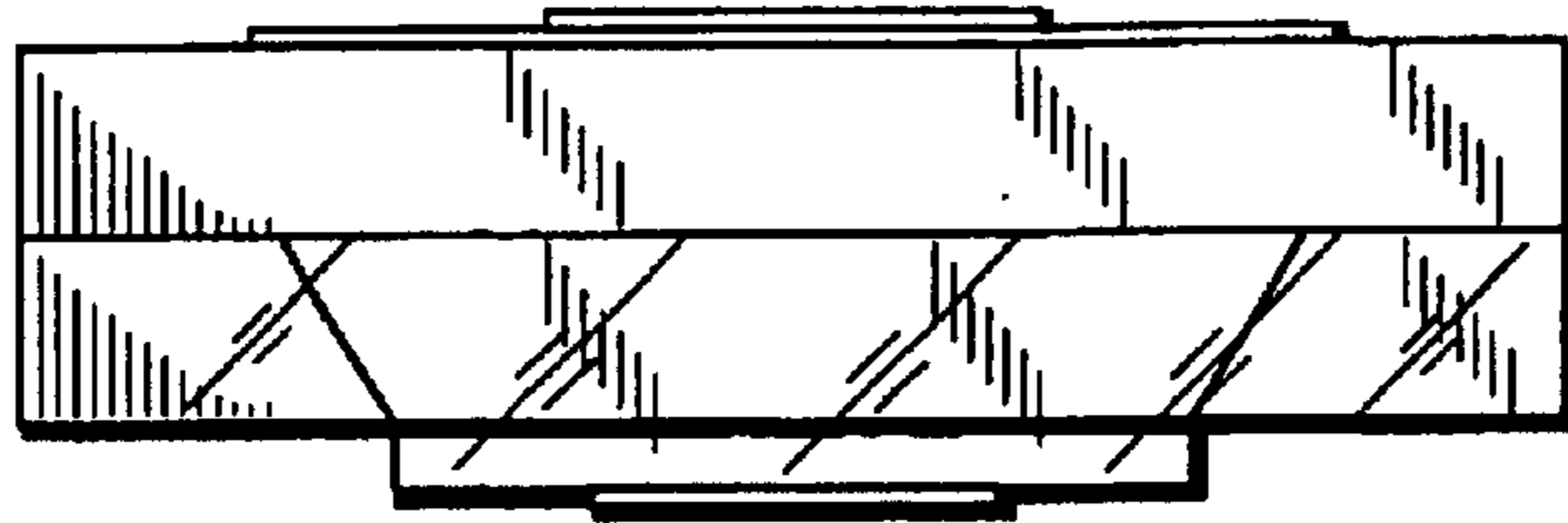

FIG.19

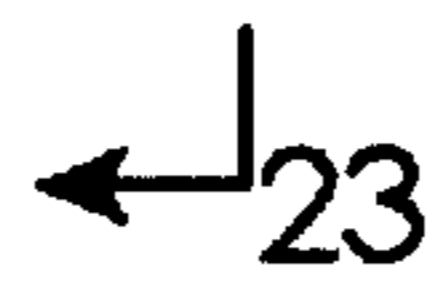
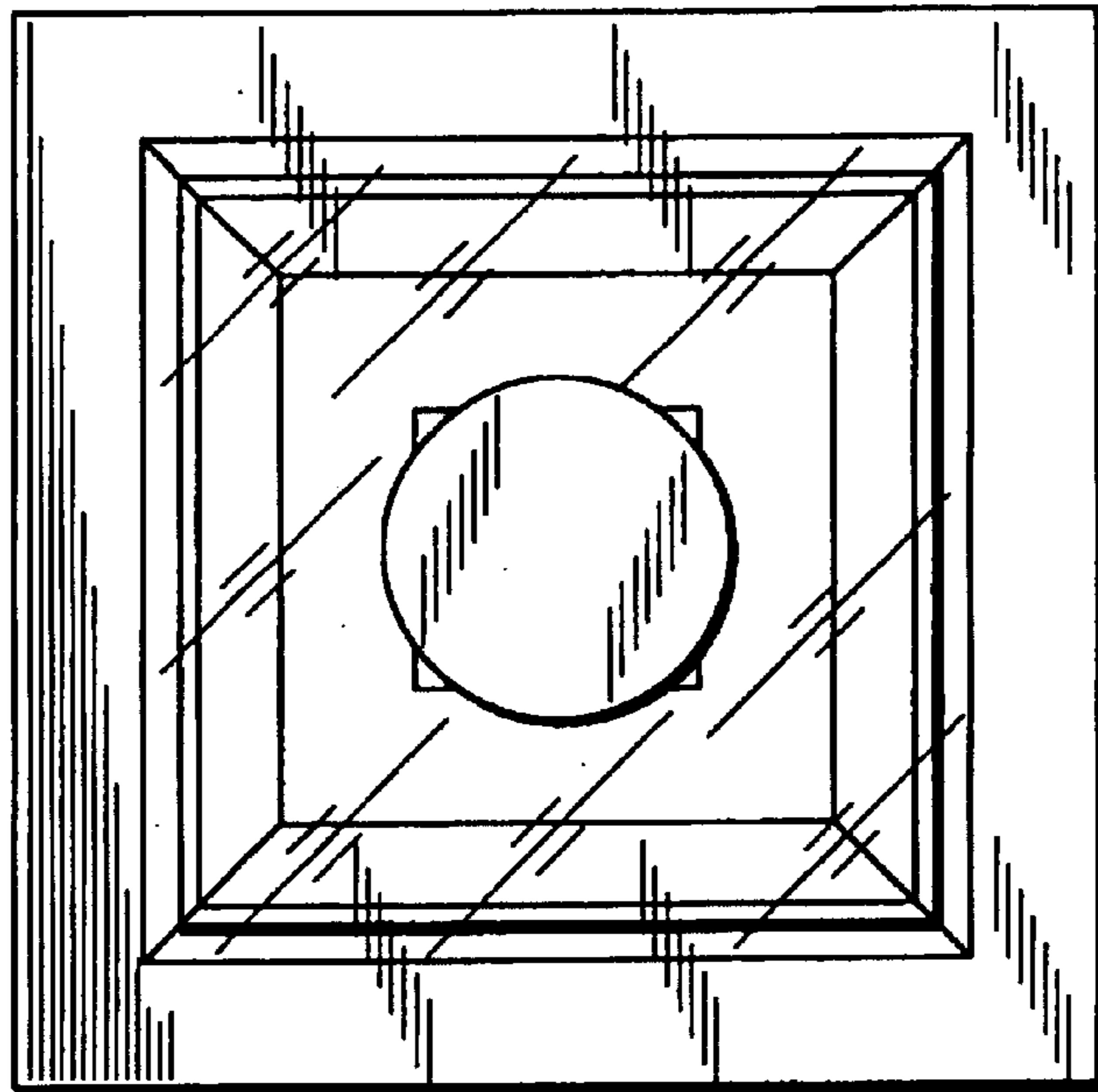
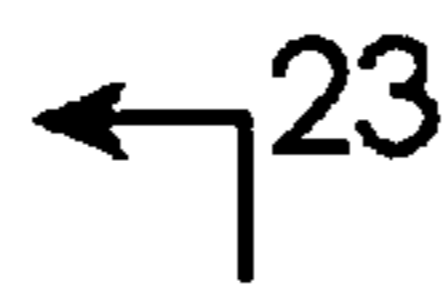

FIG.20

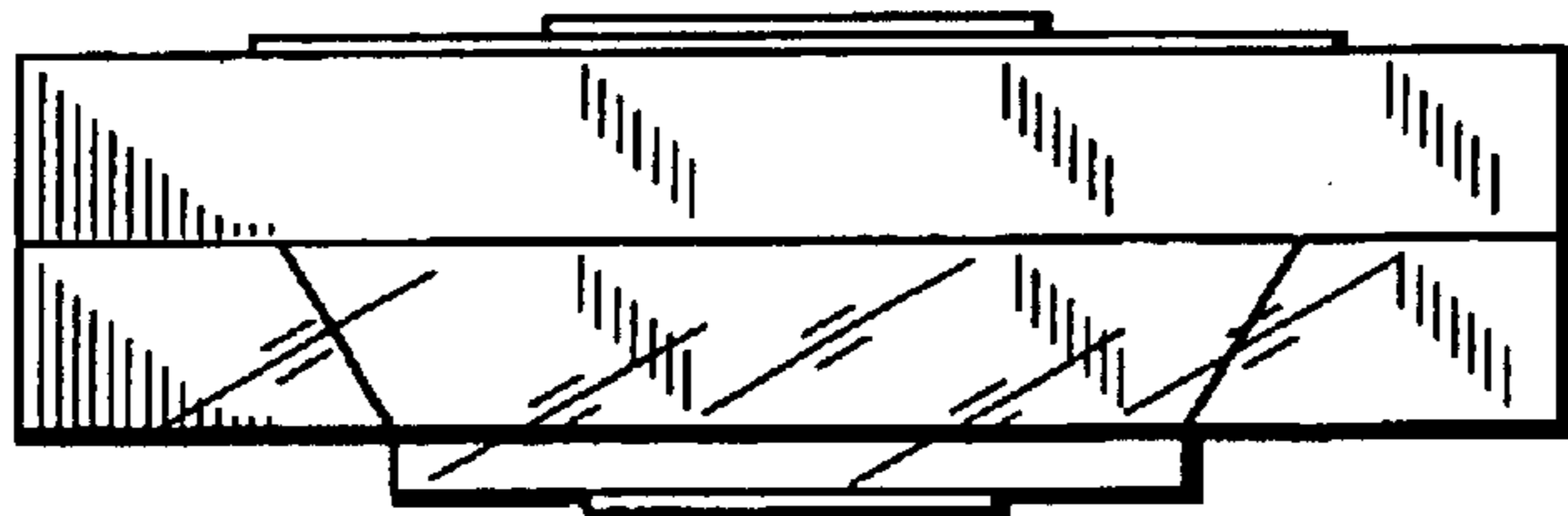

FIG.21

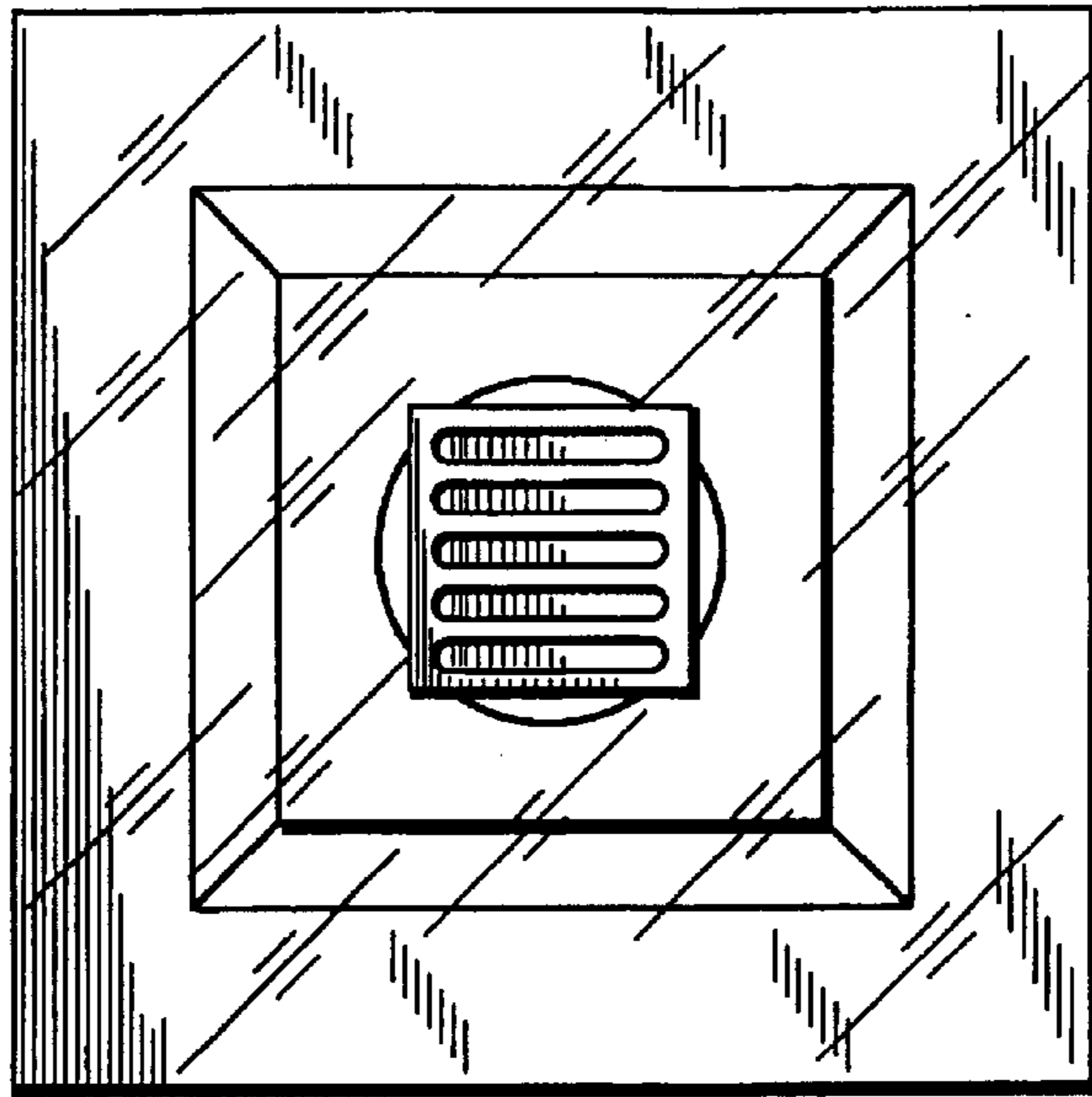

FIG. 22

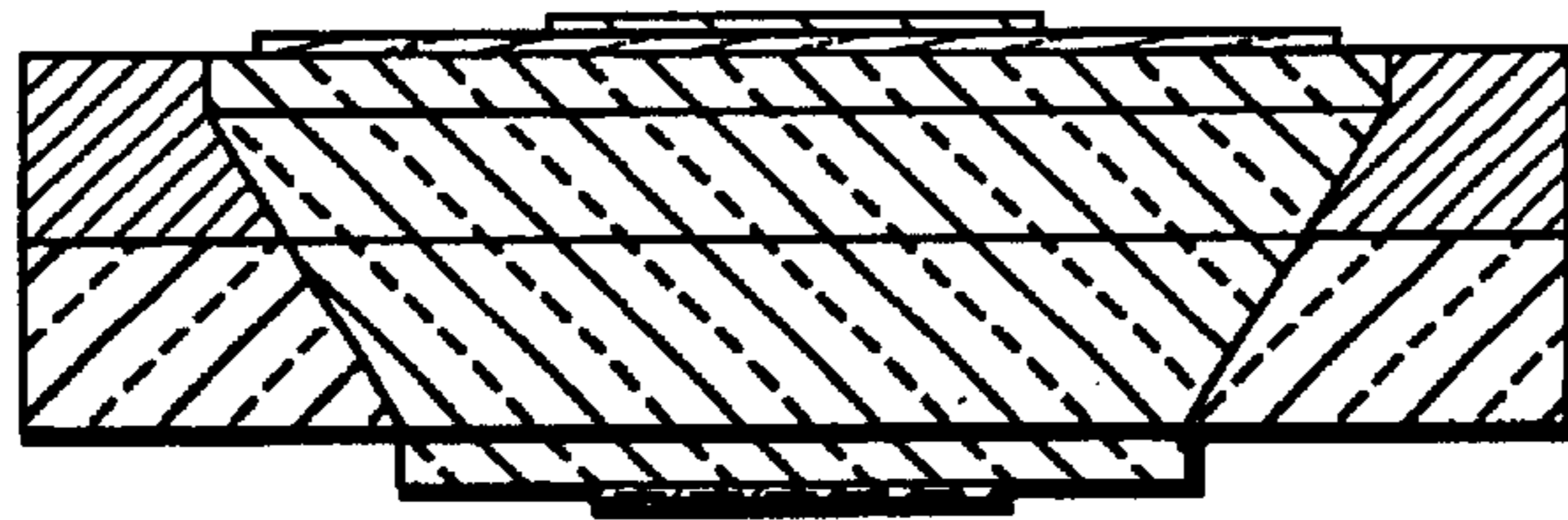

FIG. 23

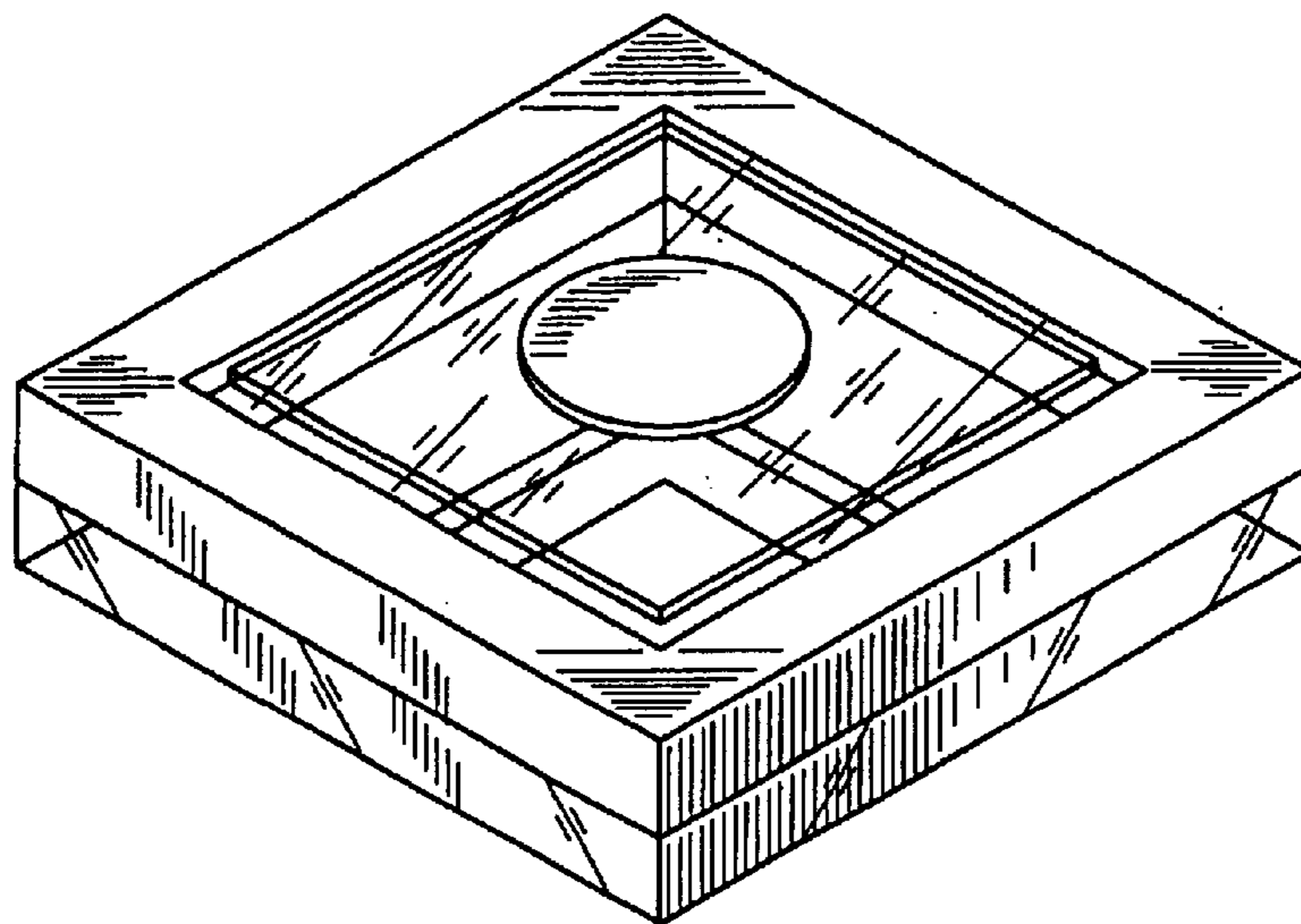

FIG. 24

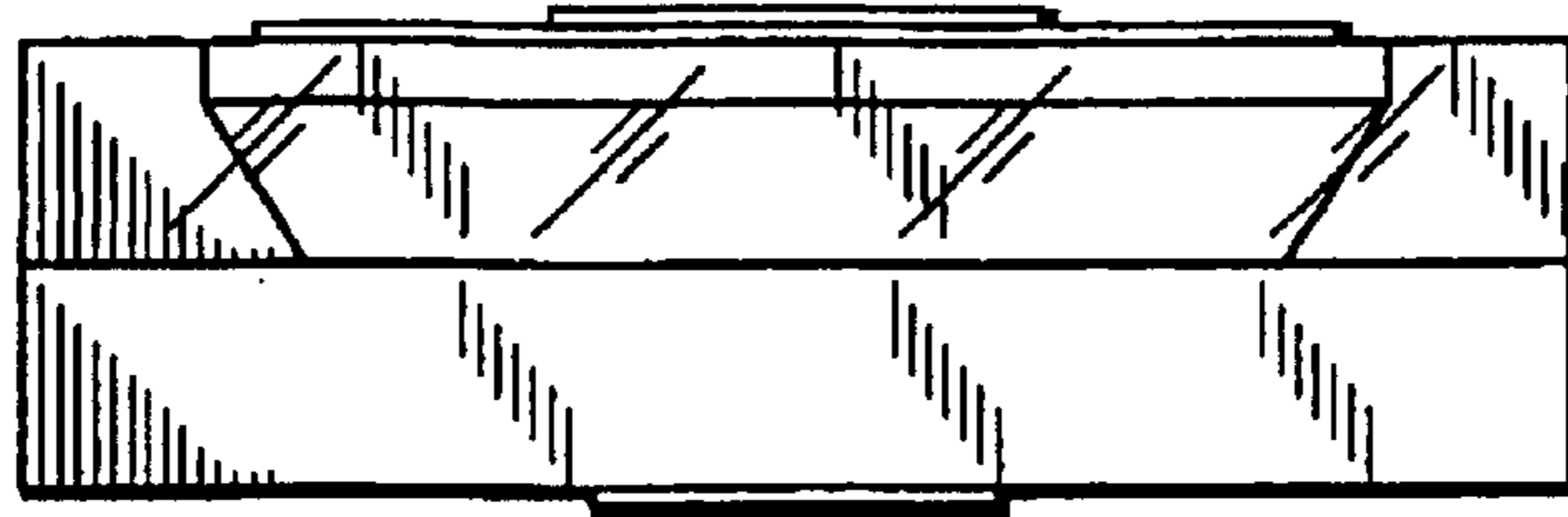
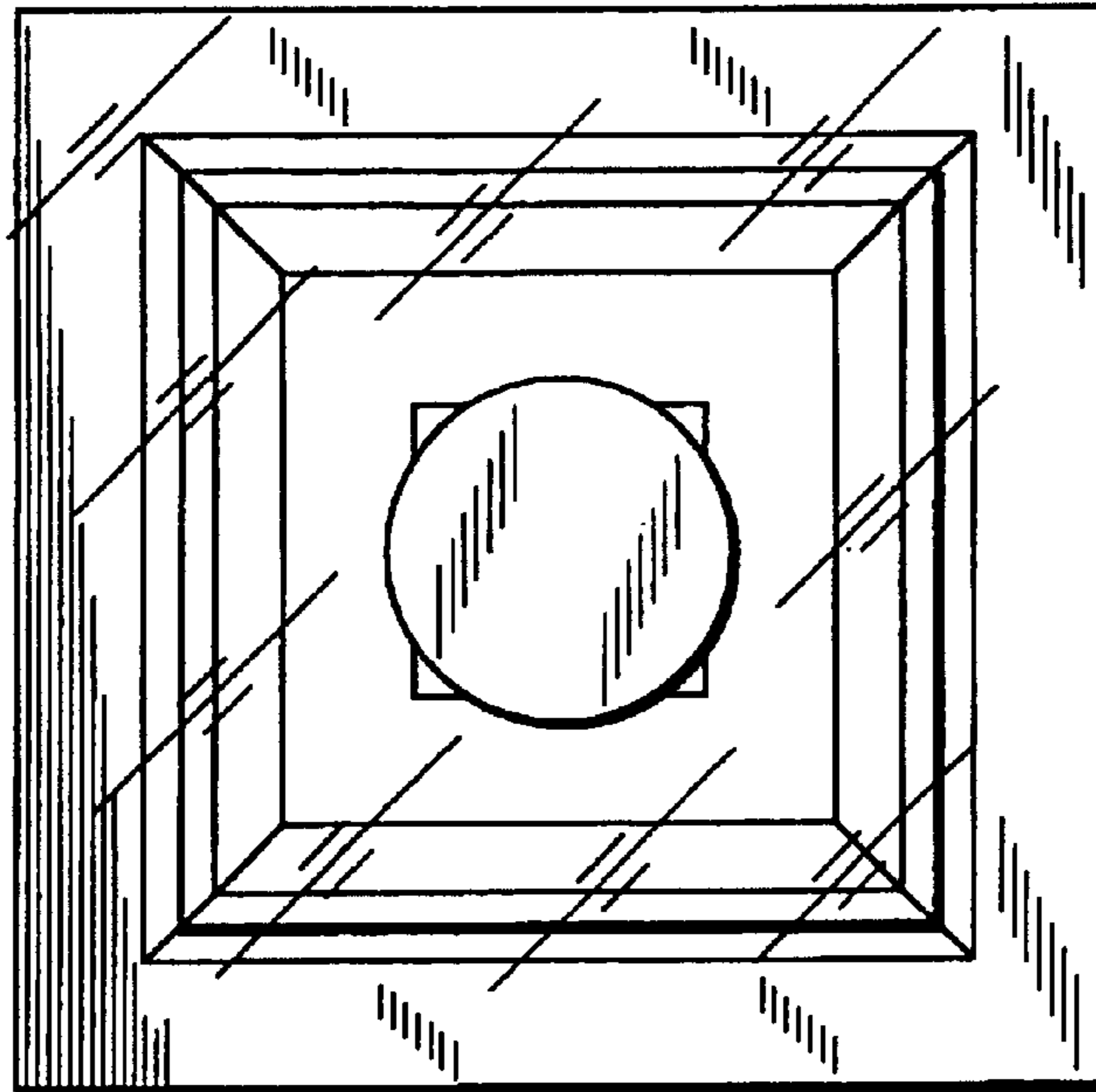

FIG. 25

29 ←



29 ←

FIG. 26

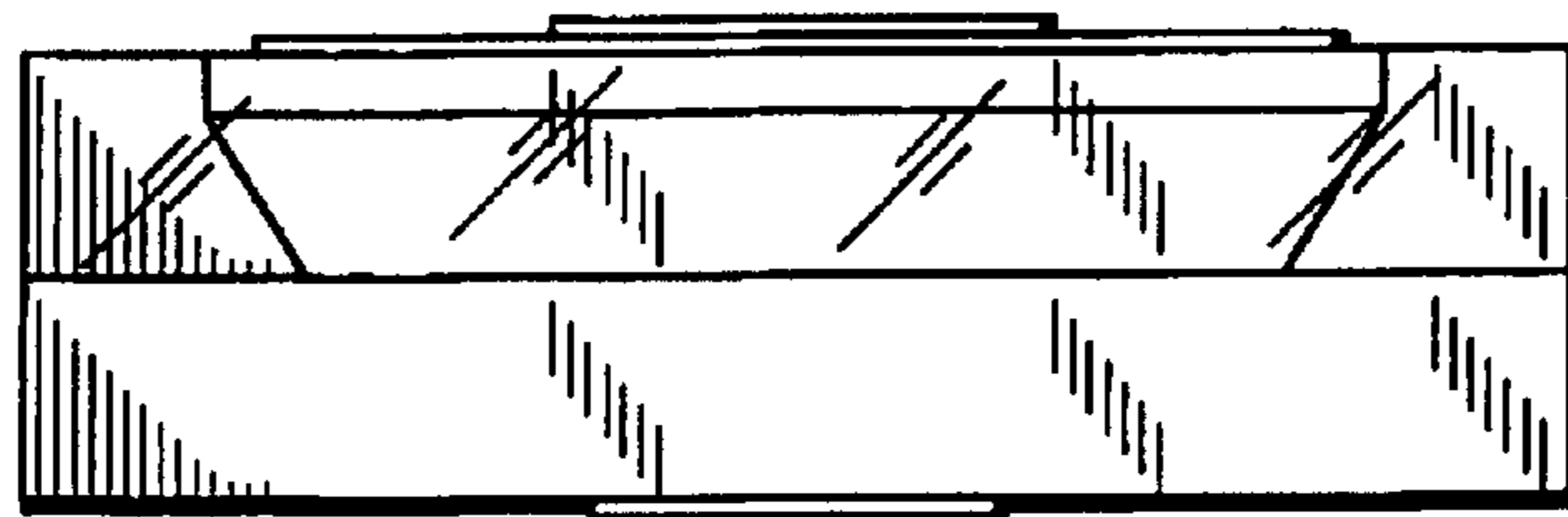

FIG. 27

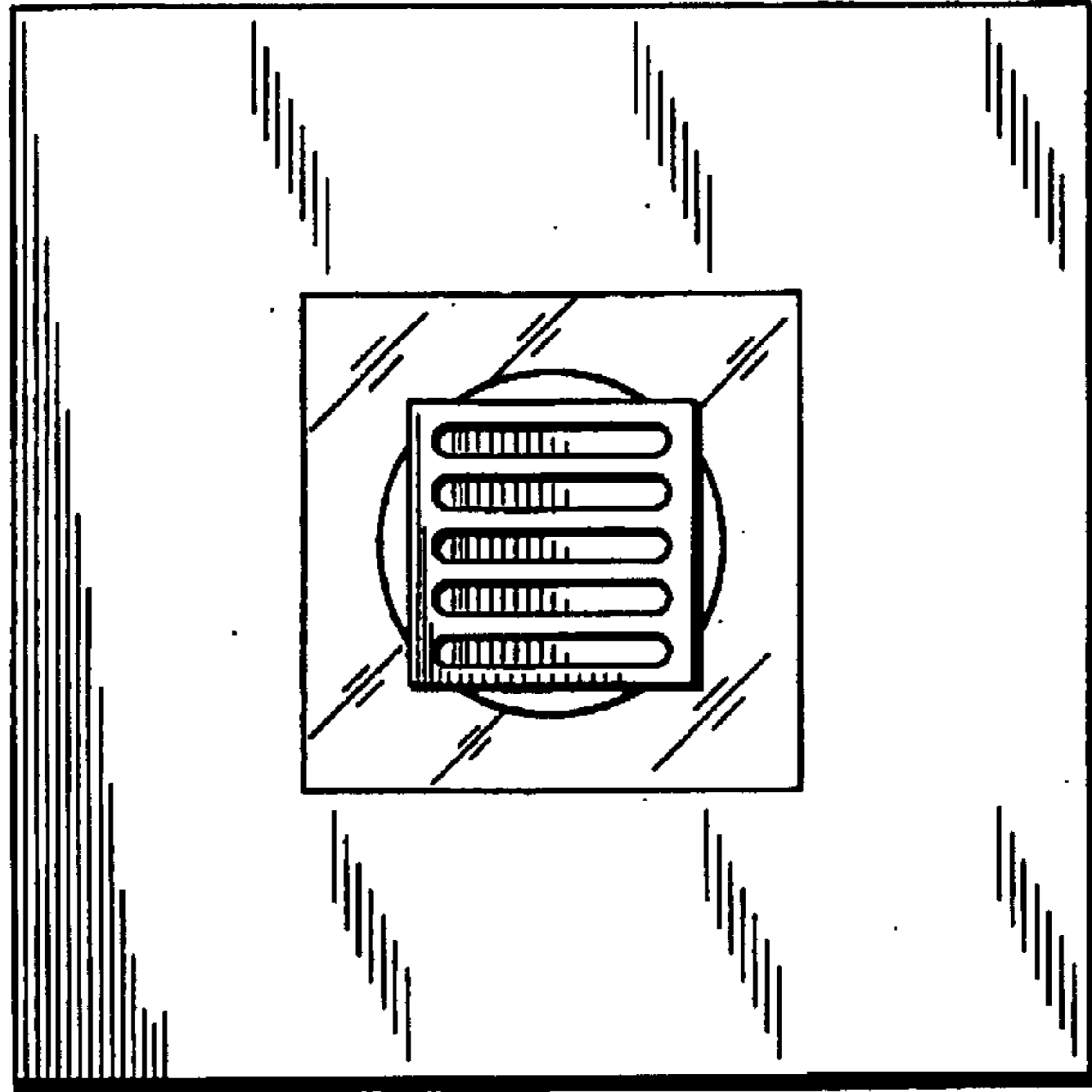

FIG. 28

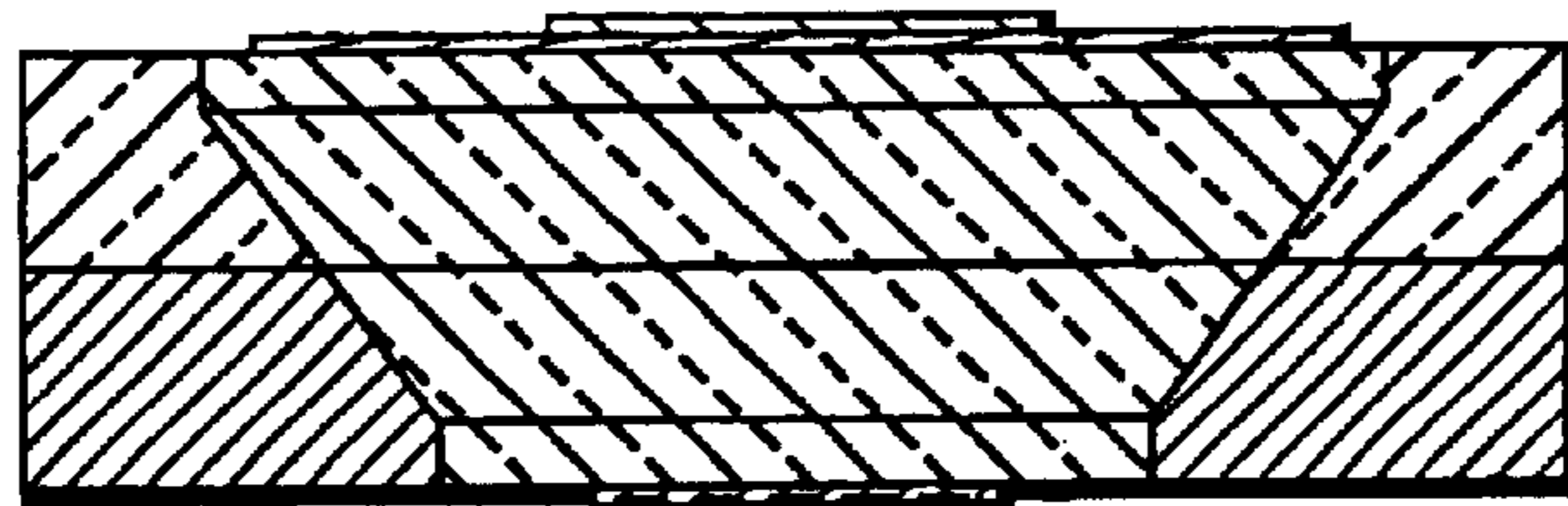

FIG. 29

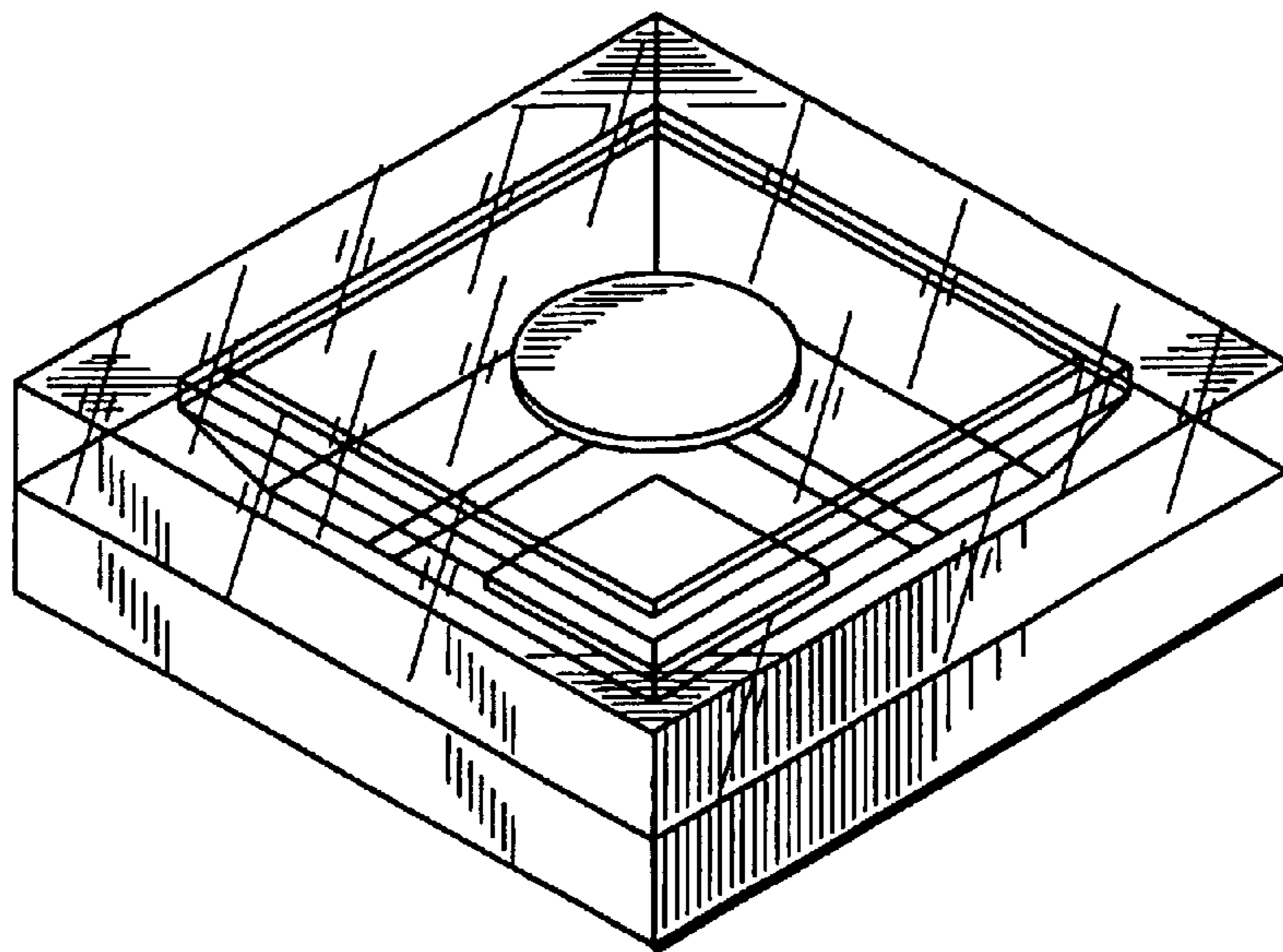

FIG. 30

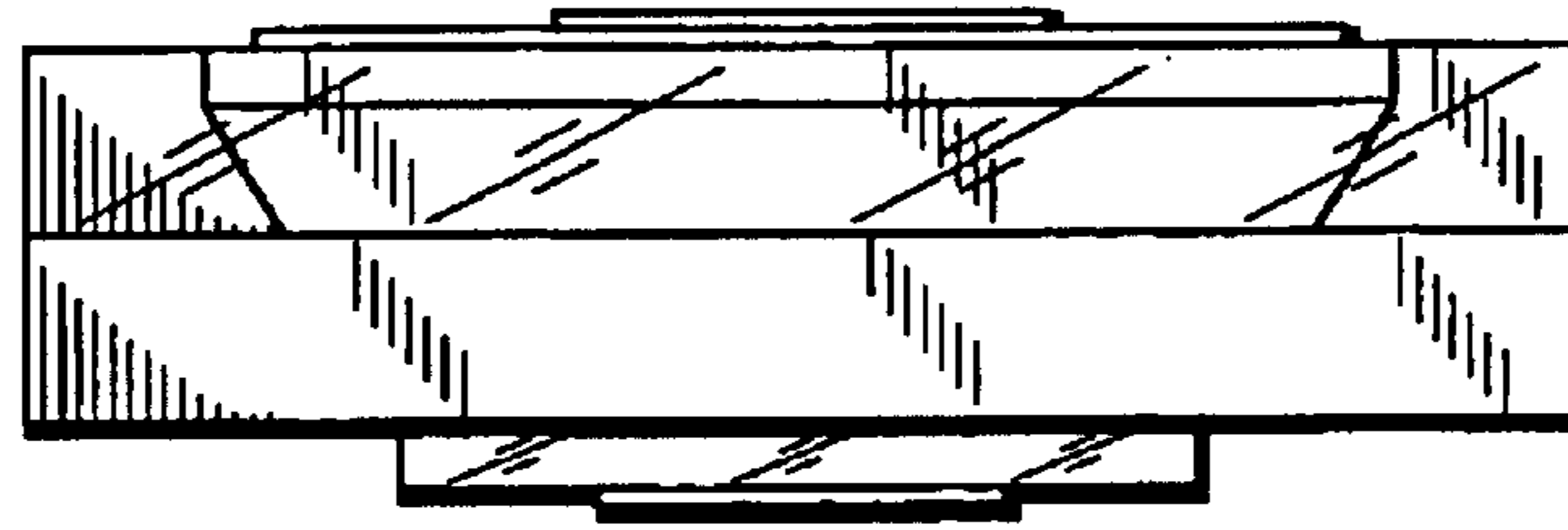
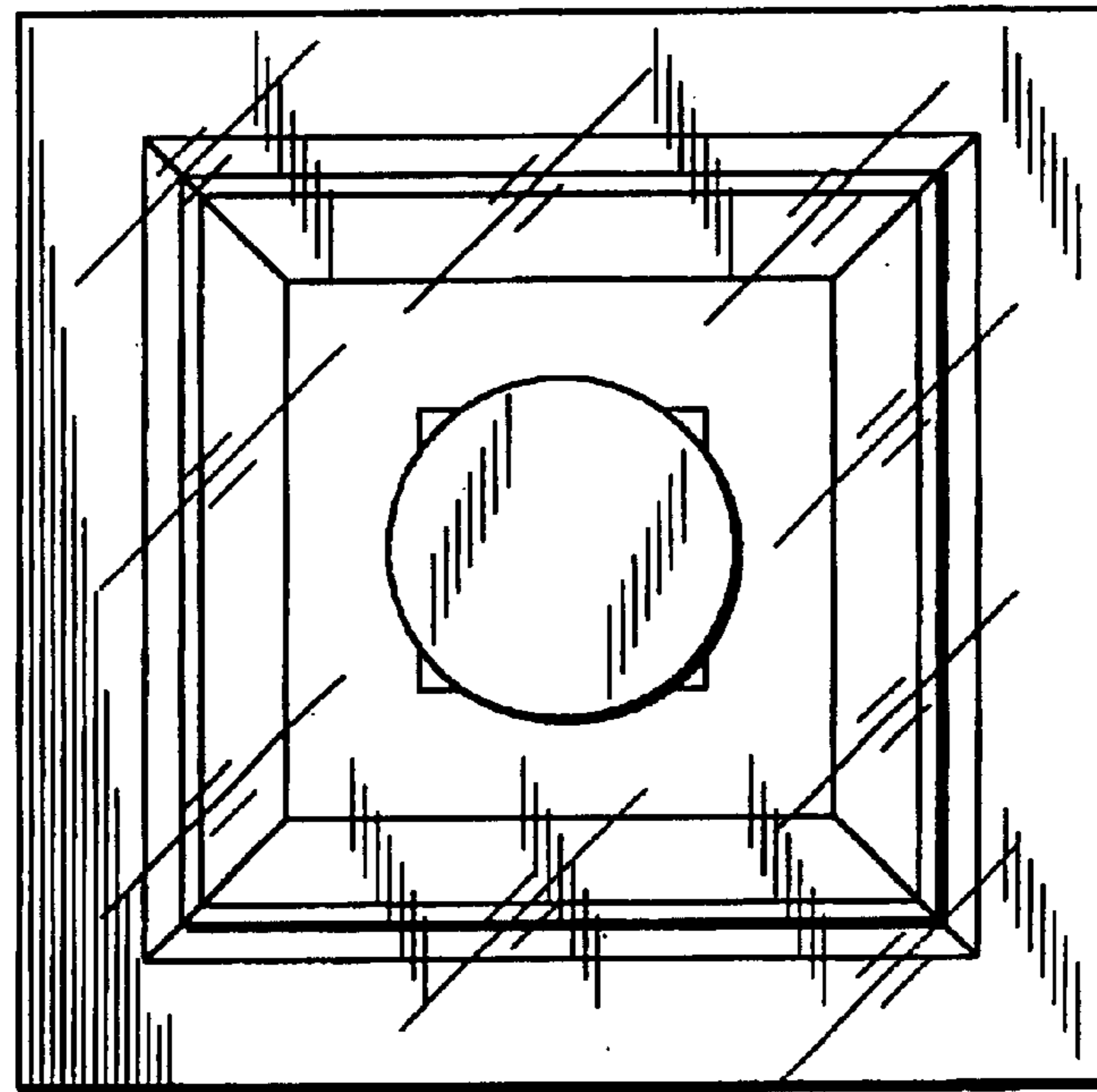

FIG.31

35 ←



35 ←

FIG.32

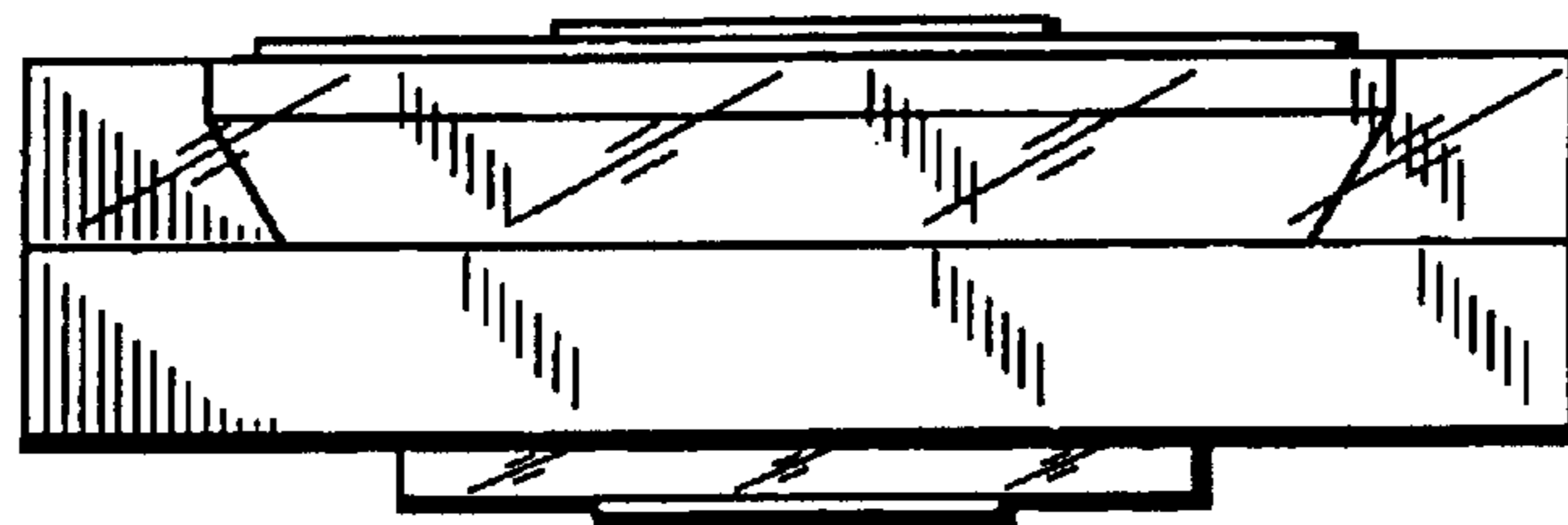

FIG.33



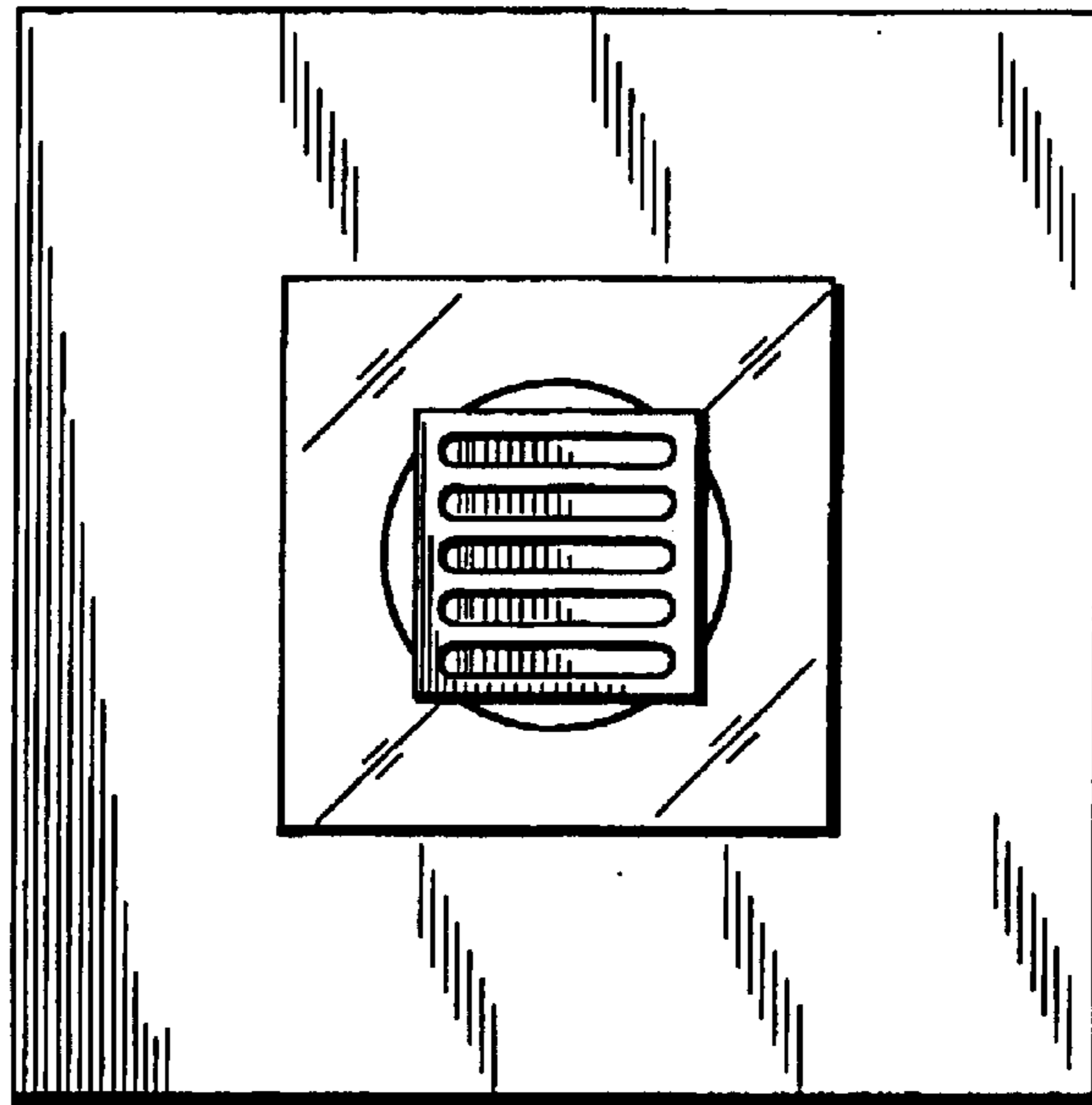

FIG.34

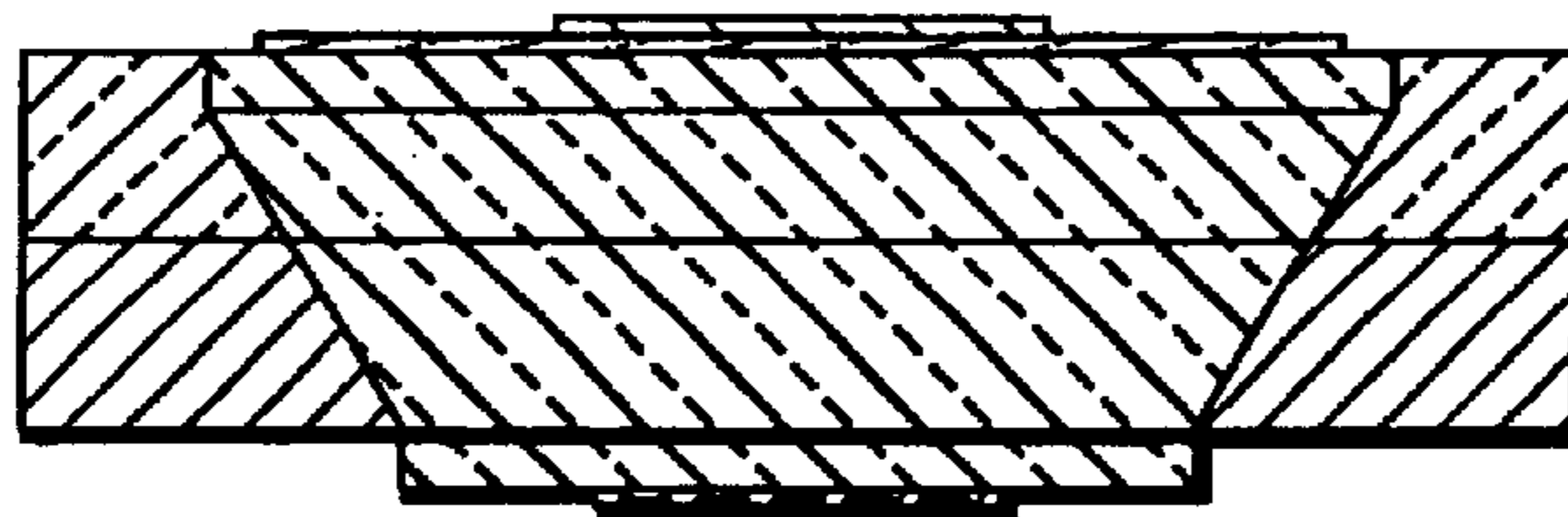

FIG.35

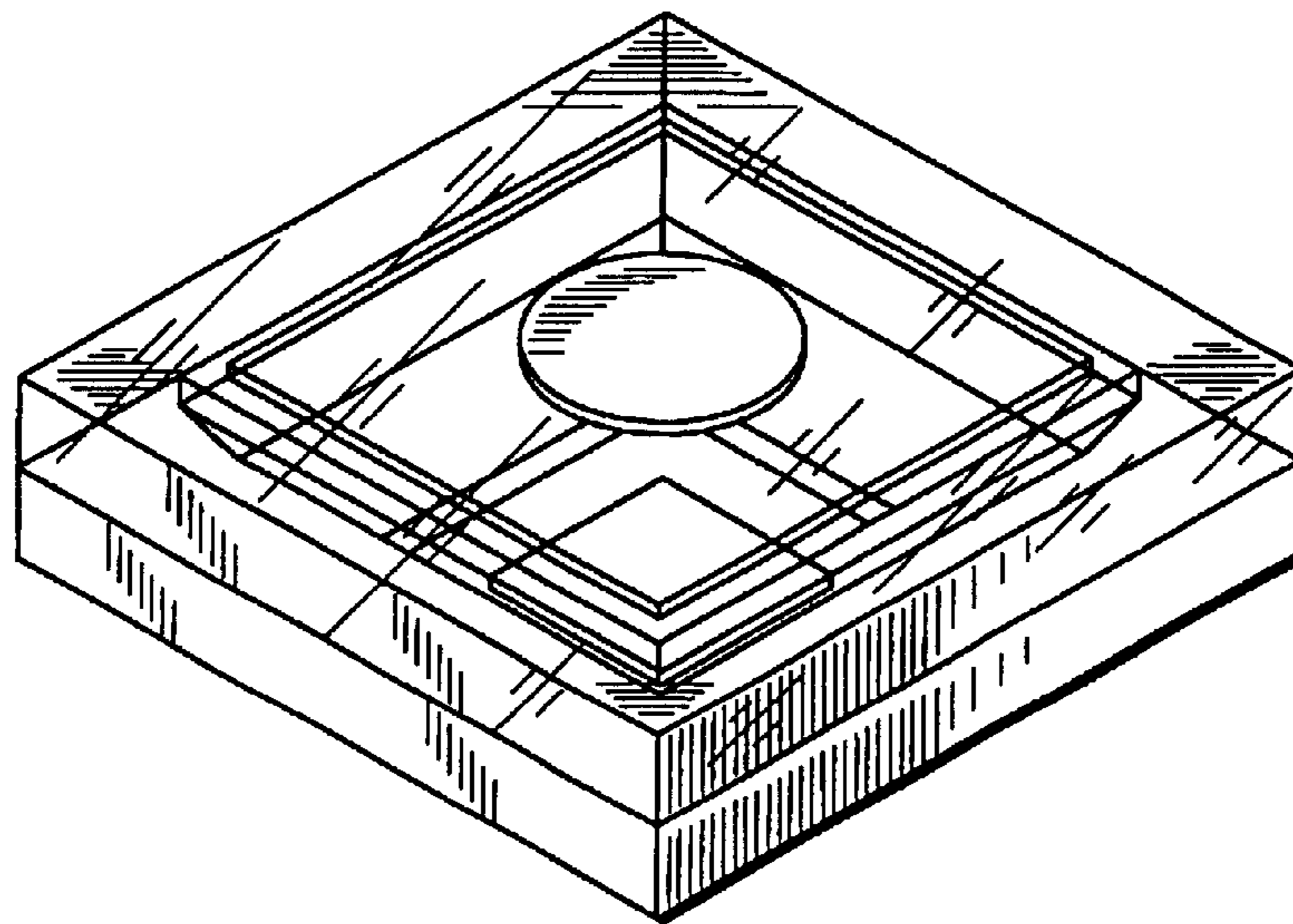

FIG.36