

US00D536304S

(12) **United States Design Patent**  
**Czyz et al.**

(10) **Patent No.:** **US D536,304 S**  
(45) **Date of Patent:** **\*\* Feb. 6, 2007**

(54) **POWER POST**  
(75) Inventors: **Marian Czyz**, Niles, IL (US); **Russel Nelson**, Cystal Lake, IL (US)  
(73) Assignee: **Intermatic Incorporated**, Spring Grove, IL (US)  
(\*\*) Term: **14 Years**  
(21) Appl. No.: **29/228,771**  
(22) Filed: **Apr. 28, 2005**  
(51) **LOC (8) Cl.** ..... **13-03**  
(52) **U.S. Cl.** ..... **D13/139.5**  
(58) **Field of Classification Search** ..... D13/139.1, D13/139.4, 139.5, 139.6, 139.8, 184; 174/37-39; 361/622, 641  
See application file for complete search history.

D384,031 S \* 9/1997 Lui ..... D13/103  
5,773,760 A 6/1998 Stark et al.  
D413,564 S \* 9/1999 Hershberger et al. .... D13/103  
D417,293 S 11/1999 Carter  
D436,917 S \* 1/2001 Hayakawa et al. .... D13/103  
6,260,314 B1 7/2001 Church et al.  
D456,002 S \* 4/2002 Kato et al. .... D13/103  
D477,811 S \* 7/2003 Niwa et al. .... D13/103  
D481,672 S \* 11/2003 Niwa et al. .... D13/103  
6,863,251 B1 3/2005 Gretz  
D511,744 S \* 11/2005 Hsu et al. .... D13/108  
D512,373 S \* 12/2005 Tsai et al. .... D13/108  
D512,961 S \* 12/2005 Okuda et al. .... D13/103  
D516,504 S \* 3/2006 Okuda et al. .... D13/103  
D523,807 S \* 6/2006 Murayama et al. .... D13/103  
D524,728 S \* 7/2006 Watson ..... D13/103

\* cited by examiner

*Primary Examiner*—Alan P. Douglas  
*Assistant Examiner*—Rosemary K. Tarcza  
(74) *Attorney, Agent, or Firm*—Brinks Hofer Gilson & Lione

(56) **References Cited**  
U.S. PATENT DOCUMENTS

3,257,496 A 6/1966 Hamilton  
3,435,124 A 3/1969 Channell  
3,585,456 A 6/1971 Phillips, Jr.  
3,652,779 A 3/1972 Grinols  
3,868,474 A 2/1975 Bunten  
4,025,825 A 5/1977 Shrader  
4,076,198 A 2/1978 Garrett  
4,266,266 A 5/1981 Sanner  
4,519,657 A 5/1985 Jensen  
4,546,418 A 10/1985 Baggio et al.  
4,858,877 A 8/1989 Carter  
4,951,182 A 8/1990 Simonson et al.  
5,184,279 A 2/1993 Horn  
5,404,266 A 4/1995 Orchard et al.  
5,586,742 A 12/1996 Carter  
D379,795 S \* 6/1997 Pitzen et al. .... D13/103

(57) **CLAIM**

We claim the ornamental design for a power post, as shown and described.

**DESCRIPTION**

FIG. 1 is a top perspective view of a power post of the present invention;  
FIG. 2 is a first side view thereof;  
FIG. 3 is a second side view thereof;  
FIG. 4 is a front view thereof;  
FIG. 5 is a rear view thereof;  
FIG. 6 is a top view thereof; and,  
FIG. 7 is bottom view thereof.

**1 Claim, 7 Drawing Sheets**

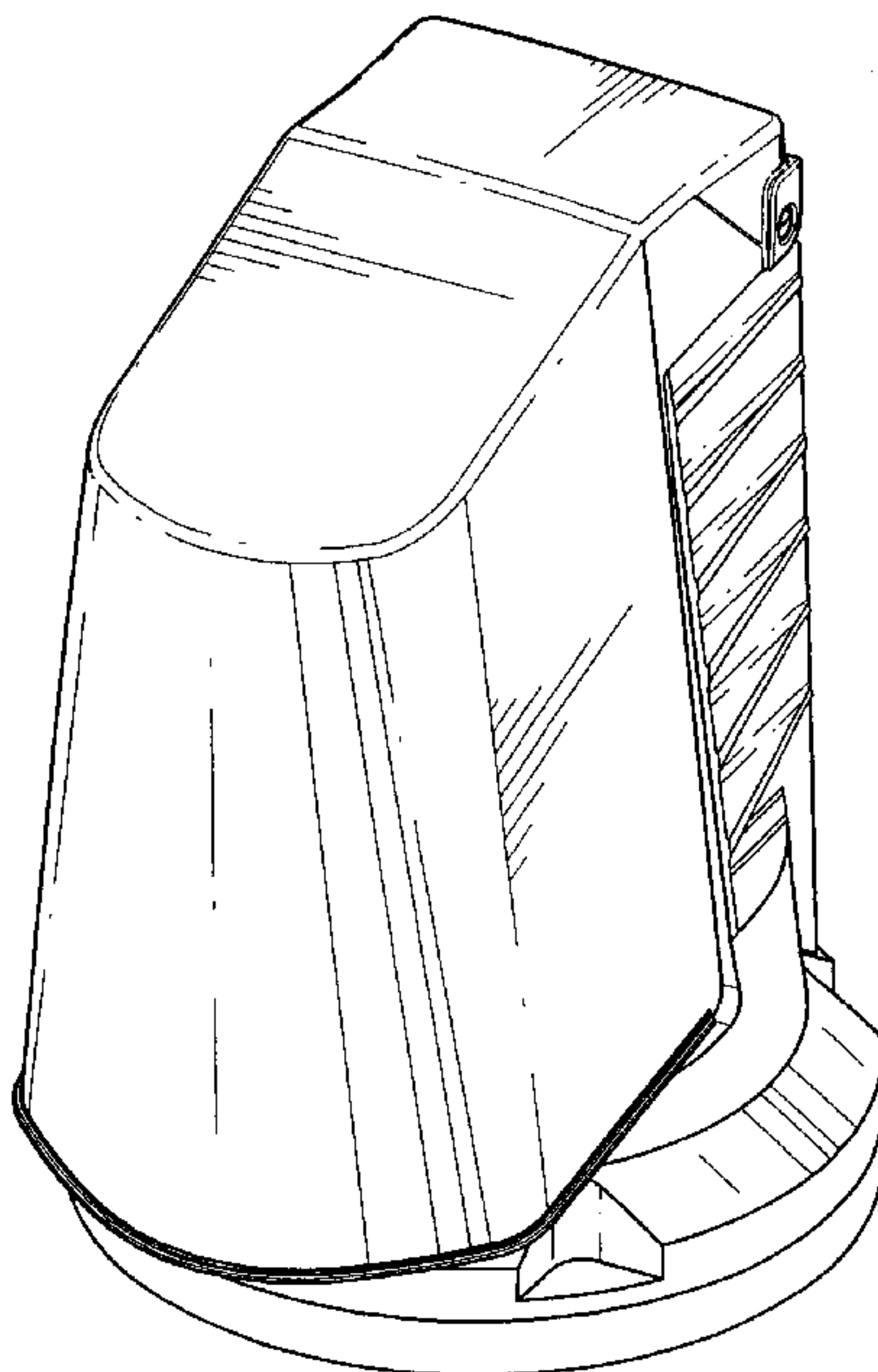

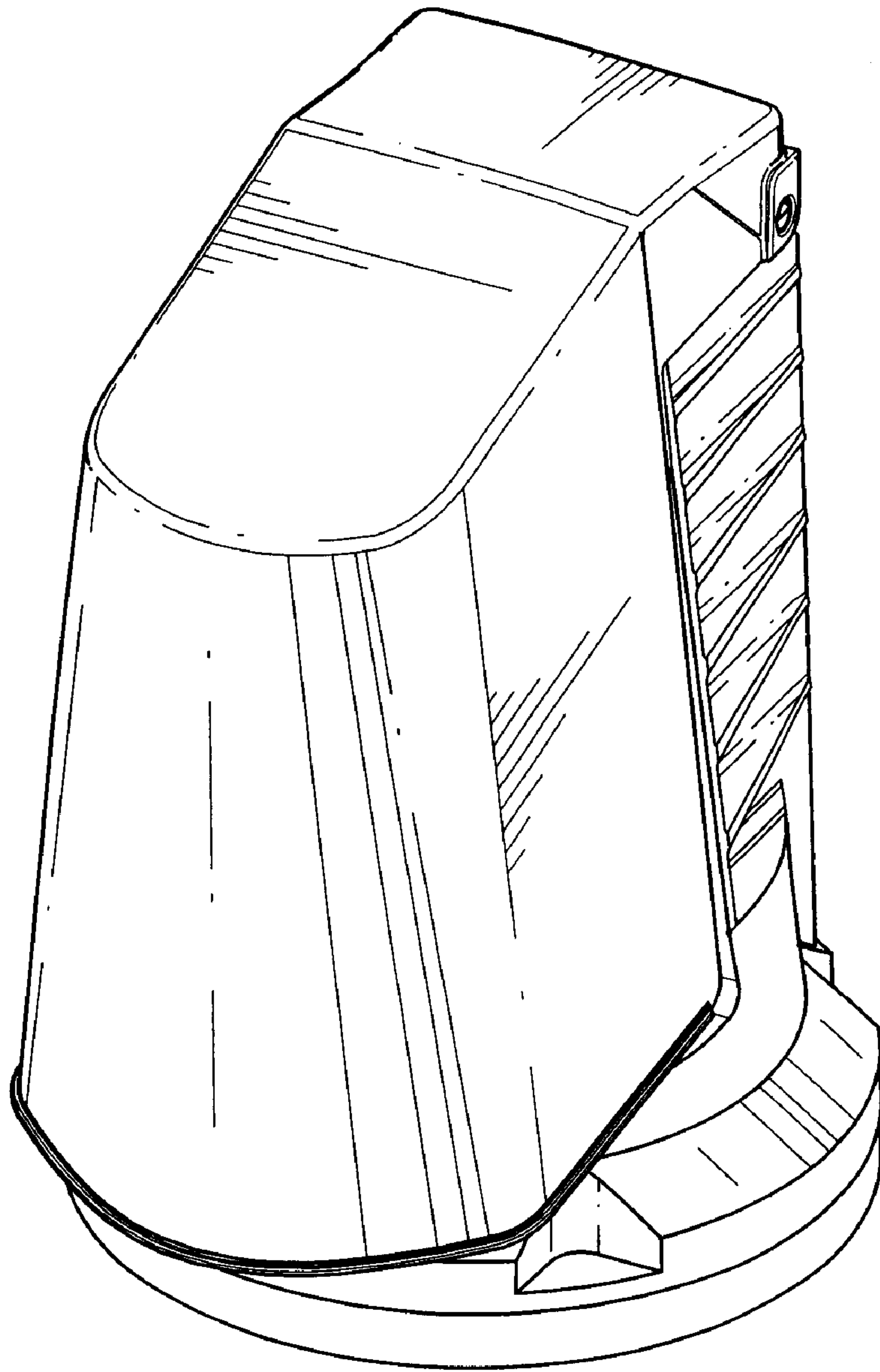

FIG. 1

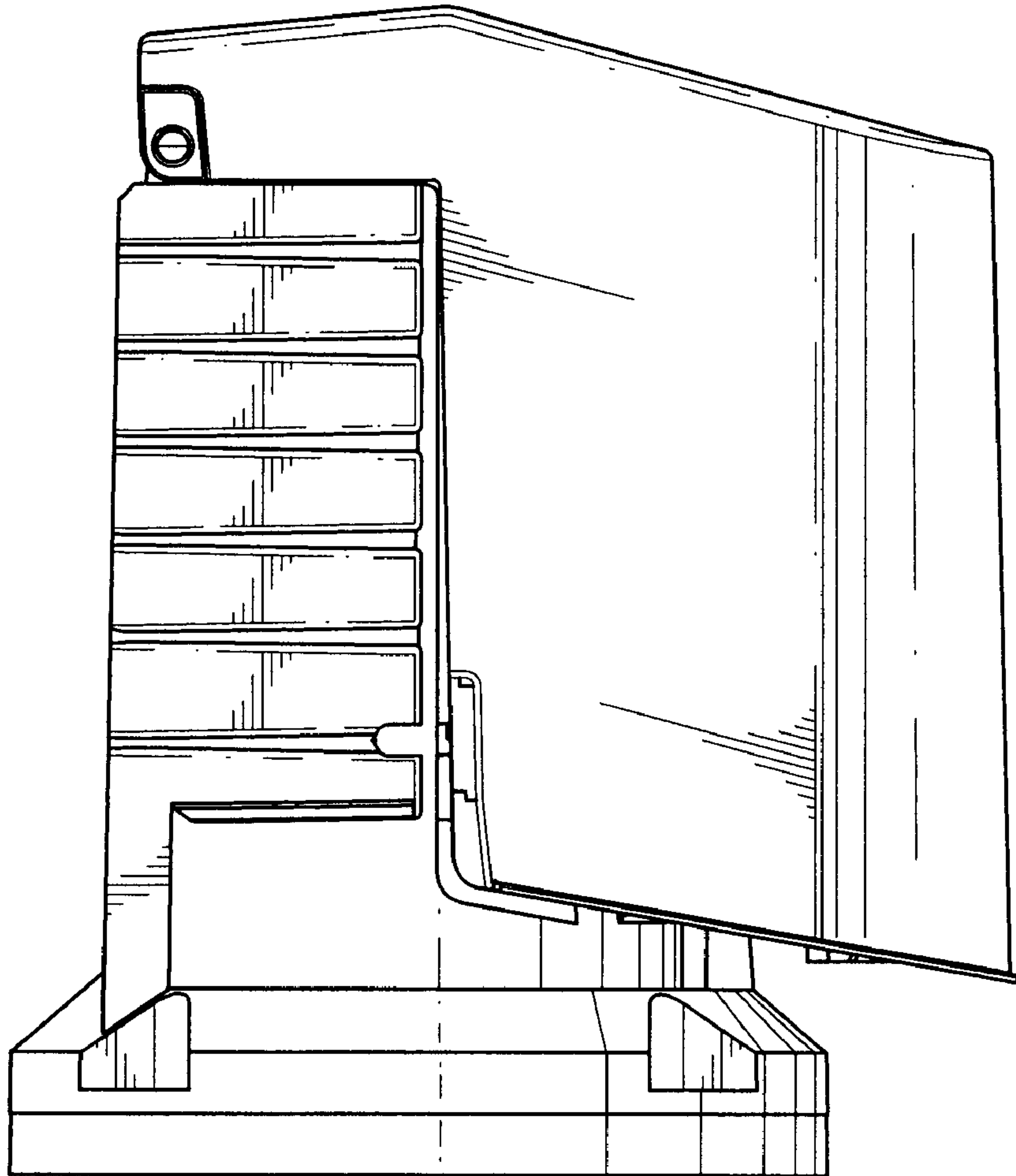

FIG. 2

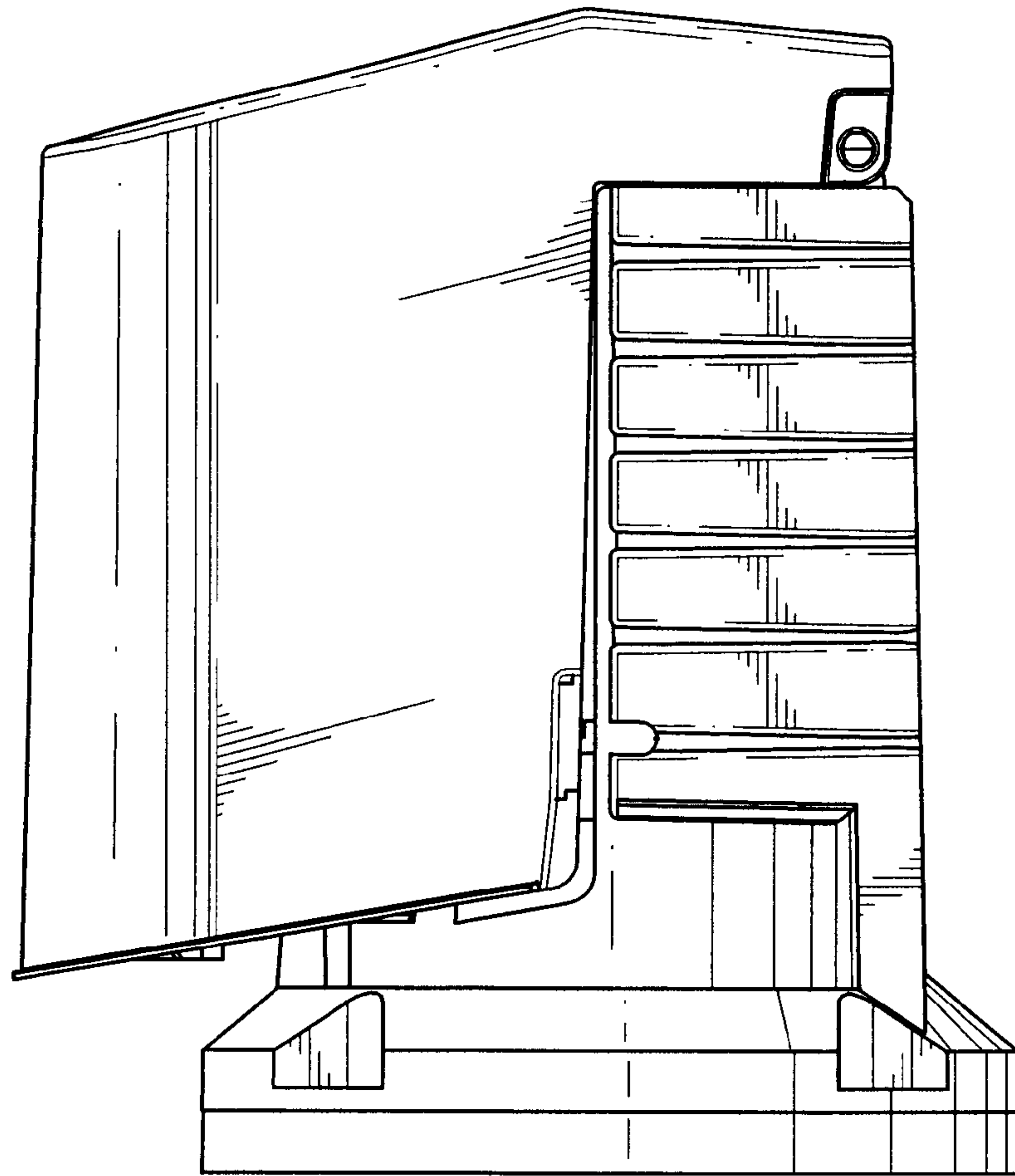

FIG. 3

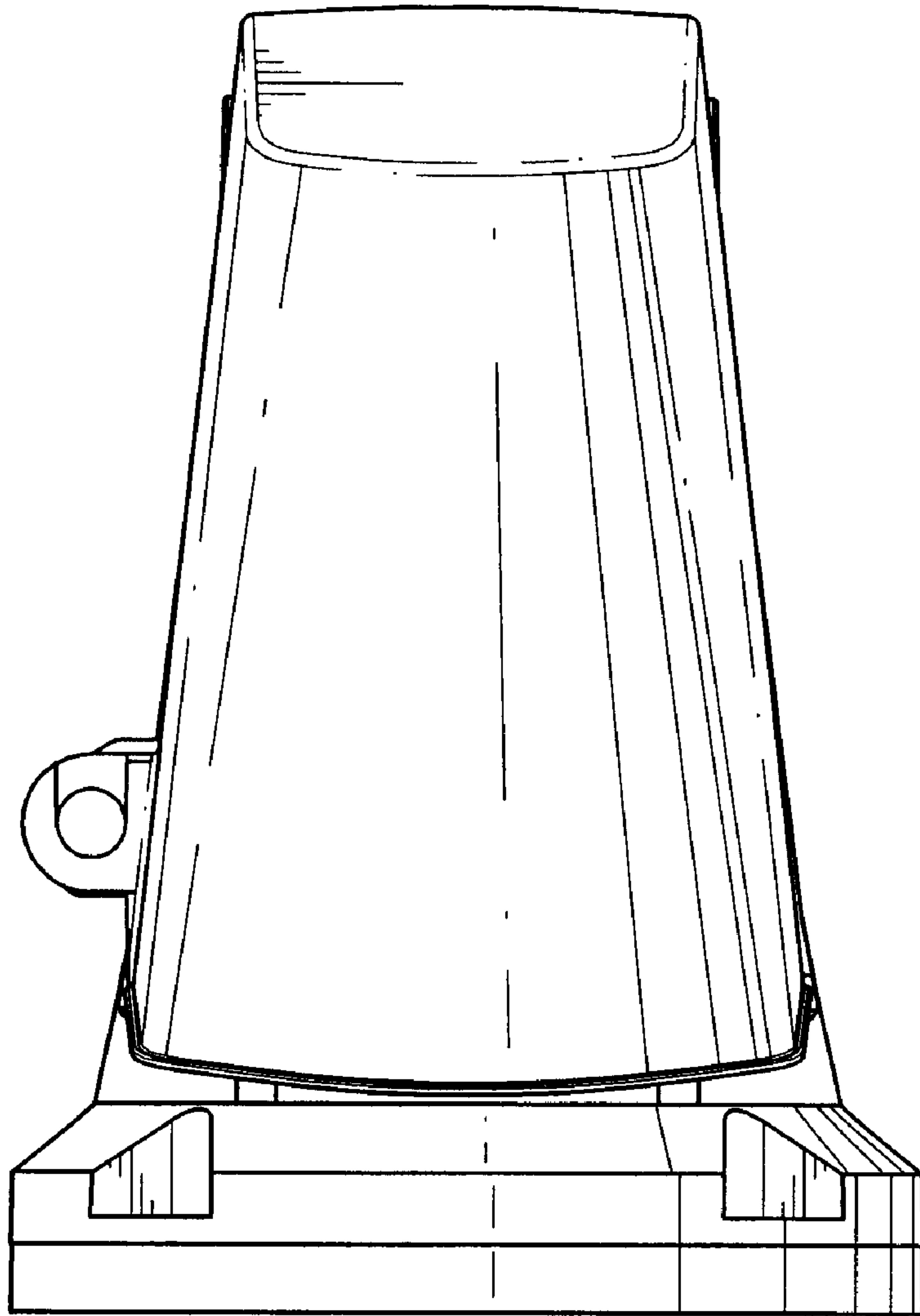

FIG. 4

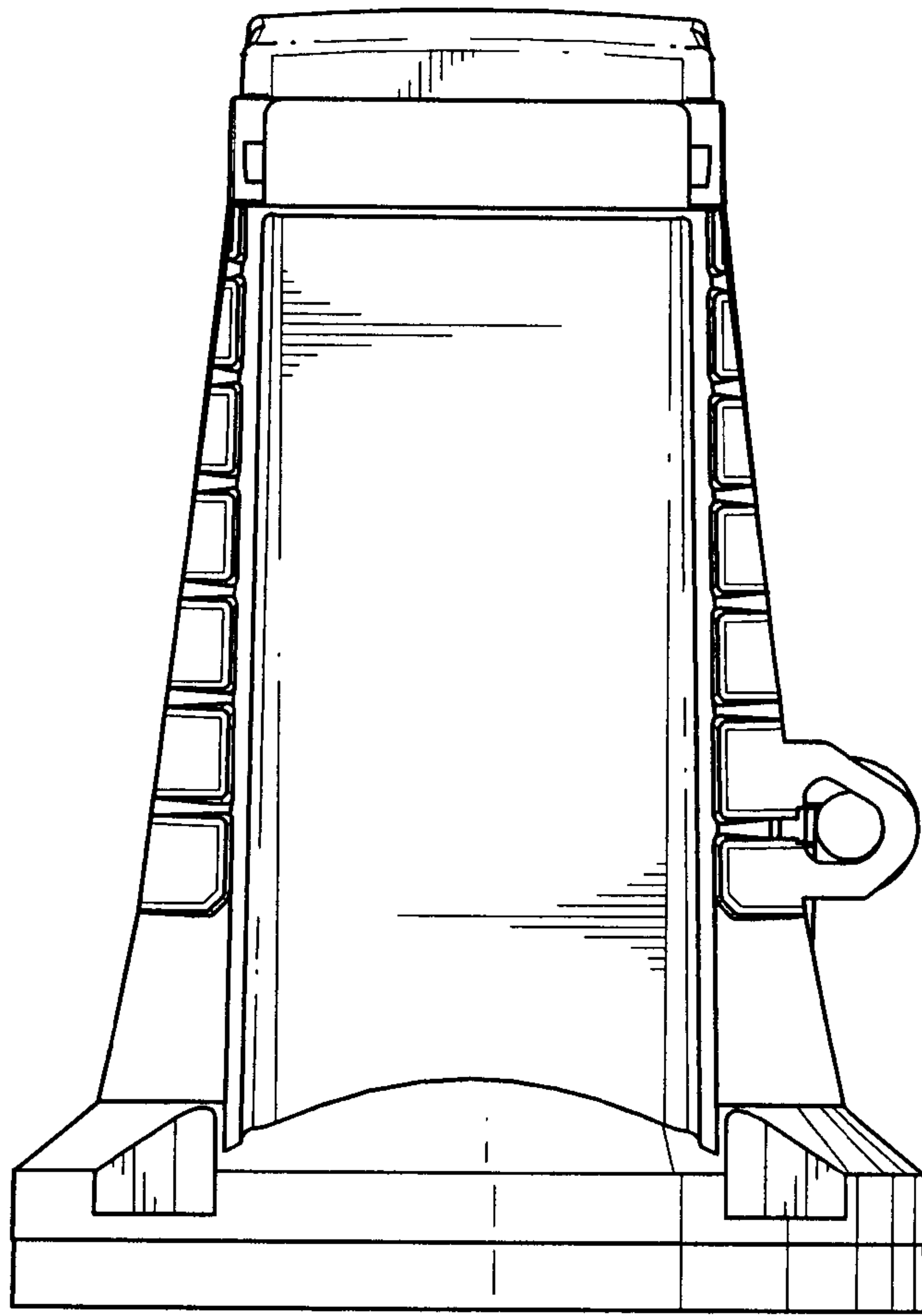

FIG. 5

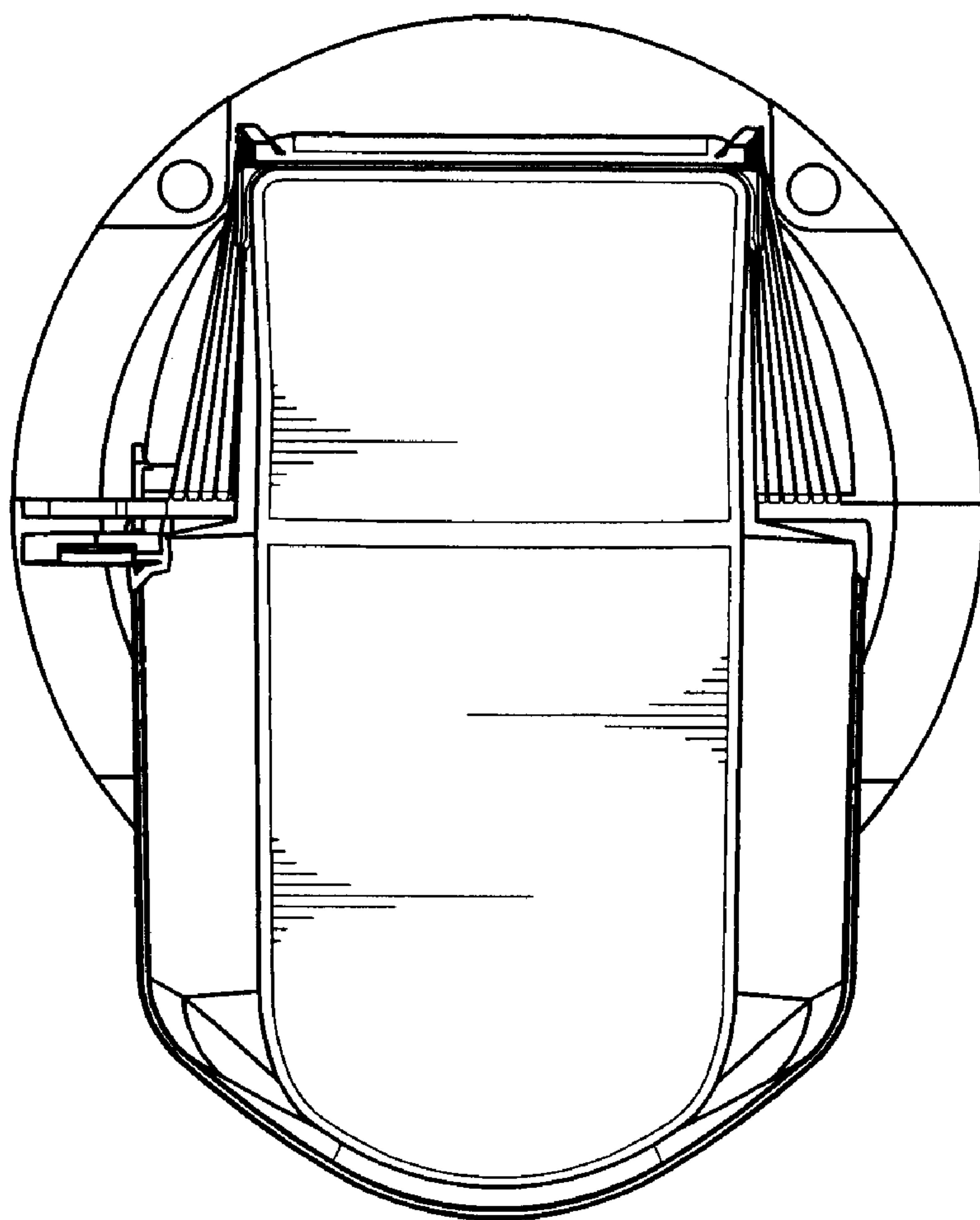

FIG. 6



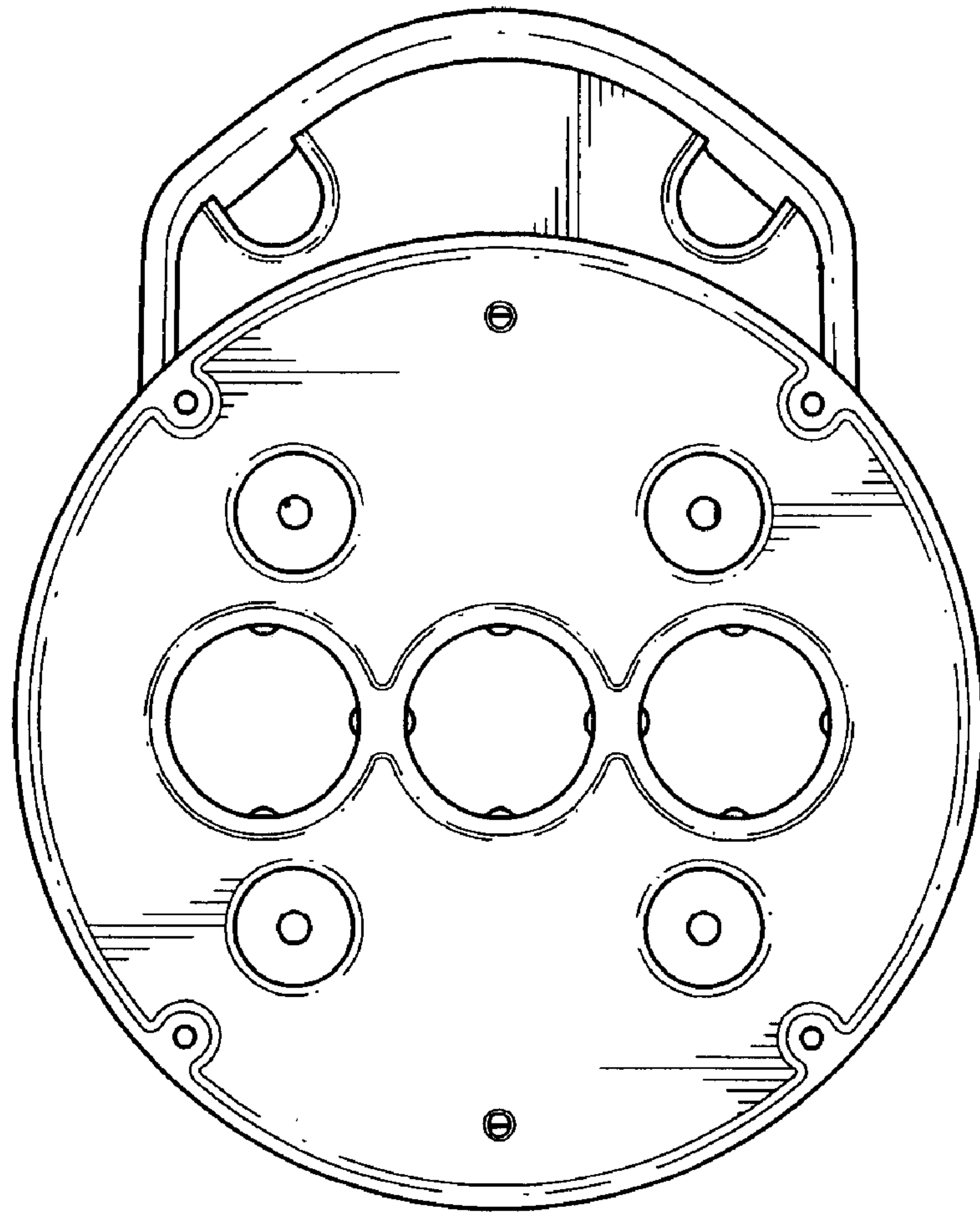

FIG. 7