



US00D536240S

(12) **United States Design Patent**  
**Vejmarker**

(10) **Patent No.:** **US D536,240 S**

(45) **Date of Patent:** **\*\* Feb. 6, 2007**

(54) **NOGGIN HEAD BRACE**

(75) Inventor: **Bo Vejmarker**, Trelleborg (SE)

(73) Assignee: **BPB plc**, Slough (GB)

(\*\*) Term: **14 Years**

(21) Appl. No.: **29/255,196**

(22) Filed: **Mar. 6, 2006**

**Related U.S. Application Data**

(62) Division of application No. 29/201,151, filed on Mar. 11, 2004, now Pat. No. Des. 520,344.

(30) **Foreign Application Priority Data**

Sep. 12, 2003 (SE) ..... 03-0822

(51) **LOC (8) Cl.** ..... **08-05**

(52) **U.S. Cl.** ..... **D8/354**

(58) **Field of Classification Search** ..... D8/349,  
D8/354, 380; 248/200, 300, 27.1  
See application file for complete search history.

(56) **References Cited**

**U.S. PATENT DOCUMENTS**

- 1,860,760 A \* 5/1932 Wittemann ..... 248/300
- 2,235,761 A 3/1941 Goldsmith
- 2,369,687 A 2/1945 Ralston
- D272,414 S 1/1984 Barnes
- D330,503 S \* 10/1992 Rana ..... D8/349
- D432,901 S \* 10/2000 McDonald ..... D8/354
- D442,469 S \* 5/2001 Roozen et al. .... D8/354
- 6,497,395 B1 \* 12/2002 Croker ..... 248/300
- D468,191 S 1/2003 Burke
- D472,793 S 4/2003 Callahan et al.
- D483,651 S 12/2003 Sander

- 6,669,156 B2 \* 12/2003 East et al. .... 248/300
- D487,391 S 3/2004 Balaban
- D487,867 S \* 3/2004 Balaban ..... D8/354
- D489,598 S \* 5/2004 Balaban ..... D8/354
- D492,189 S 6/2004 Weremchuk et al.
- D492,888 S 7/2004 Wilson
- D500,666 S 1/2005 Murphy et al.
- D500,667 S 1/2005 Murphy et al.
- D503,330 S 3/2005 Murphy et al.

\* cited by examiner

*Primary Examiner*—Holly H. Baynham

(74) *Attorney, Agent, or Firm*—Vangelis Economou Ip Horgan Ltd.

(57) **CLAIM**

The ornamental design of the noggin head brace, as shown and described.

**DESCRIPTION**

The inventive noggin head brace provides an ornamental support for timber or steel girders when they are placed to extend perpendicularly from a side wall or stud.

FIG. 1 is a perspective view of the noggin head brace showing my new design;

FIG. 2 is a perspective view thereof, shown from an alternate angle;

FIG. 3 is an enlarged front elevational view thereof;

FIG. 4 is an enlarged back elevational view thereof;

FIG. 5 is an enlarged left side view thereof;

FIG. 6 is an enlarged right side view thereof;

FIG. 7 is an enlarged top view thereof; and,

FIG. 8 is an enlarged bottom view thereof.

FIGS. 3–8 have been shown on an enlarged scale in respect to FIGS. 1 and 2.

**1 Claim, 6 Drawing Sheets**

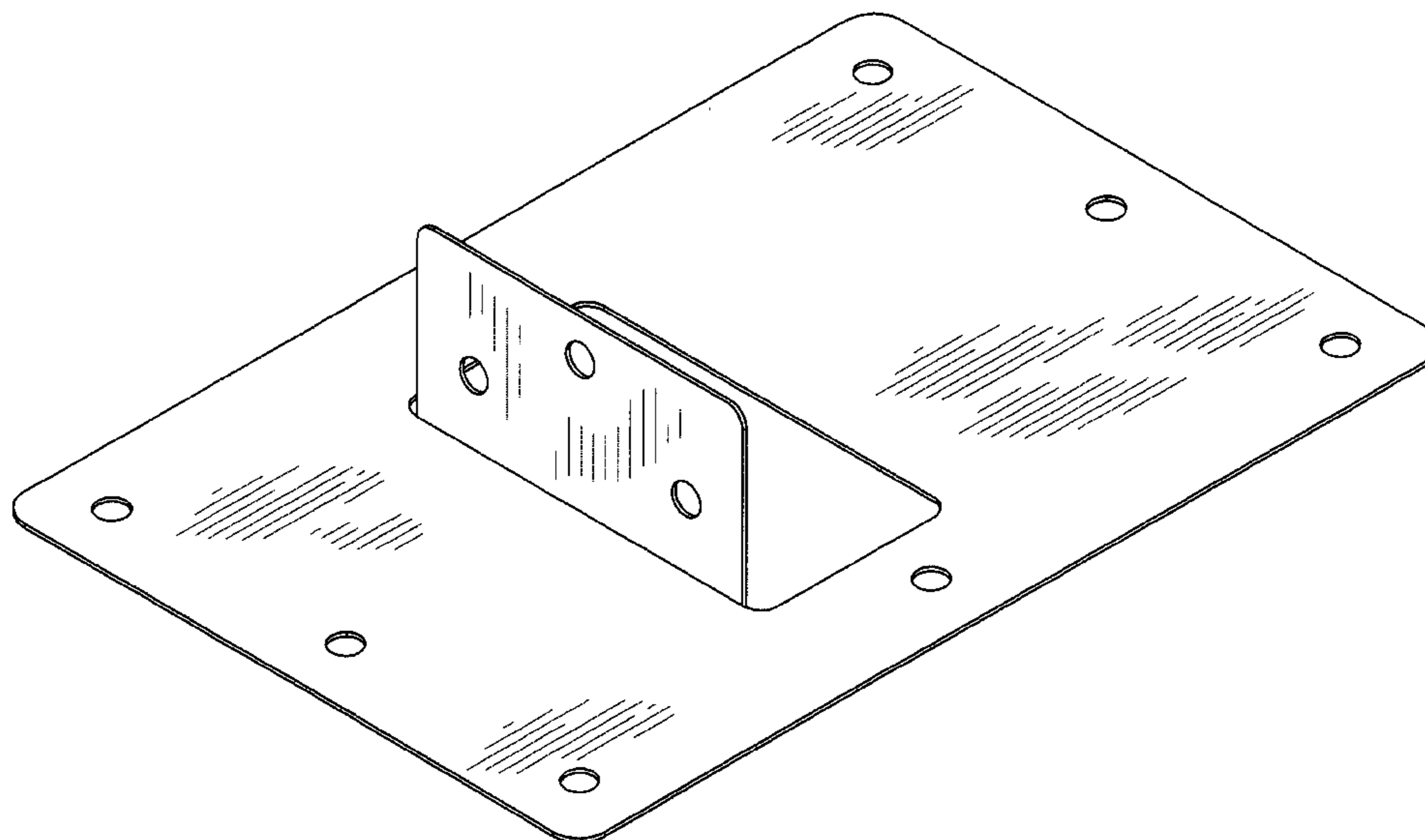

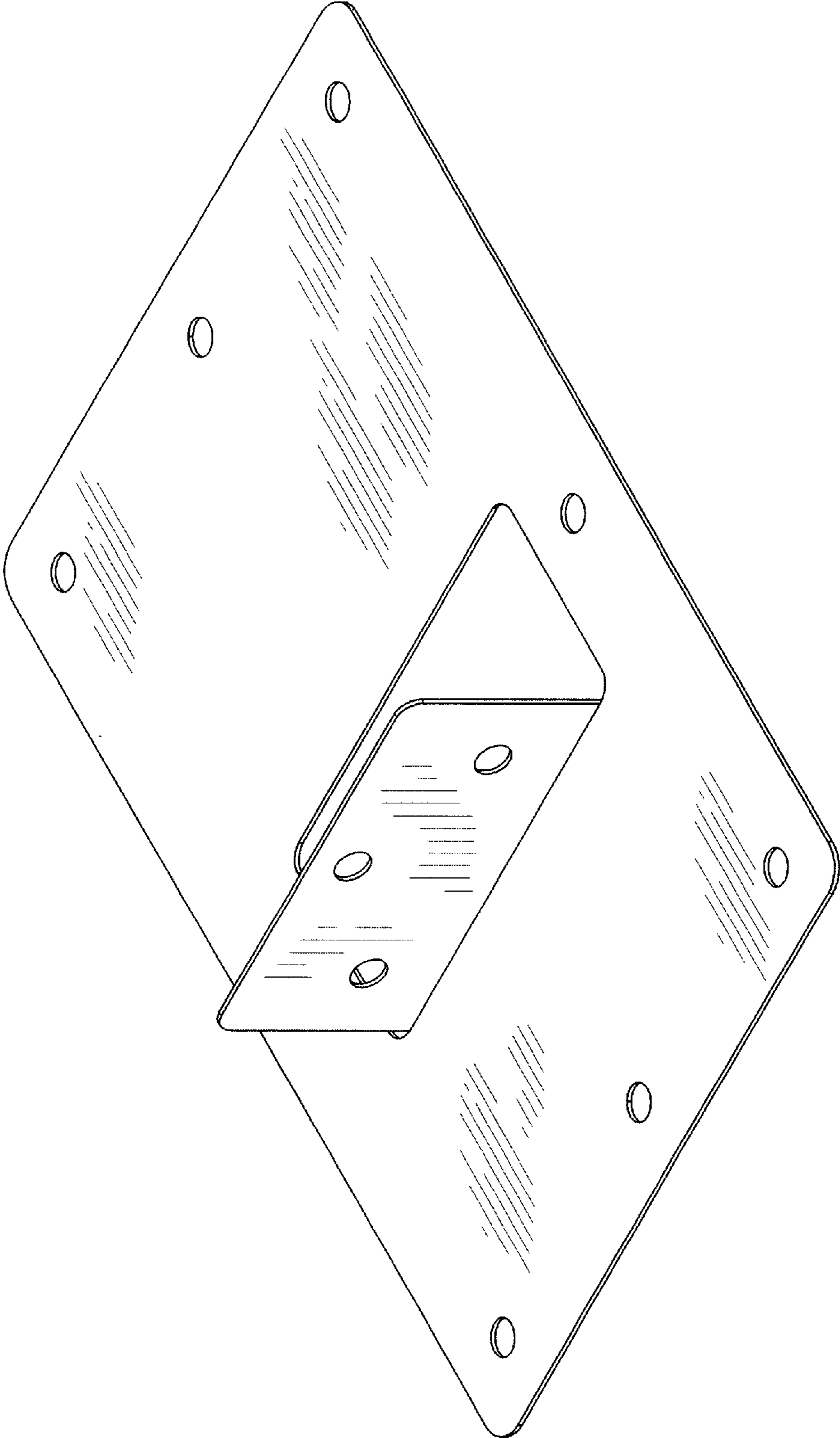

FIG. 1

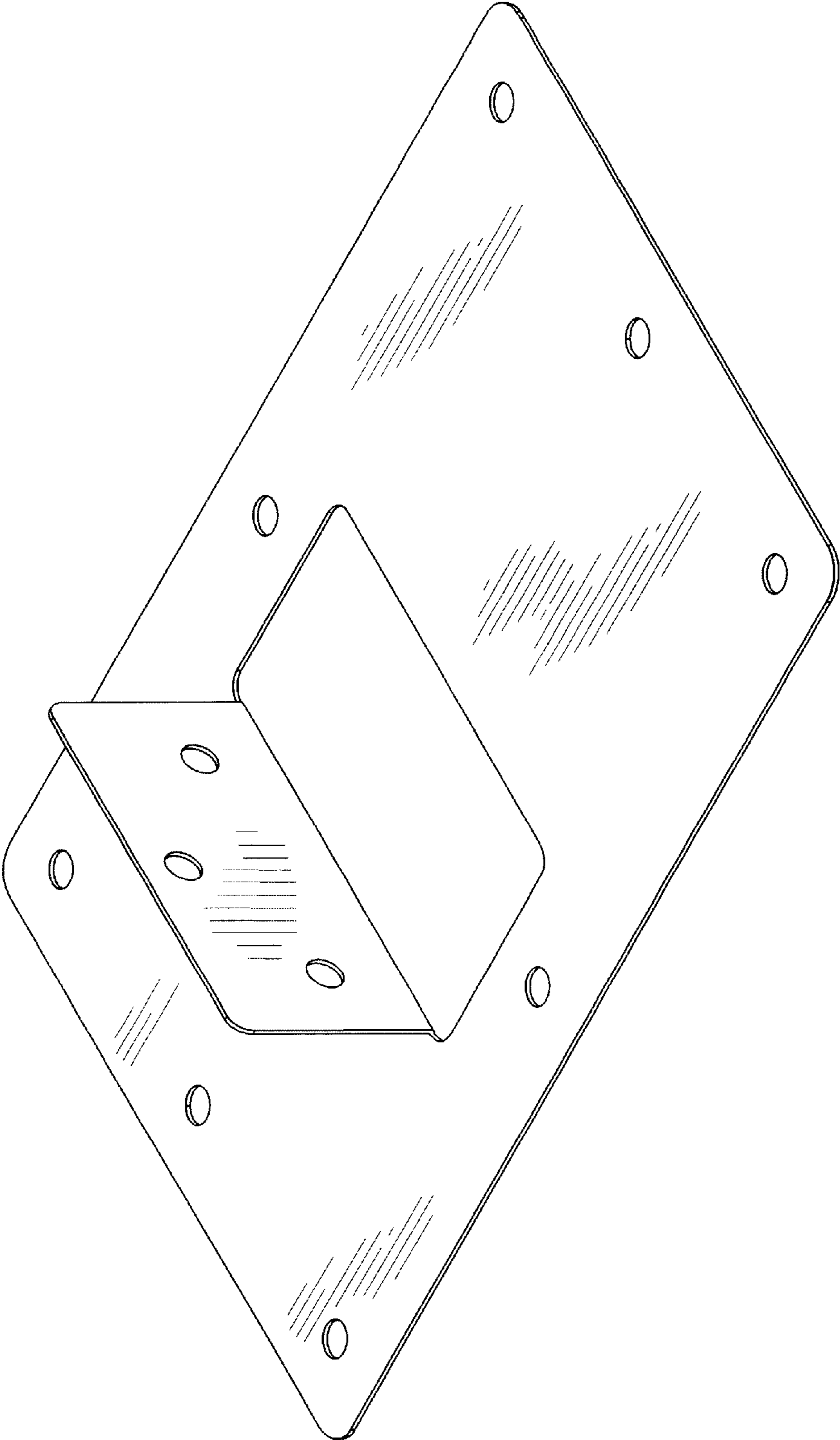

FIG. 2

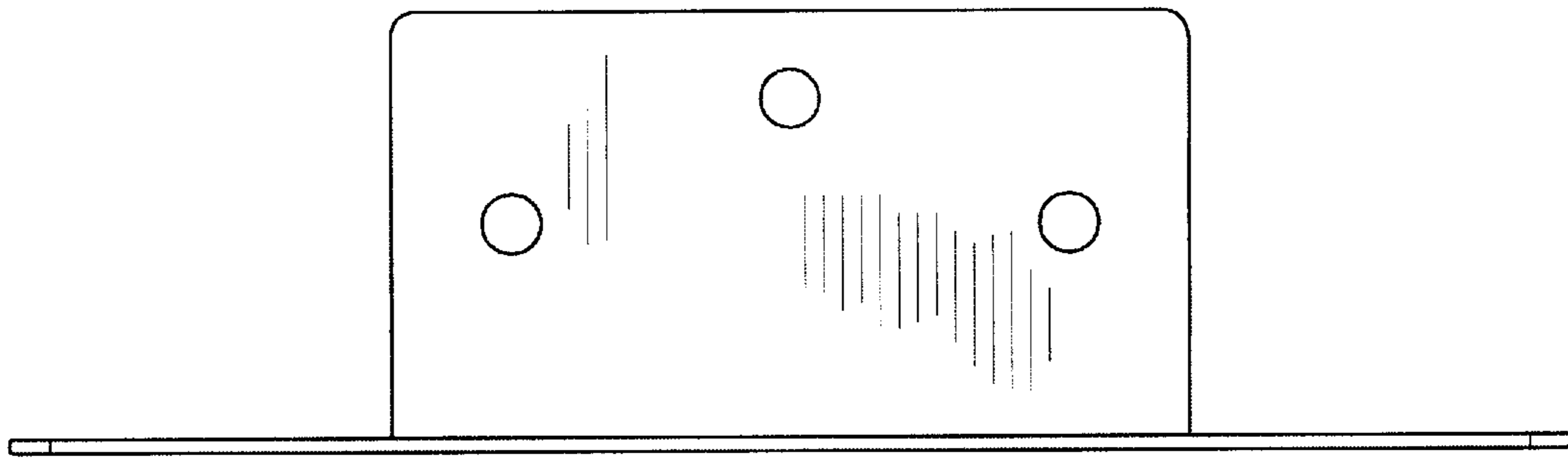

FIG. 3

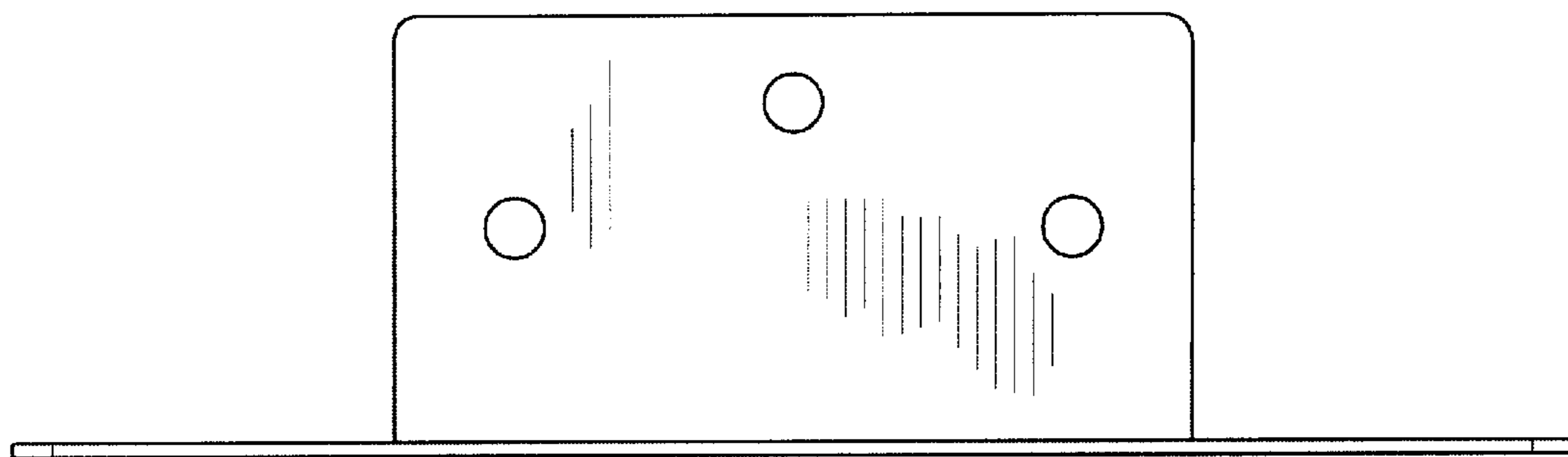

FIG. 4

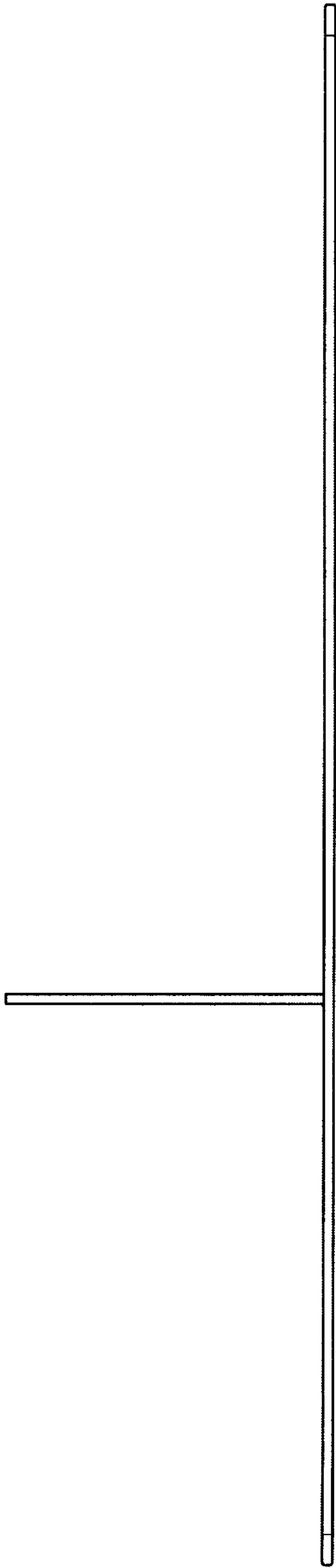

FIG. 5

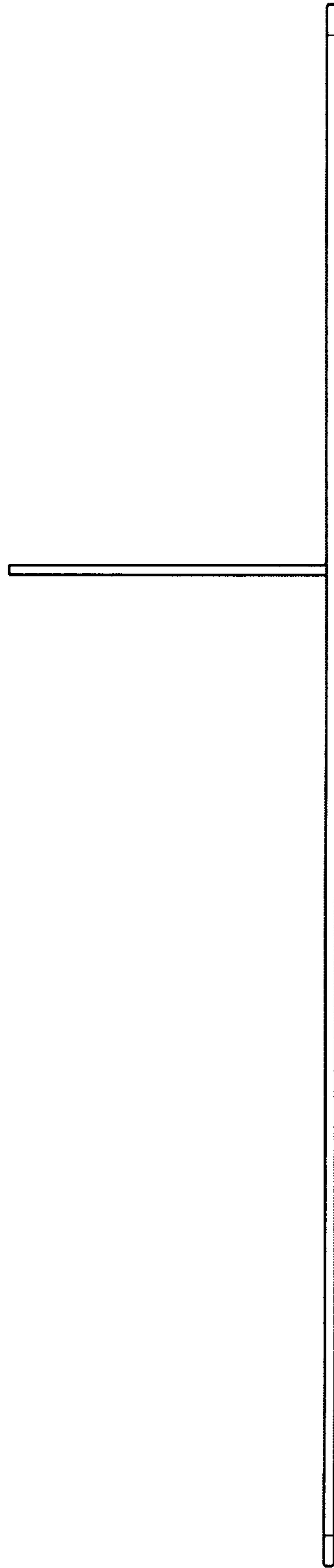

FIG. 6

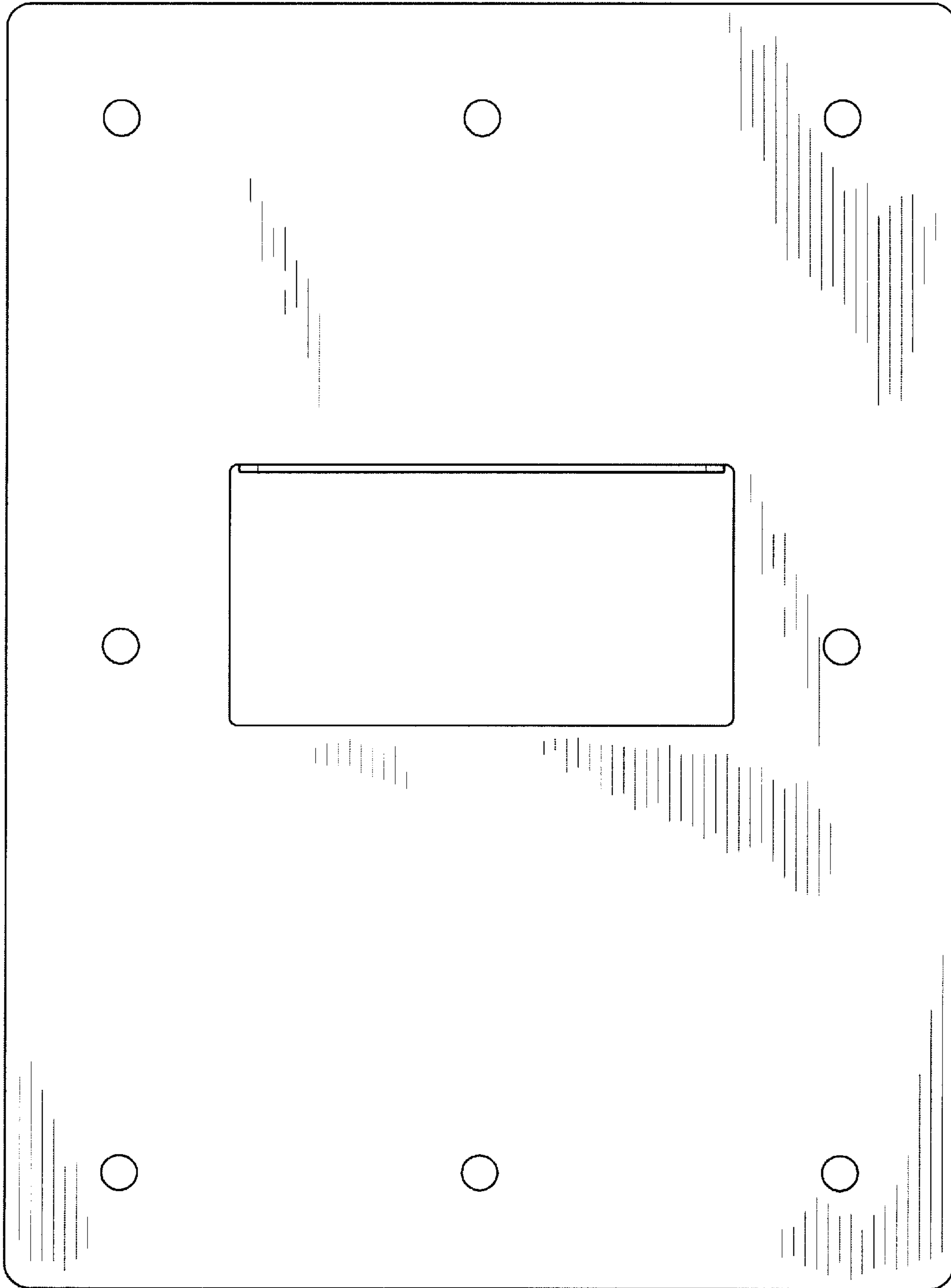

FIG. 7

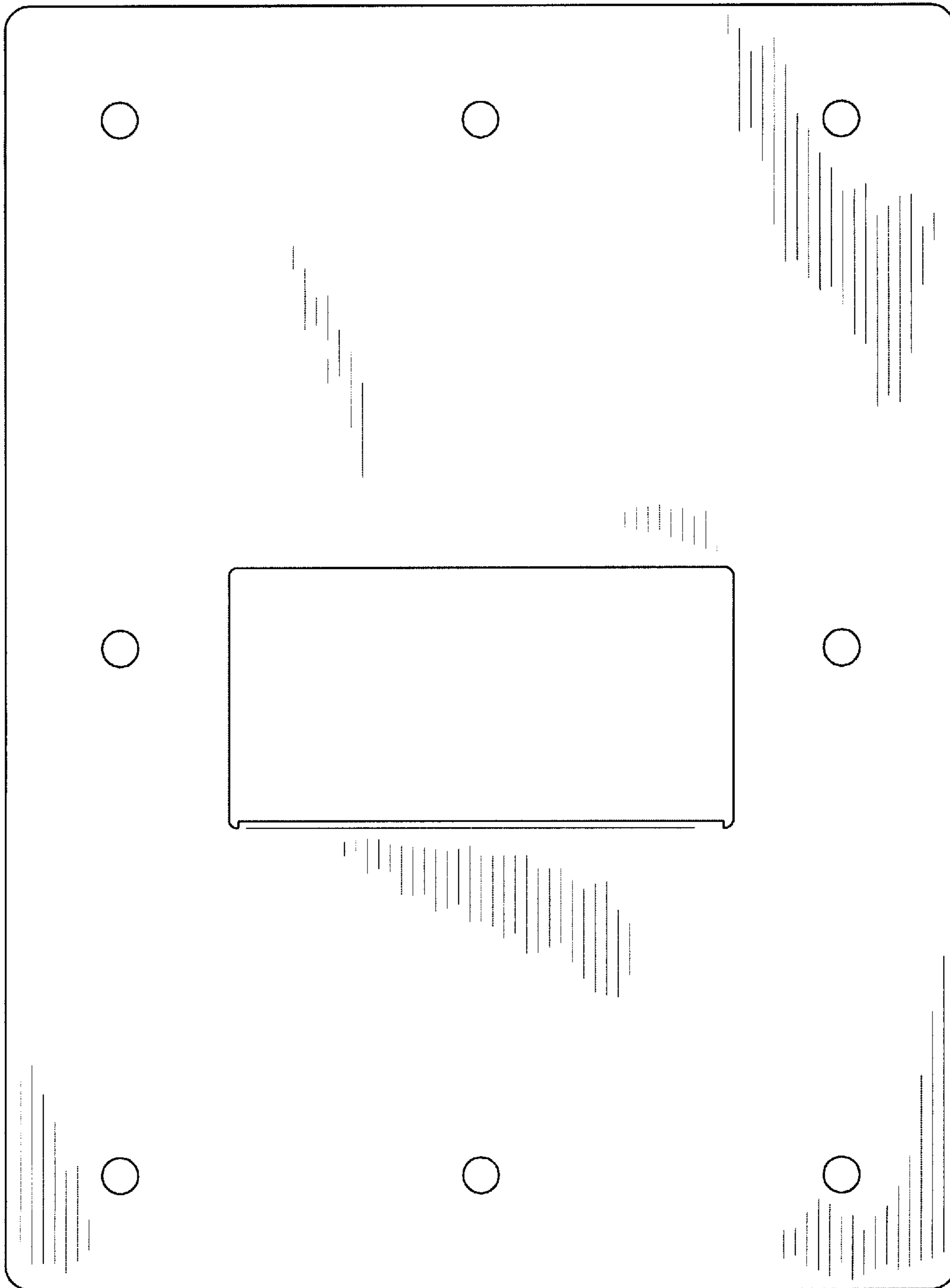

FIG. 8