



US00D536222S

(12) **United States Design Patent**
Heiberg et al.

(10) **Patent No.:** **US D536,222 S**

(45) **Date of Patent:** **** Feb. 6, 2007**

(54) **KNIFE, FORK AND SPOONS SET**

DESCRIPTION

(75) Inventors: **Jakob Heiberg**, Charlottenlund (DK);
Dorte Sondergaard, Frederiksberg C (DK);
Douglas M. Laib, Orlando, FL (US)

(73) Assignee: **Dart Industries, Inc.**, Orlando, FL (US)

(**) Term: **14 Years**

(21) Appl. No.: **29/231,745**

(22) Filed: **Jun. 8, 2005**

(51) **LOC (8) Cl.** **07-03**

(52) **U.S. Cl.** **D7/645**

(58) **Field of Classification Search** D7/368,
D7/393, 395, 401.2, 575, 642-664, 669, 676,
D7/683, 688-692; D8/82, 83, 88, 89, 107;
30/137, 141, 142, 147-150, 322-329, 340,
30/342-345; 416/70 R

See application file for complete search history.

(56) **References Cited**

U.S. PATENT DOCUMENTS

1,053,387	A	*	2/1913	Hawley	30/147
D216,482	S	*	1/1970	Wentzel	D7/653
4,317,284	A	*	3/1982	Prindle	30/340
4,524,512	A	*	6/1985	Formo et al.	30/147

(Continued)

FOREIGN PATENT DOCUMENTS

WO WO 2005030016 A1 * 4/2005

Primary Examiner—Cathron C. Brooks

Assistant Examiner—Ricky Pham

(74) *Attorney, Agent, or Firm*—John A. Doninger

(57) **CLAIM**

The ornamental design for a knife, fork and spoons set, as shown and described.

FIG. 1 is an exploded perspective view of the knife, fork and spoons set showing the new design;
 FIG. 2 is a front elevation view thereof;
 FIG. 3 is a rear elevation view thereof;
 FIG. 4 is a right side elevation view thereof;
 FIG. 5 is a left side elevation view thereof;
 FIG. 6 is a top plan view thereof;
 FIG. 7 is a bottom plan view thereof;
 FIG. 8 is a top perspective view of the knife shown in FIGS. 1-8, shown separately for ease of illustration;
 FIG. 9 is a front elevation view thereof;
 FIG. 10 is a rear elevation view thereof;
 FIG. 11 is a right side elevation view thereof;
 FIG. 12 is a left side elevation view thereof;
 FIG. 13 is a top plan view thereof;
 FIG. 14 is a bottom plan view thereof;
 FIG. 15 is a top perspective view of the fork shown in FIGS. 1-8, shown separately for ease of illustration;
 FIG. 16 is a front elevation view thereof, the rear elevation being a mirror image thereof;
 FIG. 17 is a right side elevation view thereof;
 FIG. 18 is a left side elevation view thereof;
 FIG. 19 is a top plan view thereof;
 FIG. 20 is a bottom plan view thereof;
 FIG. 21 is a top perspective view of the soup spoon shown in FIGS. 1-8, shown separately for ease of illustration;
 FIG. 22 is a front elevation view thereof, the rear elevation being a mirror image thereof;
 FIG. 23 is a right side elevation view thereof;
 FIG. 24 is a left side elevation view thereof;
 FIG. 25 is a top plan view thereof;
 FIG. 26 is a bottom plan view thereof;
 FIG. 27 is a top perspective view of the teaspoon shown in FIGS. 1-8, shown separately for ease of illustration;
 FIG. 28 is a front elevation view thereof, the rear elevation being a mirror image thereof;
 FIG. 29 is a right side elevation view thereof;
 FIG. 30 is a left side elevation view thereof;
 FIG. 31 is a top plan view thereof; and
 FIG. 32 is a bottom plan view thereof.

1 Claim, 12 Drawing Sheets

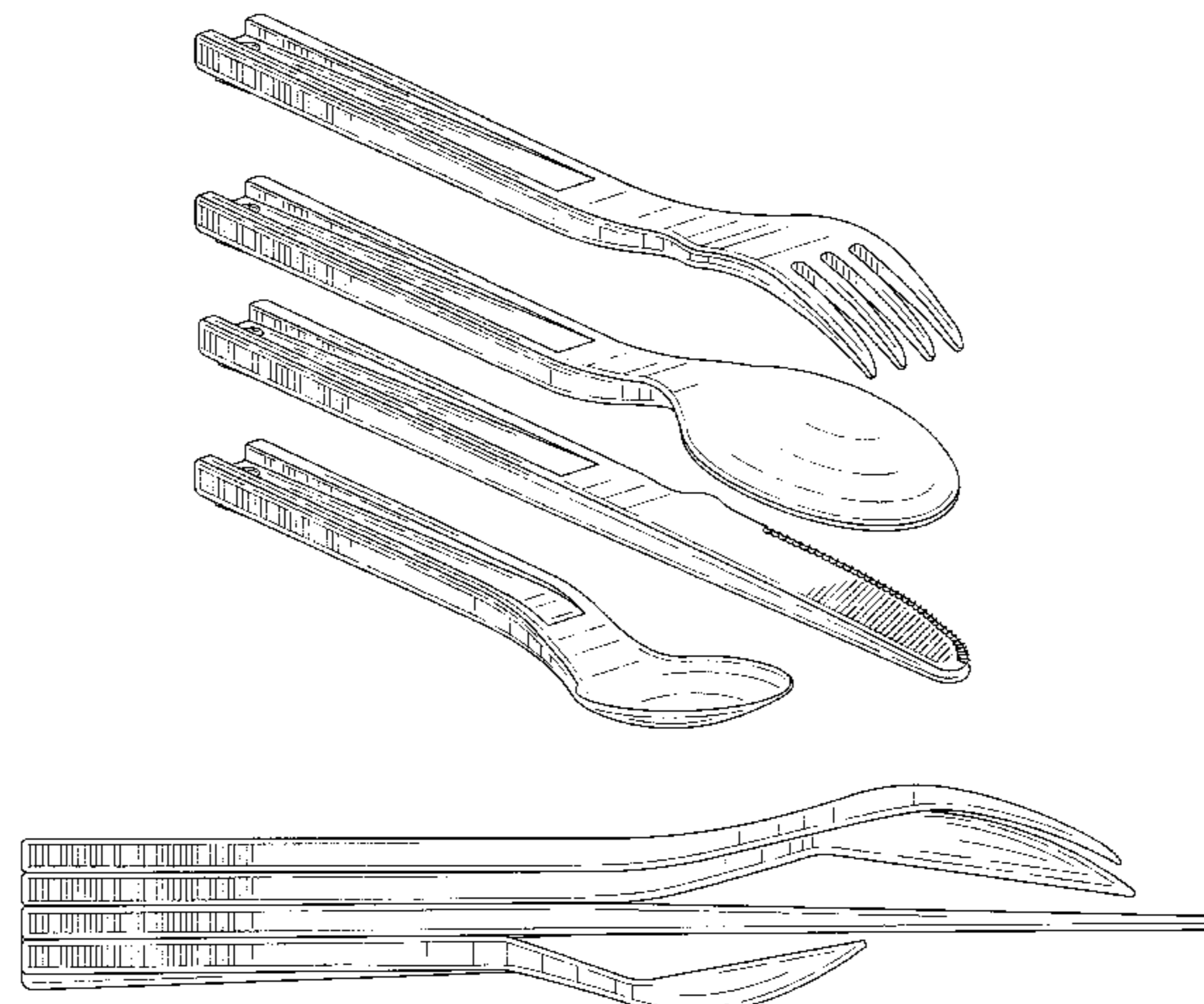

US D536,222 S

Page 2

U.S. PATENT DOCUMENTS

D284,442 S	*	7/1986	Chan	D7/645	5,590,472 A	*	1/1997	Yaakov	30/323
4,995,154 A	*	2/1991	Bamber	30/147	D385,159 S	*	10/1997	Gagnon et al.	D7/650
D318,600 S	*	7/1991	Lillelund et al.	D7/643	5,845,403 A	*	12/1998	Nivin	30/147
D347,975 S	*	6/1994	Zeller	D7/645	6,105,259 A	*	8/2000	Meyers et al.	30/323
5,327,650 A	*	7/1994	Rojas	30/147	D475,242 S		6/2003	Jalet		
D351,085 S		10/1994	Schmidt			D479,674 S		9/2003	Freed		
5,372,650 A		12/1994	Lahoda et al.			D509,708 S	*	9/2005	Schmidt	D7/645
5,419,049 A	*	5/1995	MacArthur-Onslow	30/322	7,013,568 B1	*	3/2006	Schmidt	30/147
D362,160 S	*	9/1995	Brabeck et al.	D7/645	2005/0278958 A1	*	12/2005	Schmidt	30/324

* cited by examiner

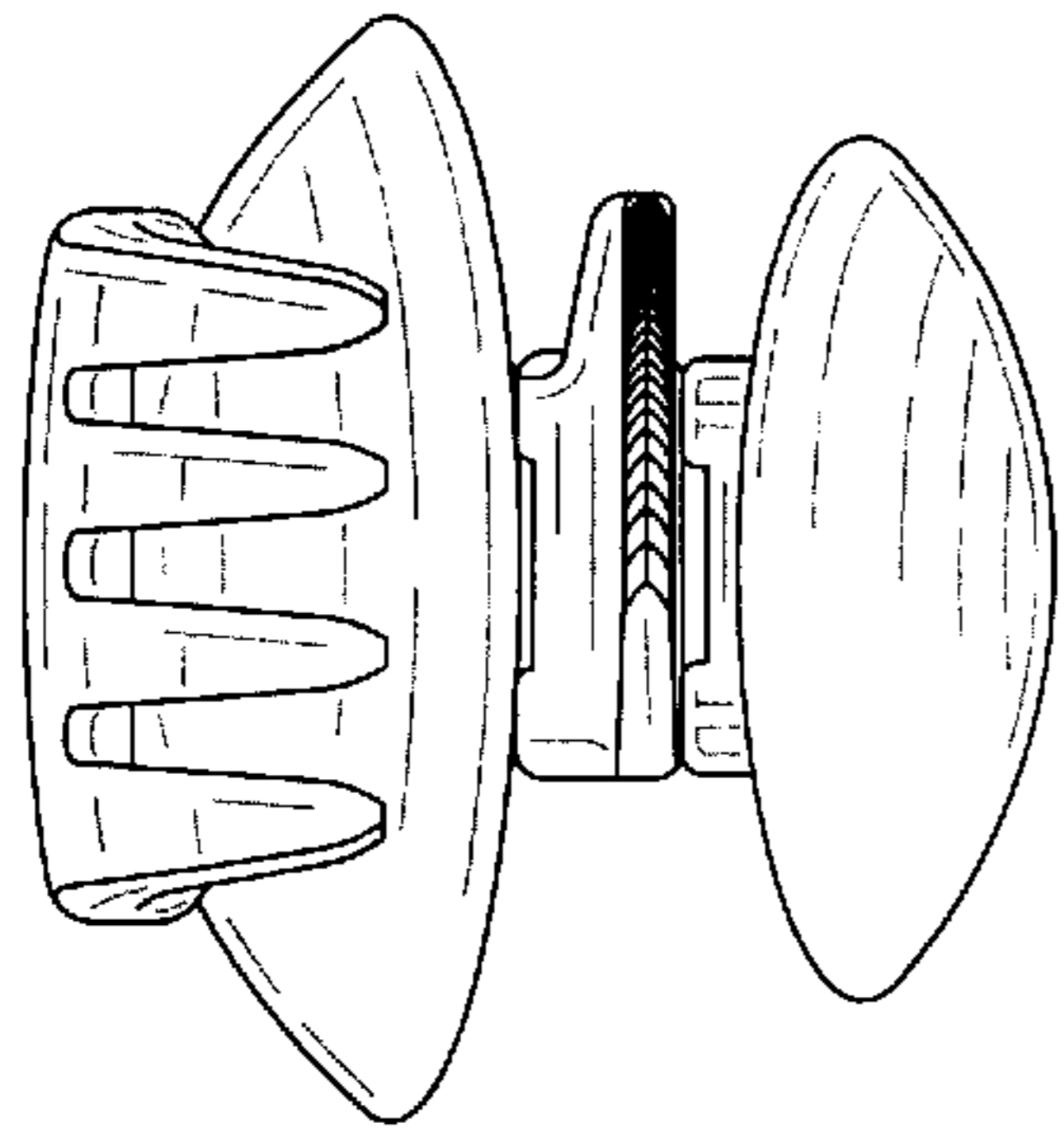

FIG. 4

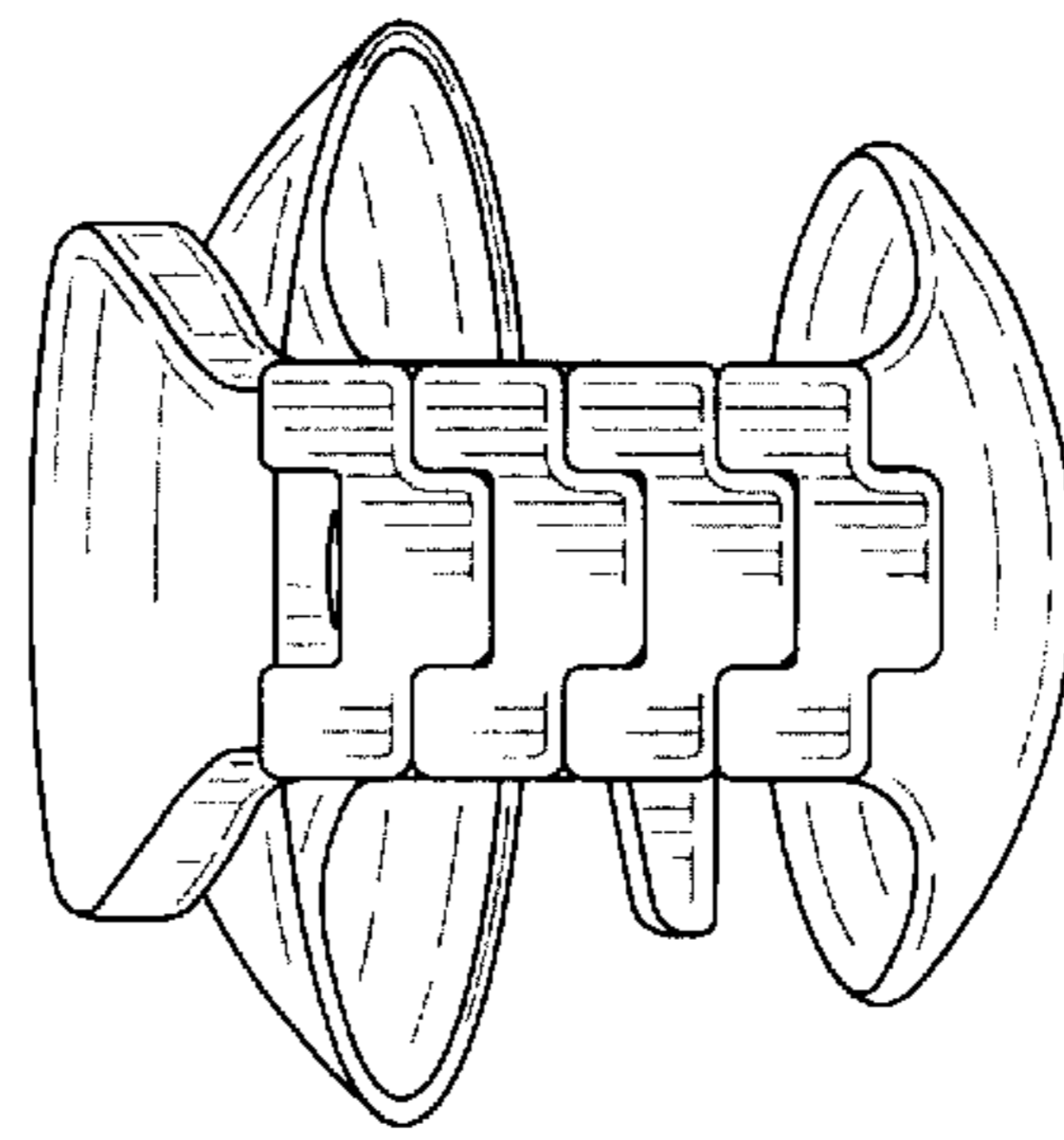

FIG. 5



FIG. 1

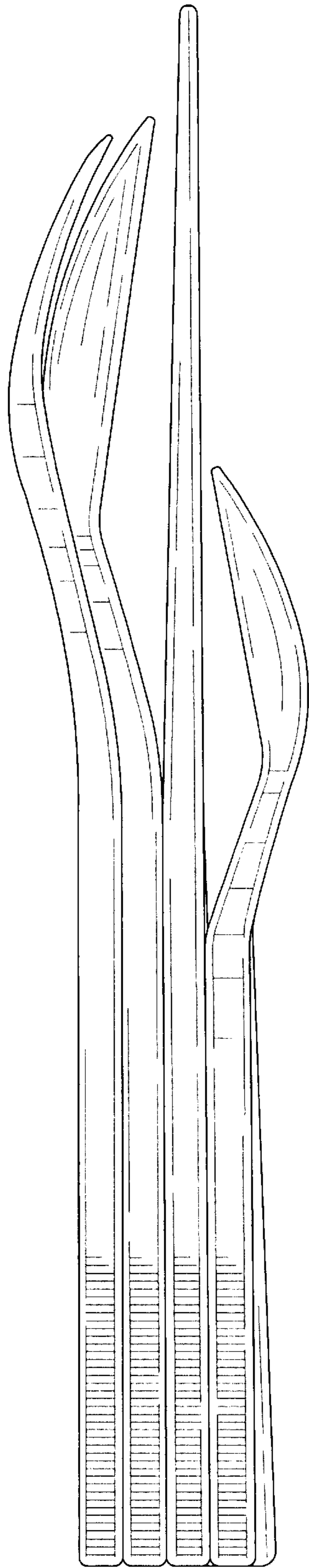

FIG. 2

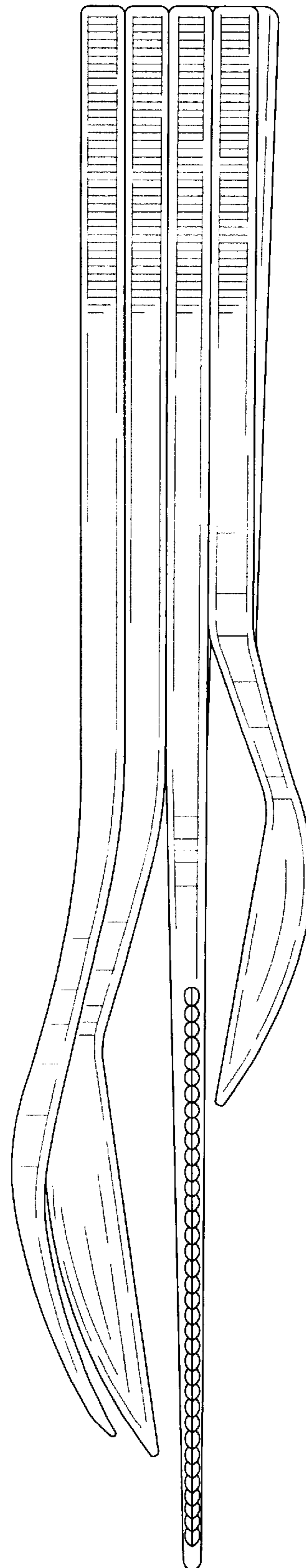

FIG. 3

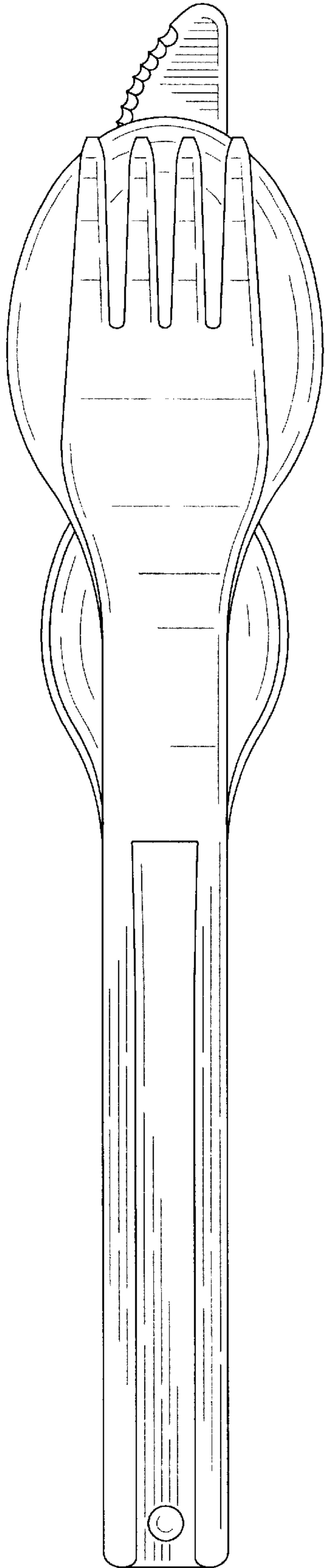

FIG. 6

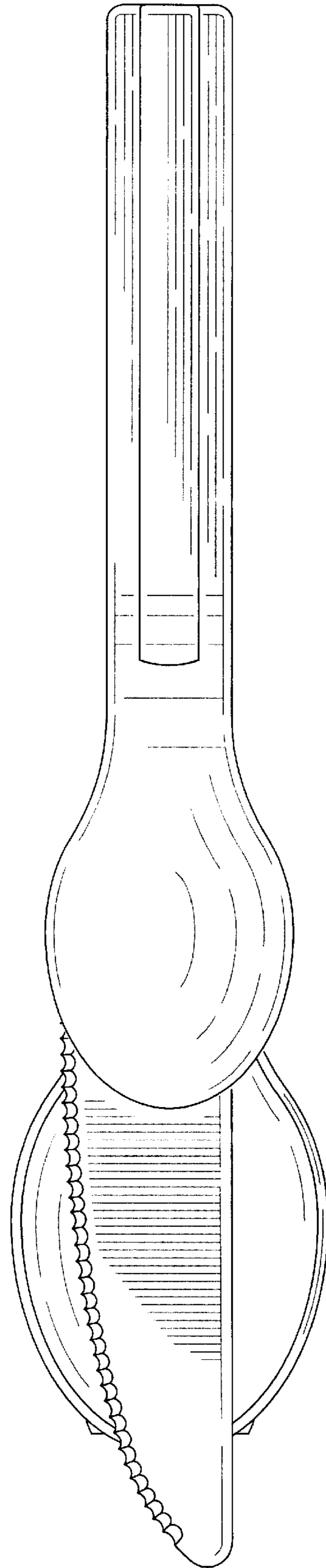

FIG. 7

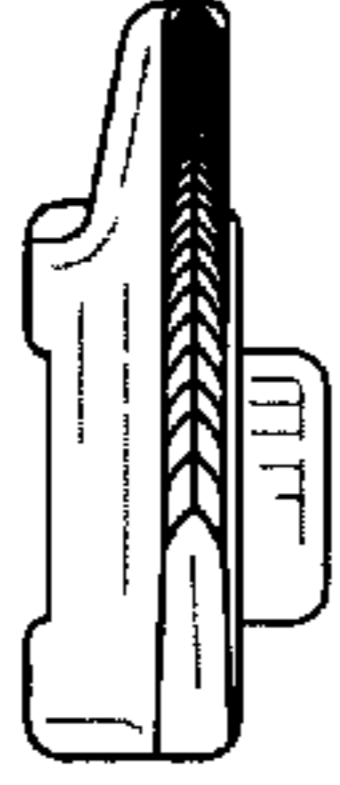

FIG. 11

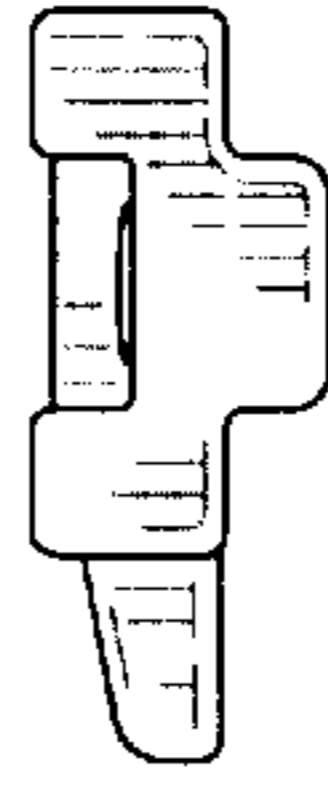

FIG. 12

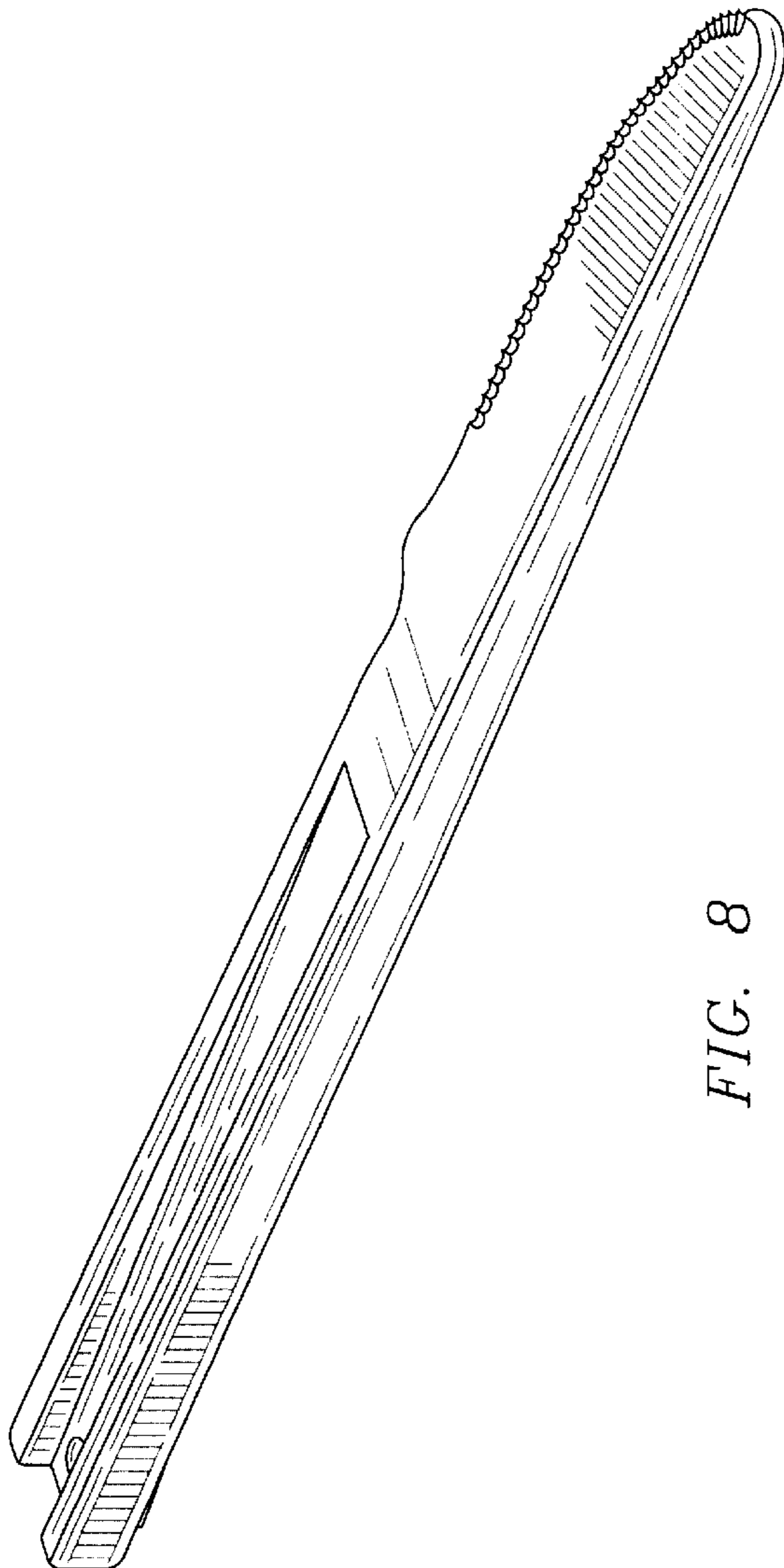

FIG. 8



FIG. 9

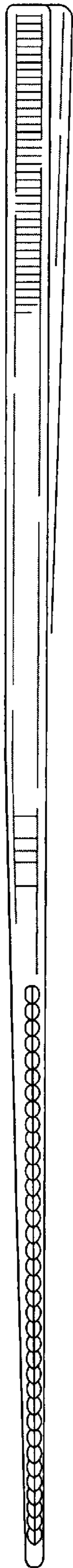

FIG. 10

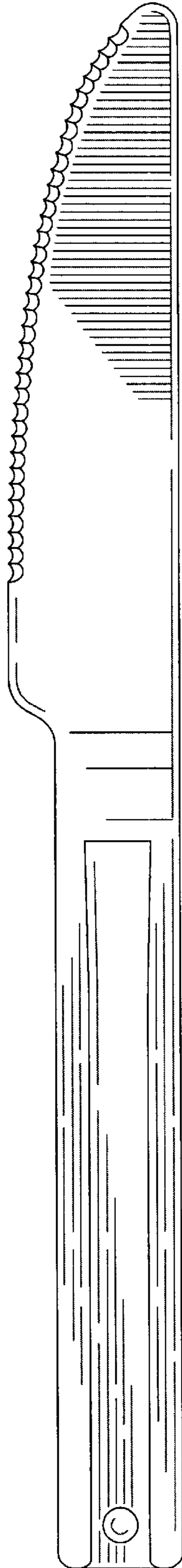

FIG. 13

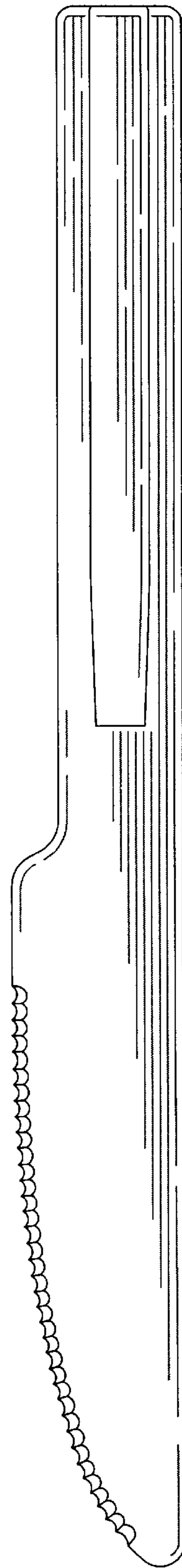

FIG. 14

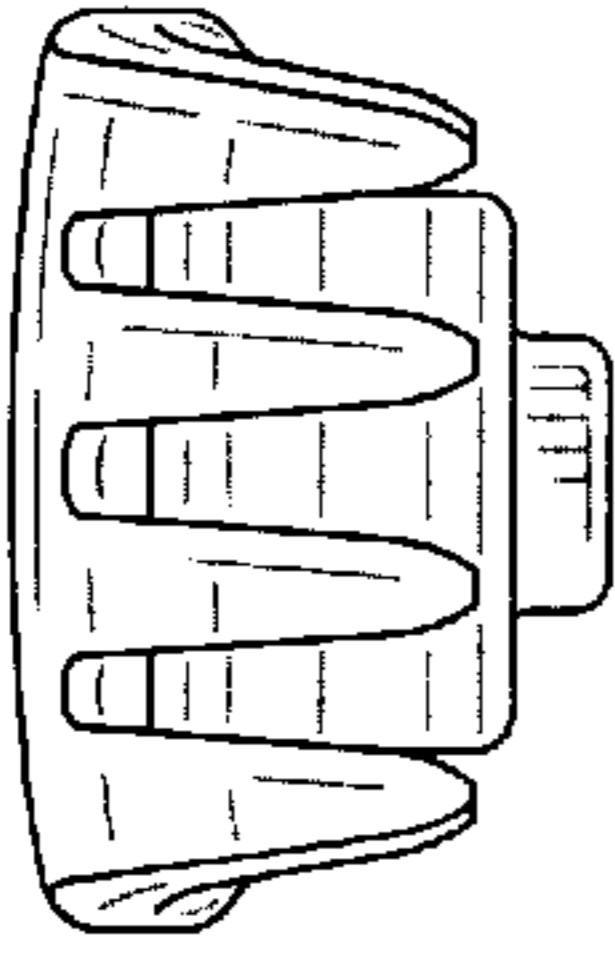

FIG. 17

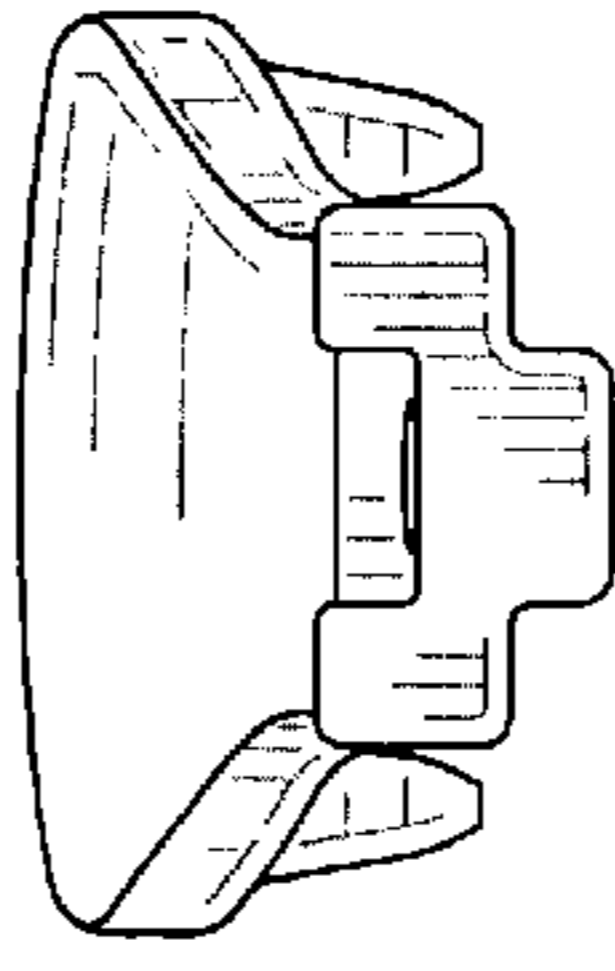

FIG. 18

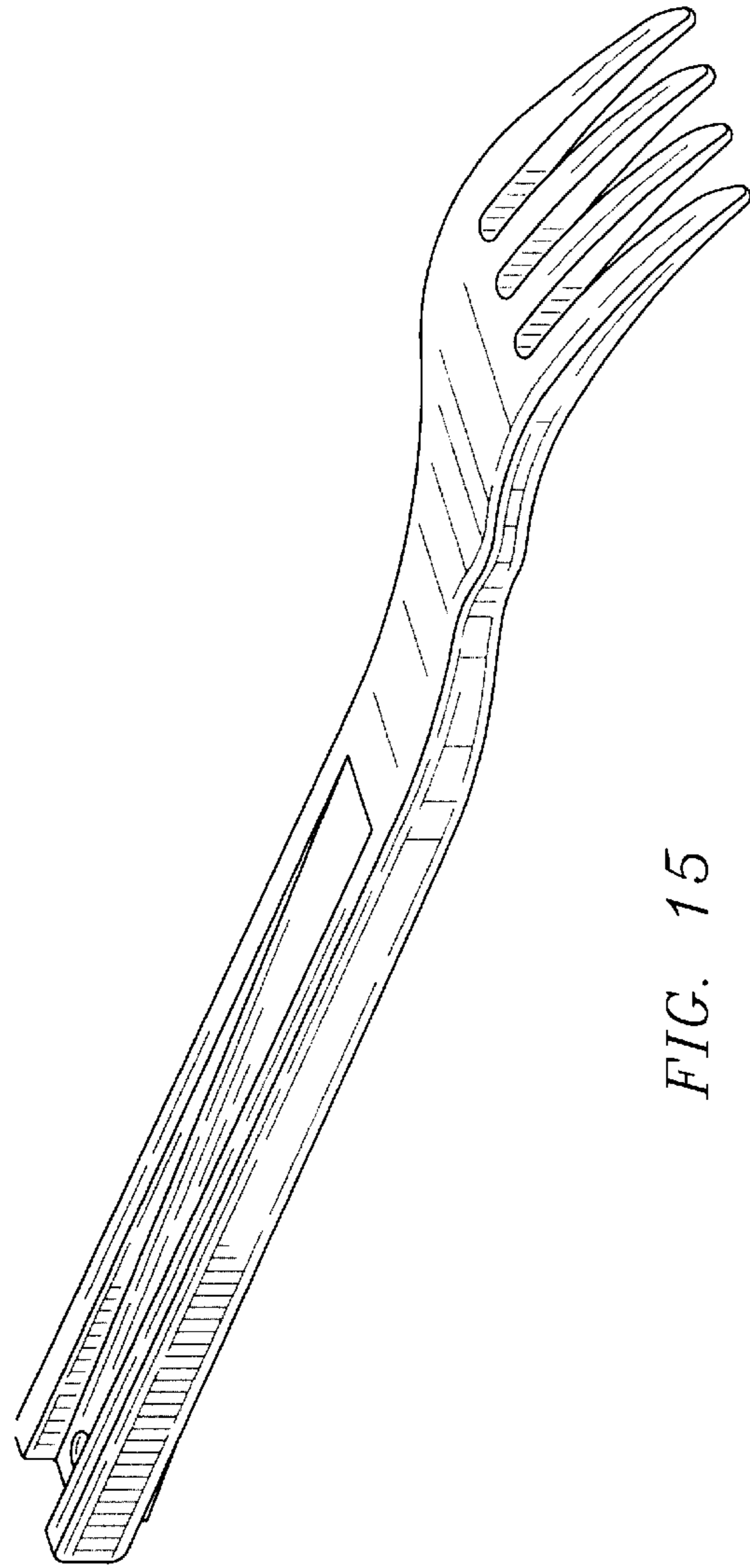

FIG. 15

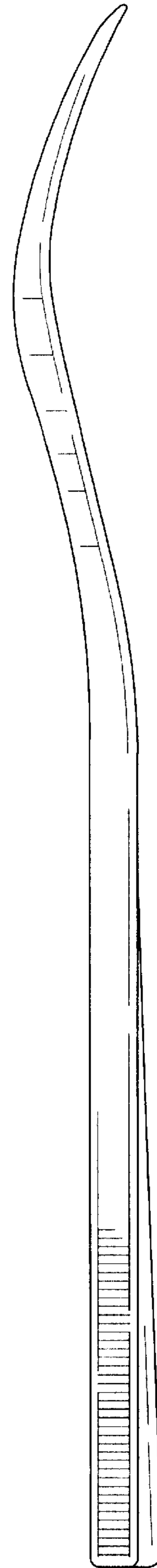

FIG. 16

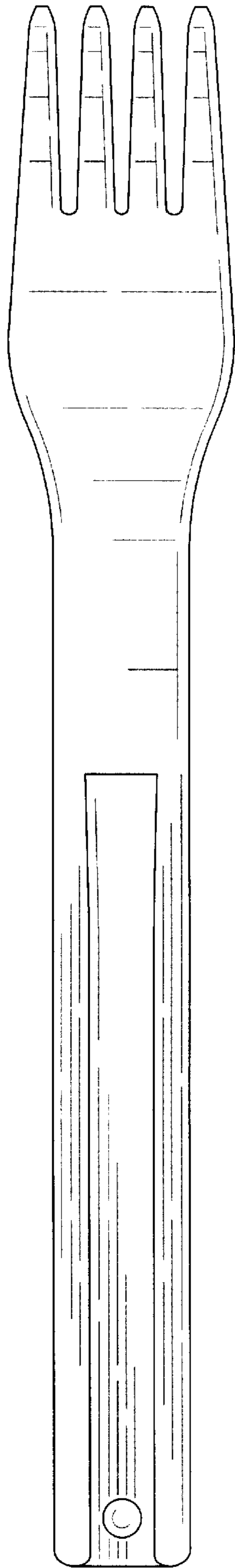

FIG. 19

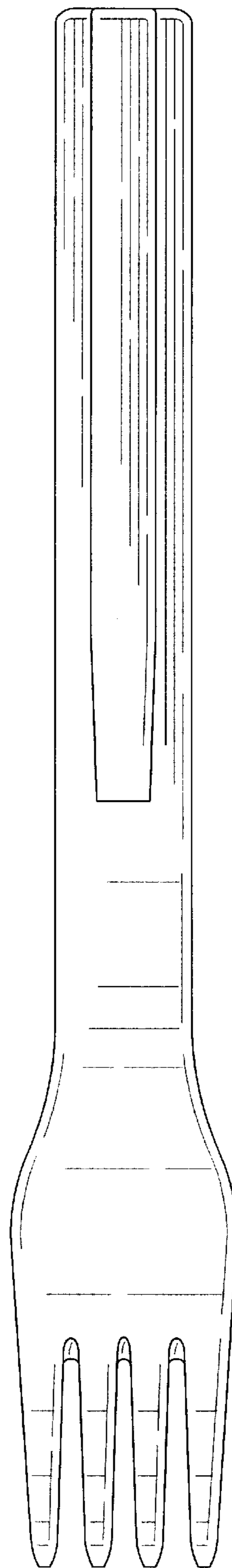

FIG. 20

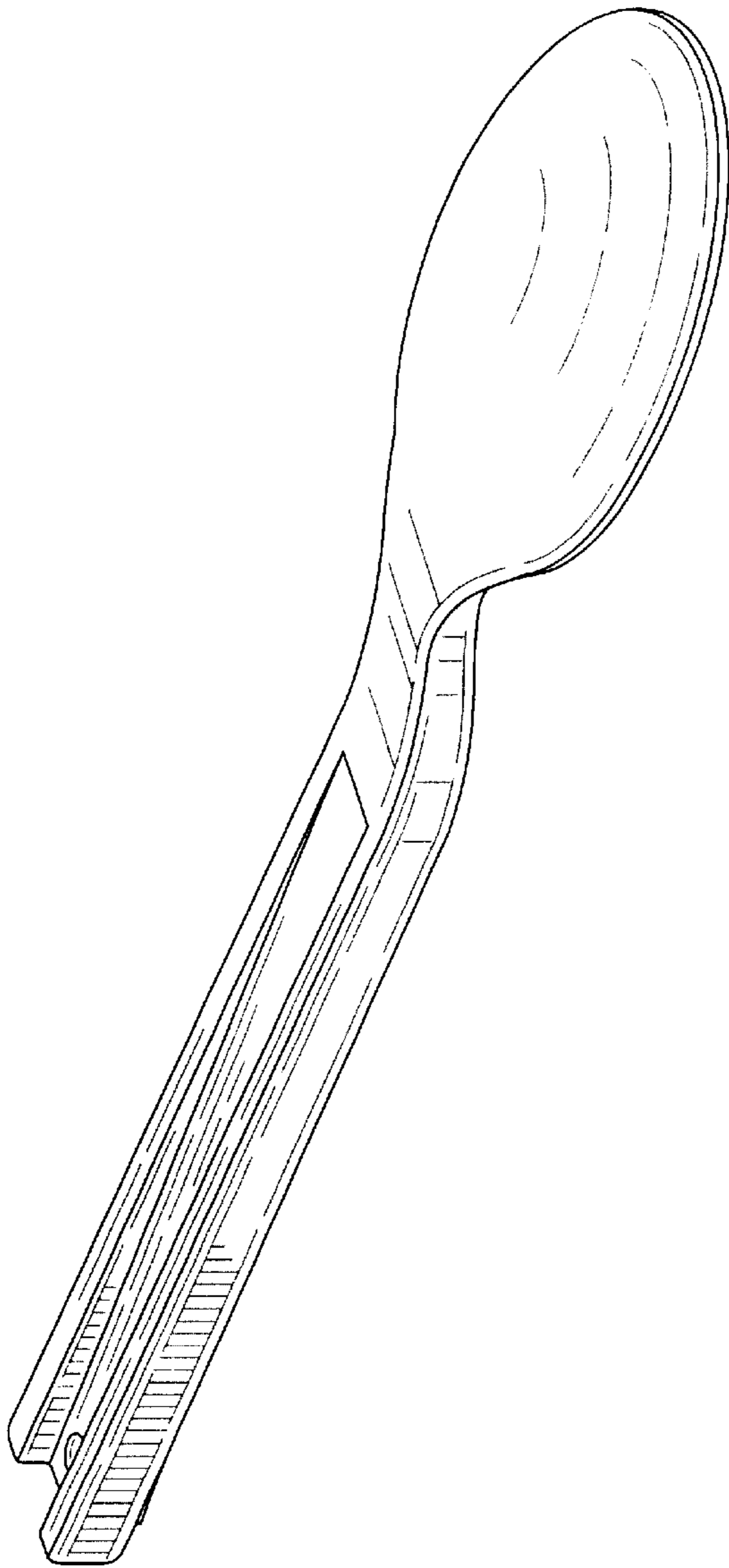

FIG. 21

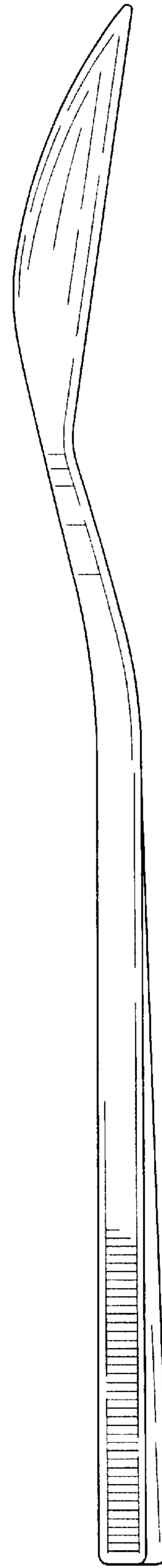

FIG. 22

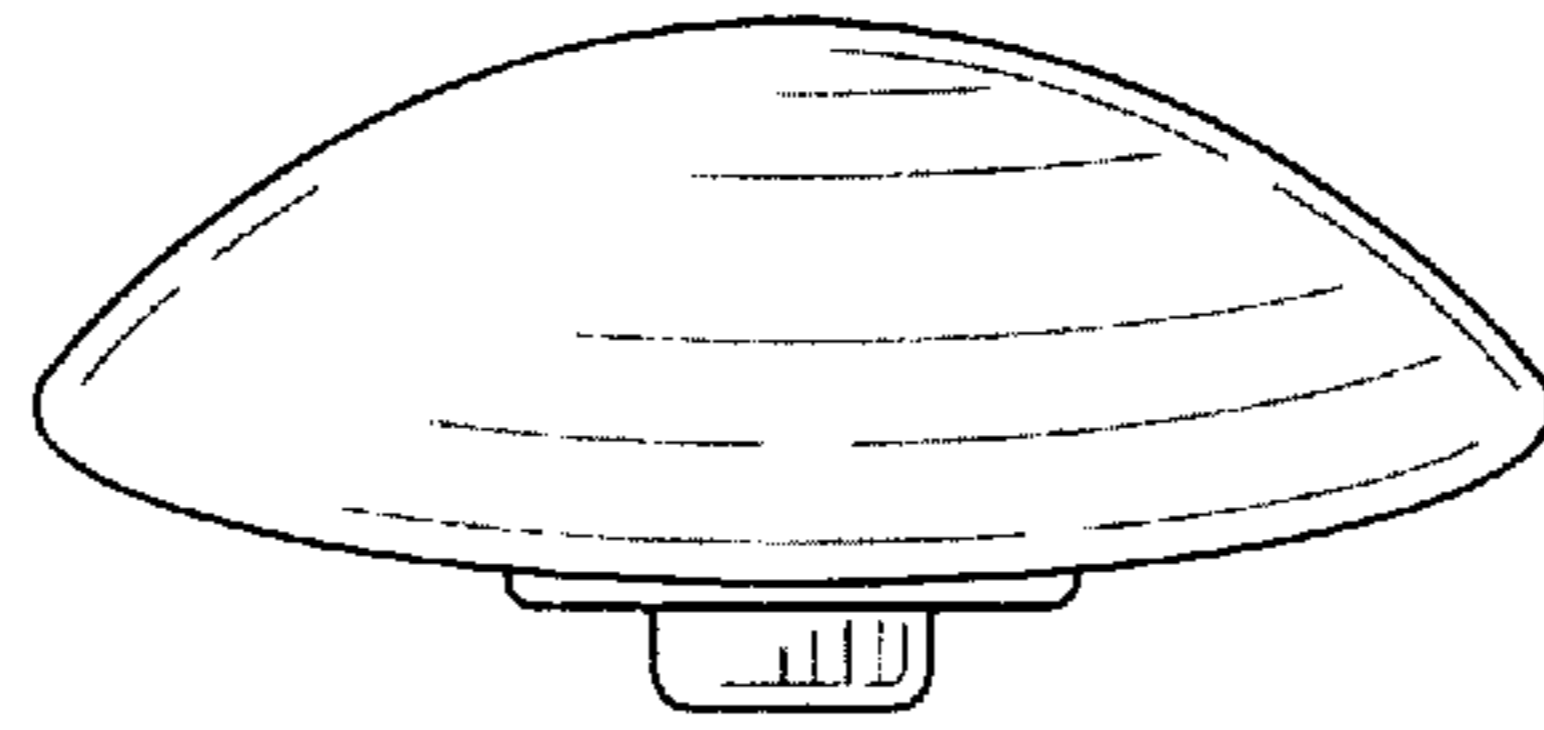

FIG. 23

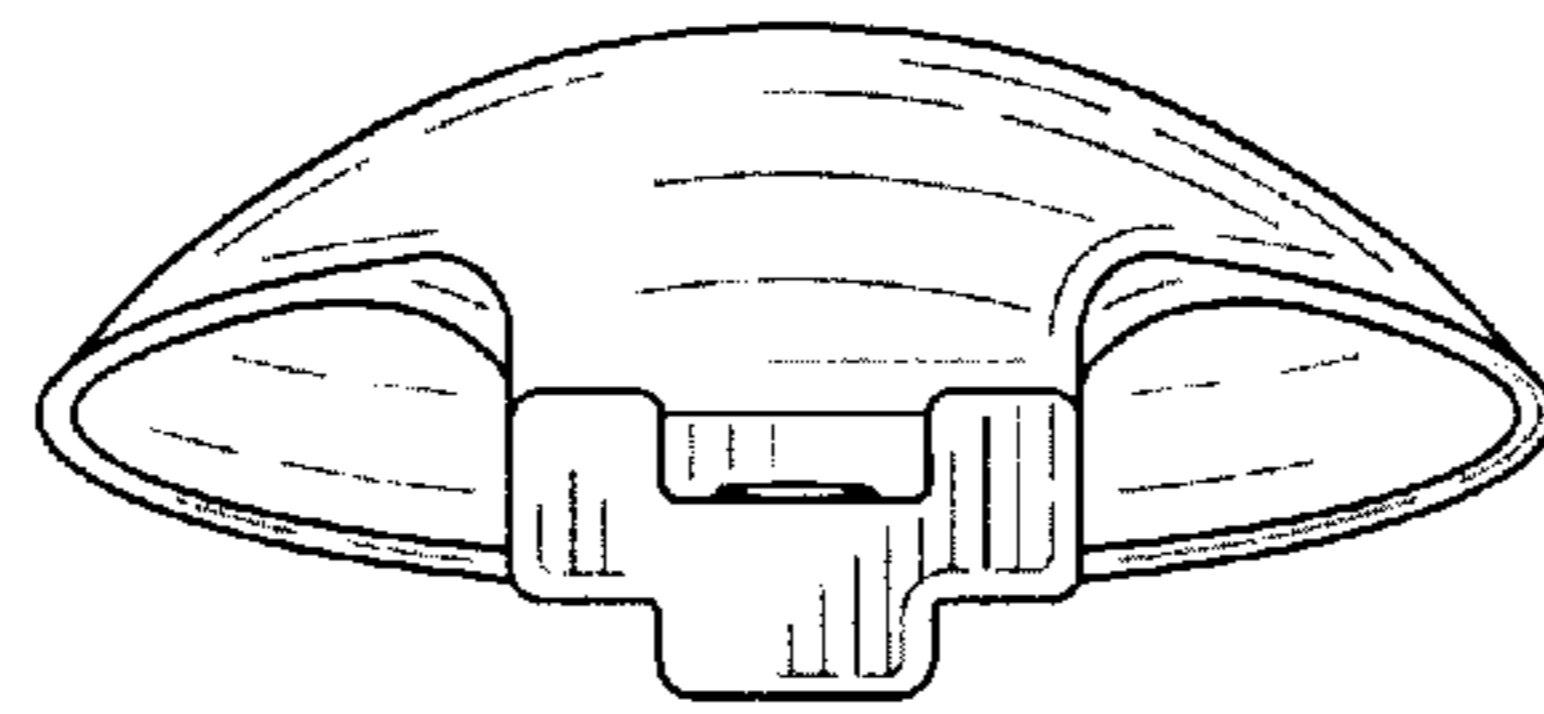

FIG. 24

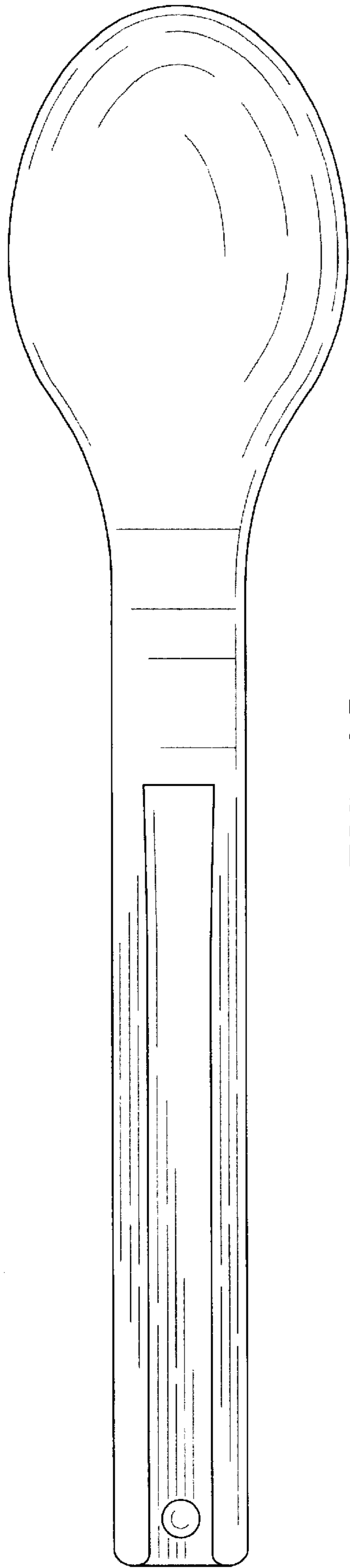

FIG. 25

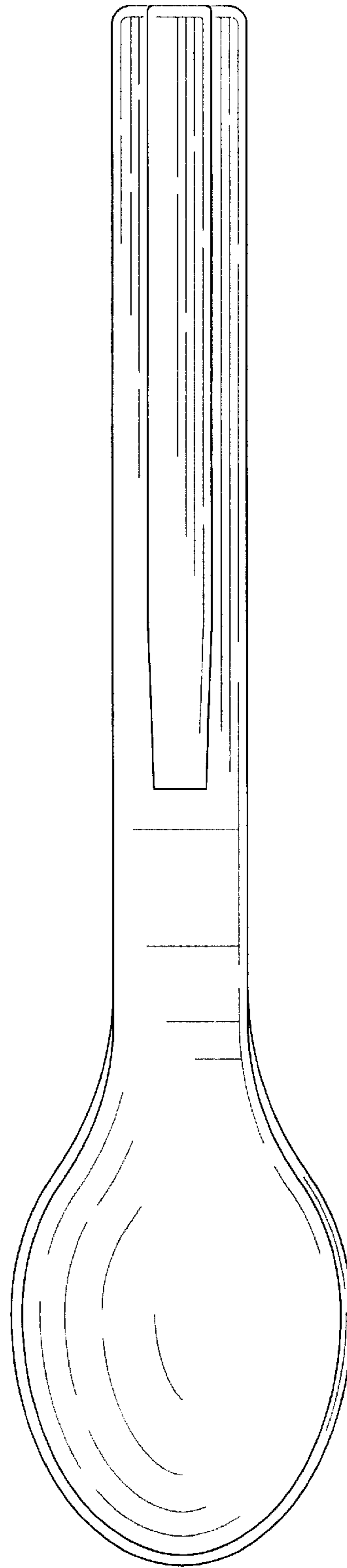

FIG. 26

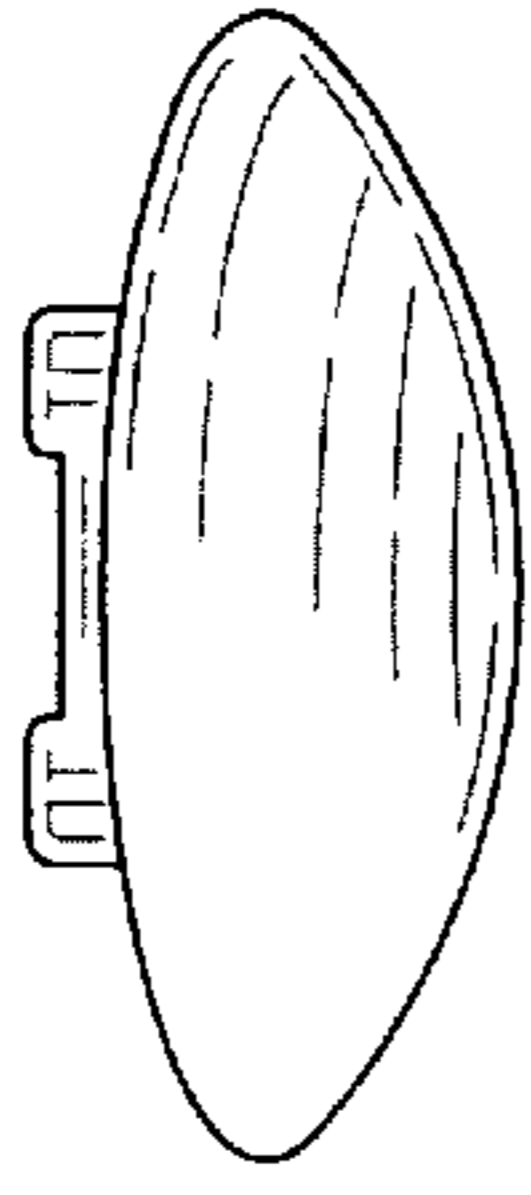

FIG. 29

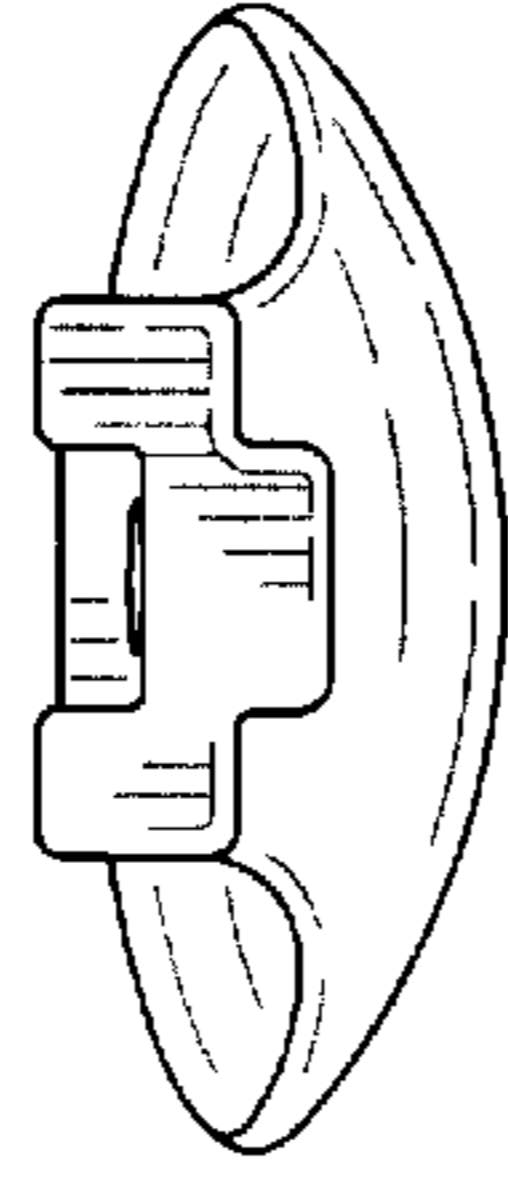

FIG. 30

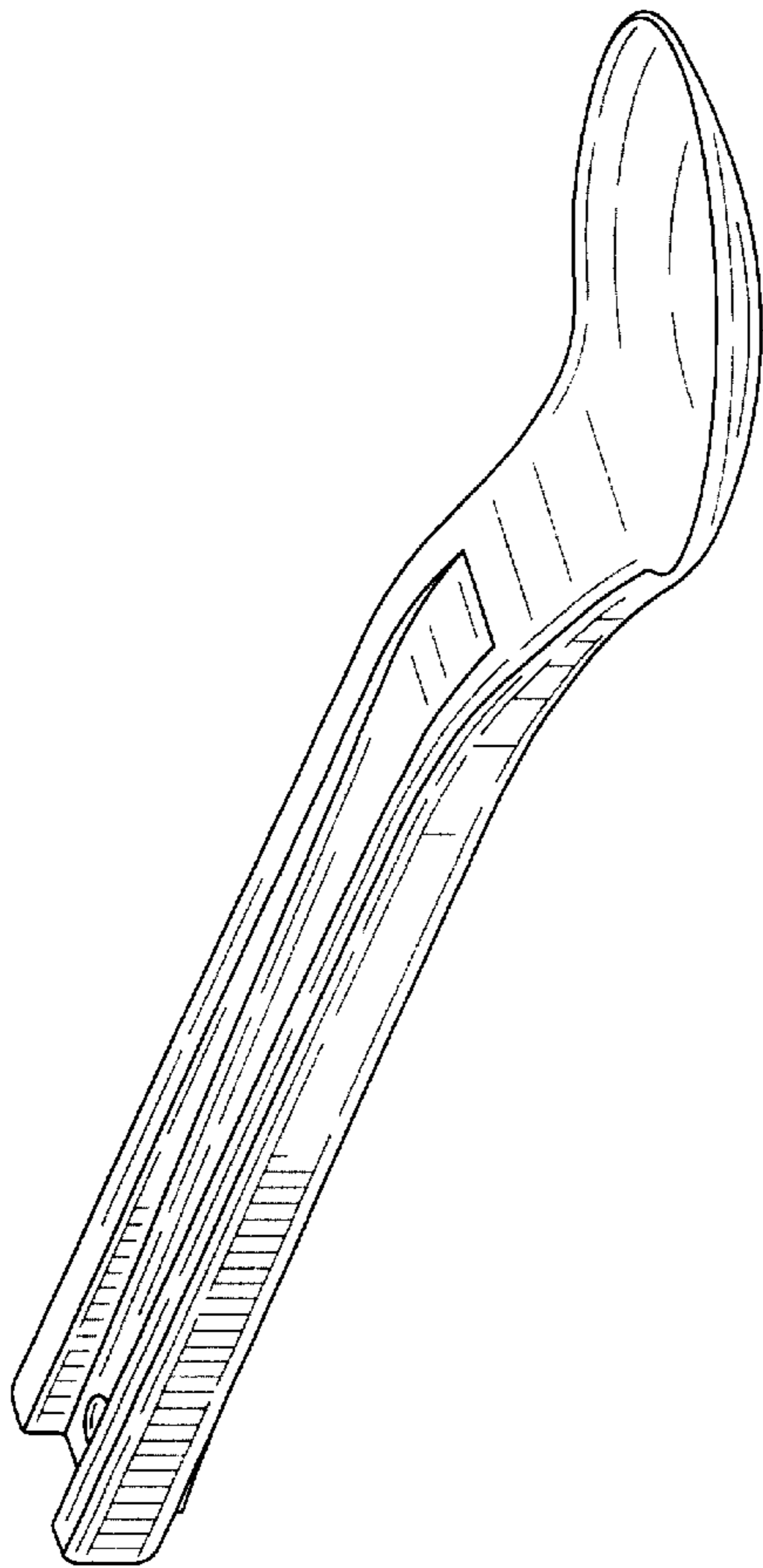

FIG. 27

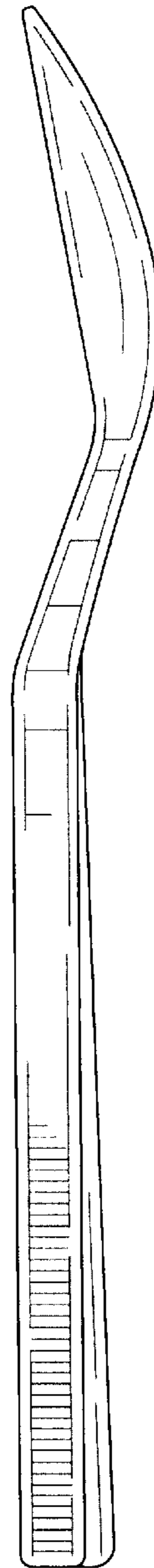

FIG. 28

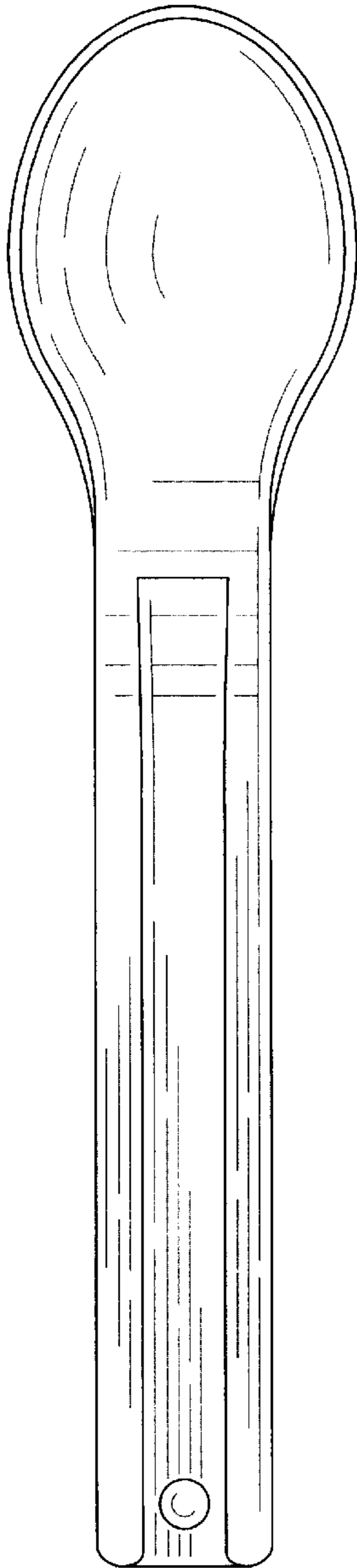

FIG. 31

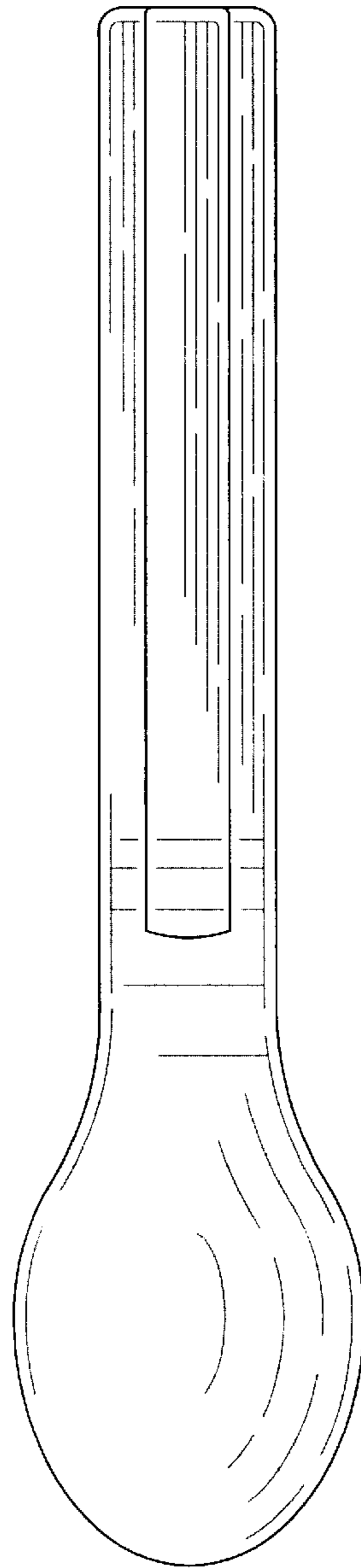

FIG. 32