



US00D536201S

(12) **United States Design Patent**
Egger

(10) **Patent No.:** **US D536,201 S**

(45) **Date of Patent:** **** Feb. 6, 2007**

(54) **SEAT AND BACK CUSHION SUPPORT FOR A CHAIR**

(75) Inventor: **Julien Egger**, Santa Monica, CA (US)

(73) Assignee: **True Seating Concepts, LLC** (MU)

(**) Term: **14 Years**

(21) Appl. No.: **29/245,780**

(22) Filed: **Dec. 30, 2005**

(51) **LOC (8) Cl.** **06-06**

(52) **U.S. Cl.** **D6/502; D6/366**

(58) **Field of Classification Search** D6/334-335,
D6/364, 365, 366, 367, 374, 491, 500-502;
248/200, 300, 629; 297/296, 297, 451.1,
297/463.1; D8/325; 16/50, 54, 61, 235
See application file for complete search history.

(56) **References Cited**

U.S. PATENT DOCUMENTS

- D155,272 S * 9/1949 Eames D6/374
- D166,893 S * 5/1952 Weill D6/374
- 4,032,190 A * 6/1977 Muller-Deisig et al. 297/285
- D256,739 S * 9/1980 Acton D6/366
- 4,790,600 A * 12/1988 Behringer 297/296
- D382,150 S * 8/1997 Balderi et al. D6/502

- D411,692 S * 6/1999 Ogg D6/366
- D515,339 S * 2/2006 Egger D6/500
- 7,008,022 B2 * 3/2006 Cassaday 297/463.1
- 2002/0140277 A1 * 10/2002 Pan 297/463.1
- 2002/0195866 A1 * 12/2002 Wu 297/463.1

* cited by examiner

Primary Examiner—Mimosa De

(74) *Attorney, Agent, or Firm*—Morland C. Fischer

(57) **CLAIM**

The ornamental design for a seat and back cushion support for a chair, as shown and described.

DESCRIPTION

FIG. 1 is a rear elevational view of a seat and back cushion support for a chair which forms my new design, the broken lines of a chair being for illustrative purposes only and forming no part of my design;

FIG. 2 is a perspective view showing the top, left side and front thereof;

FIG. 3 is a right side elevational view thereof;

FIG. 4 is a left side elevational view thereof;

FIG. 5 is a front elevational view thereof;

FIG. 6 is a rear elevational view thereof;

FIG. 7 is a top plan view thereof; and,

FIG. 8 is a bottom plan view thereof.

1 Claim, 8 Drawing Sheets

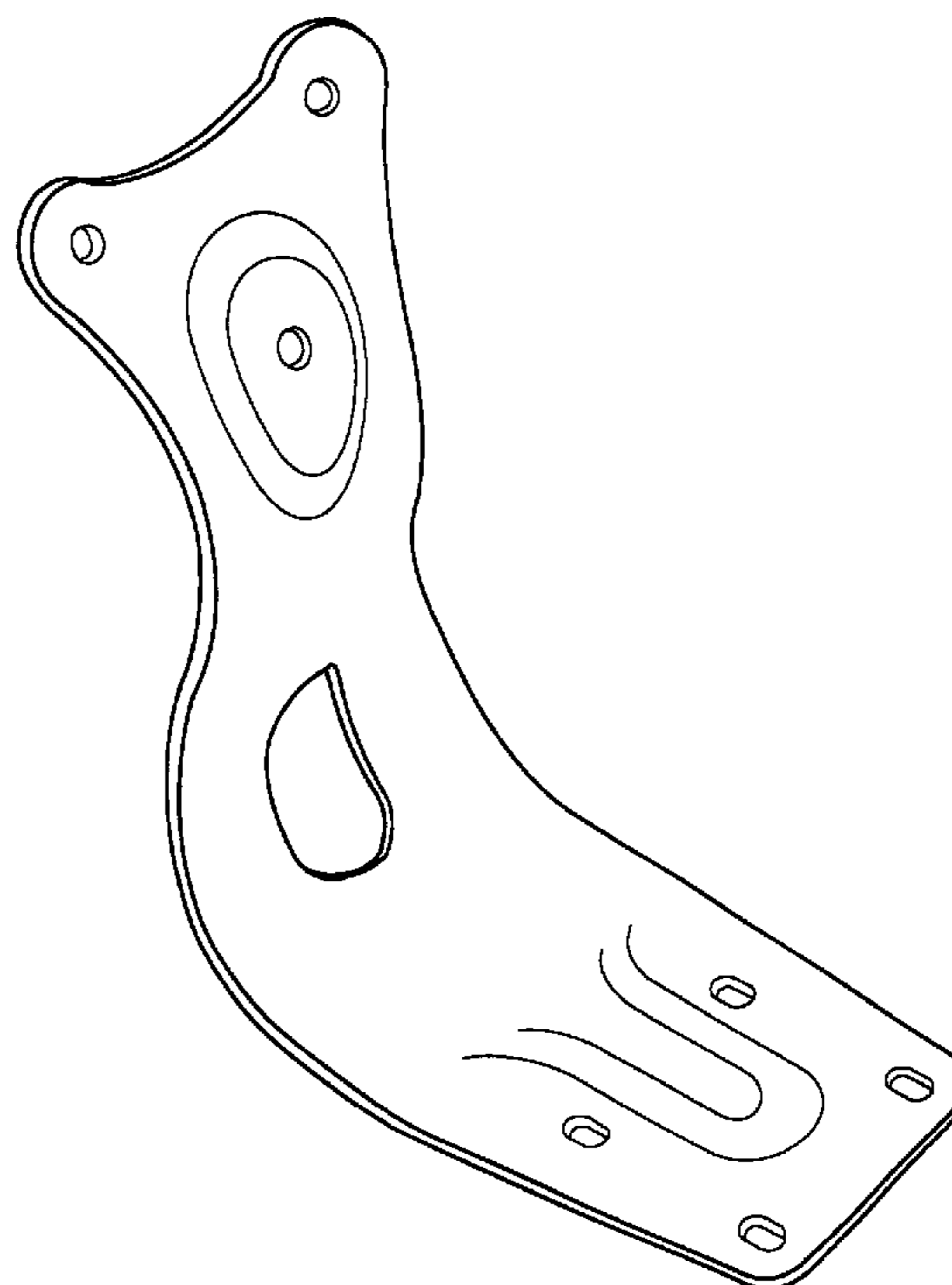
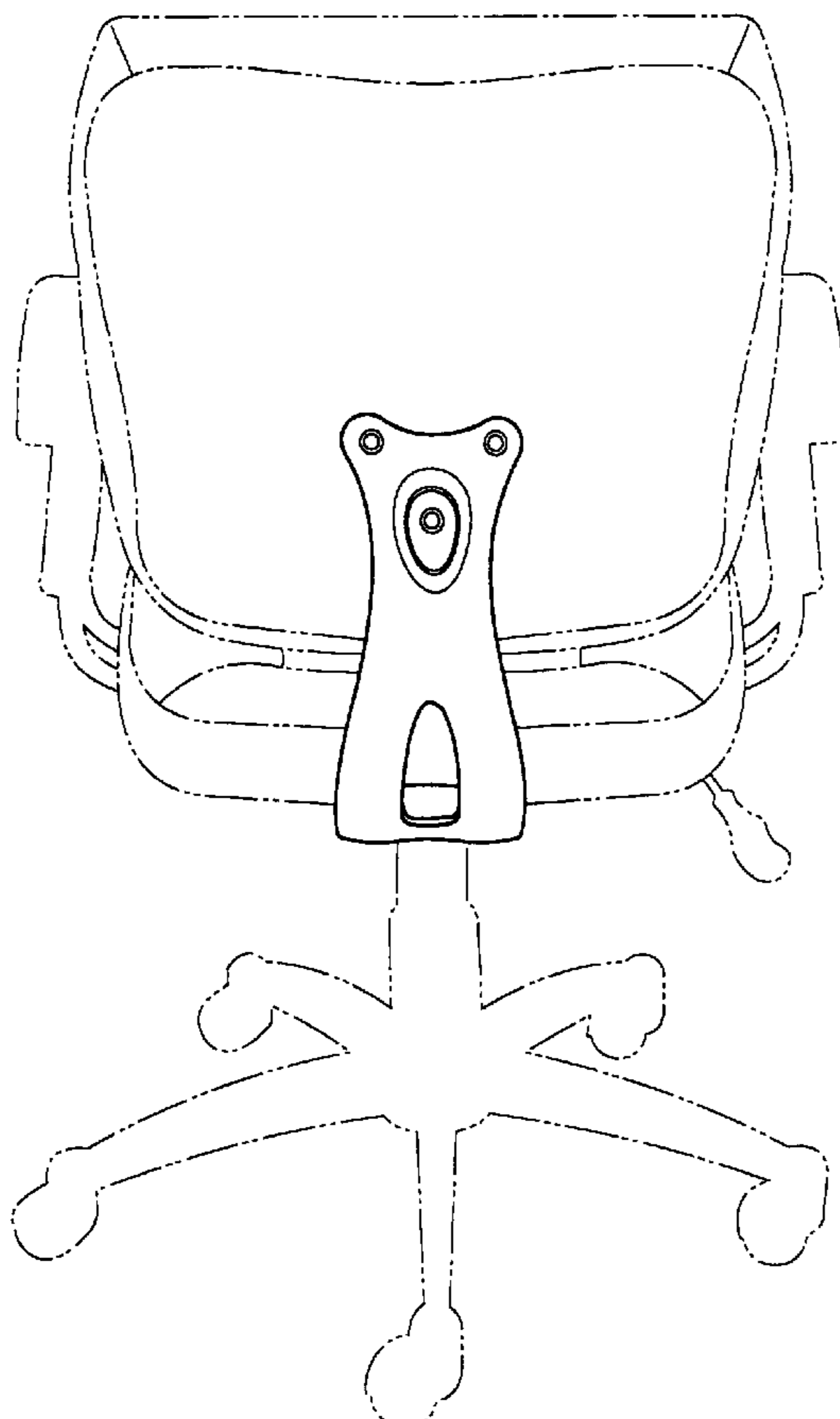

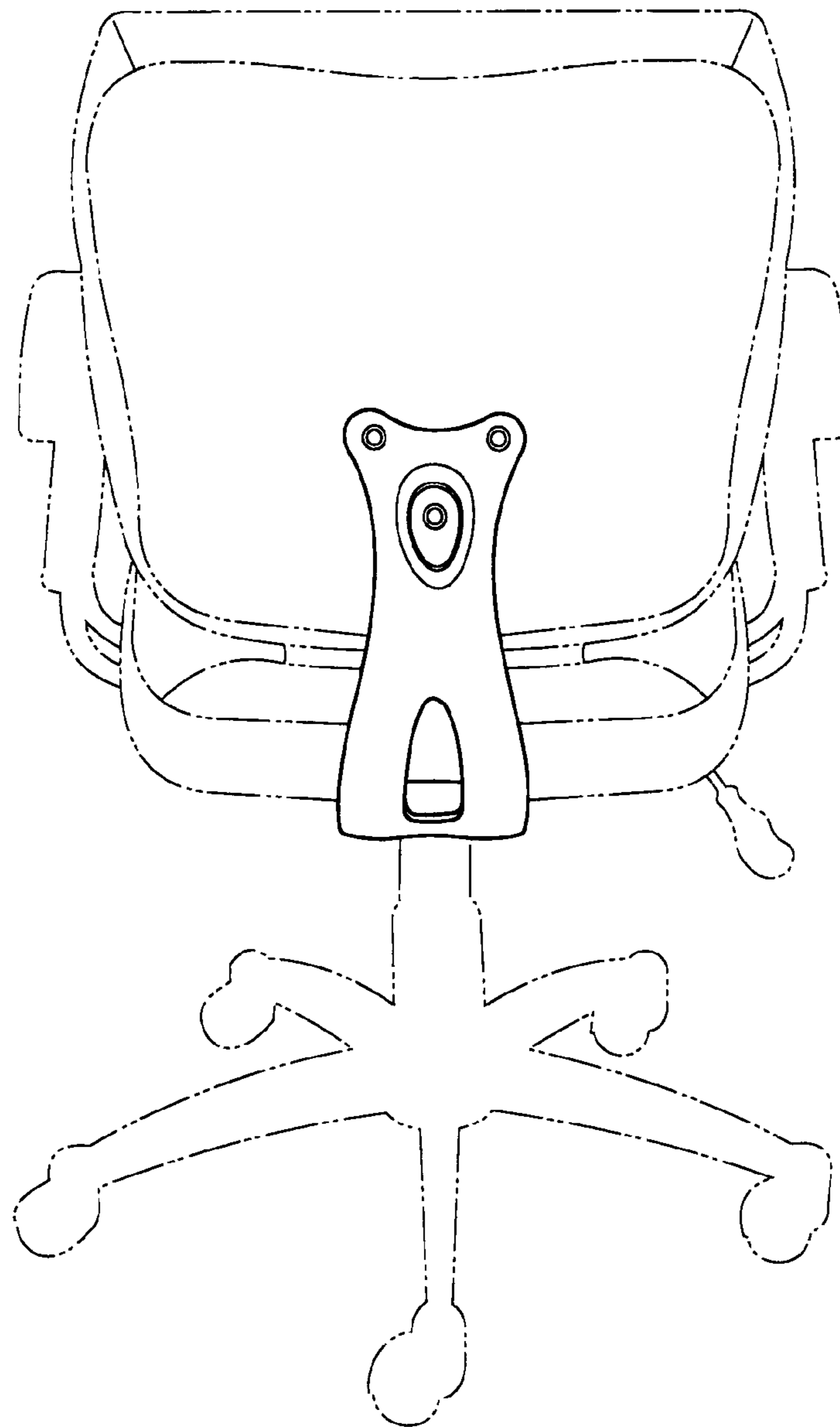

FIG. 1

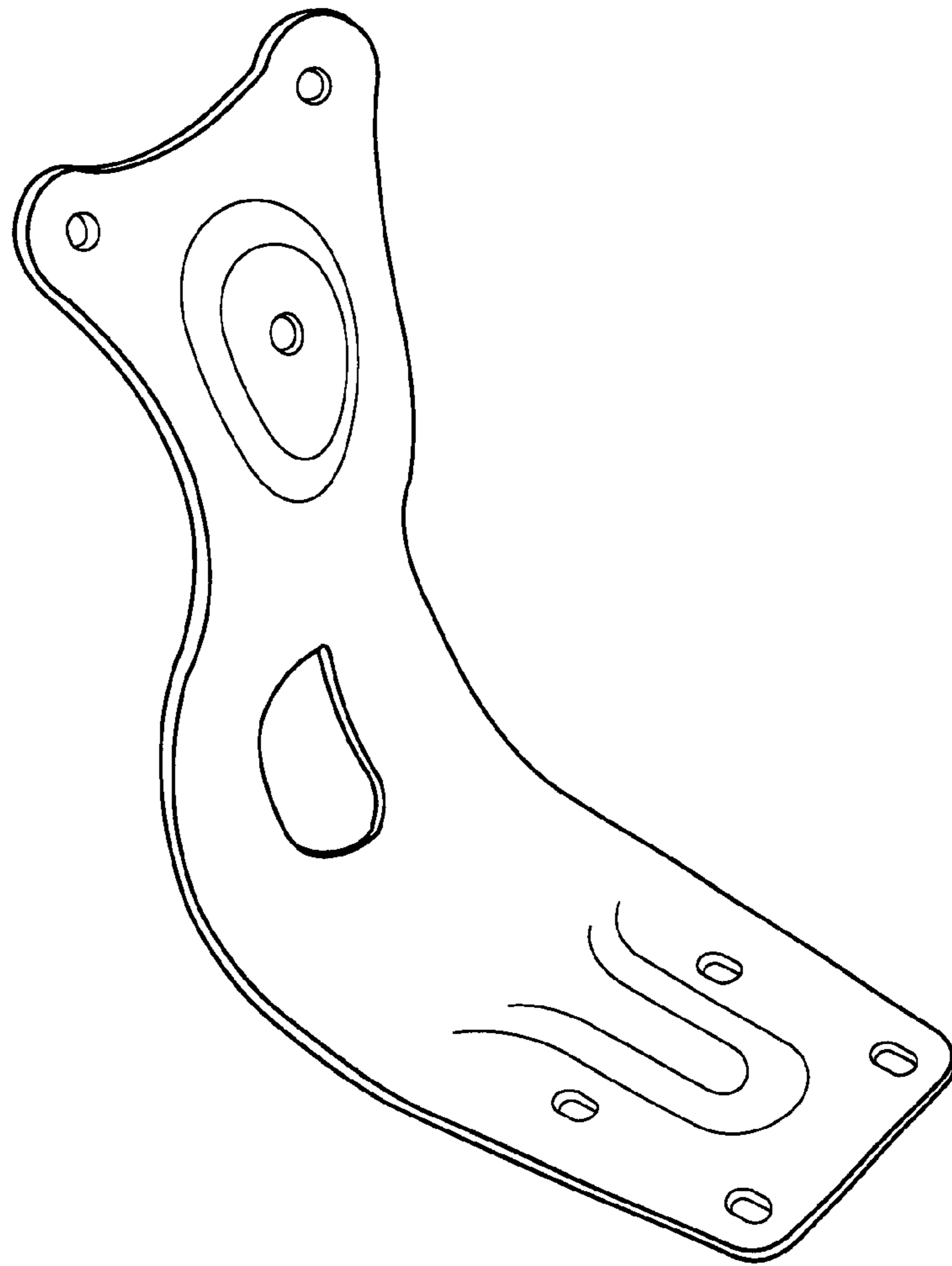

FIG. 2

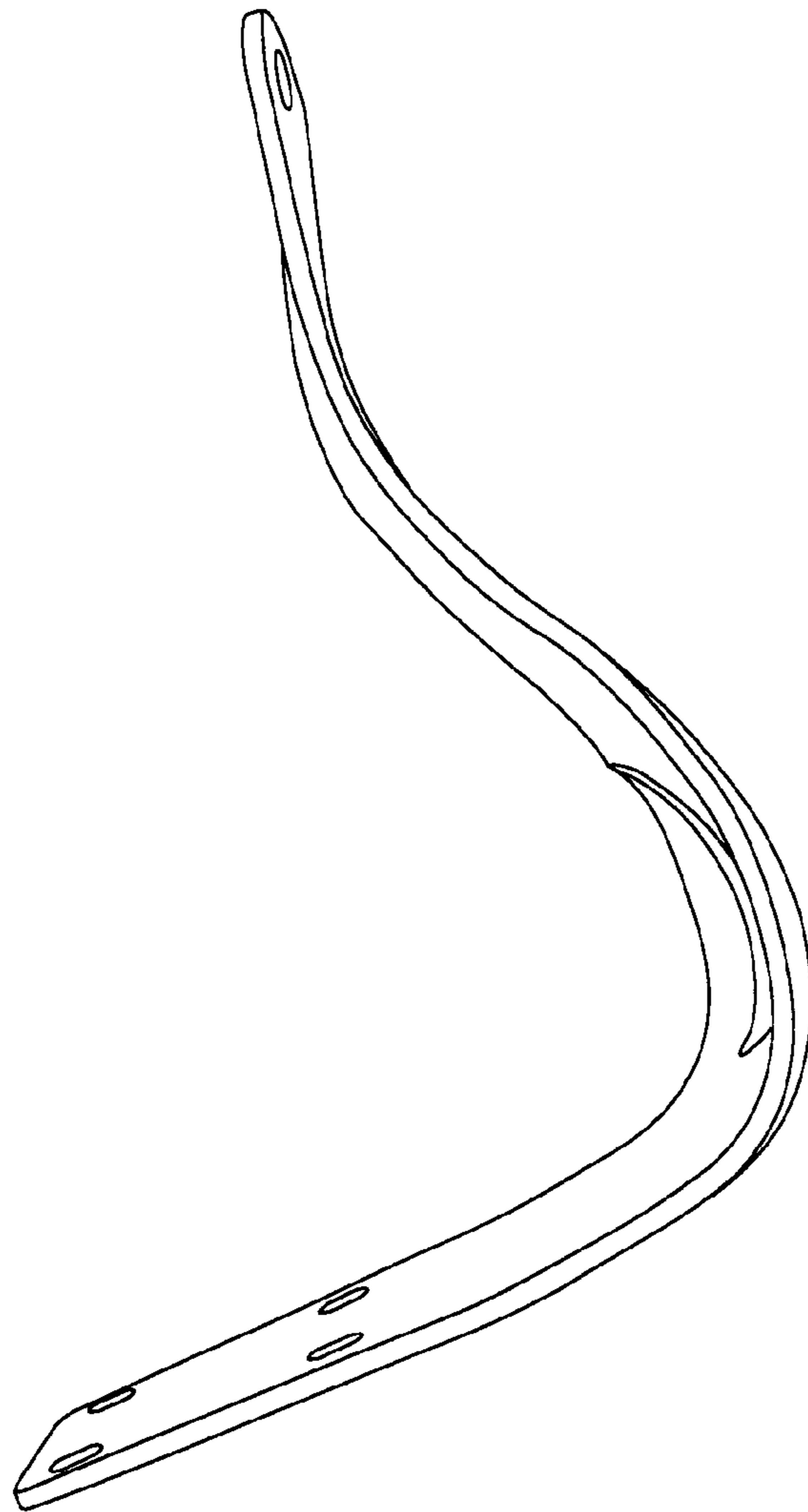

FIG. 3

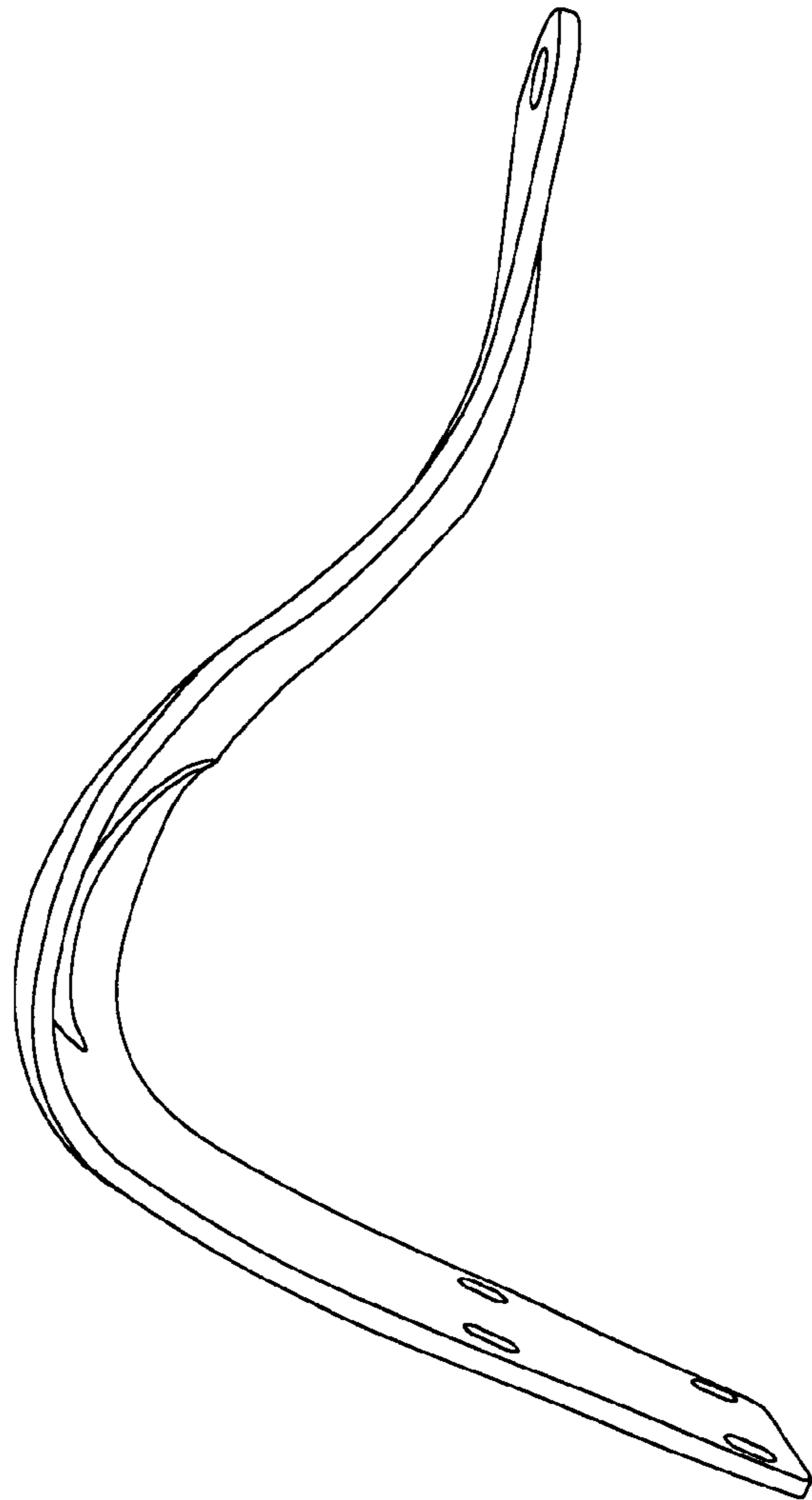

FIG. 4

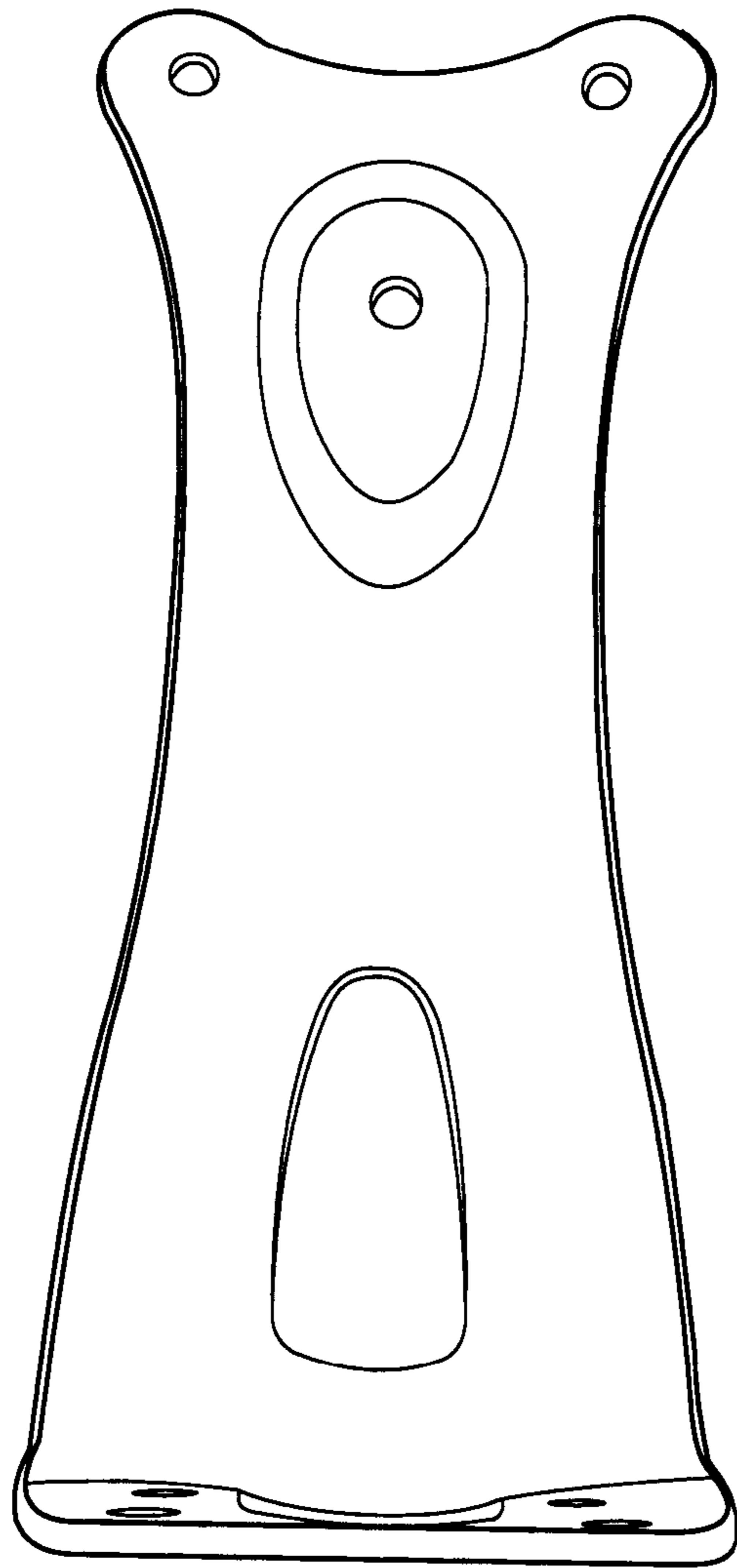

FIG. 5

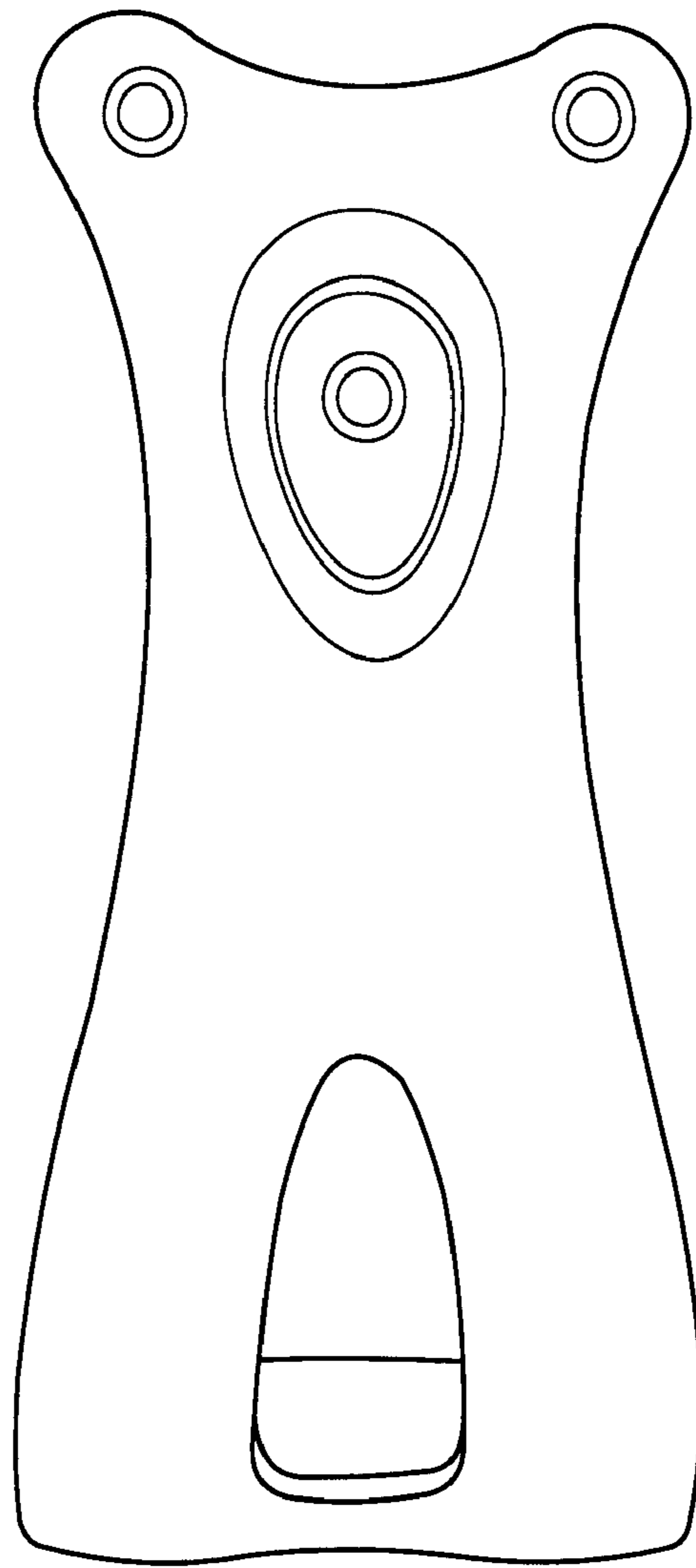

FIG. 6

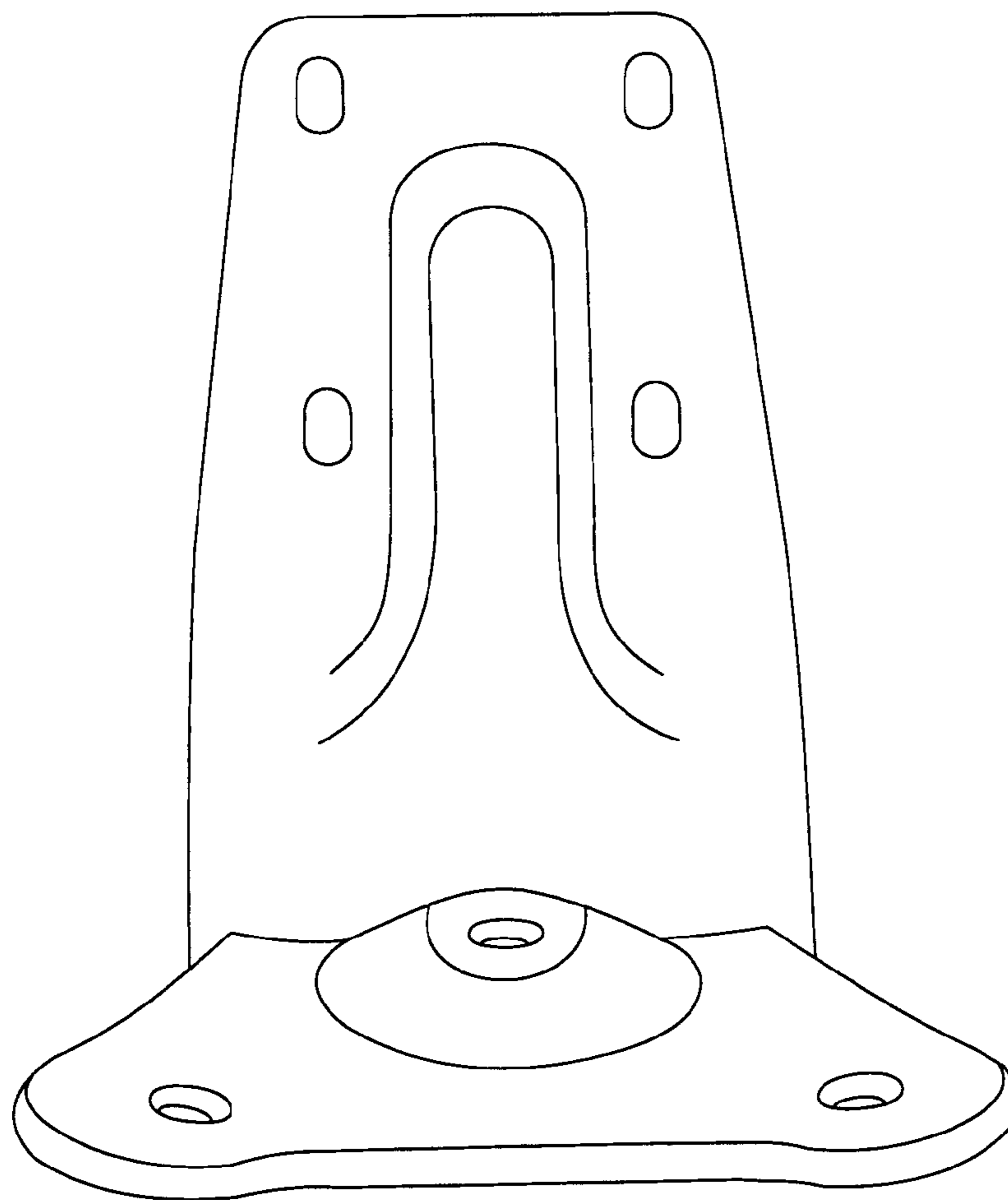

FIG. 7

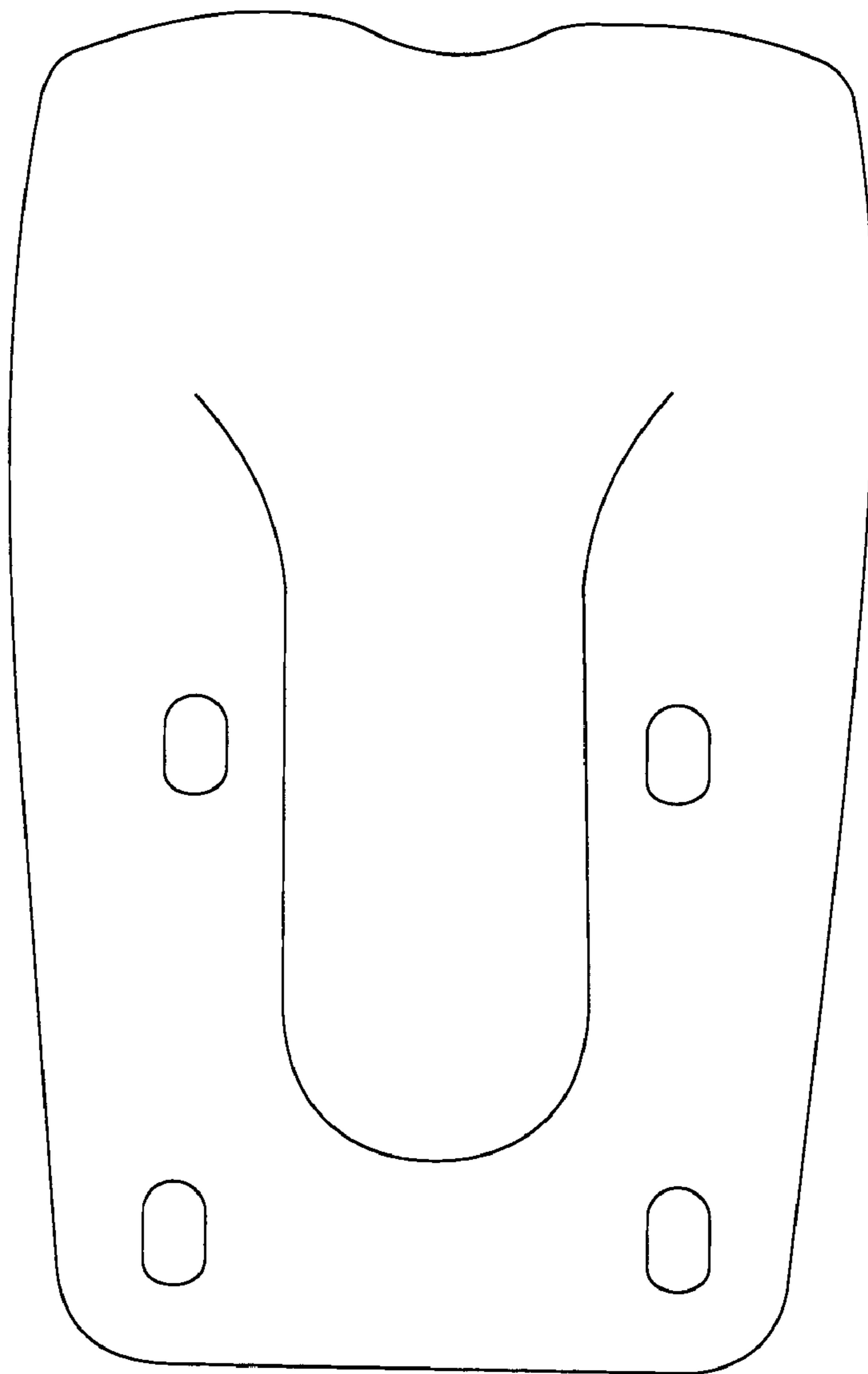

FIG. 8