



US00D535962S

(12) **United States Design Patent**
Yun et al.

(10) **Patent No.:** **US D535,962 S**
(45) **Date of Patent:** **** Jan. 30, 2007**

(54) **PORTABLE PHONE**

(75) Inventors: **Joon-Ki Yun**, Seoul (KR);
Chang-Hwan Hwang, Goyang-si (KR);
Hyun-Seop Kim, Gunpo-Si (KR)

(73) Assignee: **Samsung Electronics Co., Ltd.**,
Suwon-si (KR)

(**) **Term:** **14 Years**

(21) Appl. No.: **29/232,781**

(22) Filed: **Jun. 24, 2005**

(30) **Foreign Application Priority Data**

Dec. 24, 2004 (KR) 30-2004-0039954

(51) **LOC (8) Cl.** **14-03**

(52) **U.S. Cl.** **D14/138**

(58) **Field of Classification Search** D14/191,
D14/138, 147-148, 247-248, 144, 496, 156,
D14/341-347; 379/433.01-433.13; 455/575.3,
455/566, 575.1, 556.1, 556.2, 90.3; D21/517;
D16/208

See application file for complete search history.

(56) **References Cited**

U.S. PATENT DOCUMENTS

D501,839 S	*	2/2005	Lee et al.	D14/138
D502,458 S	*	3/2005	Chung et al.	D14/138
D505,125 S	*	5/2005	Ahn et al.	D14/138
D506,738 S	*	6/2005	Kim et al.	D14/138
D508,033 S	*	8/2005	Kim et al.	D14/138
D508,239 S	*	8/2005	Kim et al.	D14/138
D508,684 S	*	8/2005	Lee et al.	D14/138
D510,078 S	*	9/2005	Lee et al.	D14/138
D510,733 S	*	10/2005	Lee et al.	D14/138
D512,038 S	*	11/2005	Kim et al.	D14/138
D512,039 S	*	11/2005	Kim et al.	D14/138
D512,394 S	*	12/2005	Kim et al.	D14/138
D512,397 S	*	12/2005	Choi et al.	D14/138
D515,061 S	*	2/2006	Kim et al.	D14/138
D518,014 S	*	3/2006	Cho	D14/138
D518,015 S	*	3/2006	Cho	D14/138

D518,463 S	*	4/2006	Tan et al.	D14/138
D518,466 S	*	4/2006	Kim et al.	D14/138
D518,808 S	*	4/2006	Lee	D14/138

(Continued)

FOREIGN PATENT DOCUMENTS

JP	1174907	*	6/2003
JP	1188710	*	10/2003

OTHER PUBLICATIONS

Samsung D730 telephone, announced 1st quarter 2005, [online], [retrieved on Aug. 29, 2006]. Retrieved from Internet ,<URL: http://www.gsmarena.com>.*

Samsung Z330 telephone, announced Feb. 2006, [online], [retrieved on Aug. 18, 2006]. Retrieved from Internet ,<URL: http://www.gsmarena.com>.*

InnoStream INNO 78 telephone, announced 1st quarter 2004, [online], [retrieved on Aug. 29, 2006]. Retrieved from Internet ,<URL: http://www.gsmarena.com>.*

LG L342i telephone, announced 2nd quarter 2005, [online], [retrieved on Aug. 25, 2006]. Retrieved from Internet ,<URL: http://www.gsmarena.com>.*

Primary Examiner—Jeffrey Asch

(74) *Attorney, Agent, or Firm*—Staas & Halsey LLP

(57) **CLAIM**

The ornamental design for the portable phone, as shown and described.

DESCRIPTION

FIG. 1 is a perspective view of the portable phone showing our design;

FIG. 2 is a front view thereof;

FIG. 3 is a rear view thereof;

FIG. 4 is a left side view thereof;

FIG. 5 is a right side view thereof;

FIG. 6 is a top plan view thereof; and,

FIG. 7 is a bottom plan view thereof.

1 Claim, 4 Drawing Sheets

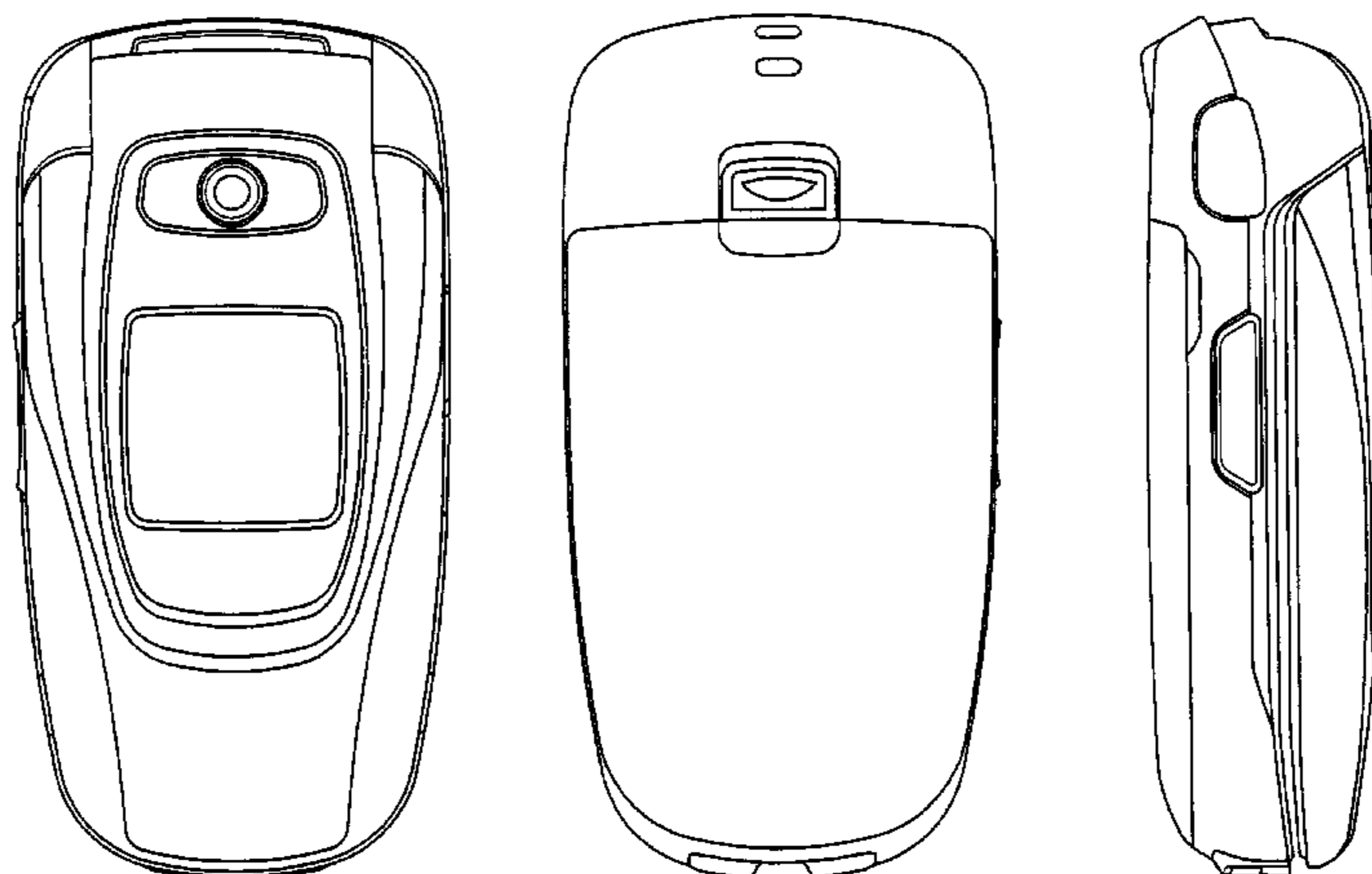

US D535,962 S

Page 2

U.S. PATENT DOCUMENTS

D518,809 S	*	4/2006	Cho	D14/138	D520,982 S	*	5/2006	Kim et al.	D14/138
D519,479 S	*	4/2006	Koo et al.	D14/138	D521,482 S	*	5/2006	Oh et al.	D14/138
D519,483 S	*	4/2006	Cho et al.	D14/138	D521,483 S	*	5/2006	Kim et al.	D14/138
D519,486 S	*	4/2006	Lee et al.	D14/138	D521,484 S	*	5/2006	Oh et al.	D14/138
D519,973 S	*	5/2006	Chung et al.	D14/138	D522,482 S	*	6/2006	Jeoung et al.	D14/138
D519,974 S	*	5/2006	Lee	D14/138	D522,991 S	*	6/2006	Yun et al.	D14/138
D520,486 S	*	5/2006	Kim et al.	D14/138	D523,411 S	*	6/2006	Kim et al.	D14/138
D520,979 S	*	5/2006	Kim et al.	D14/138	2004/0097258 A1	*	5/2004	Lee et al.	455/550.1
D520,981 S	*	5/2006	Lee et al.	D14/138						

* cited by examiner

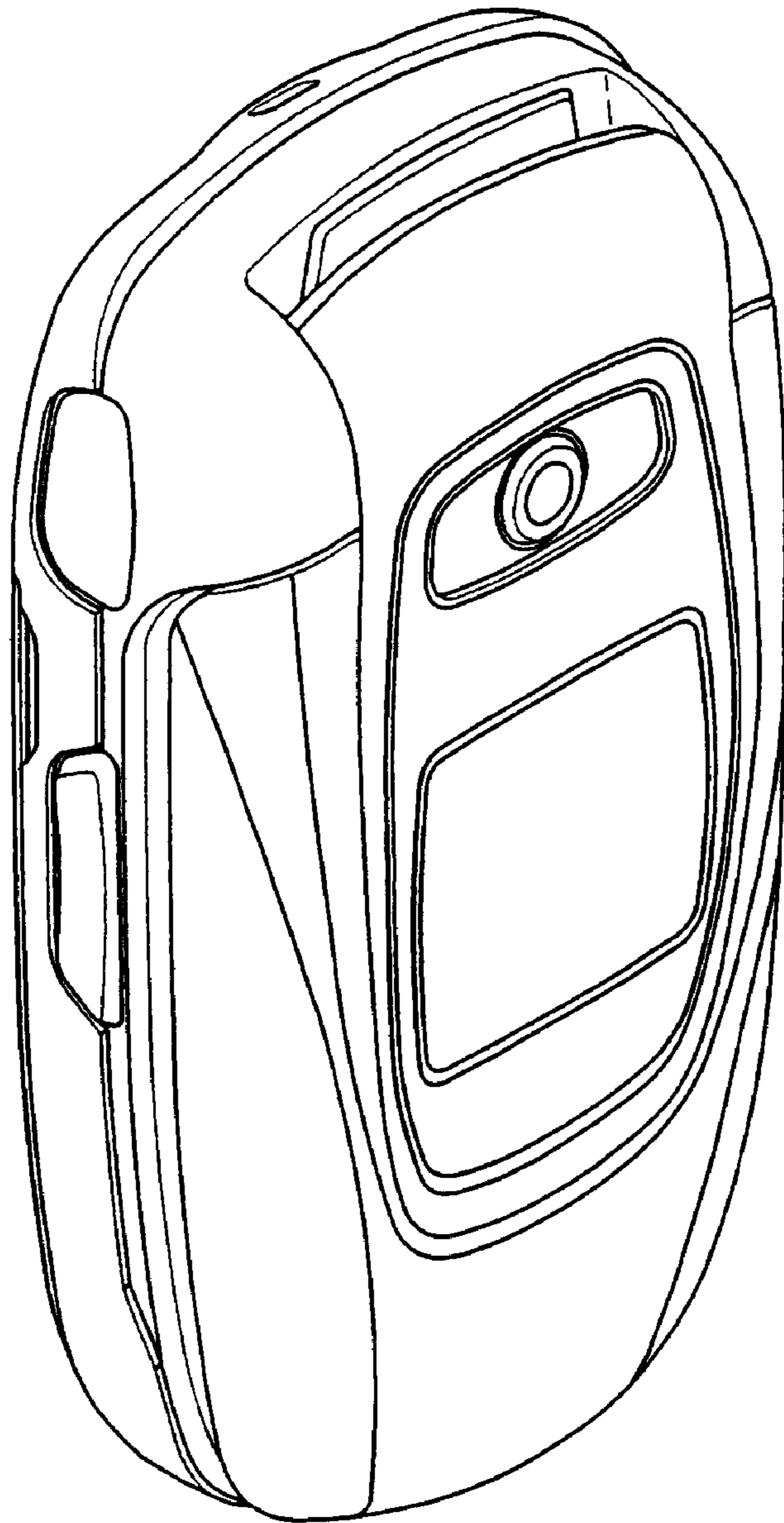

FIG. 1

FIG. 2

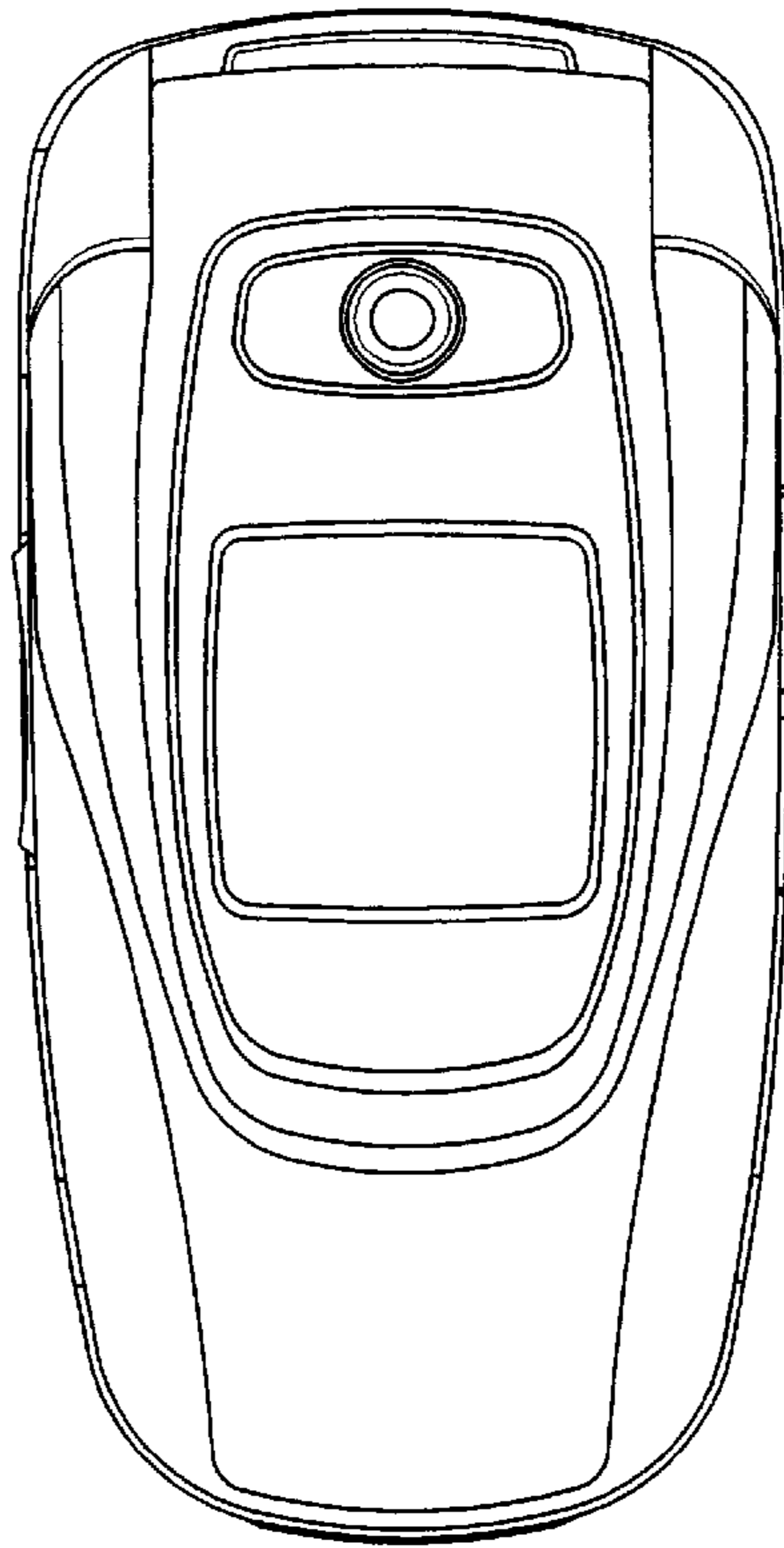

FIG. 3

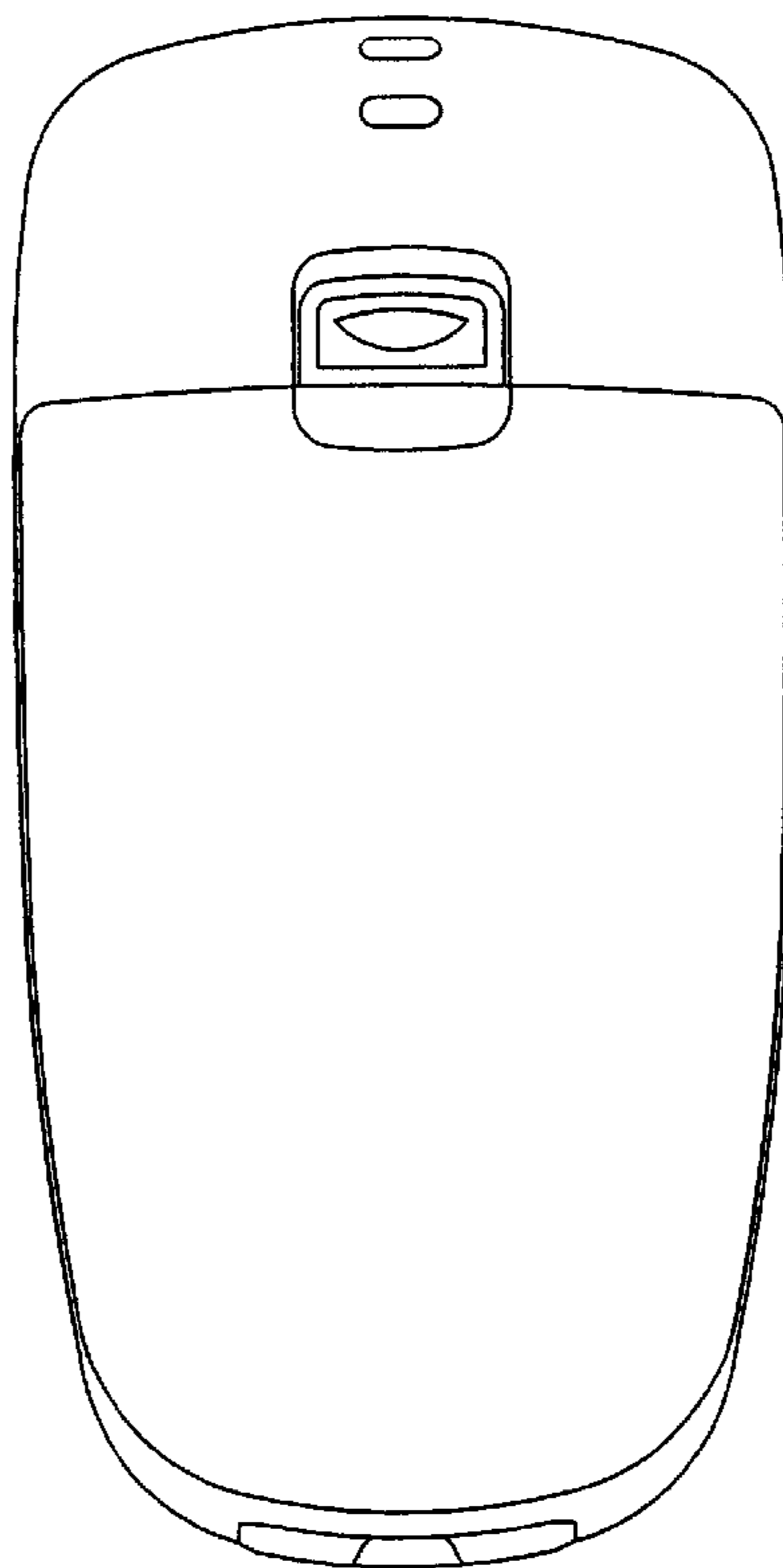

FIG. 4

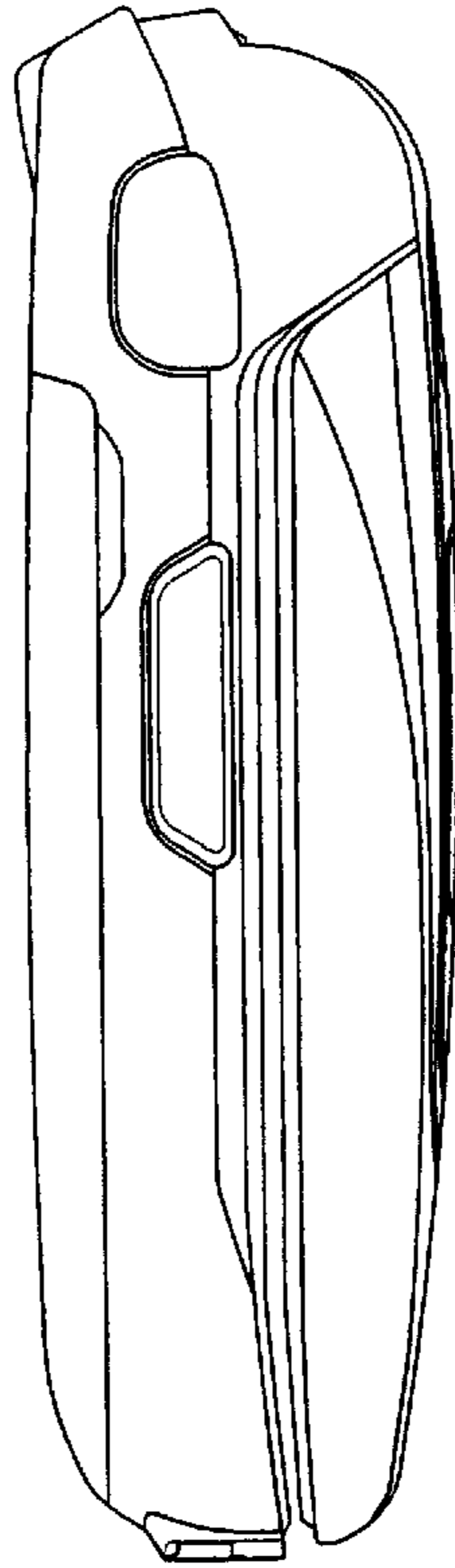
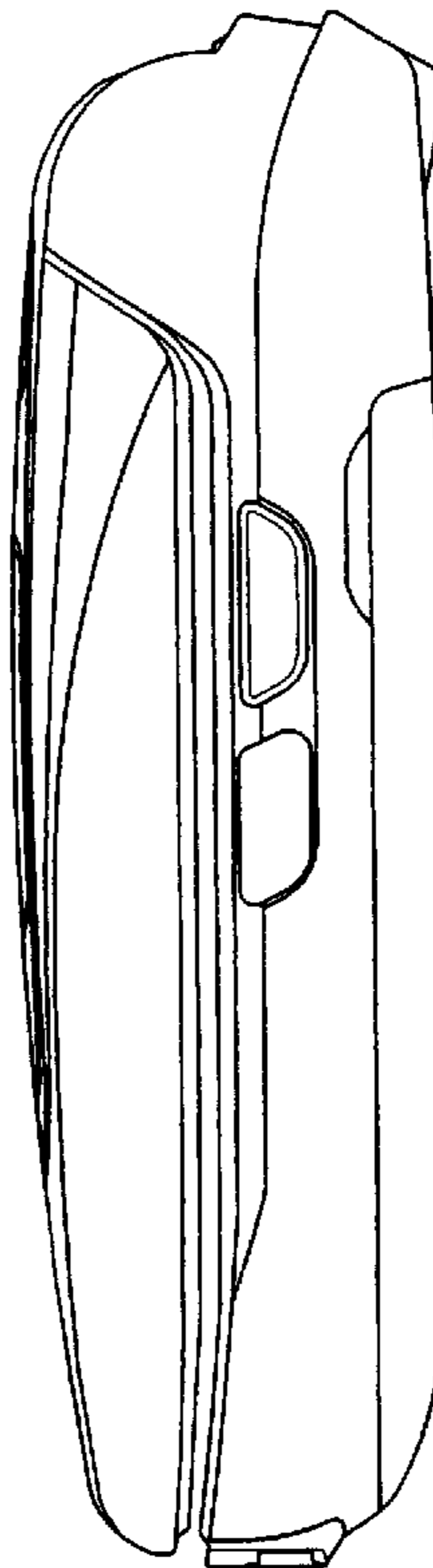

FIG. 5



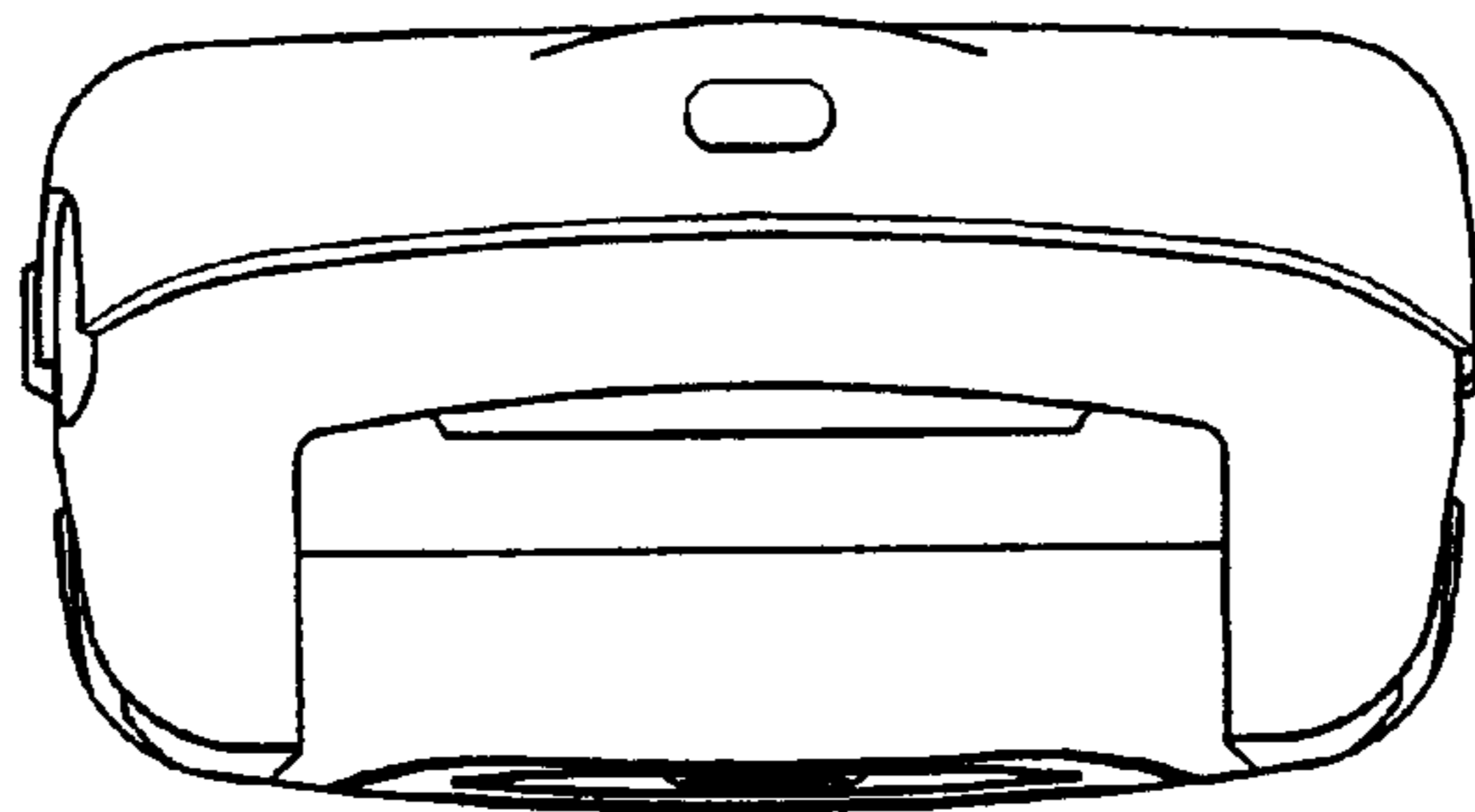

FIG. 6

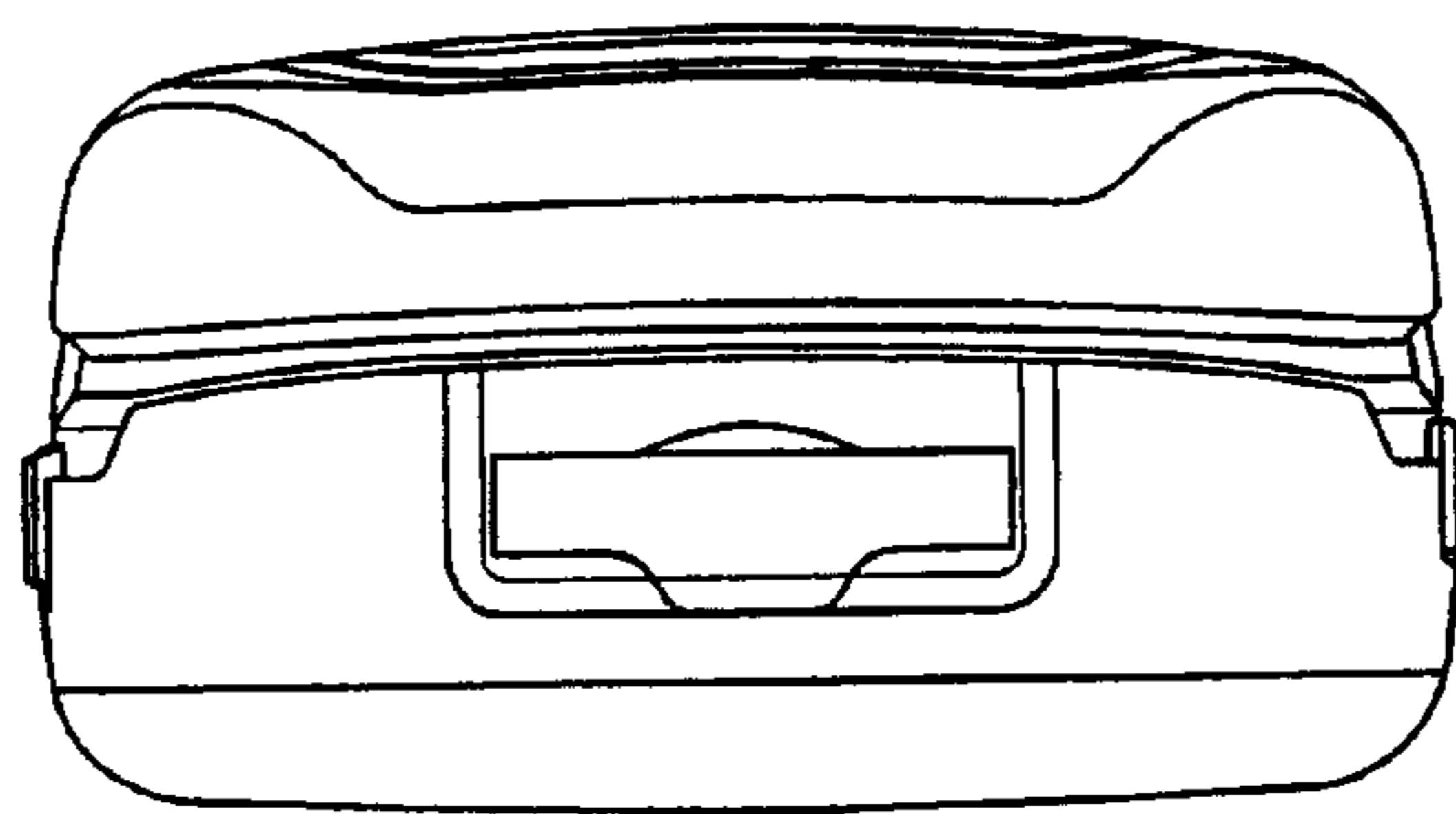

FIG. 7