



US00D535946S

(12) **United States Design Patent**
Hayashi et al.

(10) **Patent No.:** **US D535,946 S**

(45) **Date of Patent:** **** Jan. 30, 2007**

(54) **ELECTRICAL CONNECTOR**

(75) Inventors: **Toshiaki Hayashi**, Aichi (JP); **Atsushi Nishida**, Aichi (JP)

(73) Assignees: **Tyco Electronics AMP K.K.**, Kanagawa-Ken (JP); **Toyota Jidosha Kabushiki Kaisha**, Aichi-Ken (JP)

(**) Term: **14 Years**

(21) Appl. No.: **29/221,301**

(22) Filed: **Jan. 13, 2005**

(30) **Foreign Application Priority Data**

Jul. 16, 2004 (JP) 2004-021597

(51) **LOC (8) Cl.** **13-03**

(52) **U.S. Cl.** **D13/133**

(58) **Field of Classification Search** D13/133-134, D13/146-147, 154, 149, 184, 199; 439/353, 439/488, 586, 620, 682, 685, 752

See application file for complete search history.

(56) **References Cited**

U.S. PATENT DOCUMENTS

- 4,772,229 A * 9/1988 Nix et al. 439/733.1
- D310,994 S * 10/1990 Yagi et al. D13/146
- D311,518 S * 10/1990 Kuzuno et al. D13/146
- D317,751 S * 6/1991 Kozono D13/147
- D324,205 S * 2/1992 Maki et al. D13/133

- D327,249 S * 6/1992 Ohkura et al. D13/133
- 5,127,848 A * 7/1992 Taguchi 439/489
- D402,960 S * 12/1998 Harada D13/134
- D402,961 S * 12/1998 Harada D13/134
- 2002/0086575 A1 * 7/2002 Marpoe et al. 439/352
- 2003/0157825 A1 * 8/2003 Kane 439/352

* cited by examiner

Primary Examiner—Prabhakar Deshmukh

Assistant Examiner—Daniel Bui

(74) *Attorney, Agent, or Firm*—Barley Snyder LLC

(57) **CLAIM**

The ornamental design for an electrical connector, as shown and described.

DESCRIPTION

FIG. 1 is a front elevation view of an electrical connector, showing our new design;

FIG. 2 is a back elevation view thereof;

FIG. 3 is a top plan view thereof;

FIG. 4 is a bottom plan view thereof;

FIG. 5 is a left side elevation view thereof;

FIG. 6 is a right side elevation view thereof;

FIG. 7 is a cross-sectional view thereof, taken along line 7—7 in FIG. 1;

FIG. 8 is a cross-sectional view thereof, taken along line 8—8 in FIG. 1; and,

FIG. 9 is a top, front perspective view thereof.

1 Claim, 5 Drawing Sheets

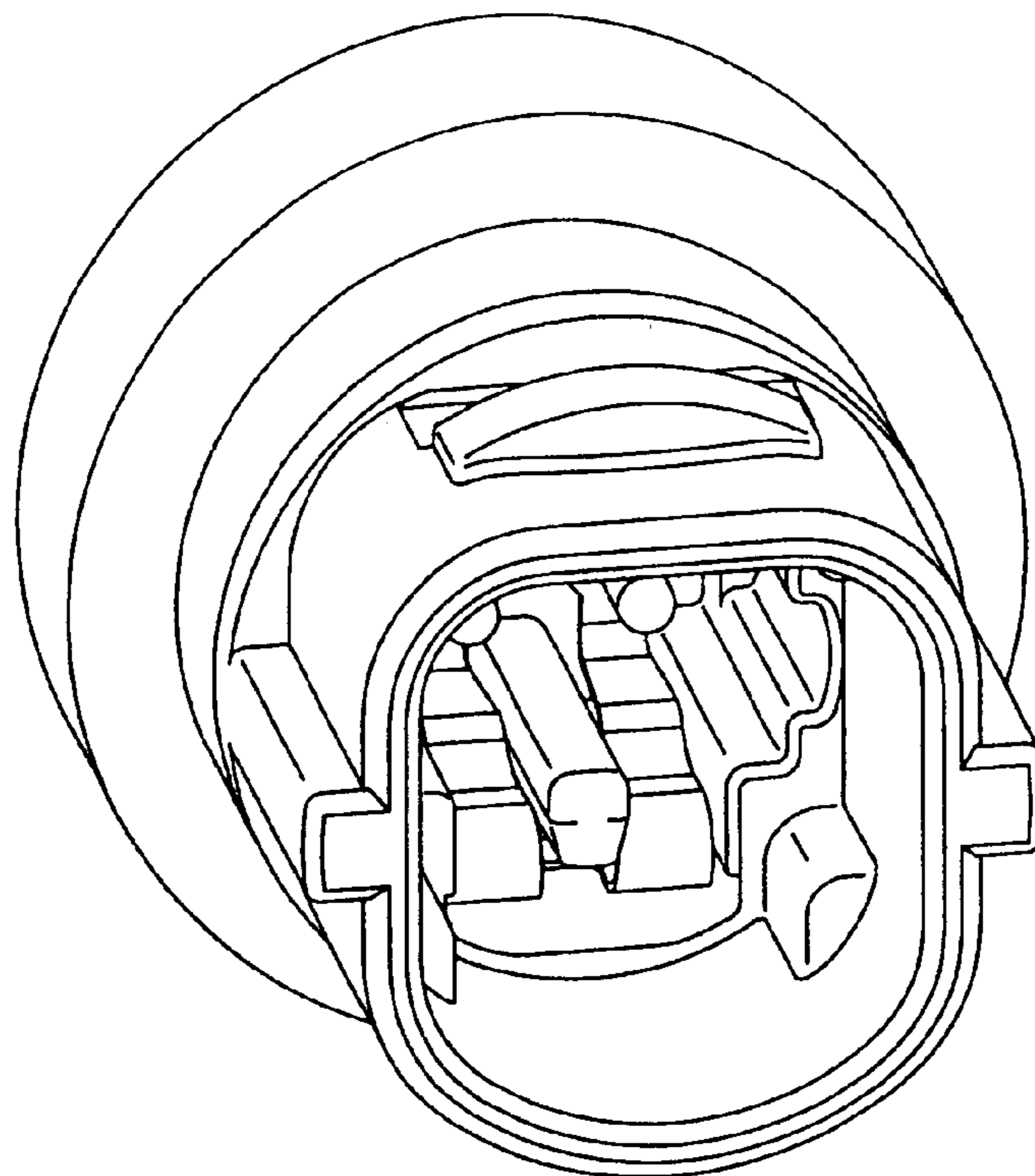

Fig. 1

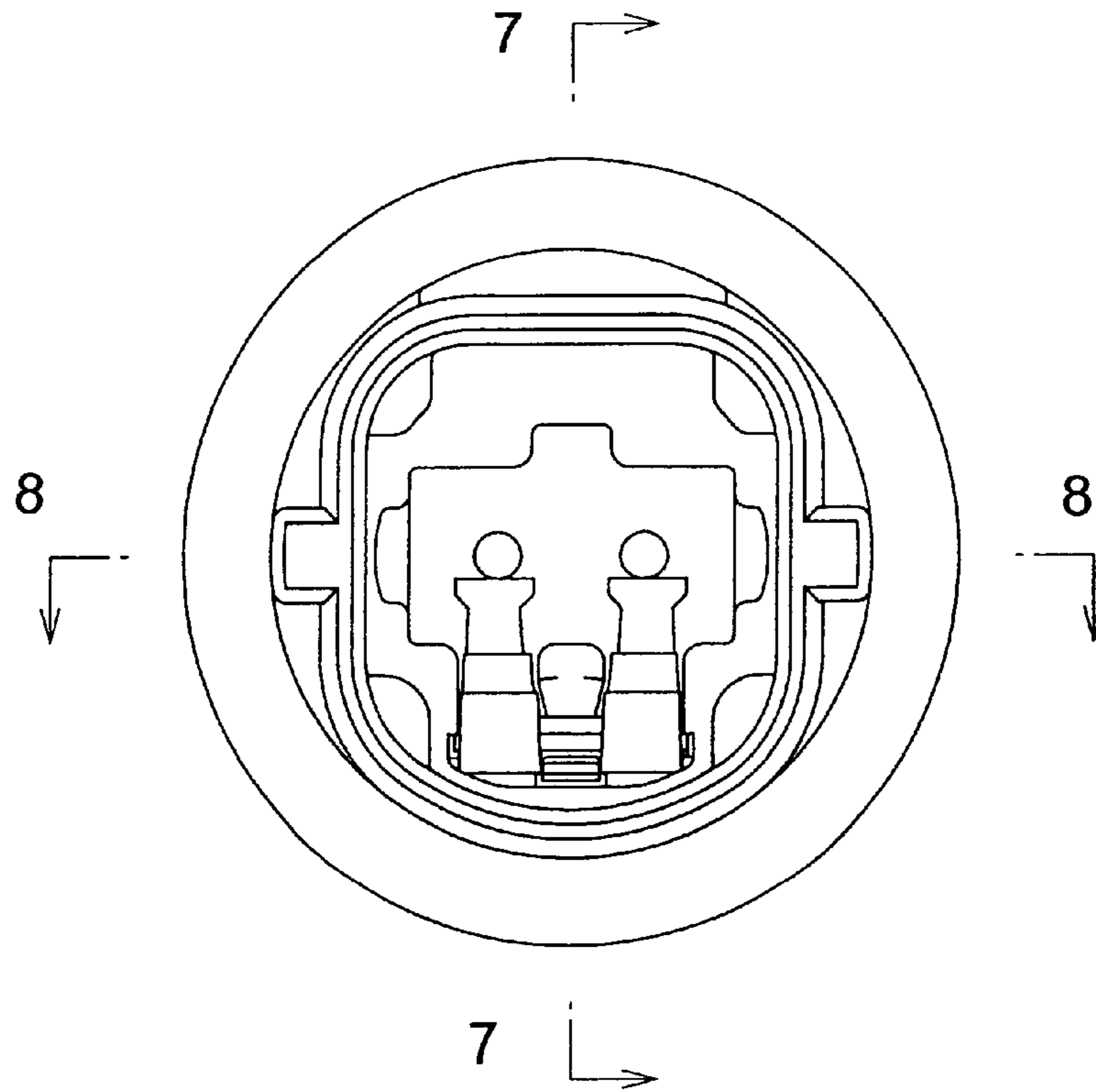

Fig. 2

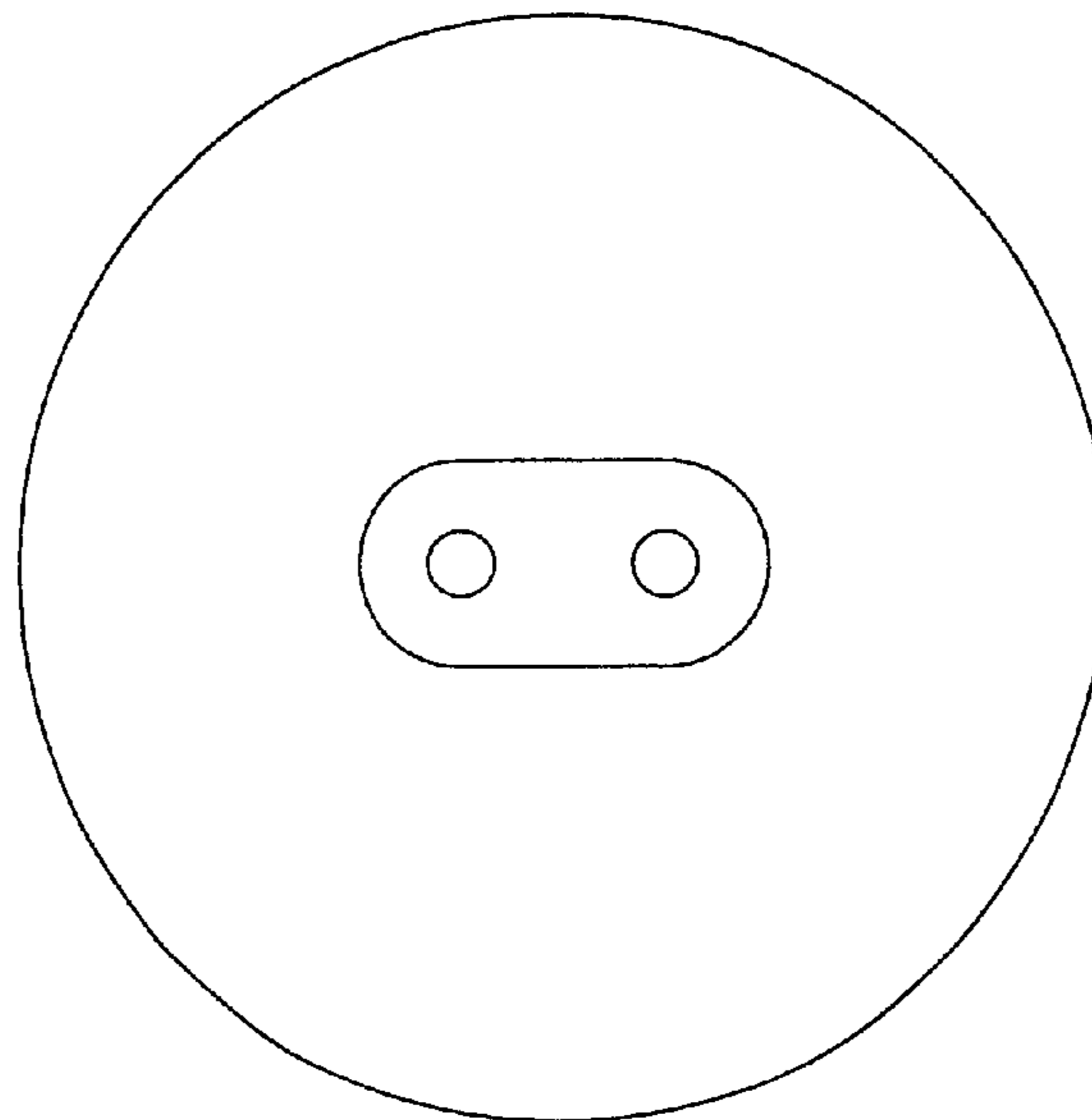

Fig. 3

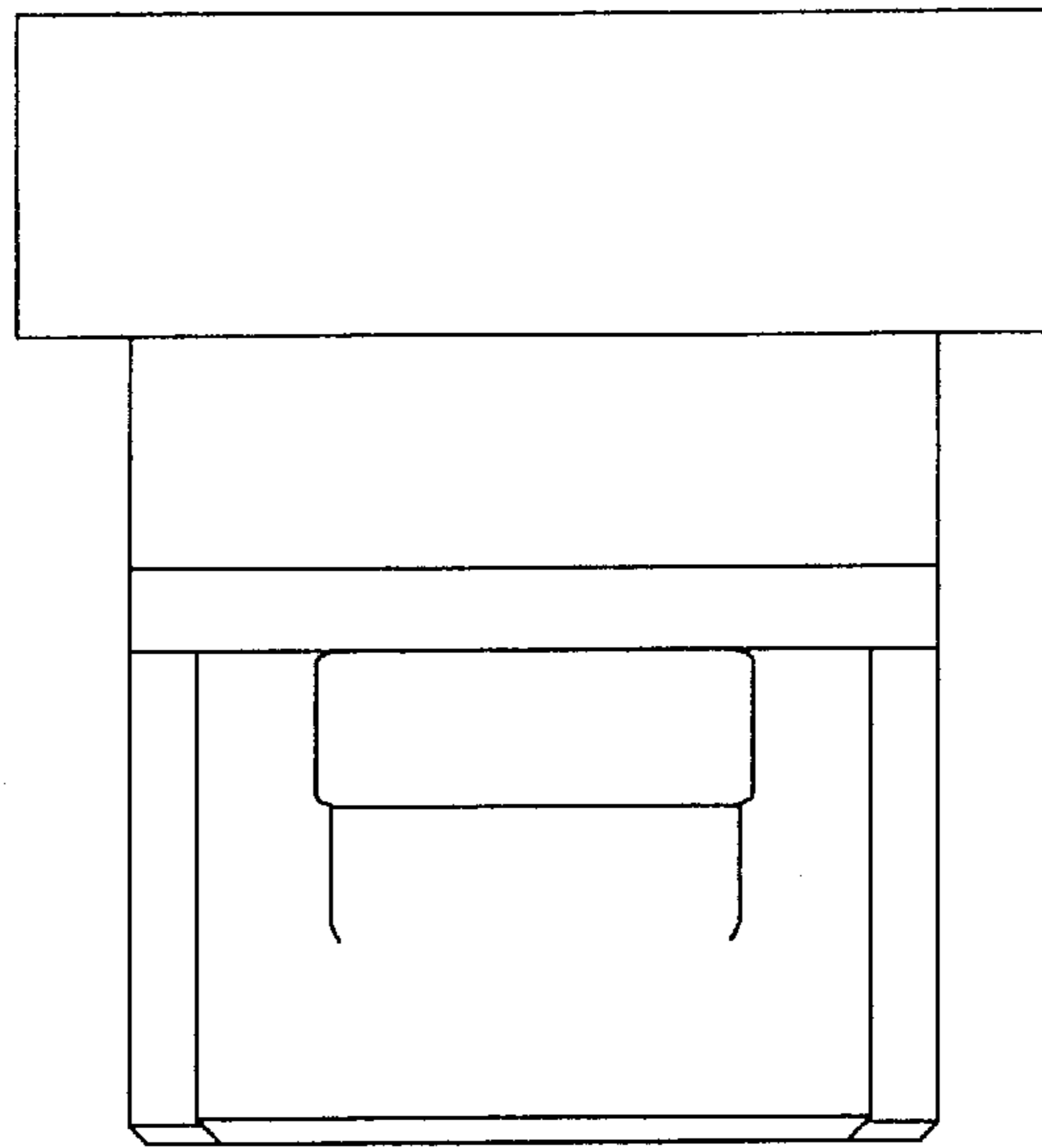

Fig. 4

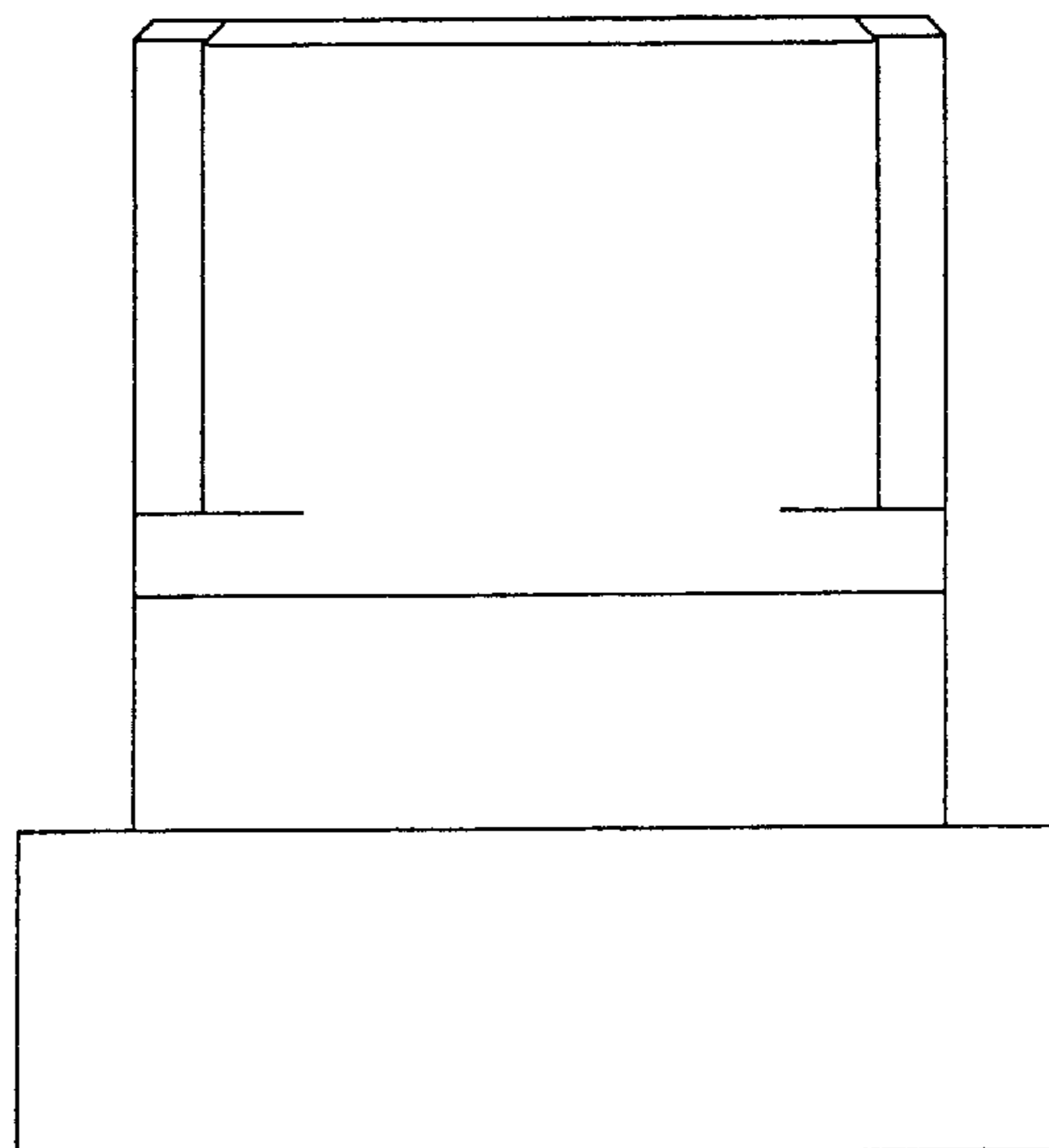

Fig. 5

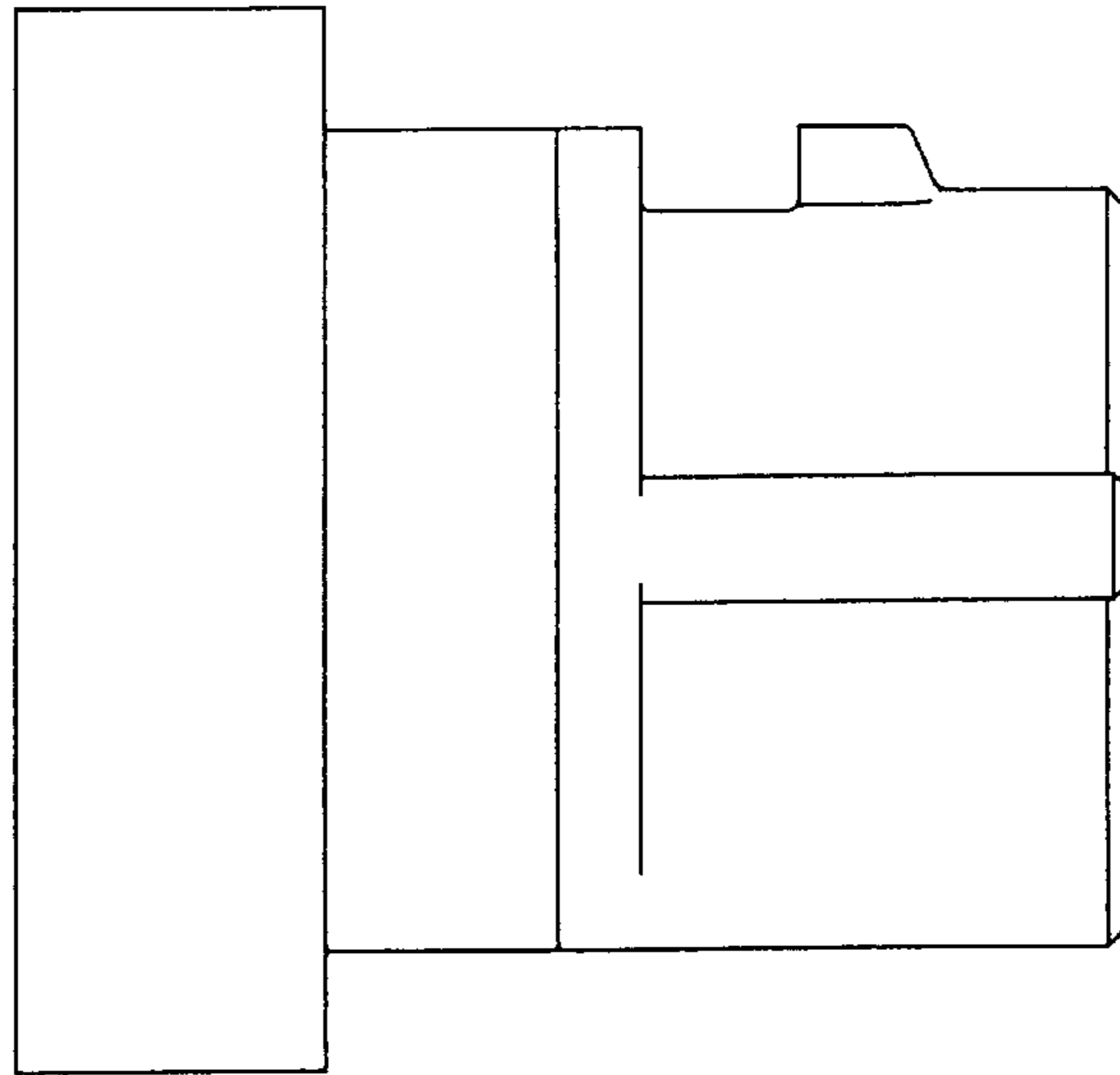

Fig. 6

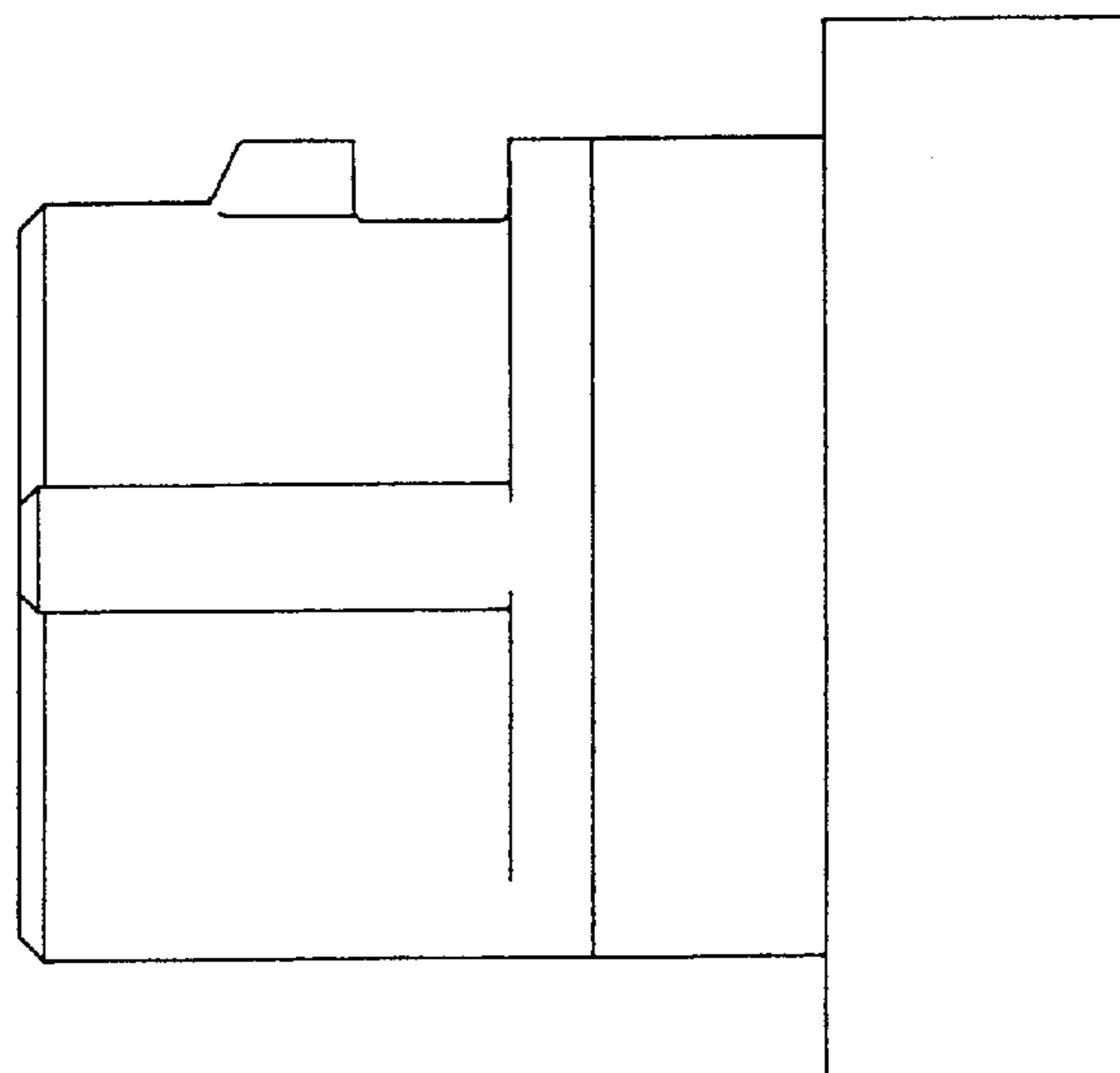

Fig. 7

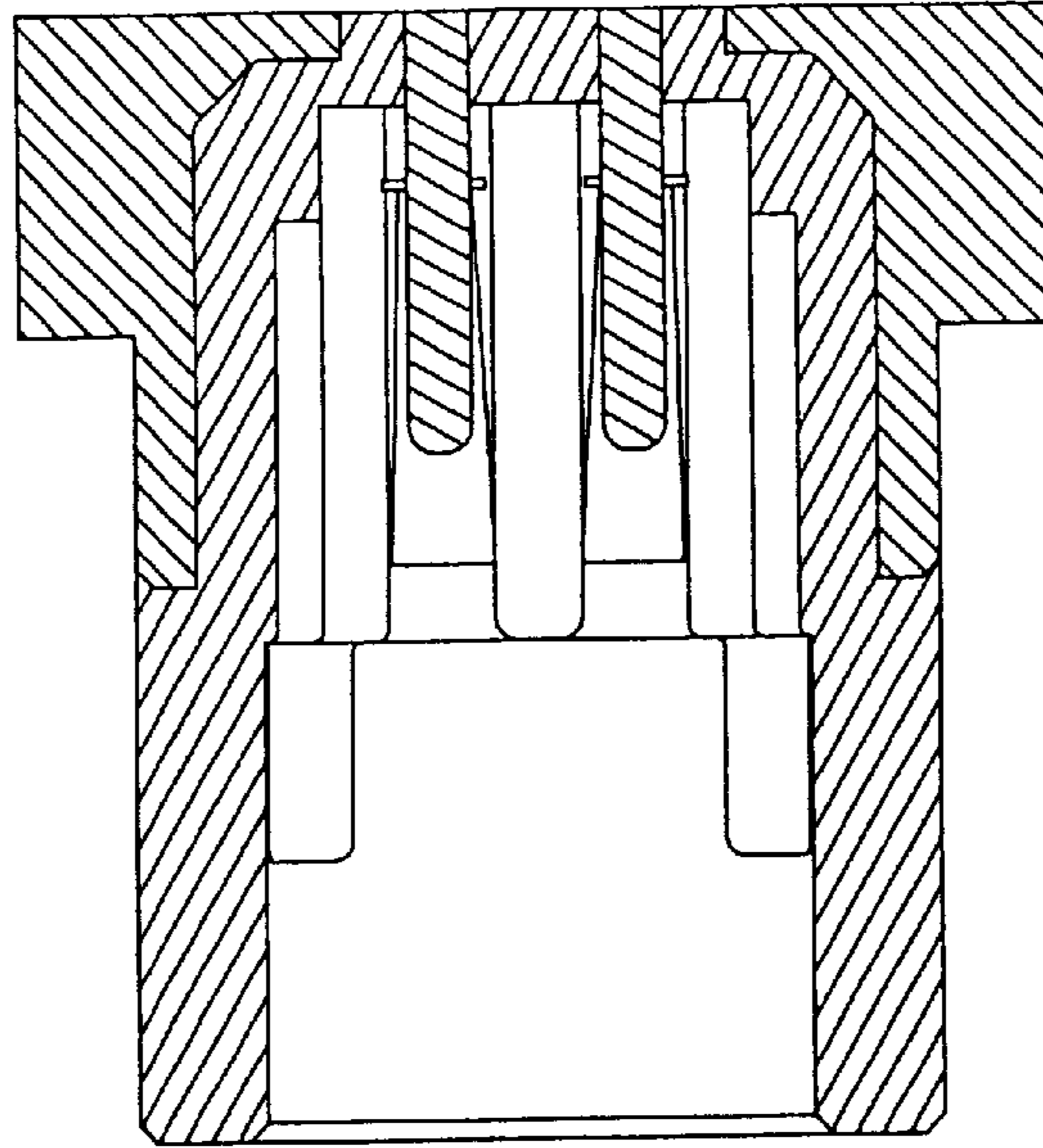

Fig. 8

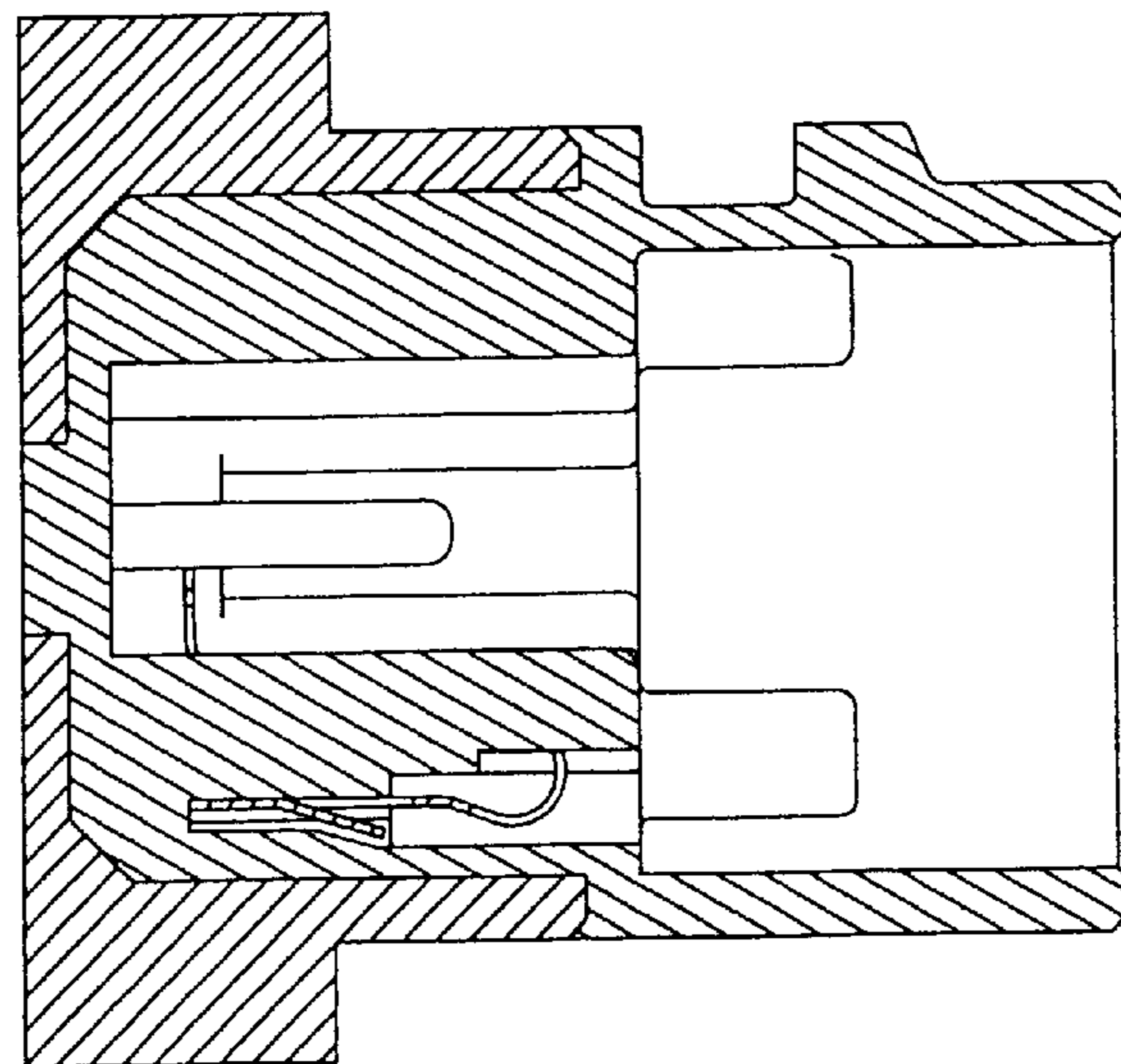

Fig. 9

