



US00D535919S

(12) **United States Design Patent**  
**Hanamura et al.**

(10) **Patent No.:** **US D535,919 S**

(45) **Date of Patent:** **\*\* Jan. 30, 2007**

(54) **OUTER LINK FOR A REAR DERAILLEUR**

(57) **CLAIM**

(75) Inventors: **Junichi Hanamura**, Osaka (JP);  
**Hirohisa Toyoshima**, Osaka (JP)

The ornamental design for an outer link for a rear derailleur,  
as shown and described.

(73) Assignee: **Shimano Inc.**, Osaka (JP)

**DESCRIPTION**

(\*\*) Term: **14 Years**

FIG. 1 is an outside perspective view of an outer link for a rear derailleur in accordance with our new design;  
FIG. 2 is an outside elevational view of the outer link for a rear derailleur in accordance with our new design;  
FIG. 3 is an inside elevational view of the outer link for a rear derailleur in accordance with our new design;  
FIG. 4 is a rear end elevational view of the outer link for a rear derailleur in accordance with our new design;  
FIG. 5 is a front end elevational view of the outer link for a rear derailleur in accordance with our new design;  
FIG. 6 is a top plan view of the outer link for a rear derailleur in accordance with our new design; and,  
FIG. 7 is a bottom plan view of the outer link for a rear derailleur in accordance with our new design.  
The broken line showing of environment (the remaining structure of the rear derailleur) in the Figures is for illustrative purposes only and forms no part of the claimed design.

(21) Appl. No.: **29/244,939**

(22) Filed: **Dec. 16, 2005**

(51) **LOC (8) Cl.** ..... **12-11**

(52) **U.S. Cl.** ..... **D12/124**

(58) **Field of Classification Search** ..... D12/111,  
D12/124; 474/80-82, 78

See application file for complete search history.

(56) **References Cited**

**U.S. PATENT DOCUMENTS**

6,315,688 B1 11/2001 McLaughlin et al.

*Primary Examiner*—Freda Nunn

*Assistant Examiner*—Linda Brooks

(74) *Attorney, Agent, or Firm*—Global IP Counselors, LLP

**1 Claim, 7 Drawing Sheets**

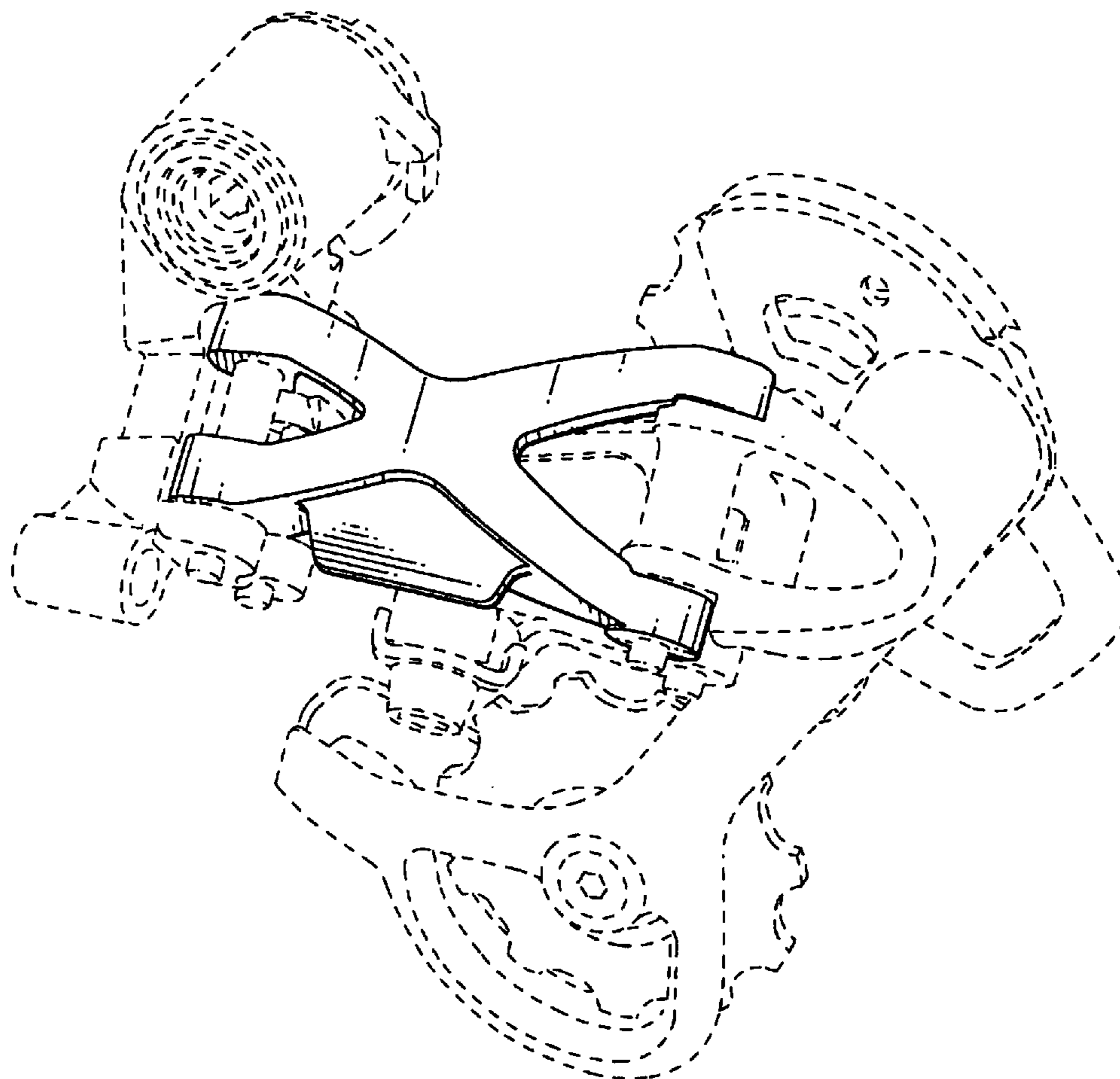

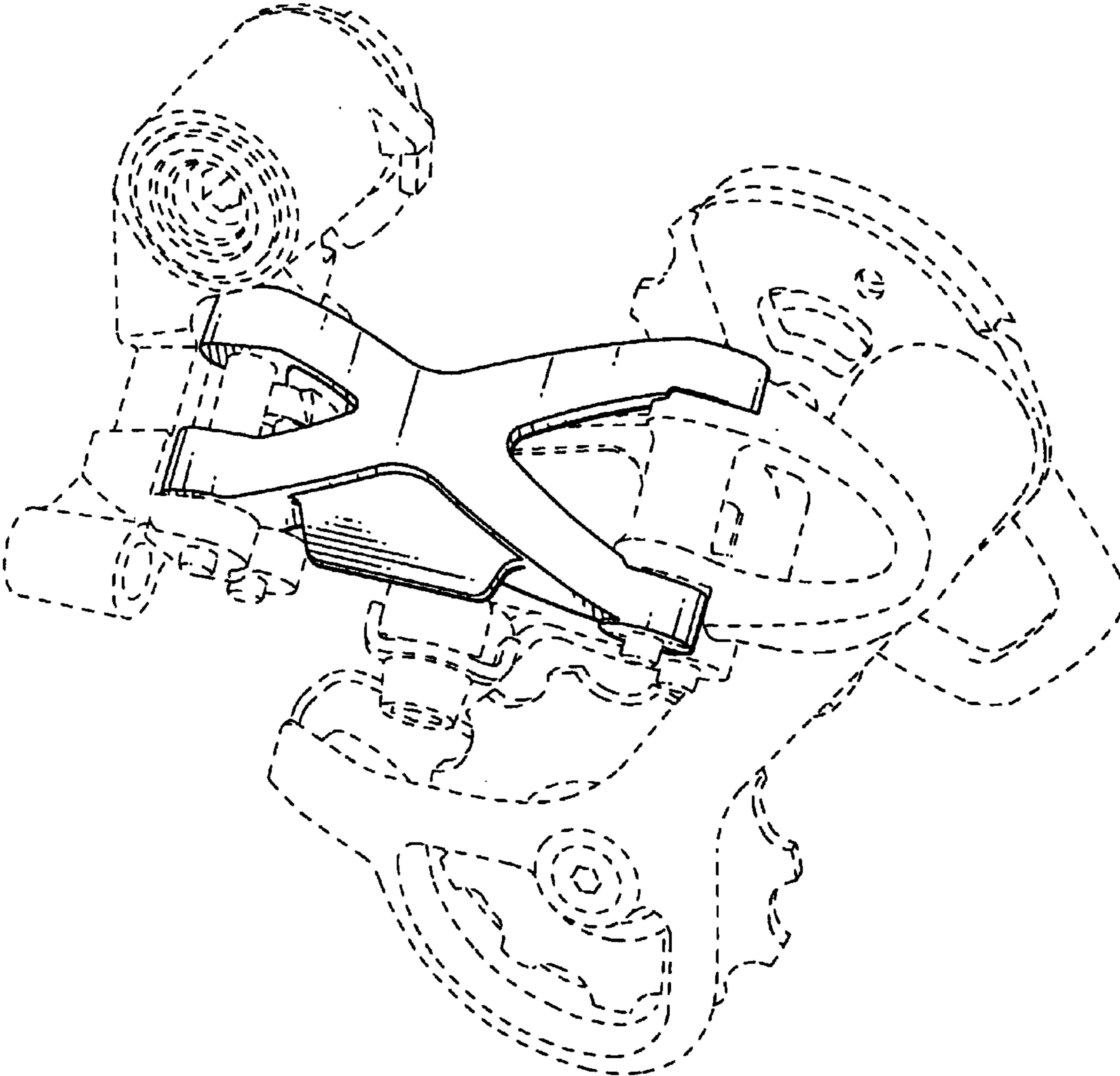

FIG. 1

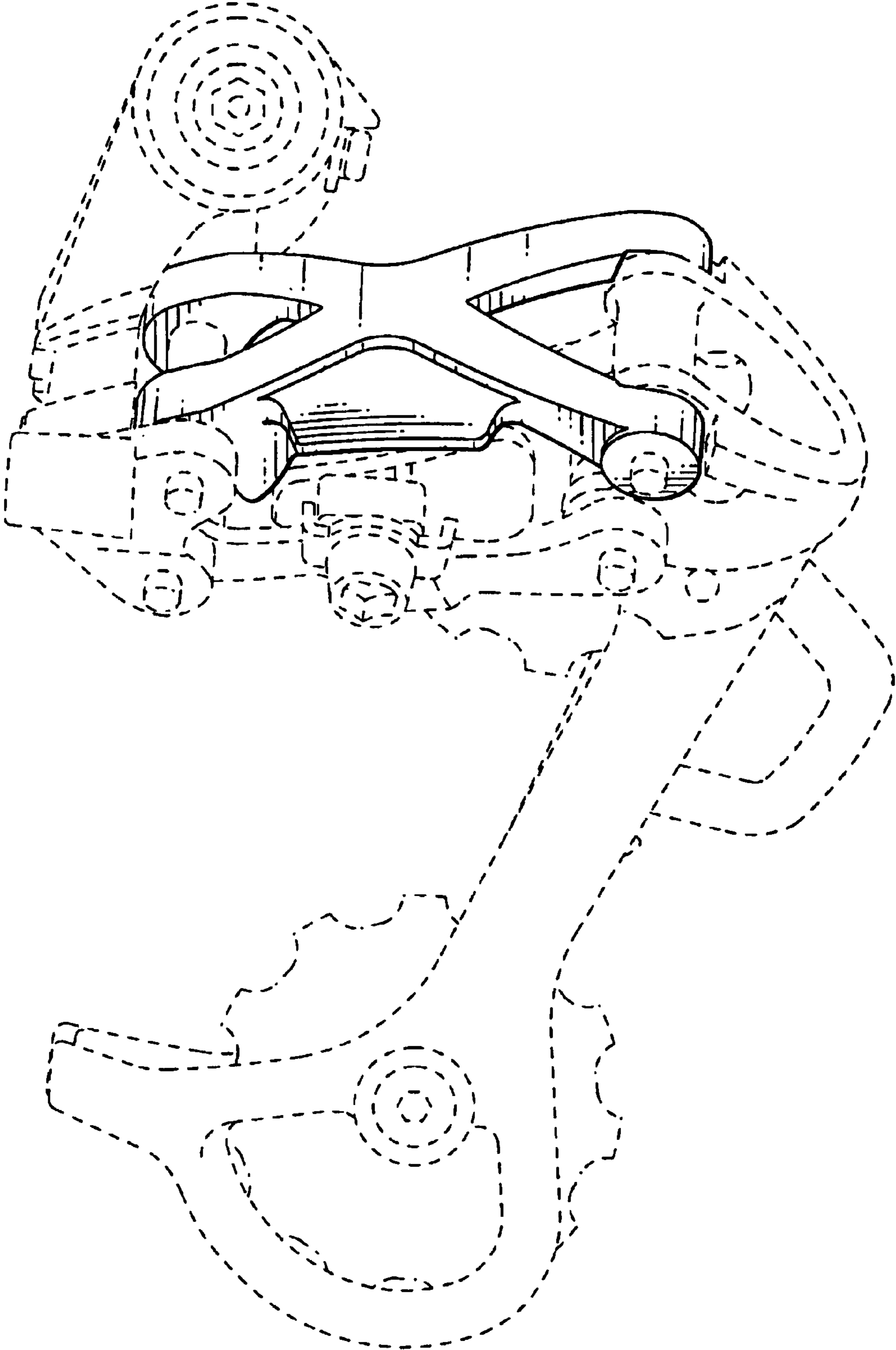

FIG. 2

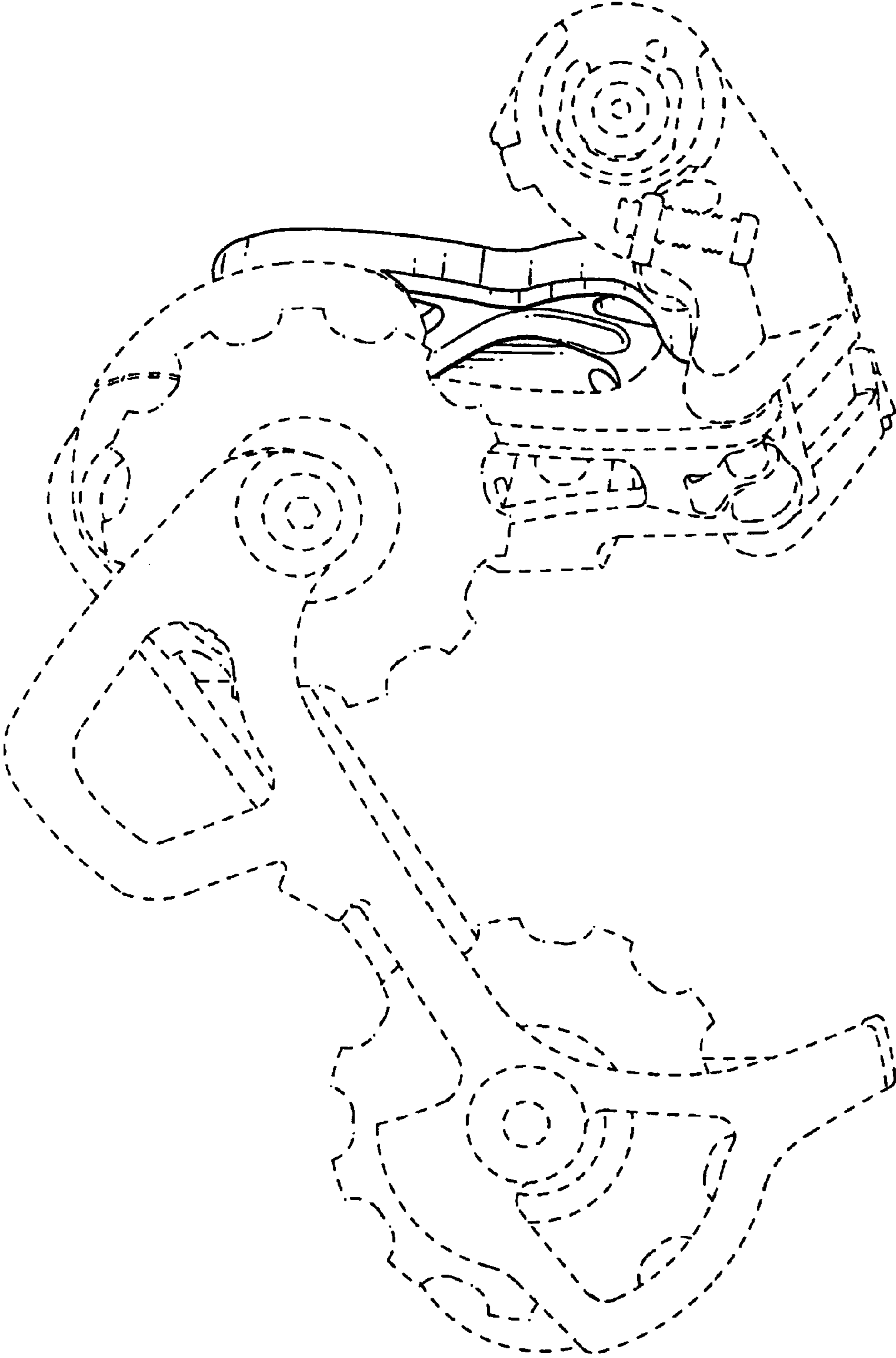

FIG. 3

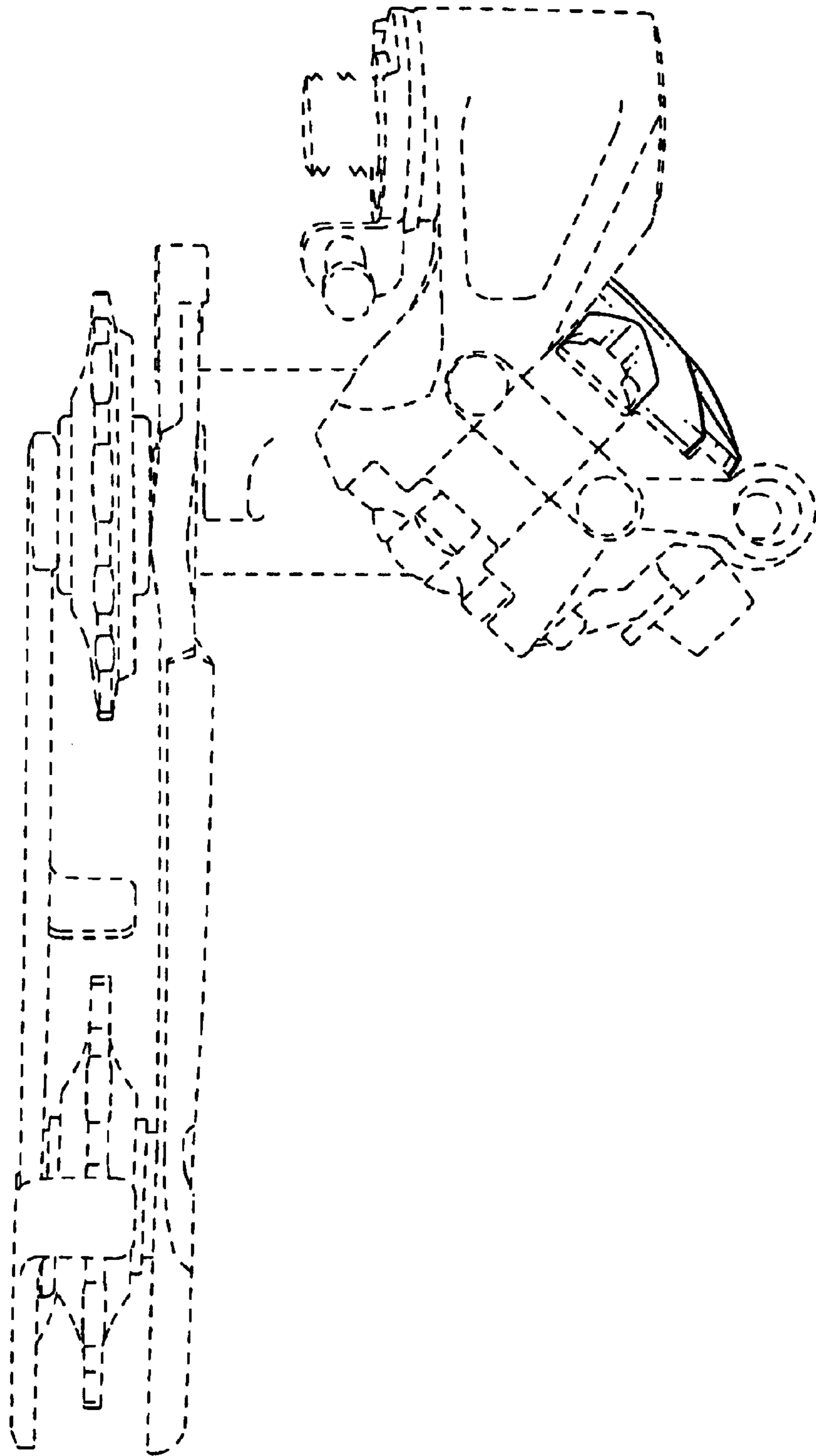

FIG. 4



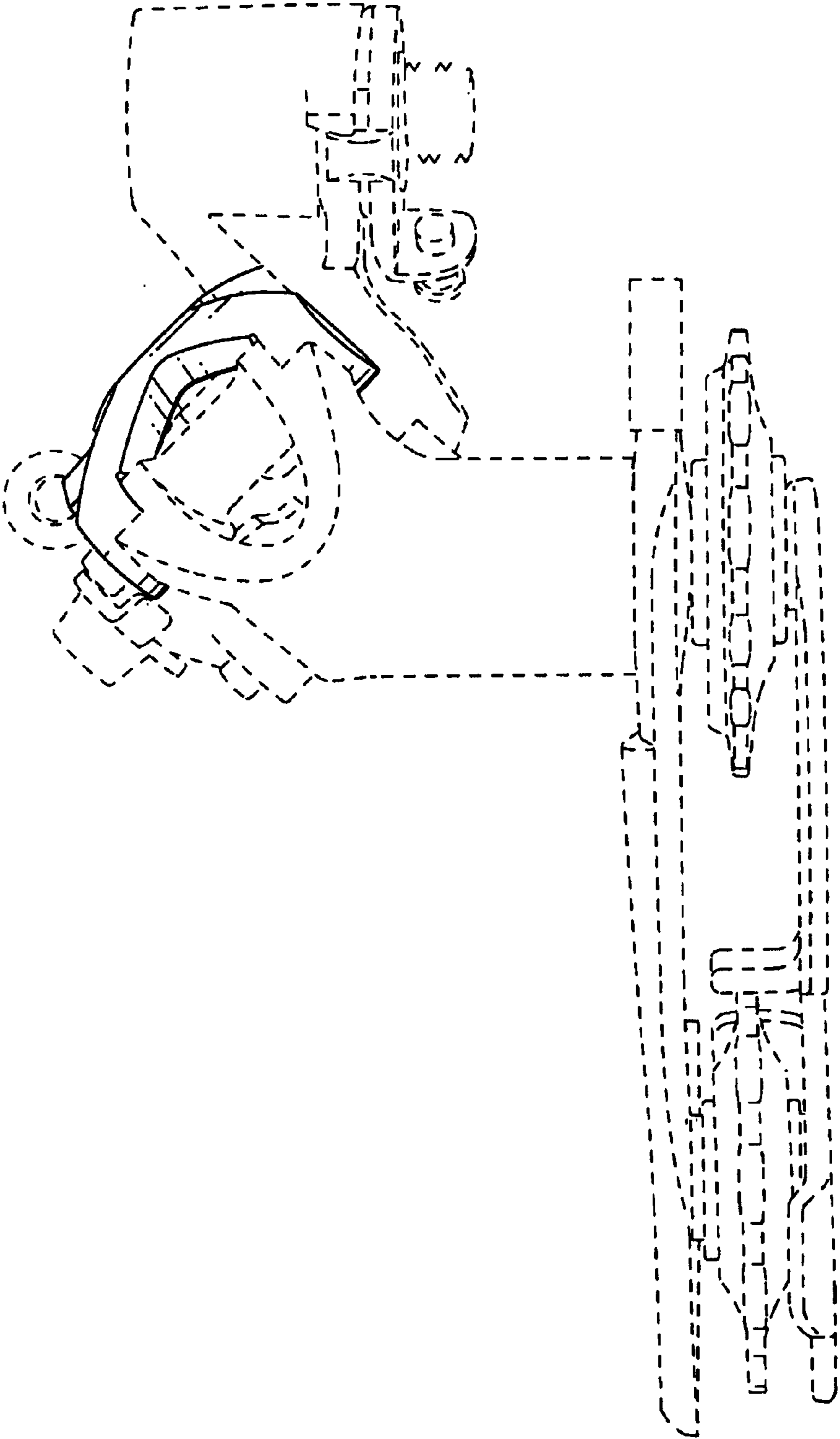

FIG. 5

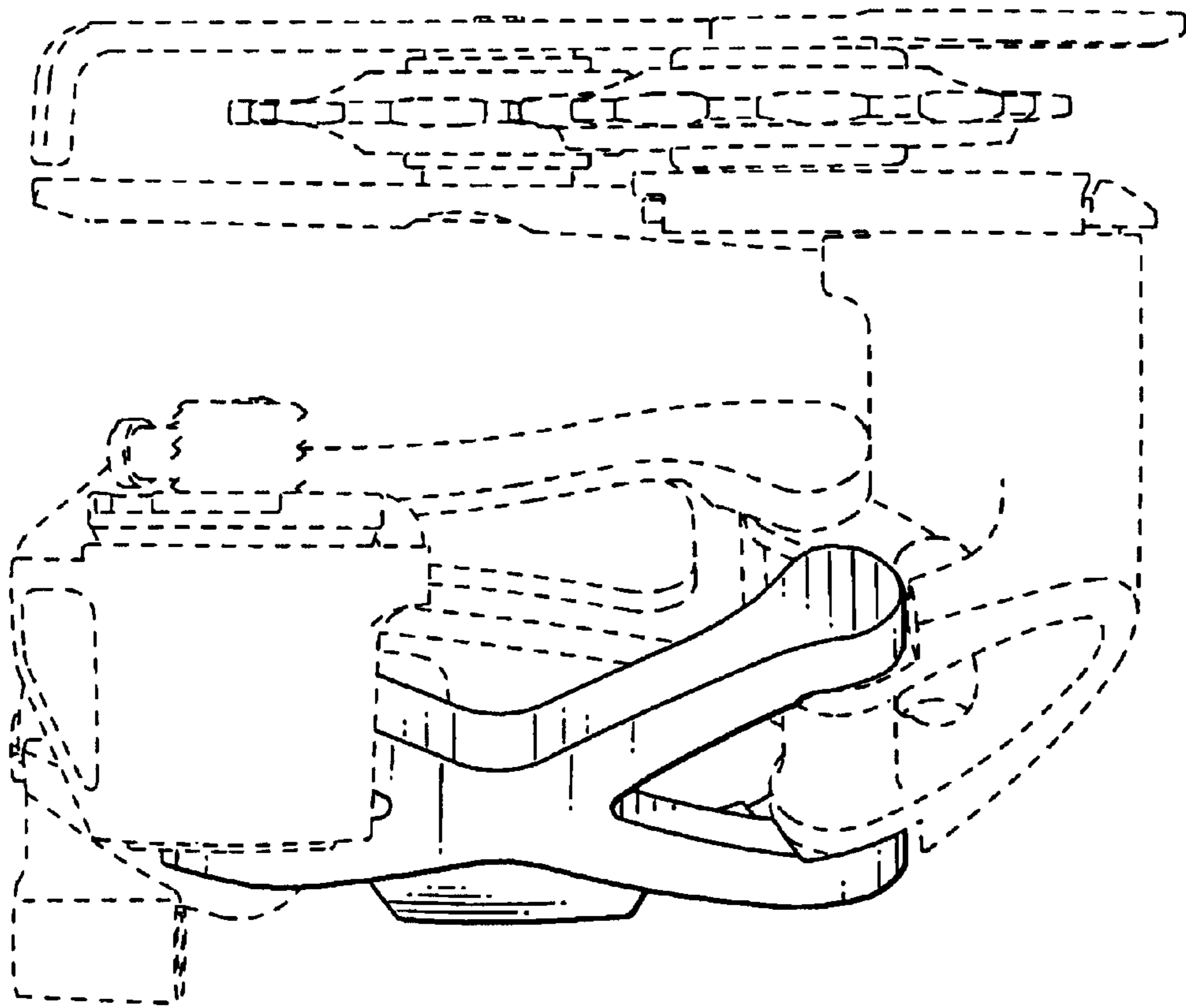

FIG. 6

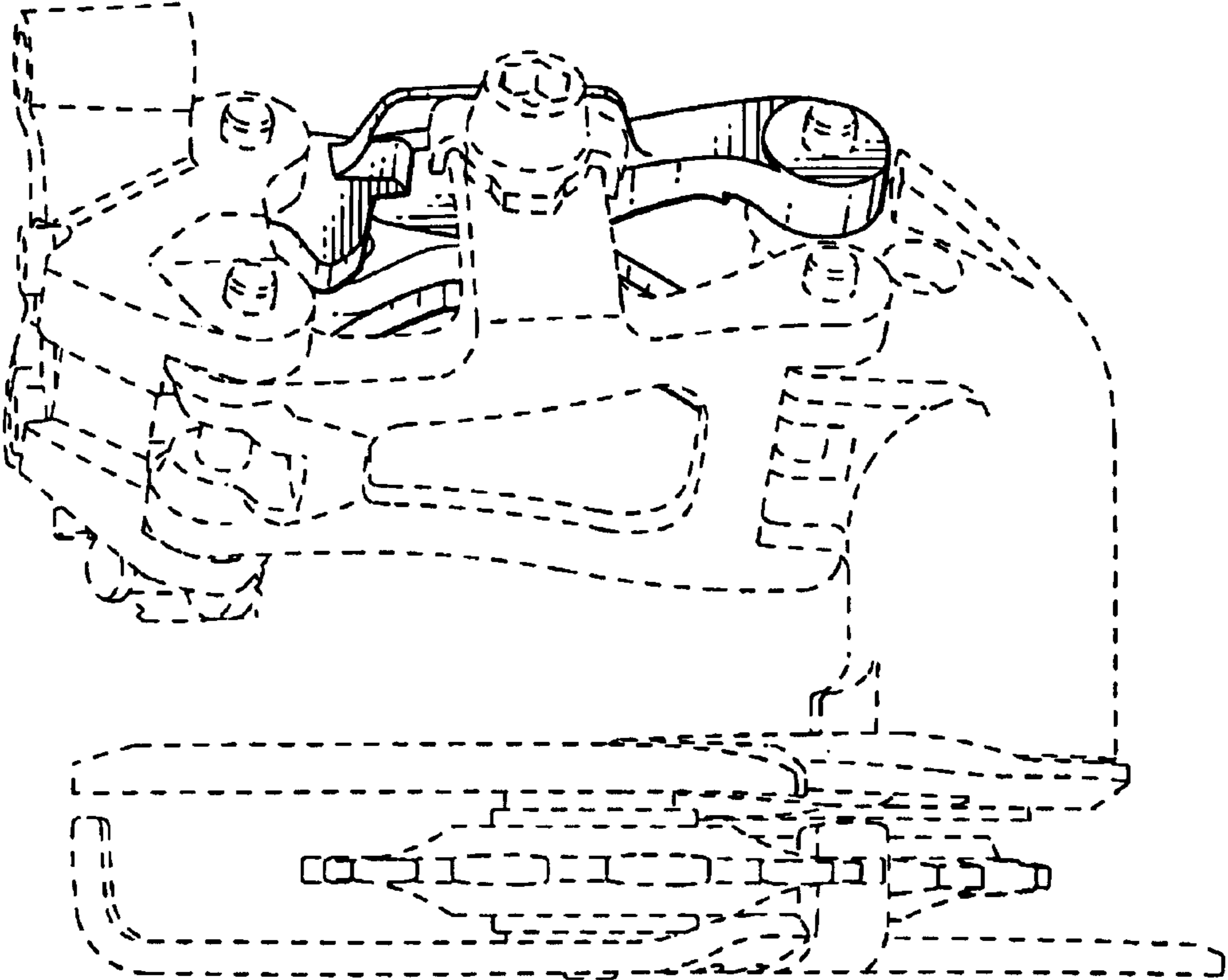

FIG. 7