



US00D535788S

(12) **United States Design Patent**  
**Ng**

(10) **Patent No.:** **US D535,788 S**  
(45) **Date of Patent:** **\*\* Jan. 23, 2007**

(54) **ELECTRIC HAIR CLIPPER**

(75) Inventor: **Zachary Ng**, Tokyo (JP)

(73) Assignee: **Matsushita Electric Works, Ltd.**,  
Osaka (JP)

(\*\*) Term: **14 Years**

(21) Appl. No.: **29/255,061**

(22) Filed: **Mar. 3, 2006**

(30) **Foreign Application Priority Data**

Sep. 5, 2005 (JP) ..... 2005-025577

(51) **LOC (8) Cl.** ..... **28-03**

(52) **U.S. Cl.** ..... **D28/53**

(58) **Field of Classification Search** ..... 30/201,  
30/32, 34.05, 34.1, 34.2, 41-41.6, 43-43.92,  
30/44-45, 47-50, 526-533; D28/44-46,  
D28/49-53

See application file for complete search history.

(56) **References Cited**

**U.S. PATENT DOCUMENTS**

D499,844 S \* 12/2004 Muramatsu ..... D28/53  
D512,184 S \* 11/2005 Akahori ..... D28/53  
D512,532 S \* 12/2005 Akahori ..... D28/53  
D521,684 S \* 5/2006 Izumi et al. .... D28/53

**FOREIGN PATENT DOCUMENTS**

EP 000192430-0001 8/2004

JP 1221495 11/2004

\* cited by examiner

*Primary Examiner*—Jennifer Rivard

(74) *Attorney, Agent, or Firm*—Osha Liang LLP

(57) **CLAIM**

The ornamental design for an electric hair clipper, as shown and described.

**DESCRIPTION**

FIG. 1 shows a front perspective view of the design according to the invention.

FIG. 2 shows a rear perspective view of the design according to the invention.

FIG. 3 shows a front view of the design according to the invention.

FIG. 4 shows a rear view of the design according to the invention.

FIG. 5 shows a top view of the design according to the invention.

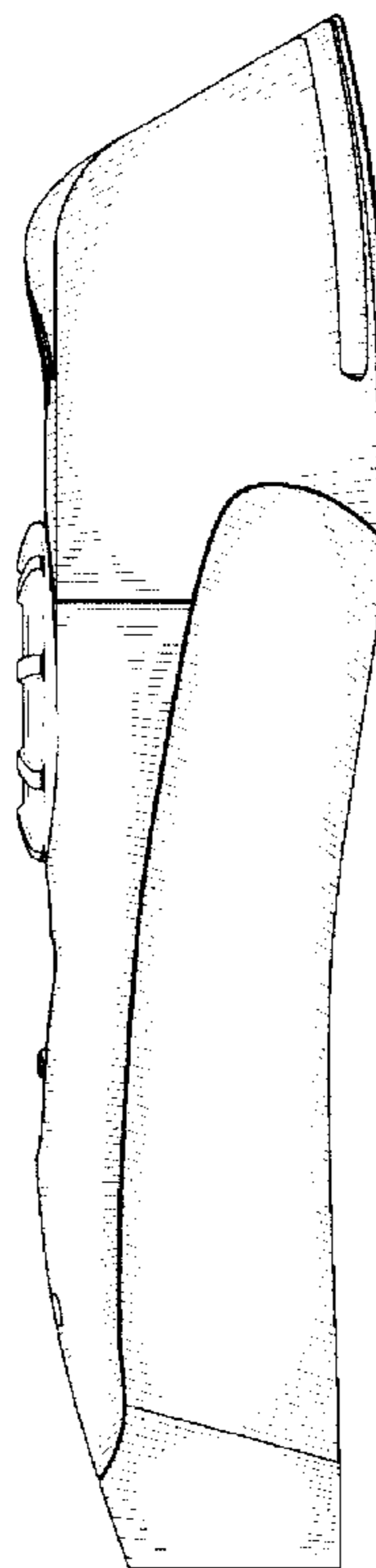
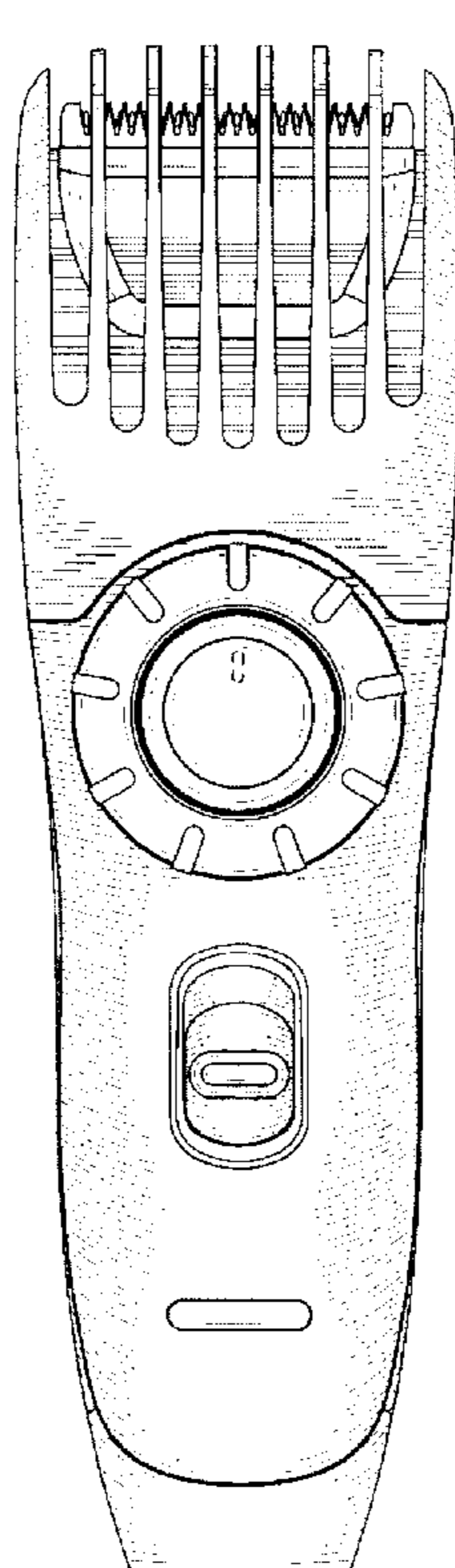
FIG. 6 shows a bottom view of the design according to the invention.

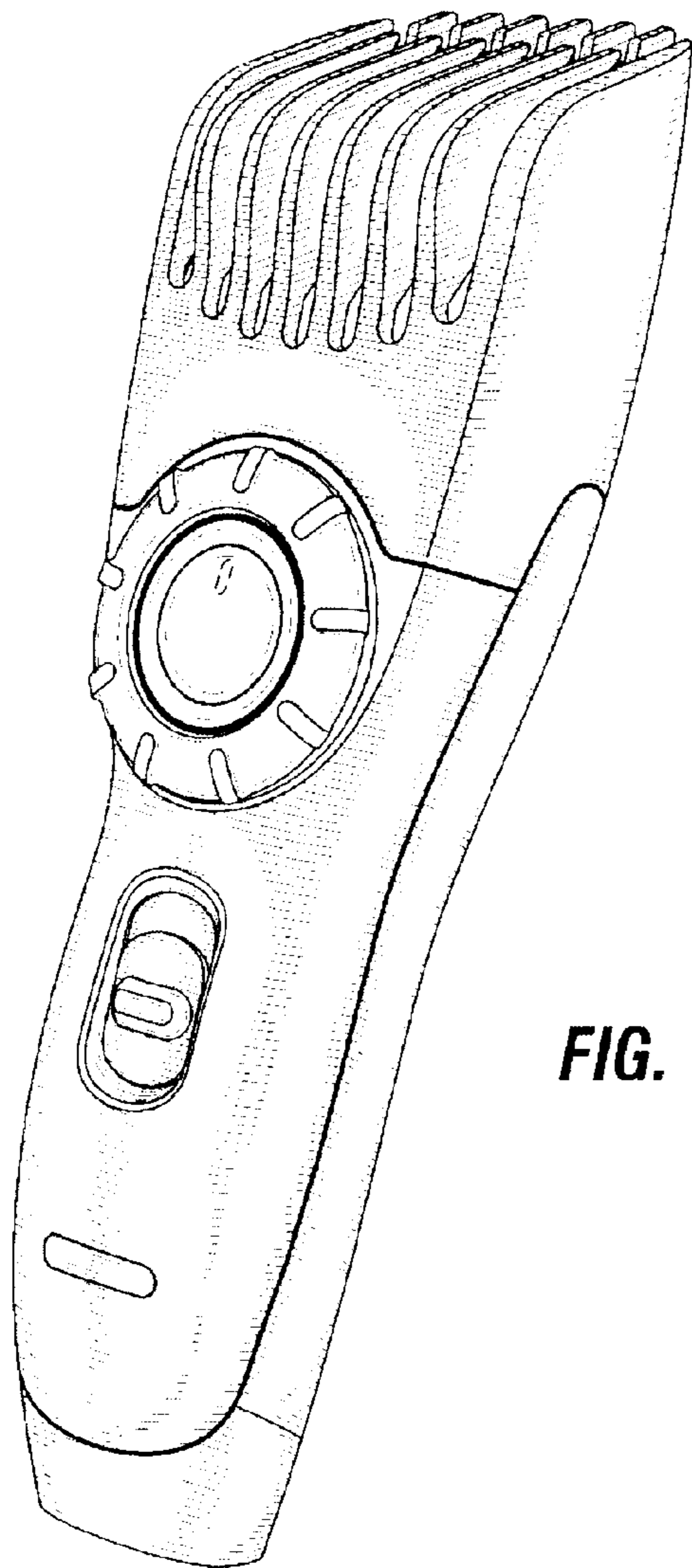
FIG. 7 shows a left side view of the design according to the invention; and,

FIG. 8 shows a right side view of the design according to the invention.

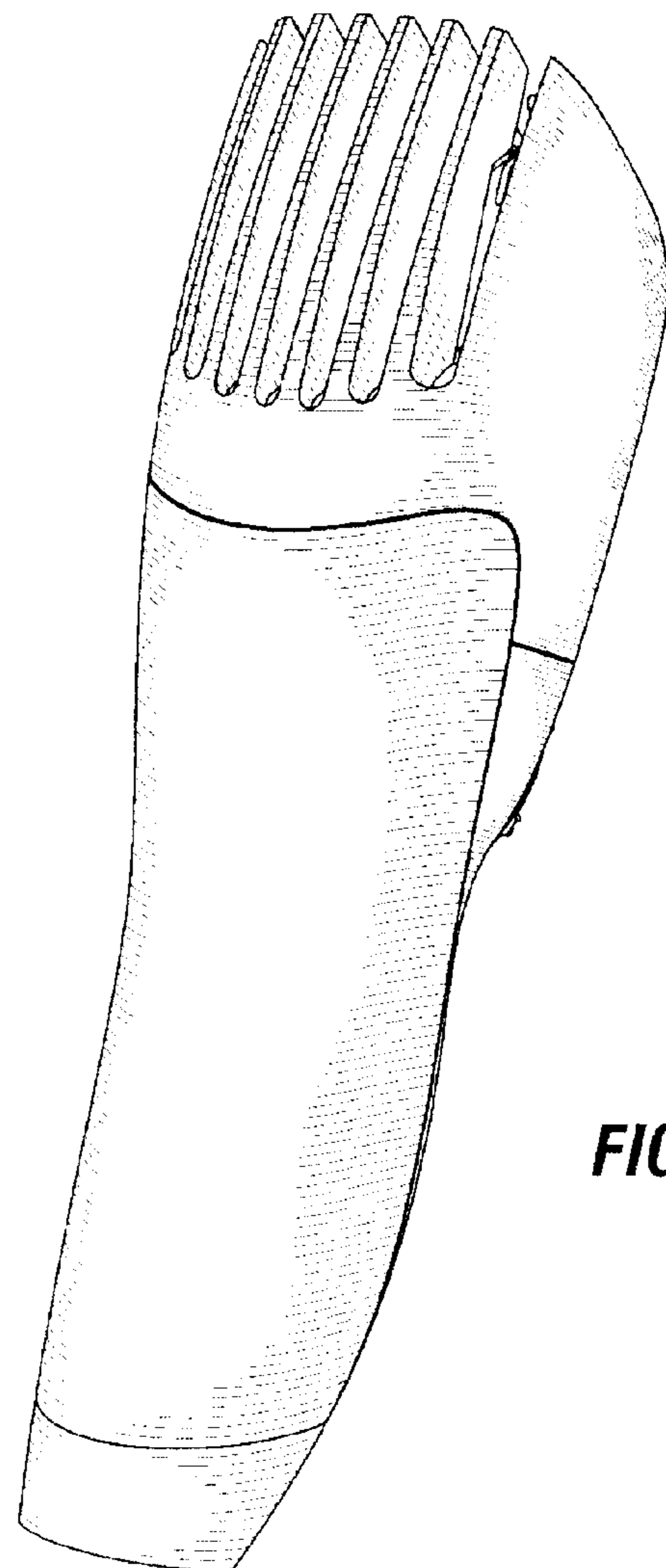
The portions in even broken lines are for illustrative purposes only and form no part of the claimed design.

**1 Claim, 3 Drawing Sheets**

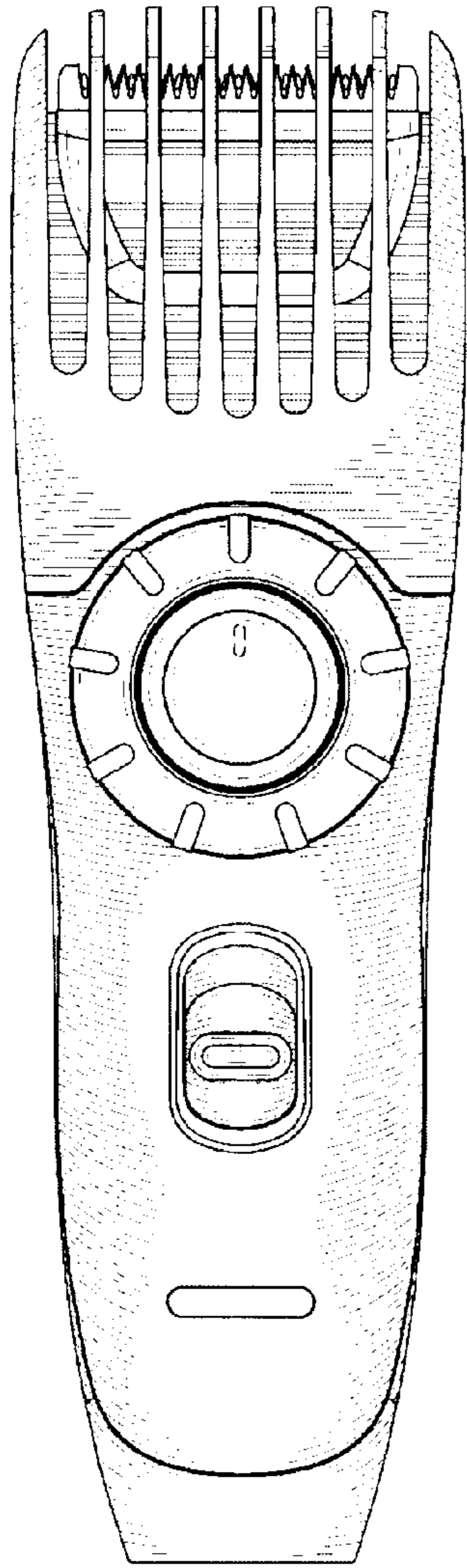




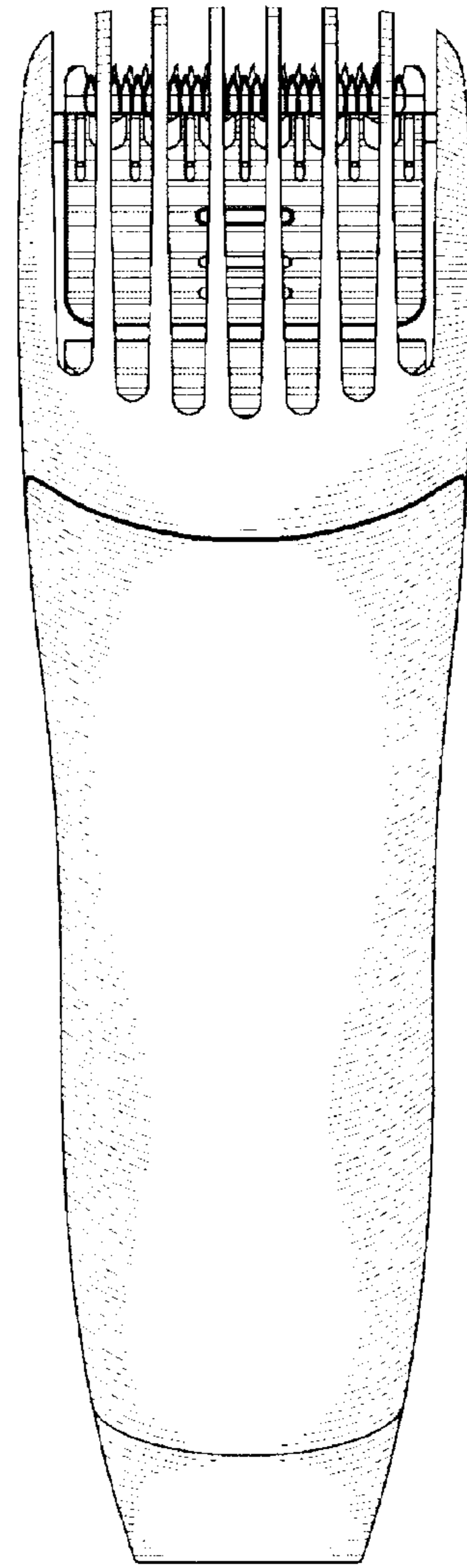
**FIG. 1**



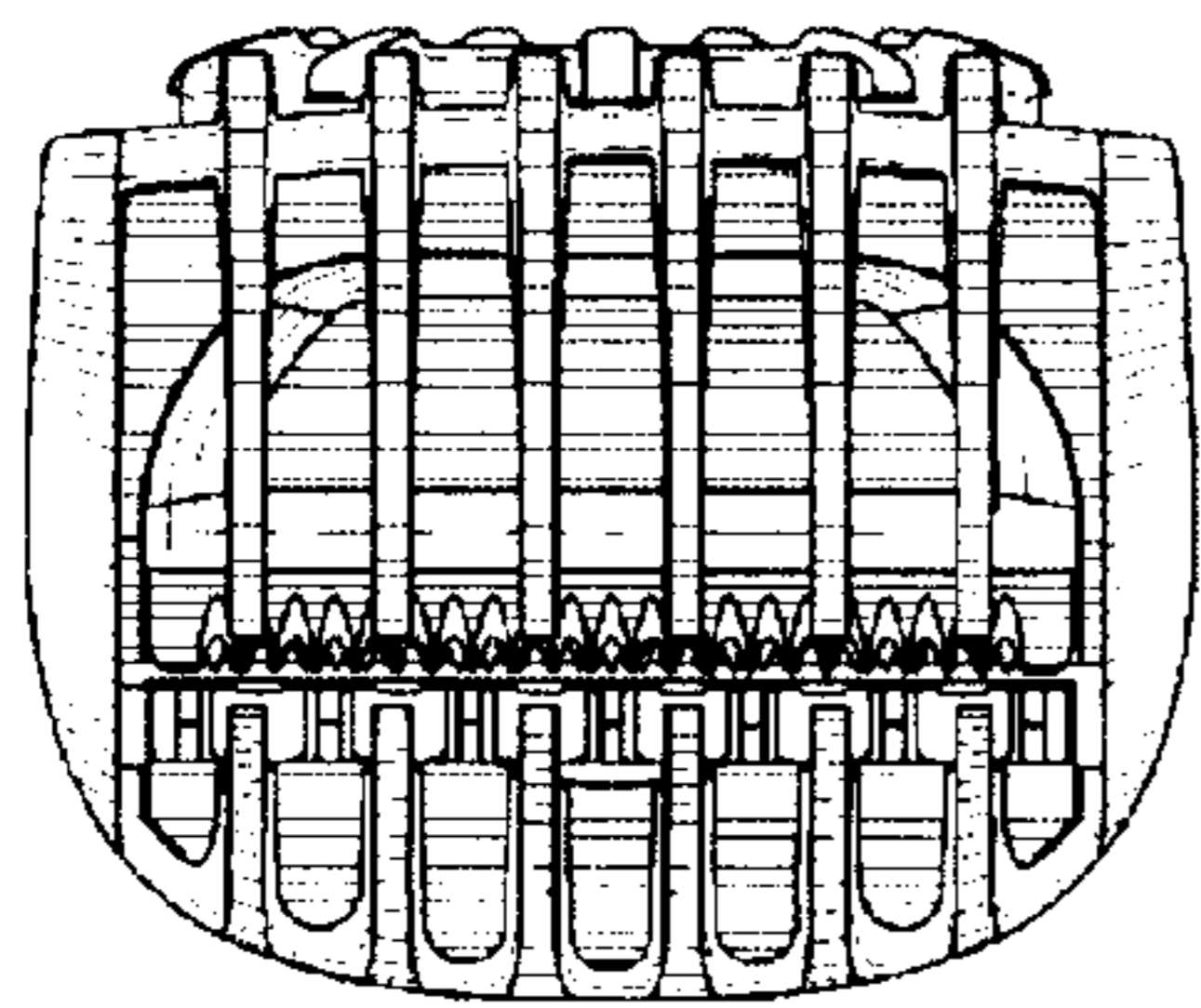
**FIG. 2**



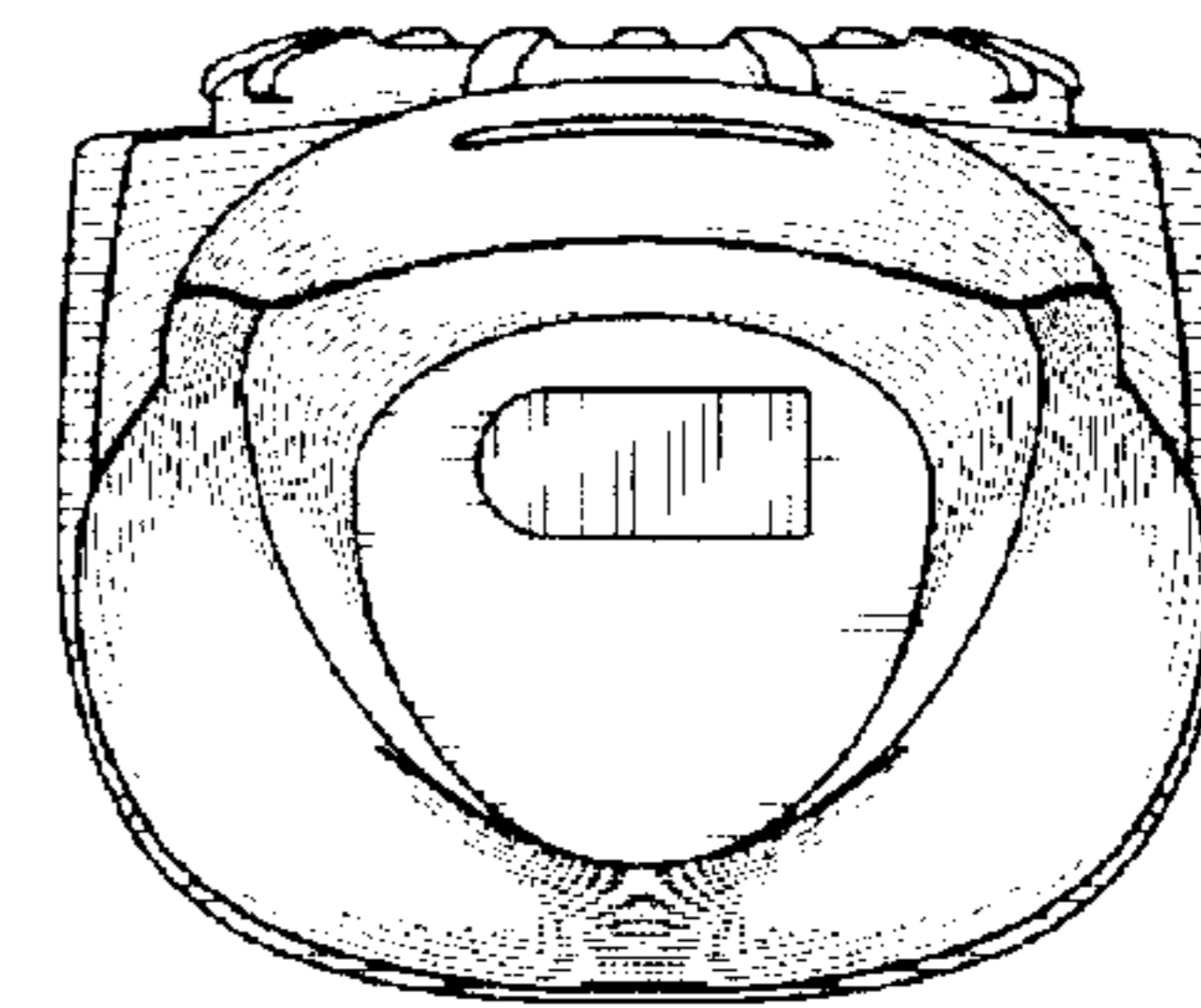
**FIG. 3**



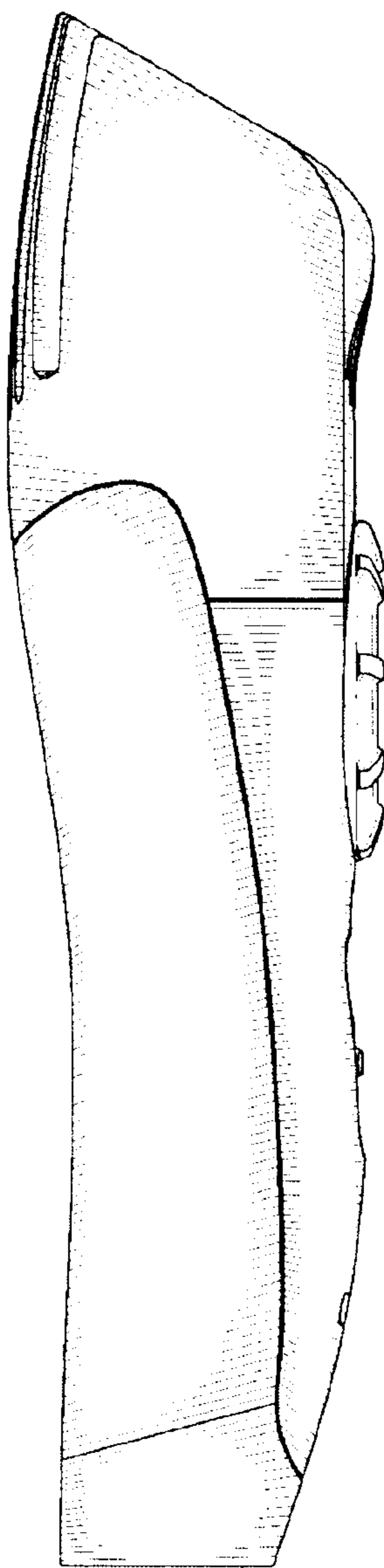
**FIG. 4**



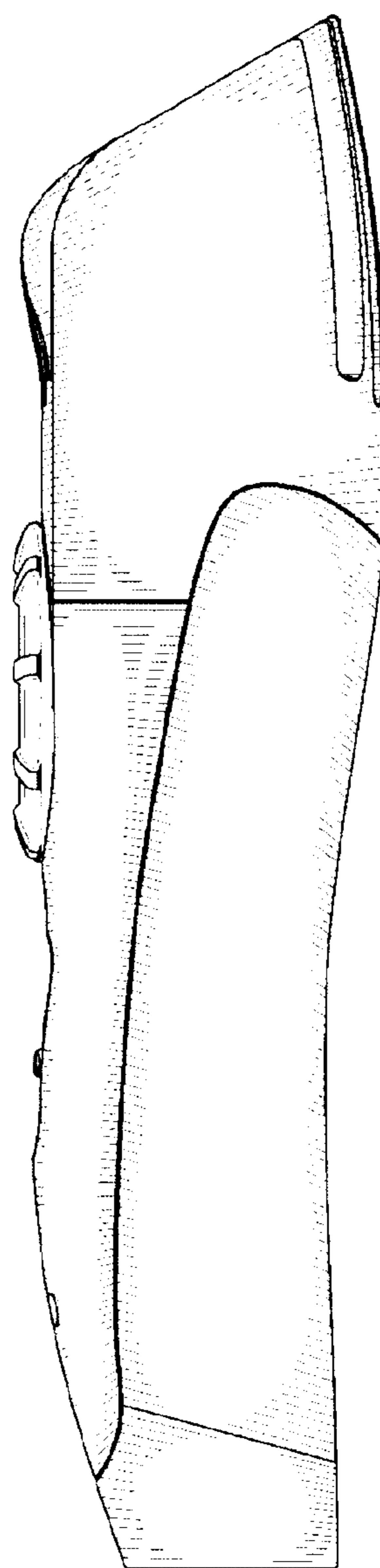
**FIG. 5**



**FIG. 6**



**FIG. 7**



**FIG. 8**