



US00D535785S

(12) **United States Design Patent**  
**Ullmann**

(10) **Patent No.:** **US D535,785 S**

(45) **Date of Patent:** **\*\* Jan. 23, 2007**

(54) **ELECTRIC SHAVER**

(75) Inventor: **Roland Ullmann**, Offenbach (DE)

(73) Assignee: **Braun GmbH**, Kromberg (DE)

(\*\*) Term: **14 Years**

(21) Appl. No.: **29/241,194**

(22) Filed: **Oct. 25, 2005**

(30) **Foreign Application Priority Data**

Jul. 26, 2005 (EM) ..... 000377460

(51) **LOC (8) Cl.** ..... **28-03**

(52) **U.S. Cl.** ..... **D28/51**

(58) **Field of Classification Search** ..... 30/32,  
30/34.05, 34.1, 34.2, 41-41.6, 43-43.92,  
30/44-45, 47-60, 526-533; D28/44-46,  
D28/49-53

See application file for complete search history.

(56) **References Cited**

**U.S. PATENT DOCUMENTS**

D407,532 S \* 3/1999 Jacobs ..... D28/51

D422,118 S \* 3/2000 Kitagawa et al. .... D28/51

D453,857 S \* 2/2002 Hara et al. .... D28/51

D495,091 S \* 8/2004 Ullmann ..... D28/49

D524,484 S \* 7/2006 Winkler et al. .... D28/49

\* cited by examiner

*Primary Examiner*—Jennifer Rivard

(74) *Attorney, Agent, or Firm*—Fish & Richardson P.C.

(57) **CLAIM**

The ornamental design for an electric shaver, as shown and described.

**DESCRIPTION**

FIG. 1 is a perspective view of an electric shaver from above, showing my new design;

FIG. 2 is a front view of the appliance thereof;

FIG. 3 is a side view of the appliance thereof;

FIG. 4 is a rear view of the appliance thereof;

FIG. 5 is a top plan view of the appliance thereof; and,

FIG. 6 is a bottom plan view of the appliance thereof.

**1 Claim, 5 Drawing Sheets**

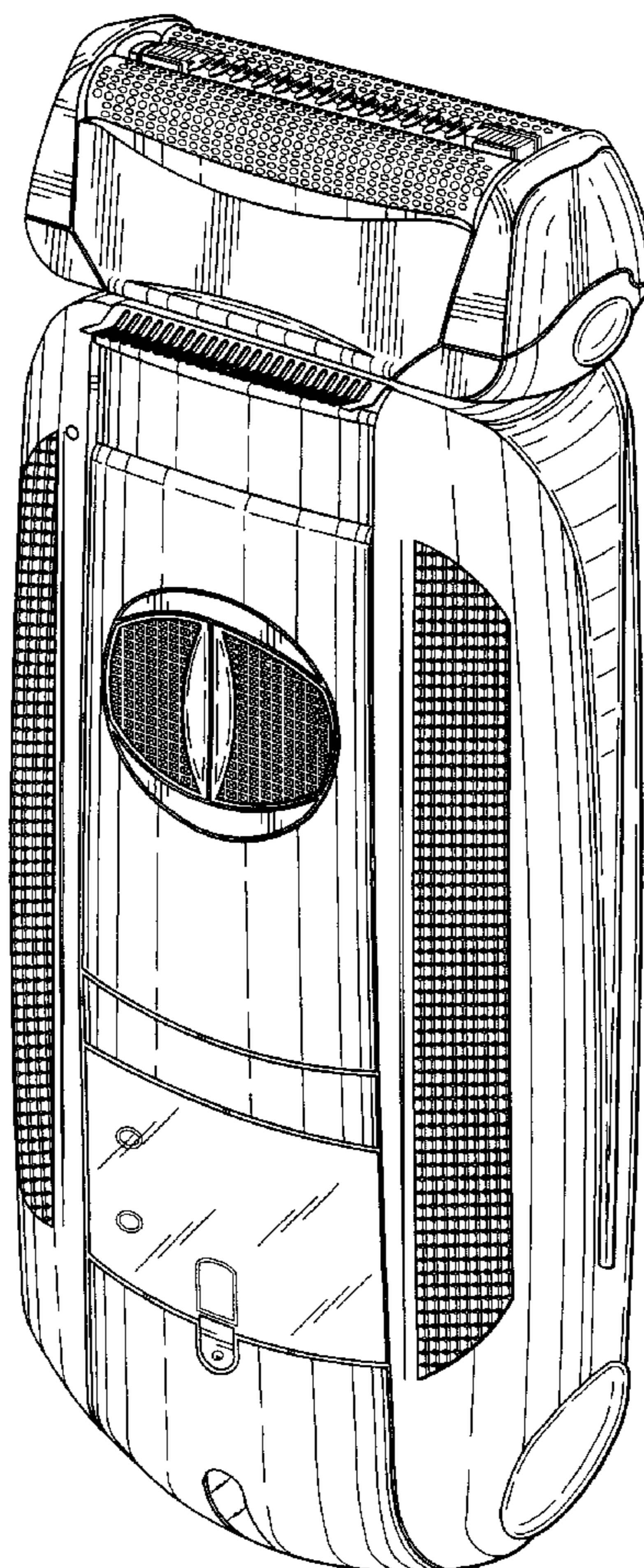

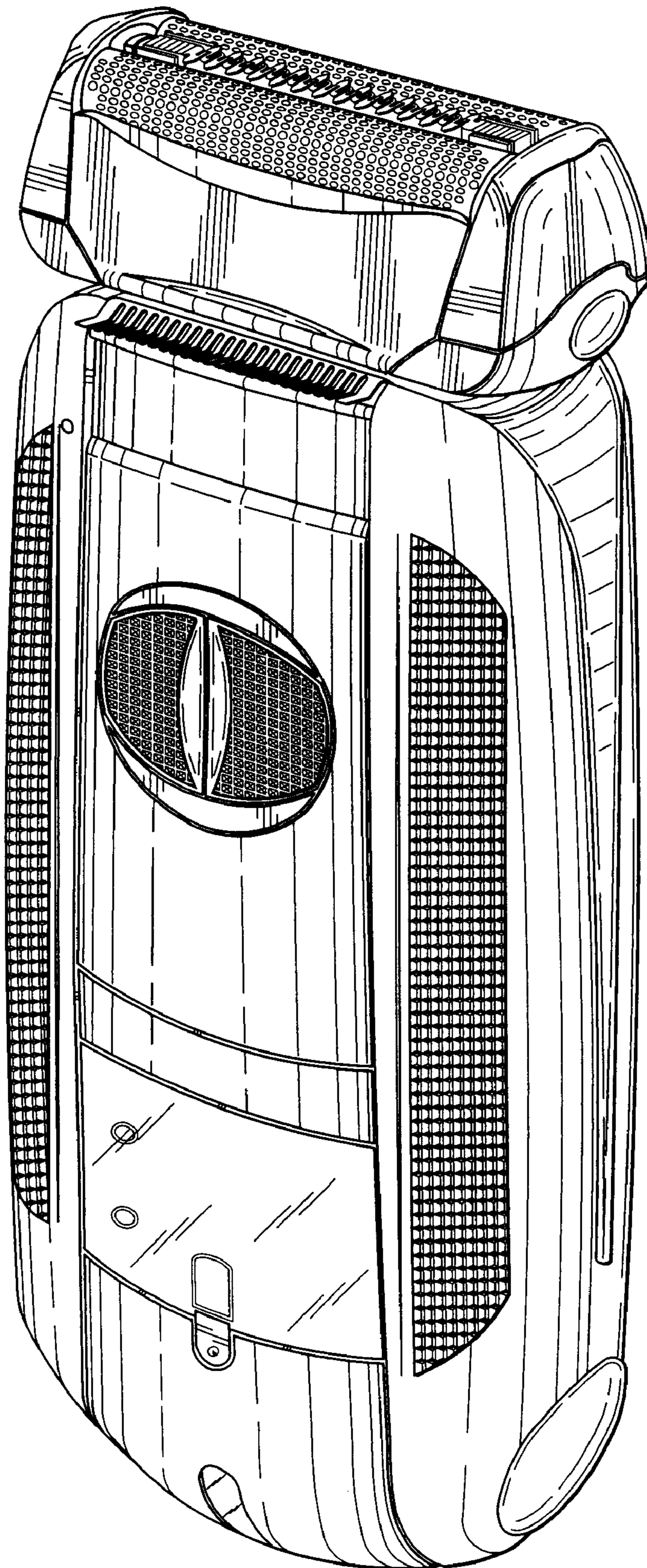

Fig. 1

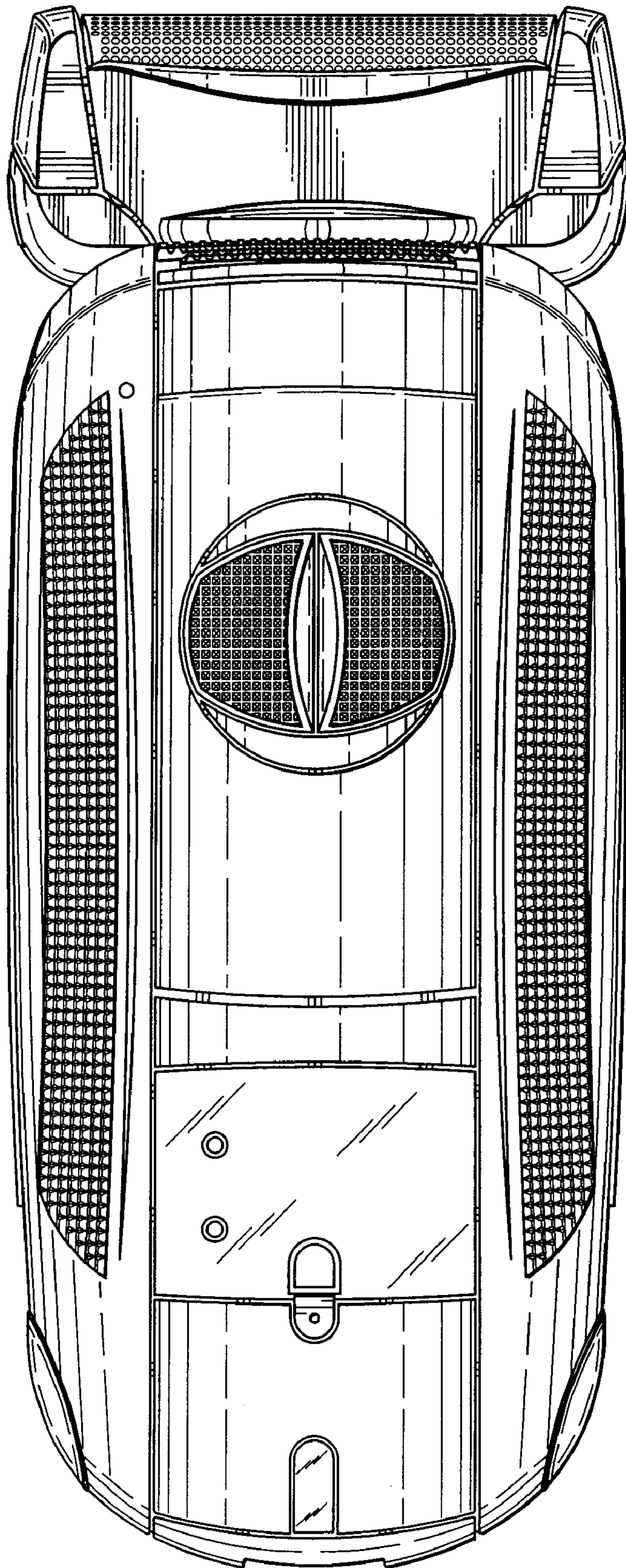

Fig. 2

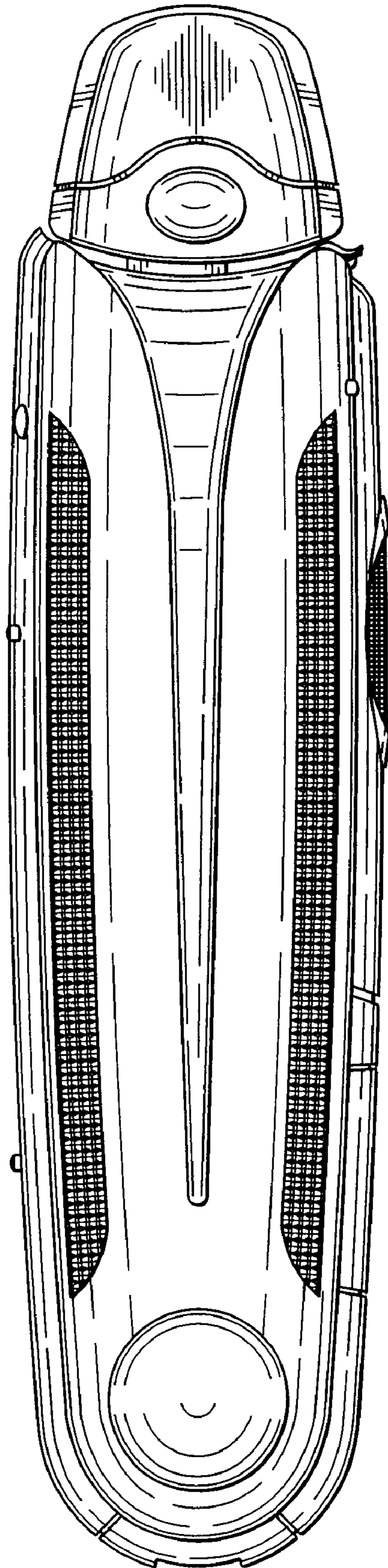

Fig. 3

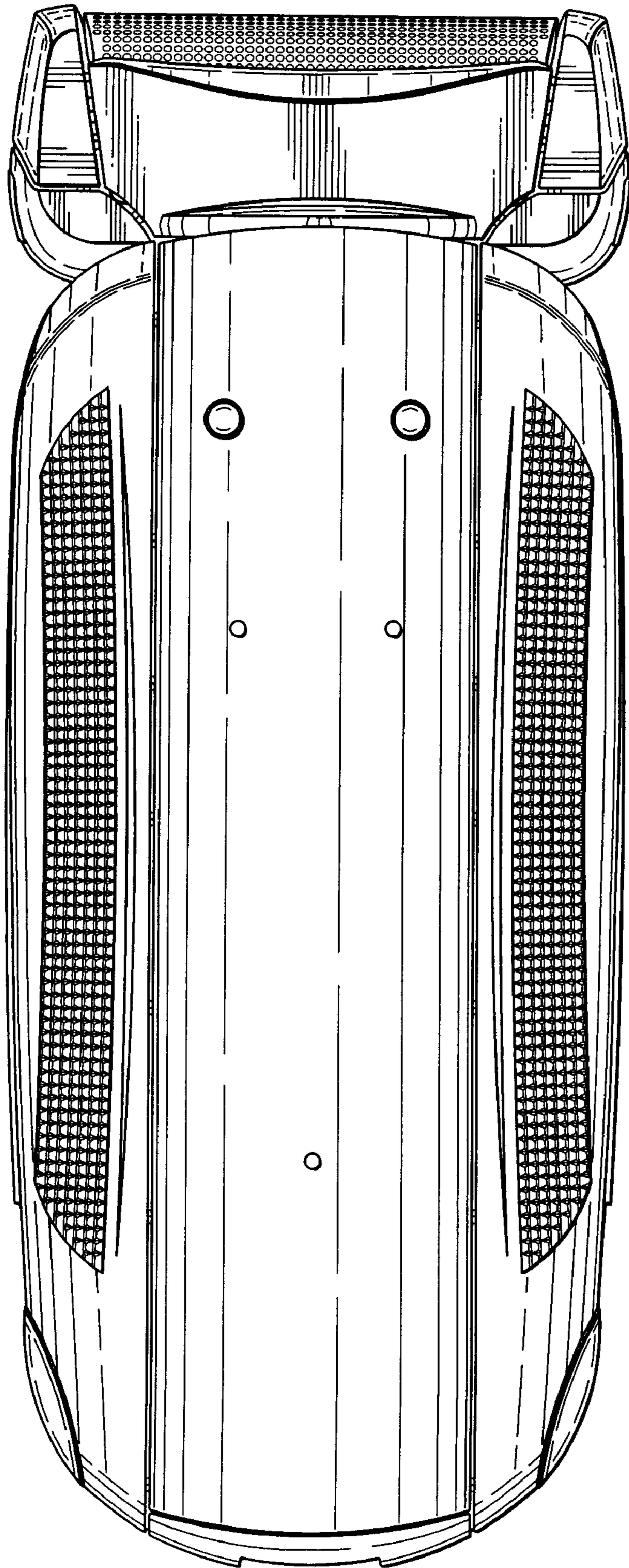

Fig. 4

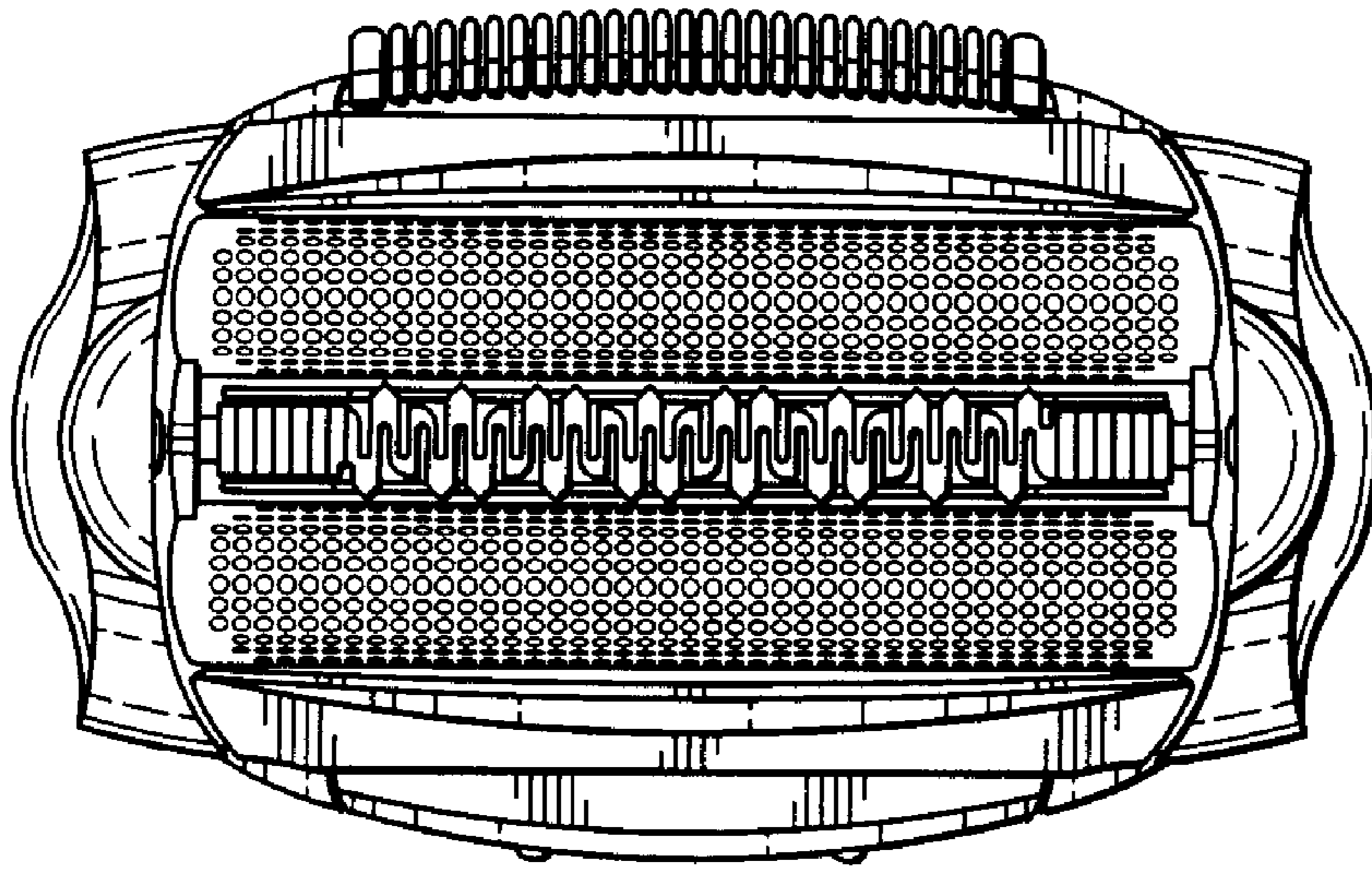

Fig. 5

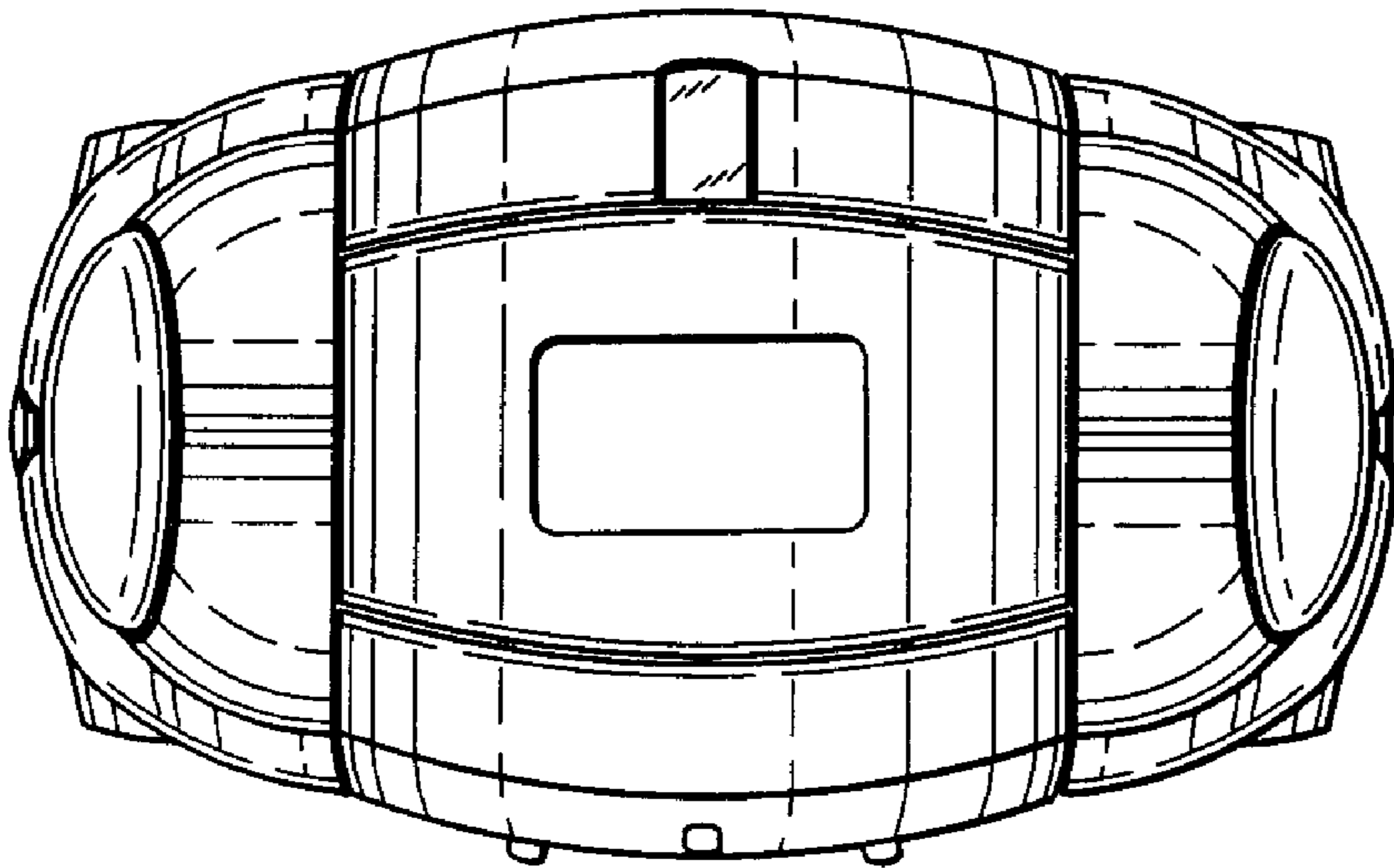

Fig. 6