

US00D535770S

(12) **United States Design Patent**
Yuen

(10) **Patent No.:** **US D535,770 S**

(45) **Date of Patent:** **** Jan. 23, 2007**

(54) **AIR IONIZER WITH DUST COLLECTOR
AND EMERGENCY LED FLASHLIGHT**

D493,318 S * 7/2004 Bauer et al. D6/552
D520,659 S * 5/2006 Yuen D26/38

(76) Inventor: **Se Kit Yuen**, 6/F, Yau Lee Centre, 45
Hoi Yuen Road, Kwun Tong, Kowloon
(HK)

* cited by examiner

Primary Examiner—Marcus A. Jackson
(74) *Attorney, Agent, or Firm*—Akerman Senterfitt

(**) Term: **14 Years**

(57) **CLAIM**

(21) Appl. No.: **29/240,924**

The ornamental design of an air ionizer with dust collector and emergency LED flashlight, as shown and described.

(22) Filed: **Oct. 20, 2005**

DESCRIPTION

(30) **Foreign Application Priority Data**

Apr. 22, 2005 (HK) 0500914

(51) **LOC (8) Cl.** **26-02**

(52) **U.S. Cl.** **D26/38**

(58) **Field of Classification Search** D26/37-50;
362/157, 158, 171-174, 183-208

See application file for complete search history.

FIG. 1 is a perspective front view of the air ionizer with dust collector and emergency LED flashlight;
FIG. 2 is a perspective rear view, bottom view and left side view thereof;
FIG. 3 is a front view thereof;
FIG. 4 is a rear view thereof;
FIG. 5 is a left side view thereof;
FIG. 6 is a right side view thereof;
FIG. 7 is a top view thereof; and,
FIG. 8 is bottom view thereof.

(56) **References Cited**

U.S. PATENT DOCUMENTS

D431,661 S * 10/2000 Yuen D26/38

1 Claim, 7 Drawing Sheets

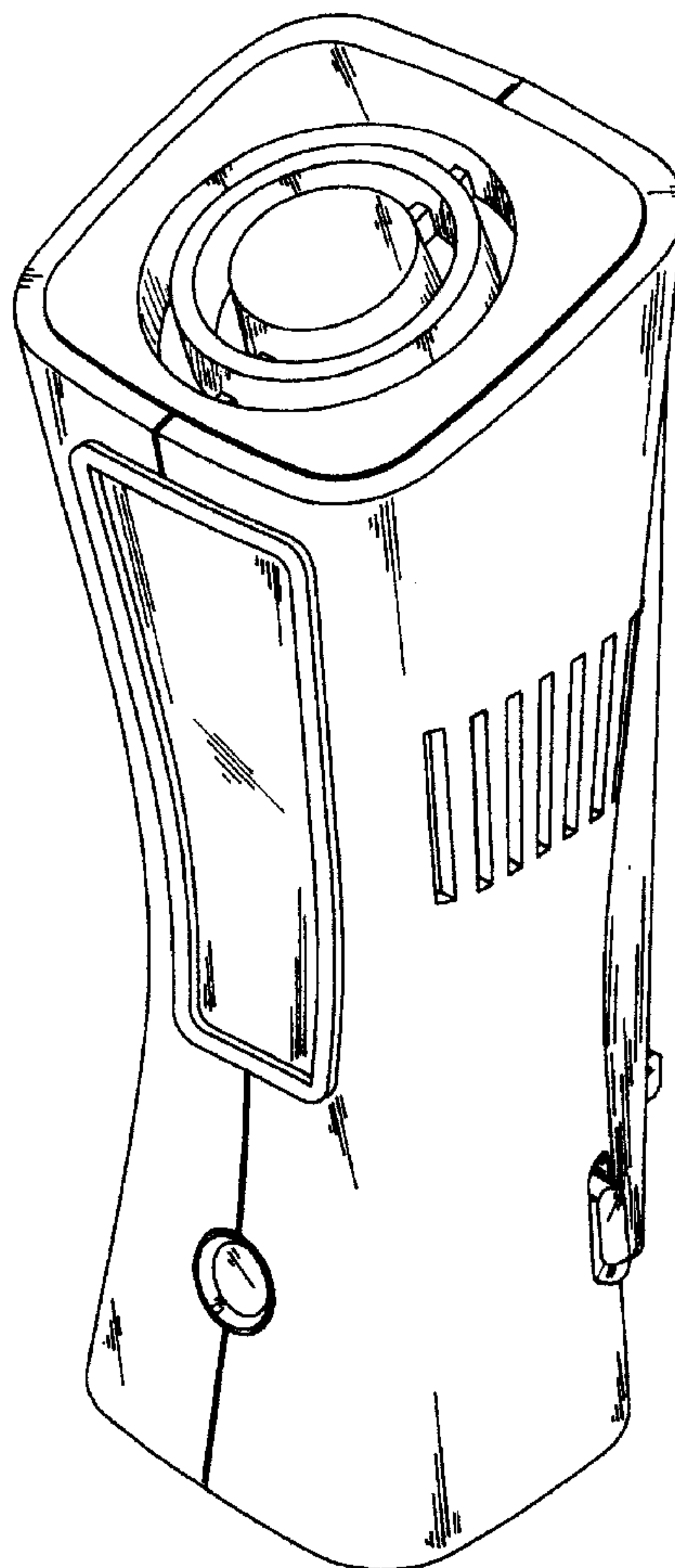

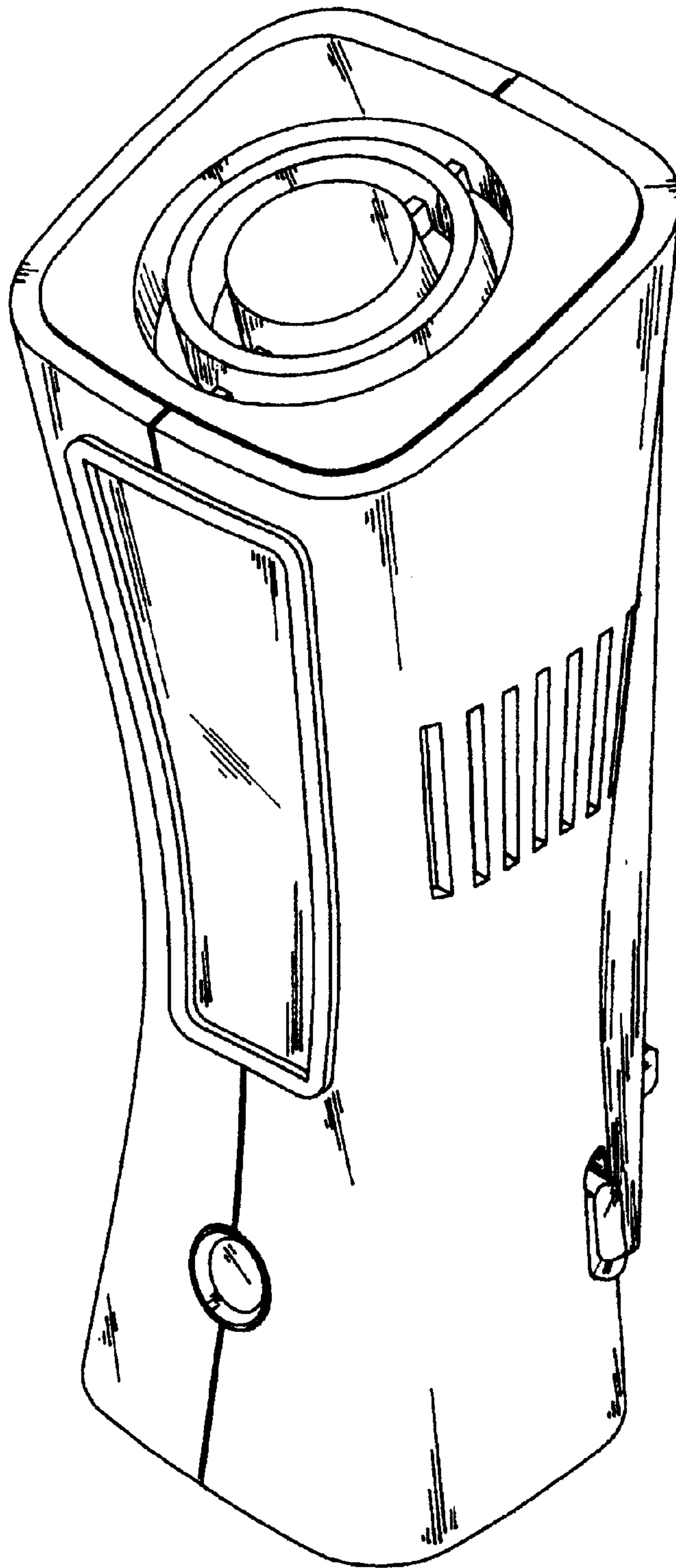

FIG. 1

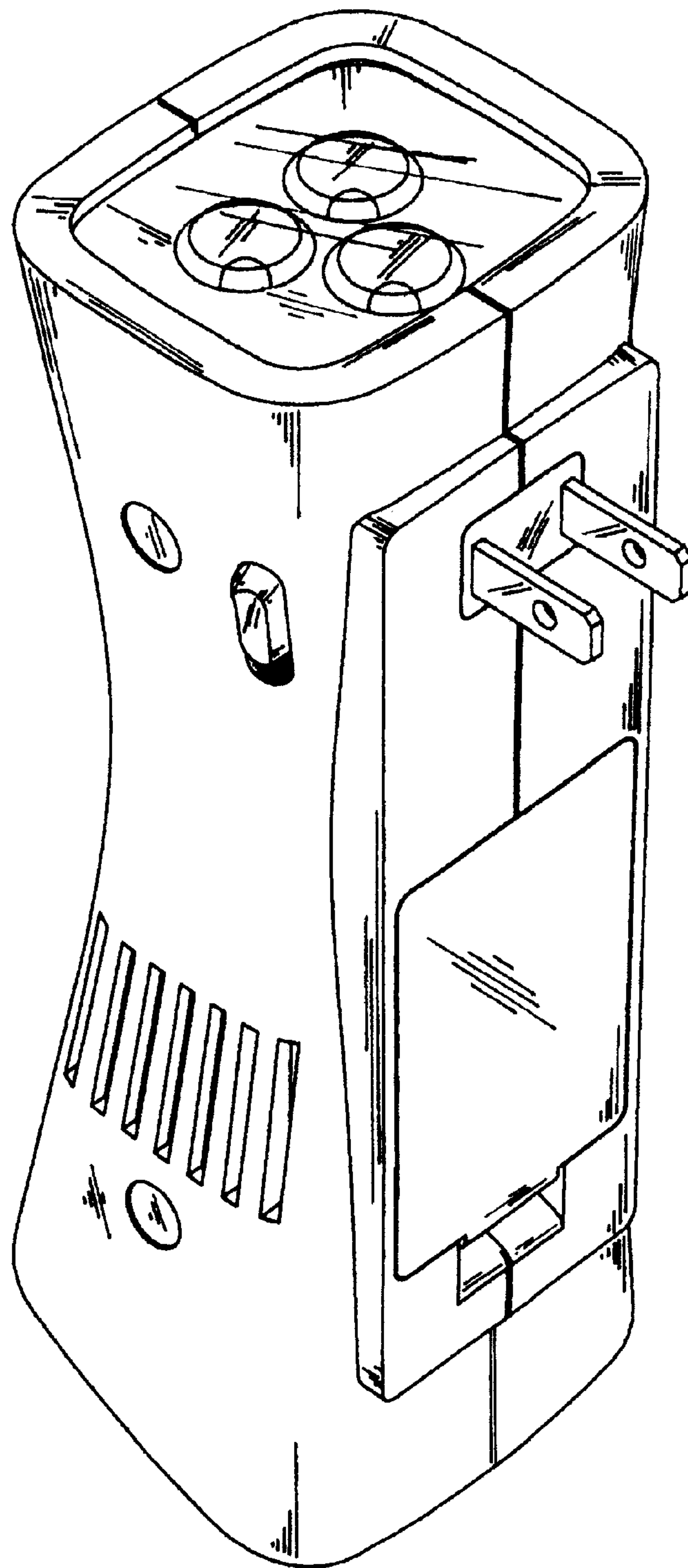

FIG. 2

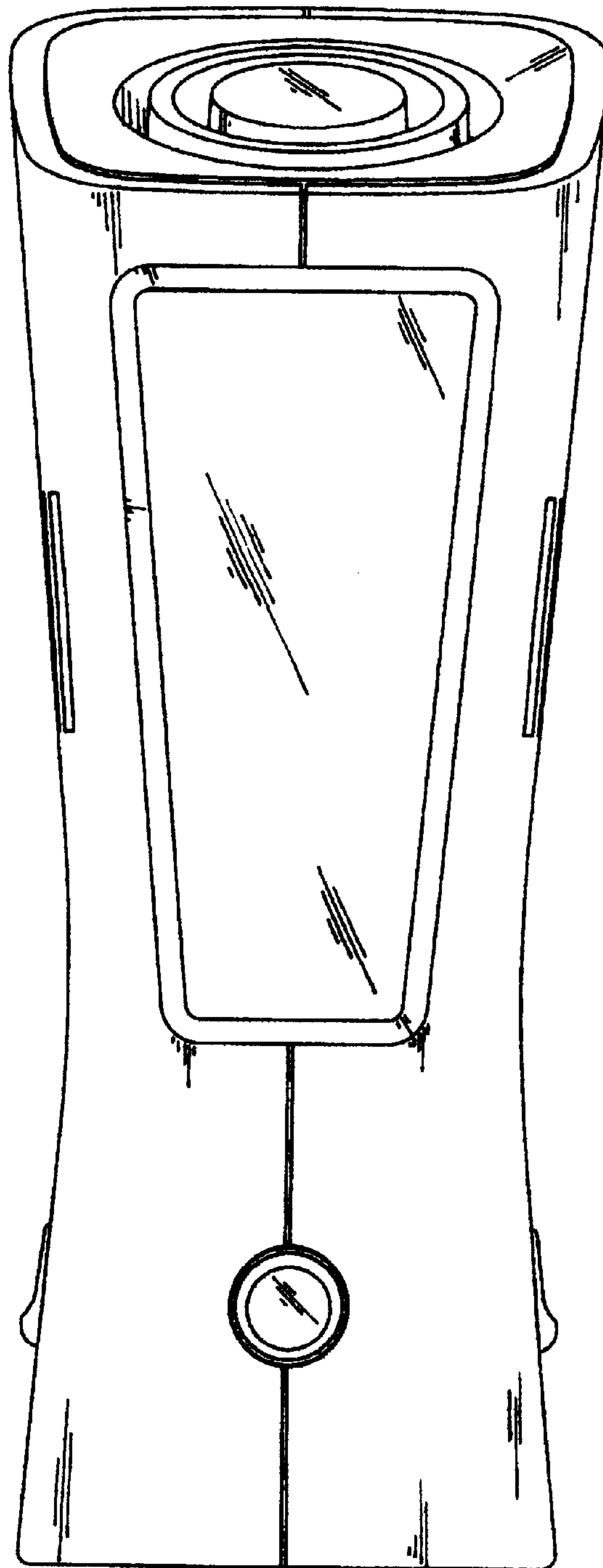

FIG. 3

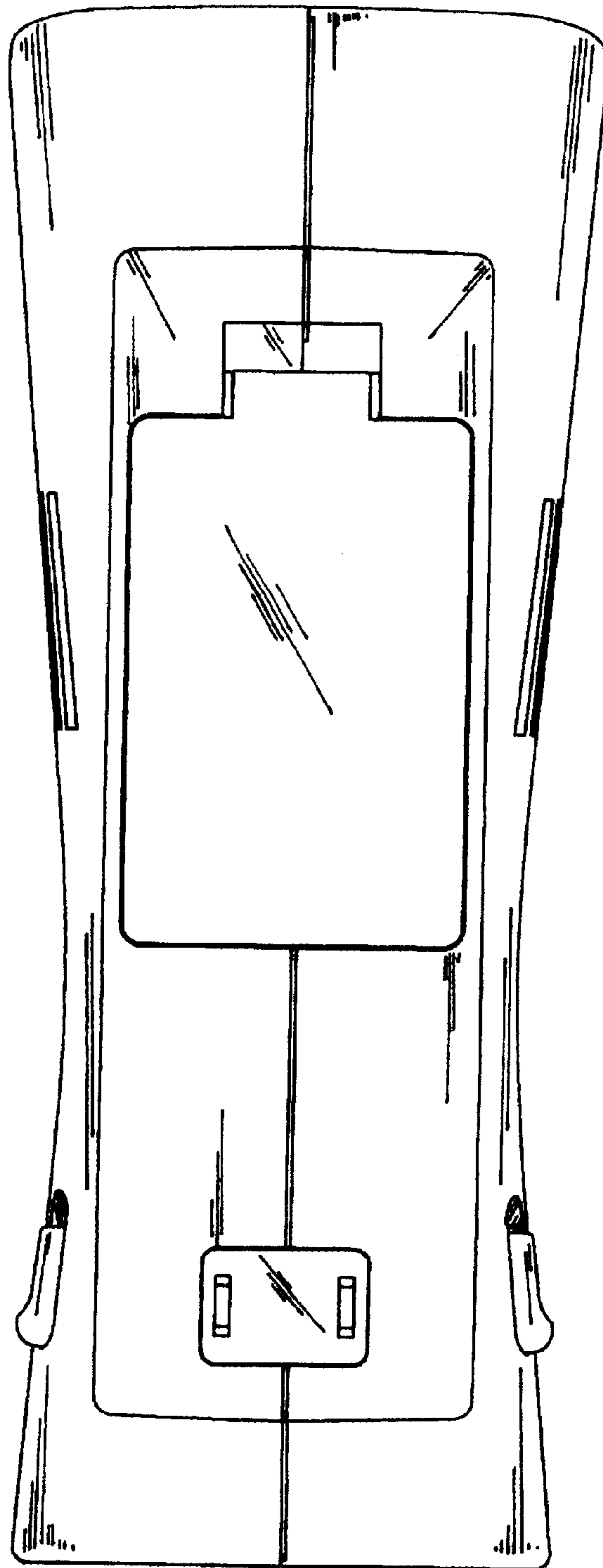

FIG. 4

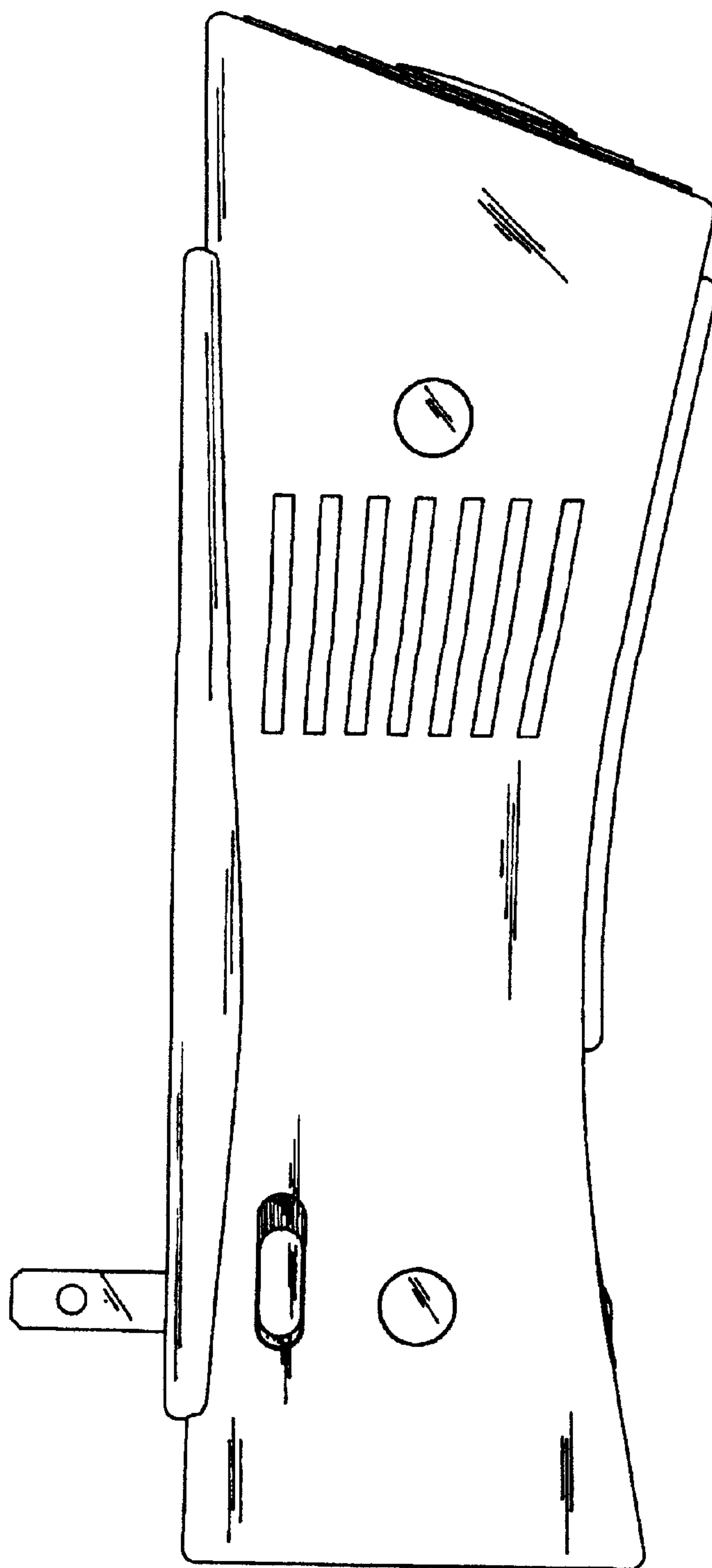

FIG. 5

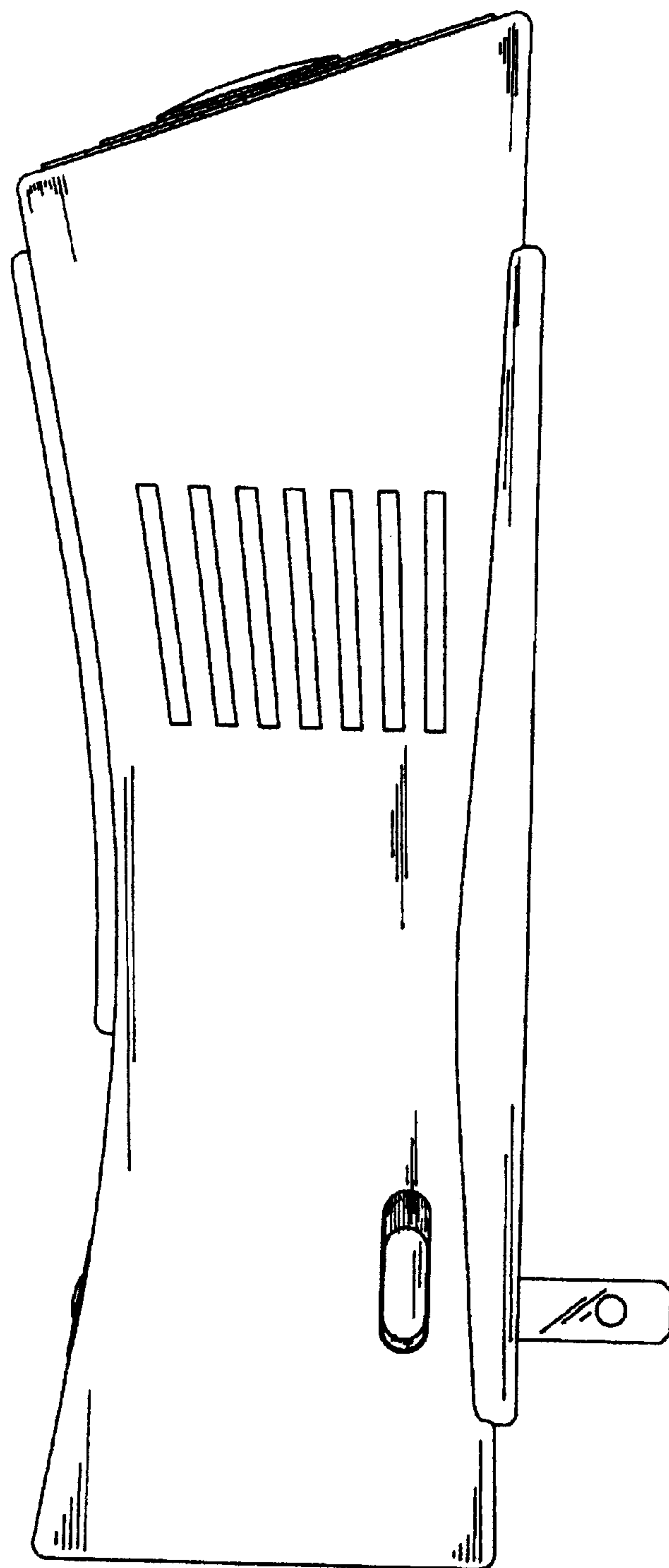

FIG. 6

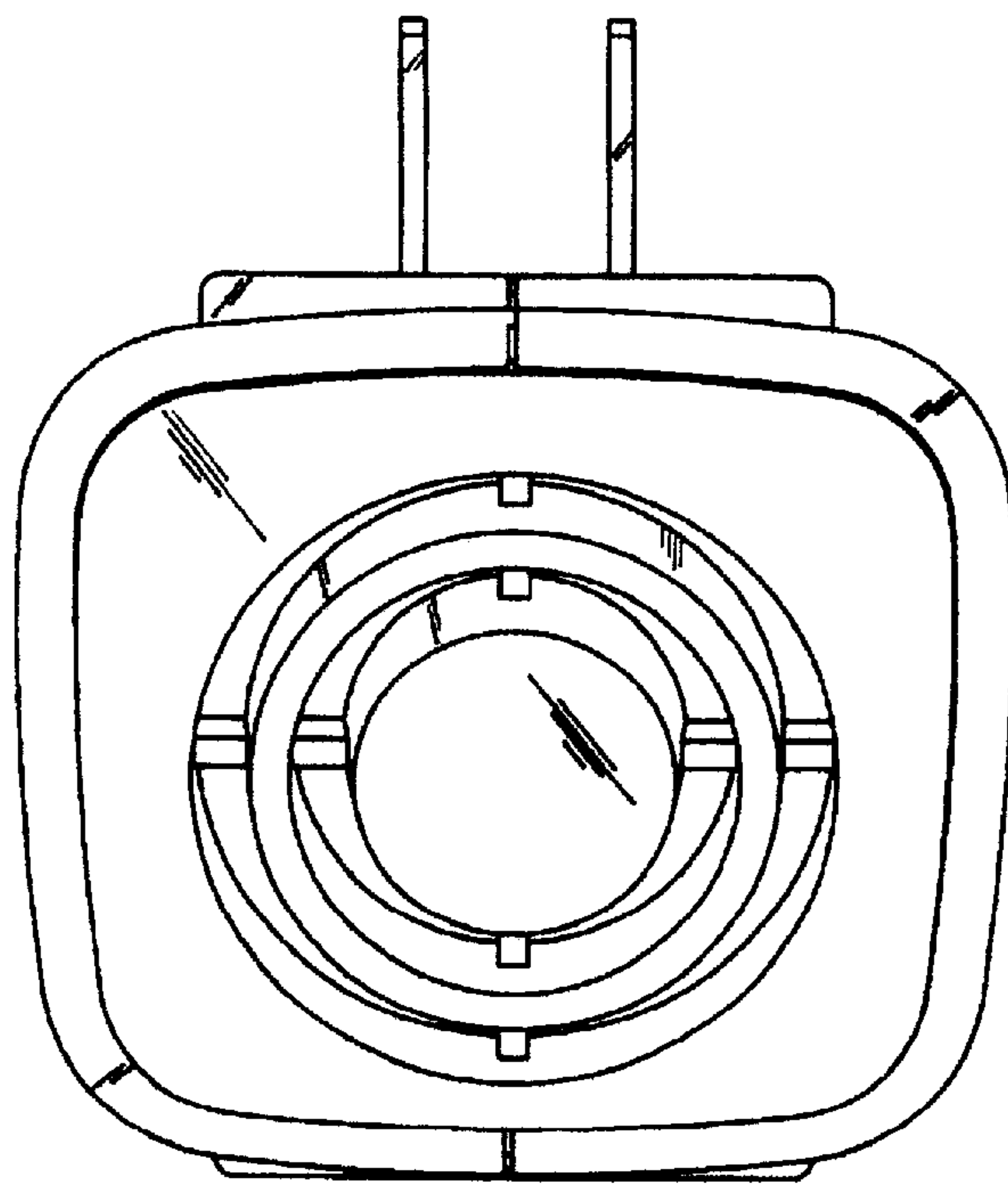

FIG. 7

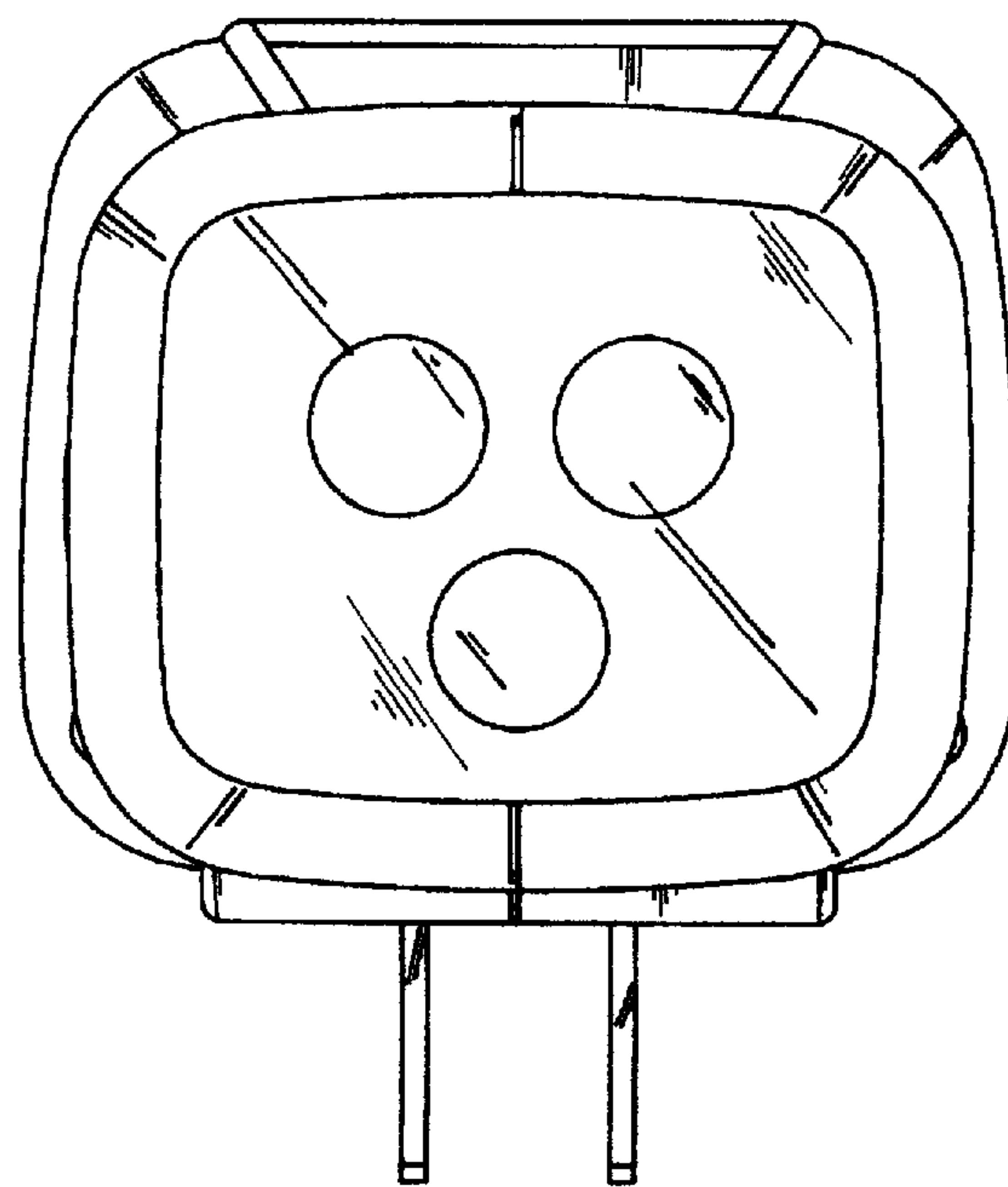

FIG. 8