



US00D535747S

(12) **United States Design Patent**
Isogimi

(10) **Patent No.:** **US D535,747 S**

(45) **Date of Patent:** **** Jan. 23, 2007**

(54) **SURGICAL KNIFE**

(75) Inventor: **Kazuhiko Isogimi**, Seki (JP)

(73) Assignee: **Kai R & D Center Co., Ltd.**, Gifu-ken (JP)

(**) Term: **14 Years**

(21) Appl. No.: **29/200,087**

(22) Filed: **Feb. 24, 2004**

(30) **Foreign Application Priority Data**

Sep. 5, 2003 (JP) 2003-026059

(51) **LOC (8) Cl.** **24-02**

(52) **U.S. Cl.** **D24/146; D24/147**

(58) **Field of Classification Search** D24/146,
D24/147; 606/166, 4, 5
See application file for complete search history.

(56) **References Cited**

U.S. PATENT DOCUMENTS

5,002,565	A	3/1991	McGregor	
5,217,476	A *	6/1993	Wishinsky	606/167
5,217,477	A *	6/1993	Lager	606/167
5,352,233	A *	10/1994	Anis	606/167
D370,532	S *	6/1996	Epstein et al.	D24/146
D405,178	S	2/1999	Dykes	
6,056,764	A *	5/2000	Smith	606/167
RE37,304	E	7/2001	Van Heugten et al.	
6,554,840	B1 *	4/2003	Matsutani et al.	606/107
D483,489	S *	12/2003	Scheller et al.	D24/146
6,966,921	B1 *	11/2005	Scheller et al.	606/166

FOREIGN PATENT DOCUMENTS

JP	S-794880	9/1990
JP	S-949594	3/1996
JP	S-949594-1	11/1996
JP	A-H09-276284	10/1997
JP	S-949594-2	5/1998
JP	S-794880-1	12/1999
JP	S-1121174	9/2001
JP	A-2001-238890	9/2001

* cited by examiner

Primary Examiner—Ian Simmons

Assistant Examiner—Christopher Lee

(74) *Attorney, Agent, or Firm*—Posz Law Group, PLC

(57) **CLAIM**

The ornamental design for a surgical knife, as shown and described.

DESCRIPTION

FIG. 1 is a perspective view of a surgical knife of the present invention;

FIG. 2 is a front view thereof, the rear view being a mirror image of FIG. 2;

FIG. 3 is a top plan view thereof;

FIG. 4 is a bottom plan view thereof;

FIG. 5 is a right side view thereof;

FIG. 6 is a left side view thereof;

FIG. 7 is a cross-sectional view taken along line 7—7 of FIG. 3;

FIG. 8 is an enlarged perspective view of the blade of FIG. 1;

FIG. 9 is an enlarged front view of the blade of FIG. 2;

FIG. 10 is an enlarged top plan view of the blade of FIG. 3;

FIG. 11 is an enlarged bottom plan view of the blade of FIG. 4;

FIG. 12 is an enlarged cross-sectional view of the blade of FIG. 7;

FIG. 13 is an enlarged cross-sectional view taken along line 13—13 of FIG. 10;

FIG. 14 is an enlarged cross-sectional view taken along line 14—14 of FIG. 10;

FIG. 15 is an enlarged cross-sectional view taken along line 15—15 of FIG. 10;

FIG. 16 is an enlarged cross-sectional view taken along line 16—16 of FIG. 10; and,

FIG. 17 is an enlarged cross-sectional view taken along line 17—17 of FIG. 10.

The broken lines in FIGS. 1 through 7 are shown for illustrative purposes only and form no part of the claimed design.

1 Claim, 7 Drawing Sheets

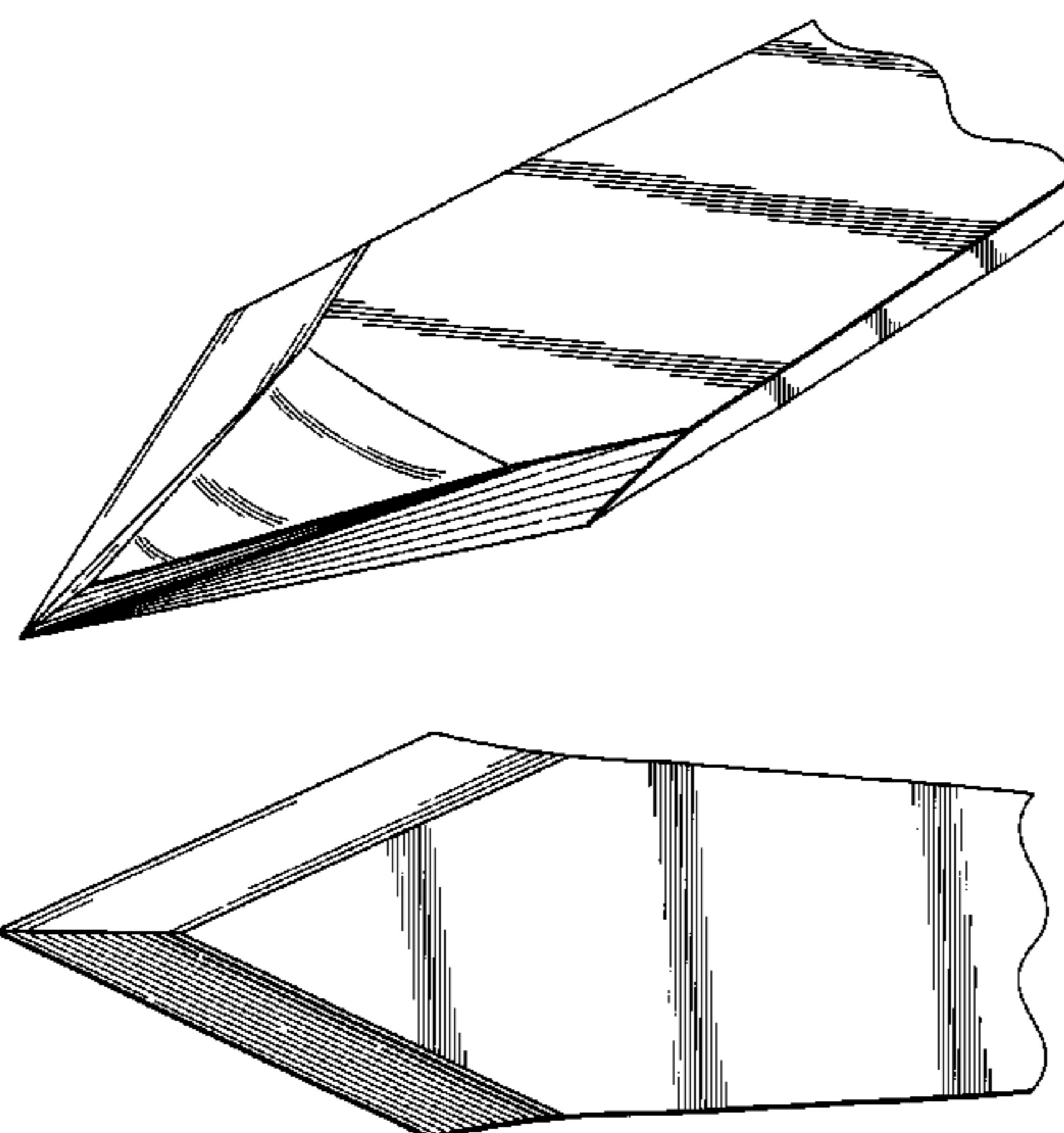

Fig.1

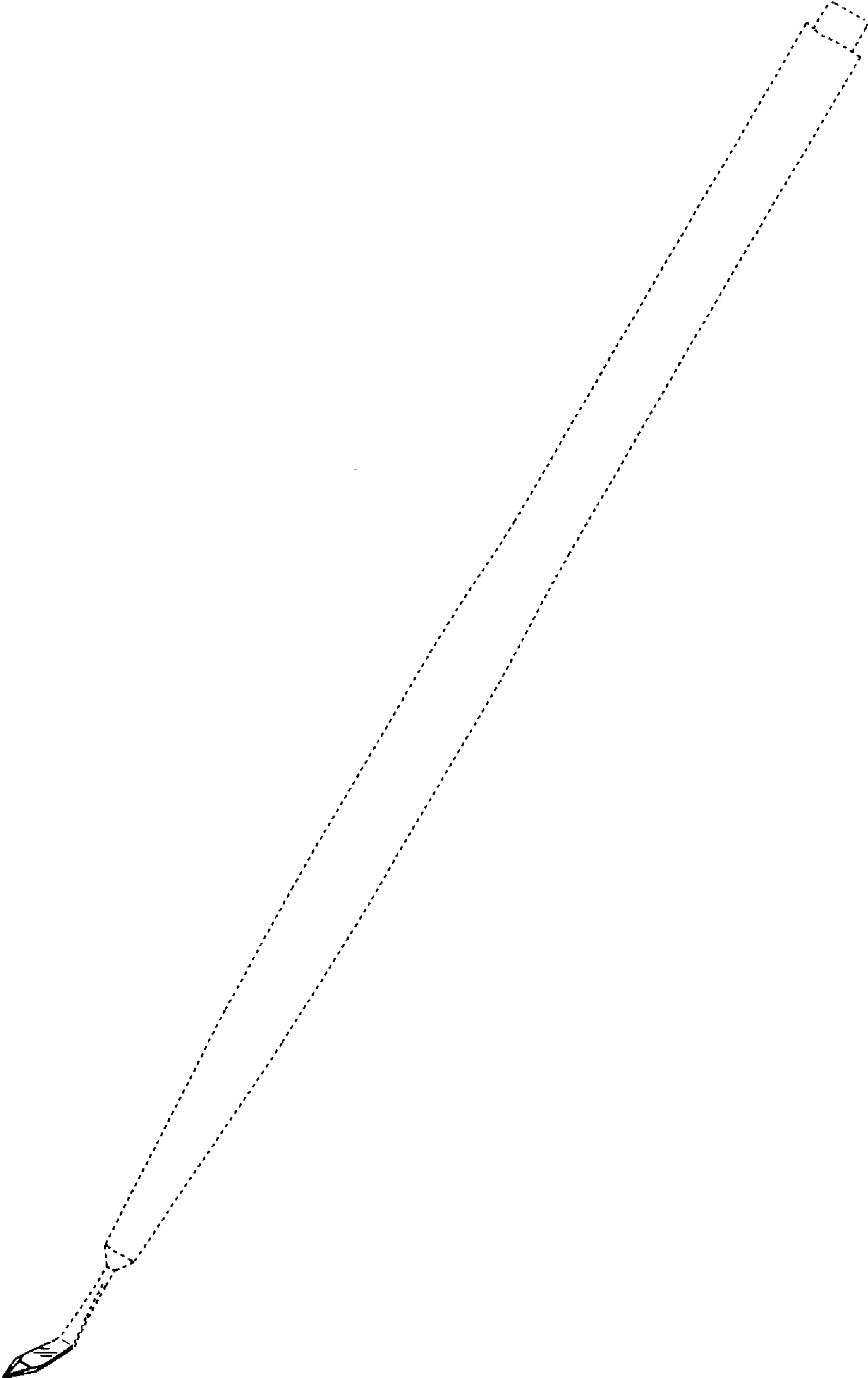

Fig.2

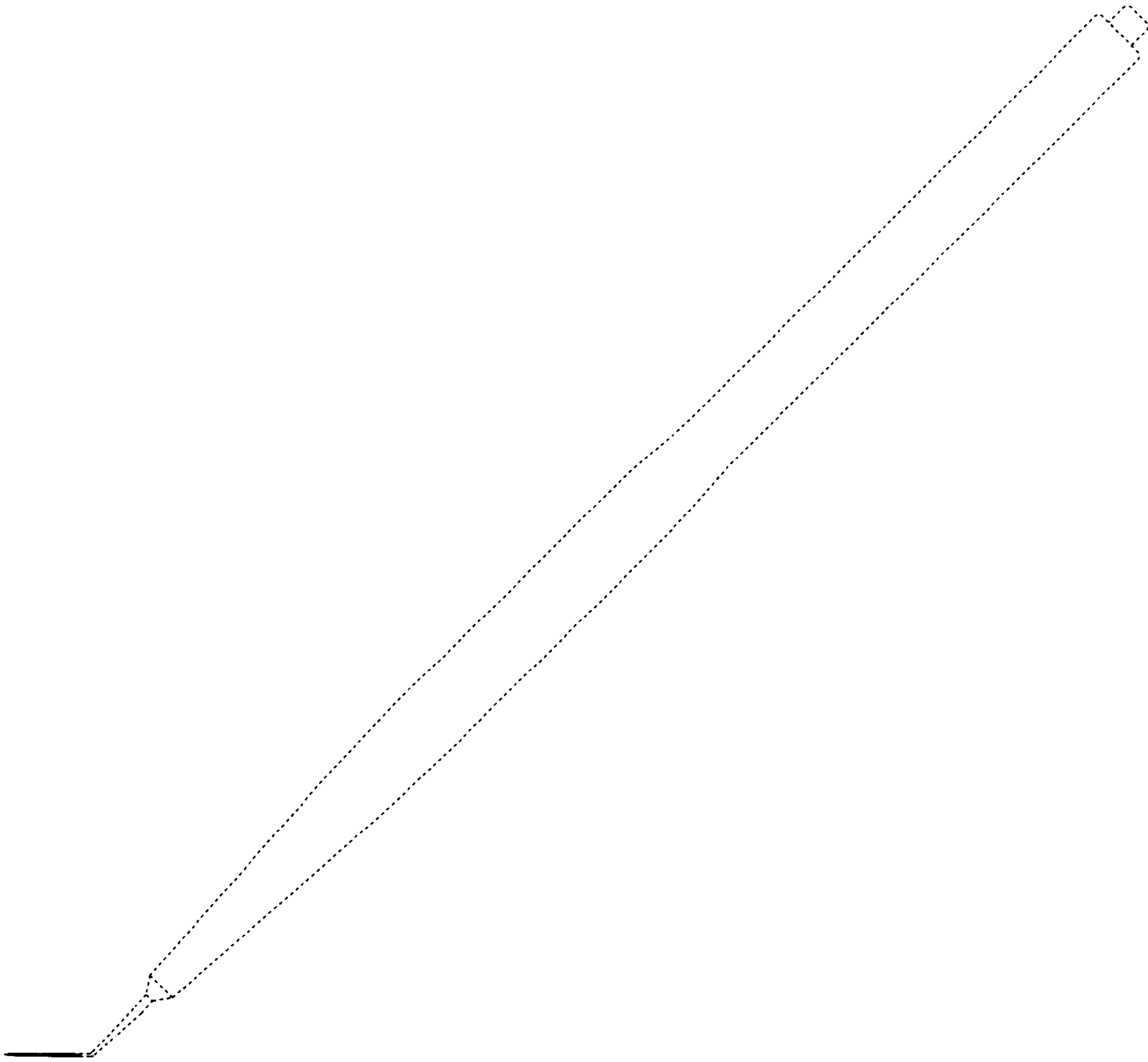

Fig.3

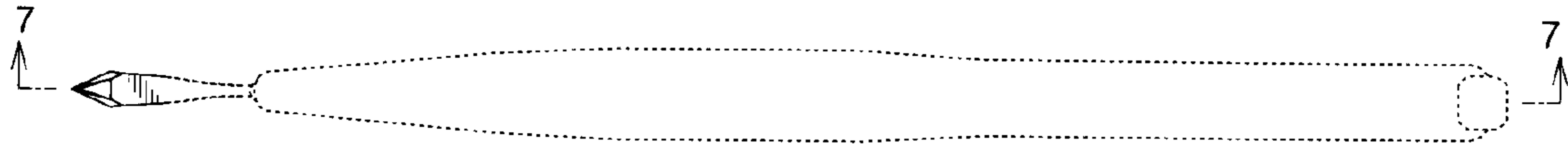

Fig.4



Fig.5

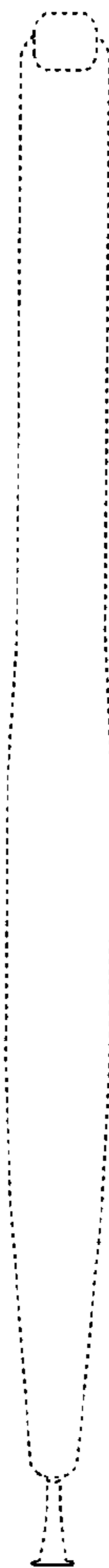

Fig.6

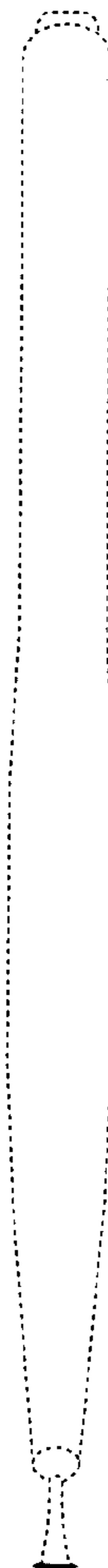

Fig.7

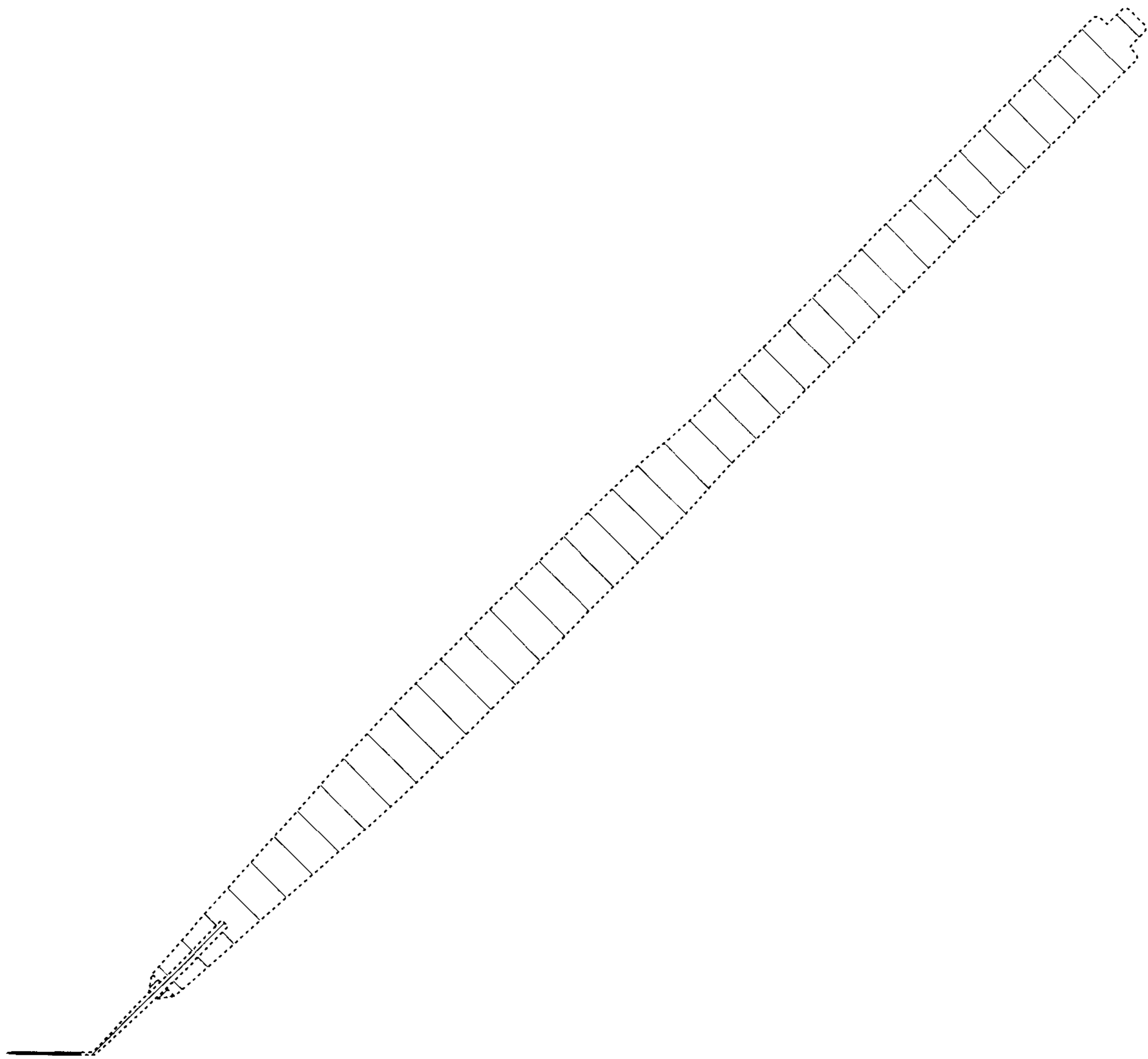

Fig.8

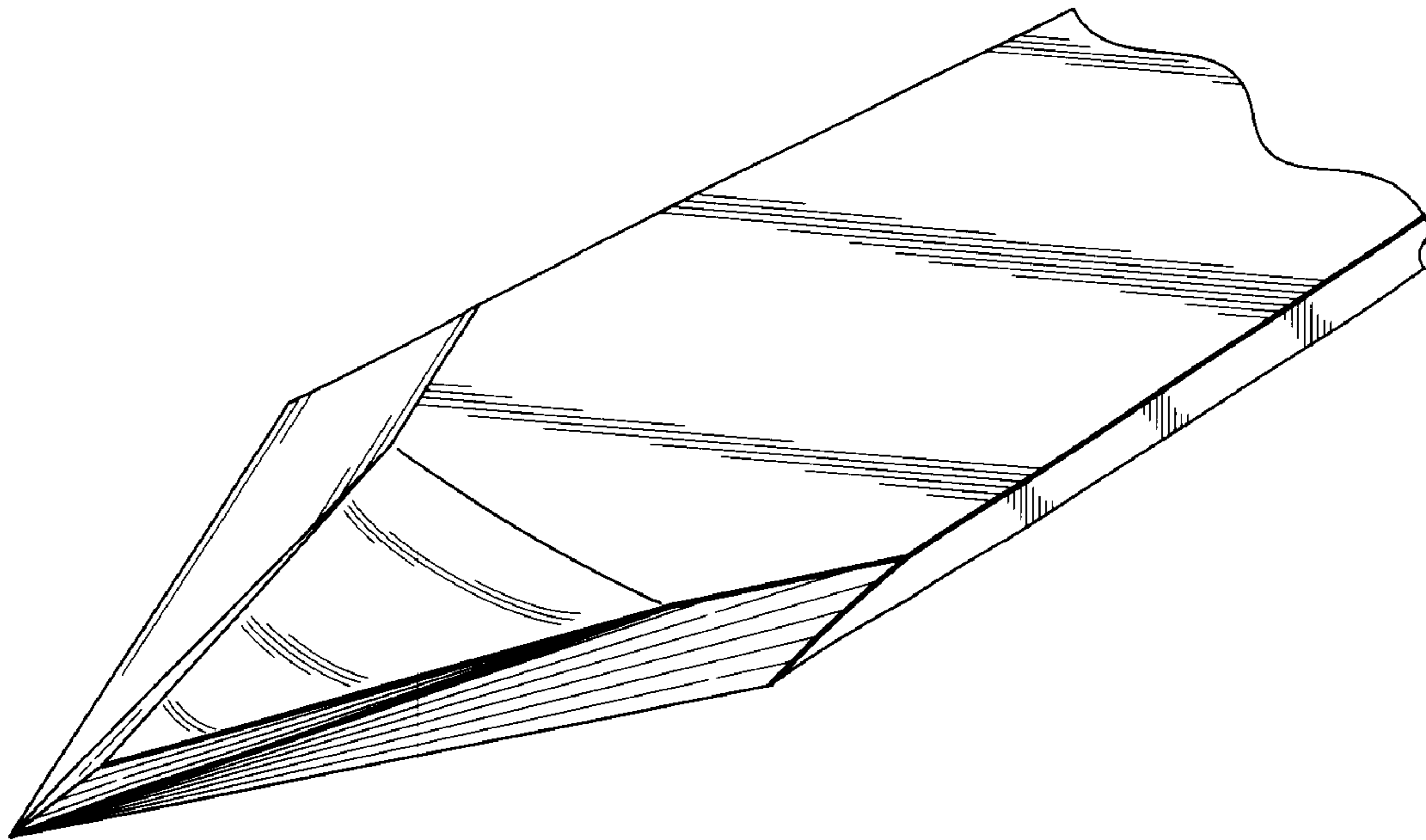

Fig.9

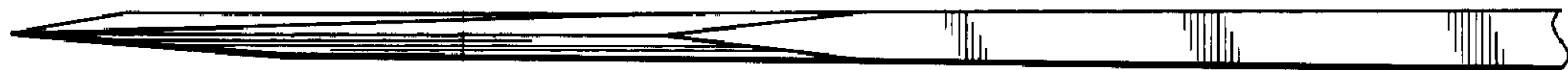

Fig.10

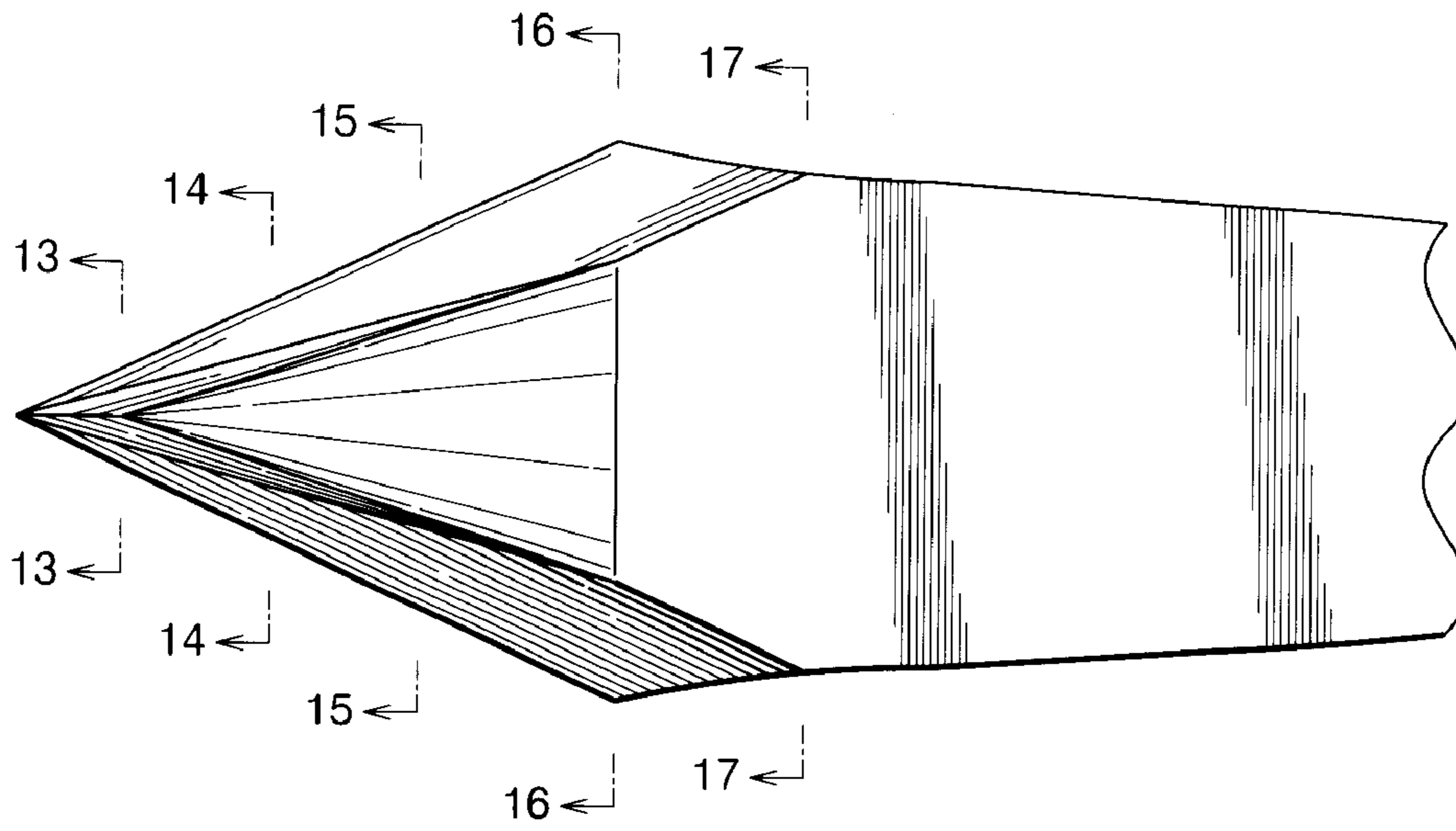

Fig.11

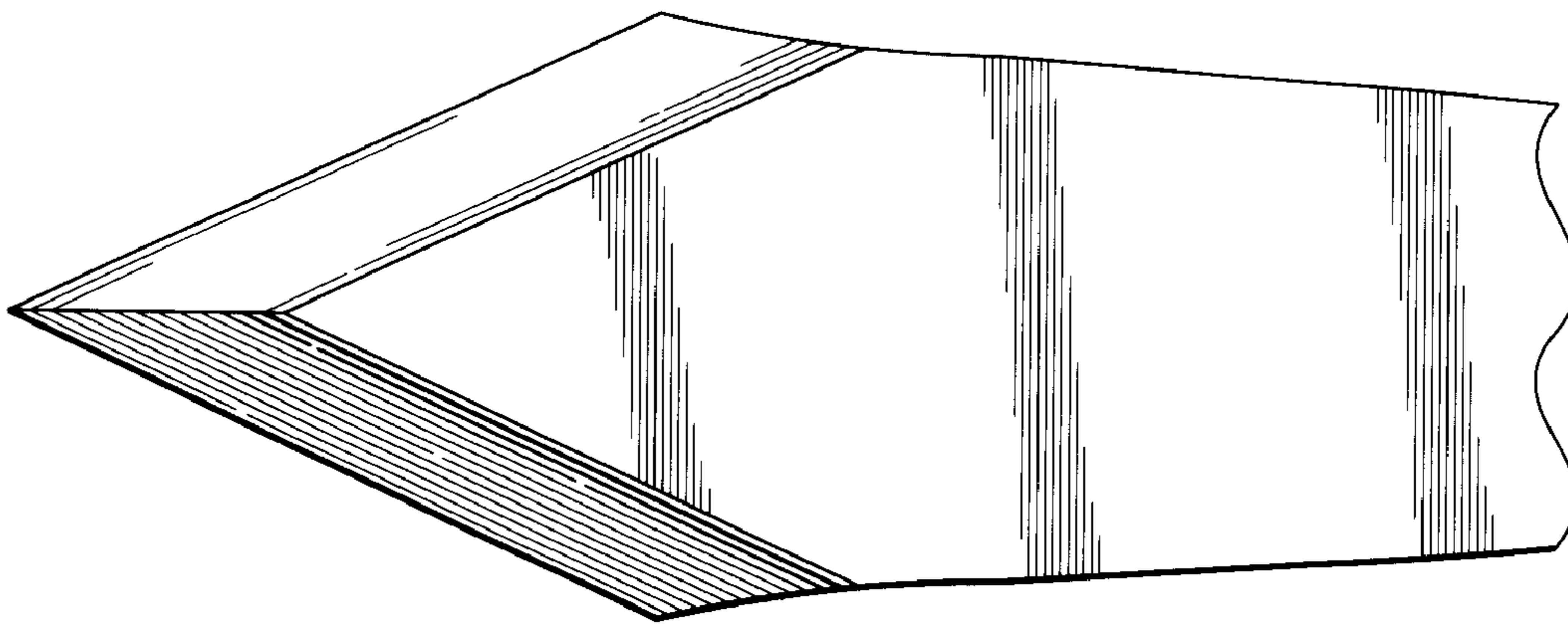

Fig.12

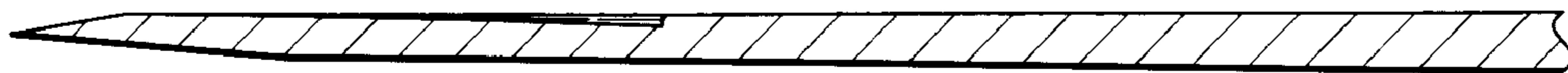

Fig.13



Fig.14

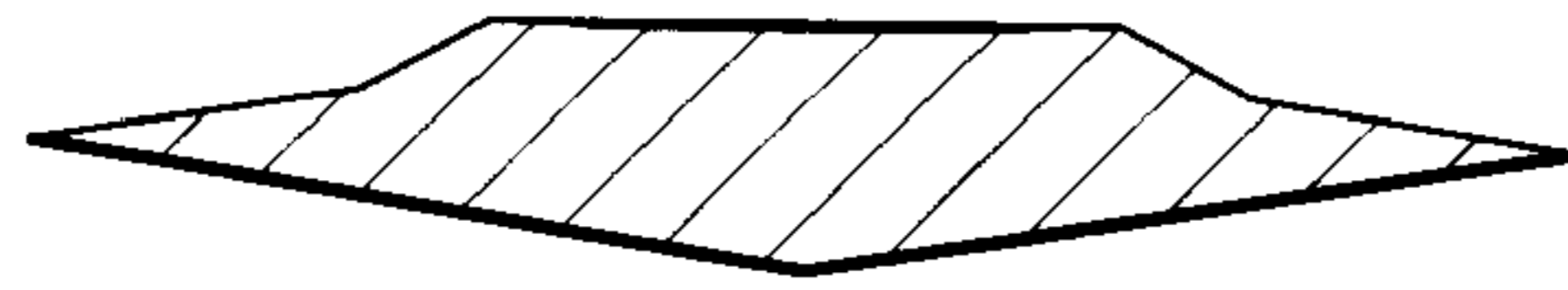

Fig.15

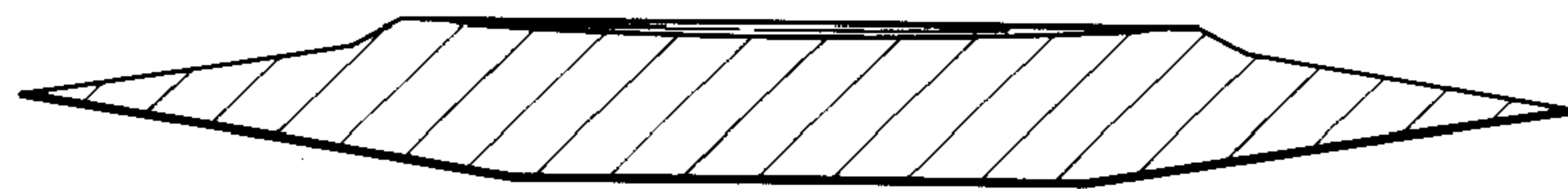

Fig.16



Fig.17

