



US00D535712S

(12) **United States Design Patent**  
**Toroussian**

(10) **Patent No.:** **US D535,712 S**

(45) **Date of Patent:** **\*\* Jan. 23, 2007**

(54) **PUTTER HEAD**

(75) Inventor: **Vartan Toroussian**, Montreal (CA)

(73) Assignee: **Daito Precision Inc.**, Saint-Laurent (CA)

(\*\*) Term: **14 Years**

(21) Appl. No.: **29/252,198**

(22) Filed: **Jan. 19, 2006**

(51) **LOC (8) Cl.** ..... **21-02**

(52) **U.S. Cl.** ..... **D21/749**

(58) **Field of Classification Search** ..... D21/736-746,  
D21/759; 473/324-331, 251-256, 340, 341  
See application file for complete search history.

(56) **References Cited**

U.S. PATENT DOCUMENTS

D207,227 S *	3/1967	Solheim	.....	D21/739
4,458,900 A	7/1984	Antonious	.....	273/164
D360,670 S	7/1995	Nilsson	.....	D21/219
D389,207 S *	1/1998	Cameron	.....	D21/742
D426,599 S *	6/2000	Morgan et al.	.....	D21/736
D443,906 S *	6/2001	Hettinger et al.	.....	D21/743
D449,085 S *	10/2001	Breier et al.	.....	D21/744
D485,320 S *	1/2004	Breier et al.	.....	D21/736
D498,276 S *	11/2004	Schweigert et al.	.....	D21/743
6,949,028 B1	9/2005	Hueber	.....	473/242

\* cited by examiner

Primary Examiner—Mitchell Siegel

(74) *Attorney, Agent, or Firm*—Norris, McLaughlin & Marcus

(57) **CLAIM**

The ornamental design for a putter head, as shown and described.

**DESCRIPTION**

FIG. 1 is a back view of a putter head showing a first embodiment of my new design;  
 FIG. 2 is a bottom view of the putter head of FIG. 1;  
 FIG. 3 is a top view of the putter head of FIG. 1;  
 FIG. 4 is a back perspective view of the putter head of FIG. 1;  
 FIG. 5 is a toe perspective view of the putter head of FIG. 1;  
 FIG. 6 is a heel perspective view of the putter head of FIG. 1;  
 FIG. 7 is a face side view of the putter head of FIG. 1;  
 FIG. 8 is a back view of a putter head showing a second embodiment of my new design;  
 FIG. 9 is a bottom view of the putter head of FIG. 8;  
 FIG. 10 is a top view of the putter head of FIG. 8;  
 FIG. 11 is a back perspective view of the putter head of FIG. 8;  
 FIG. 12 is a toe perspective view of the putter head of FIG. 8;  
 FIG. 13 is a heel perspective view of the putter head of FIG. 8; and,  
 FIG. 14 is a face side view of the putter head of FIG. 8.

**1 Claim, 14 Drawing Sheets**

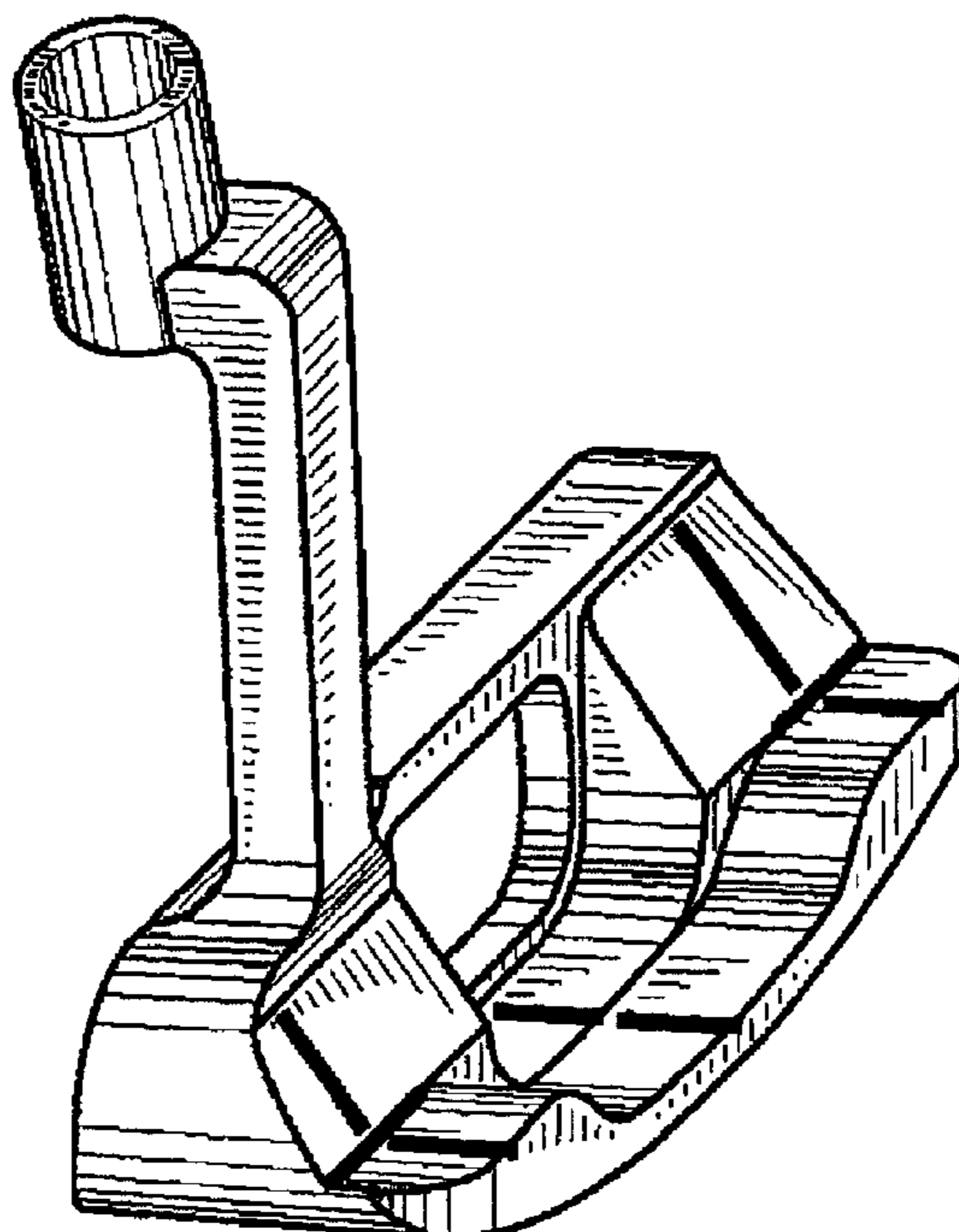
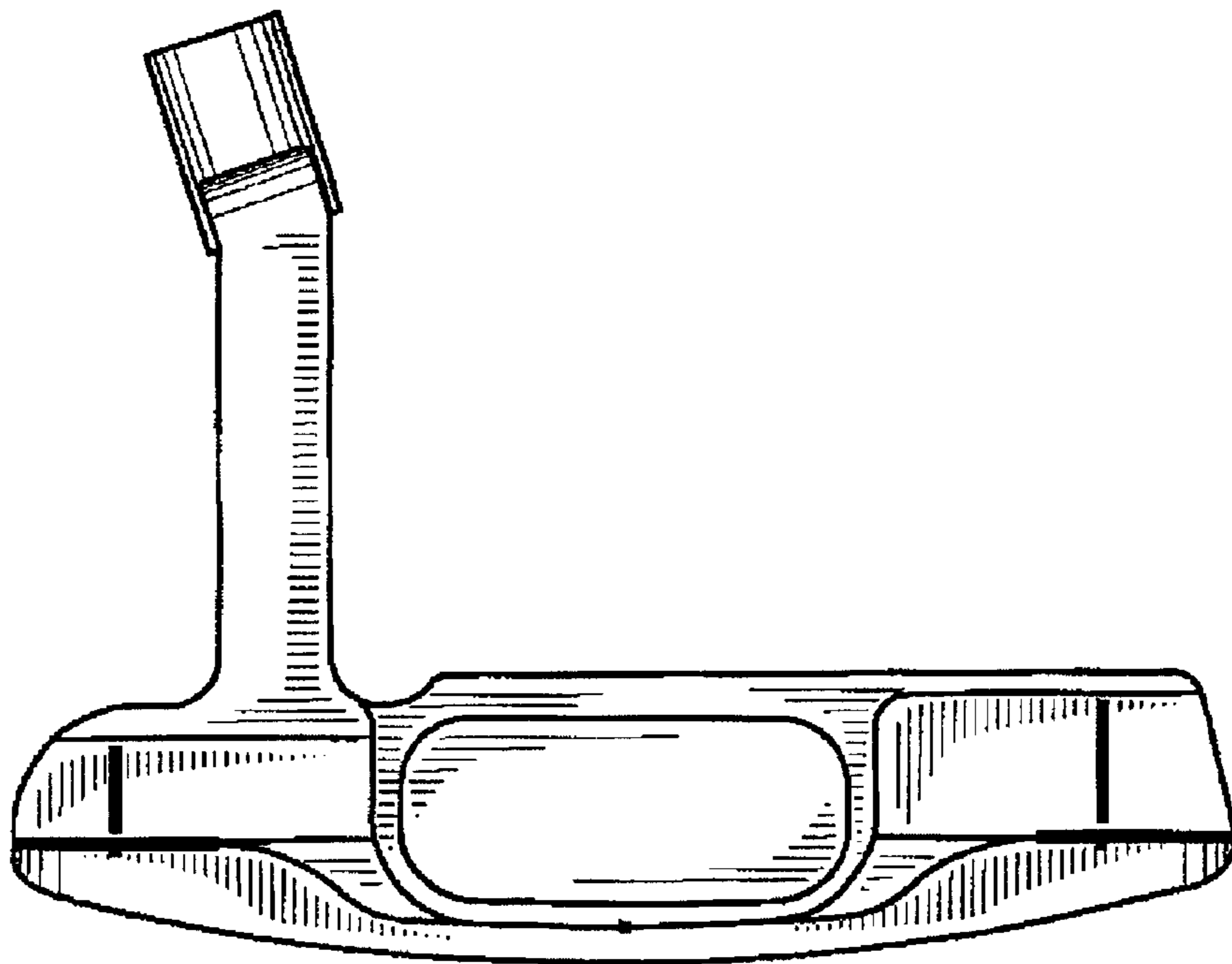


FIG. 1



**FIG. 2**

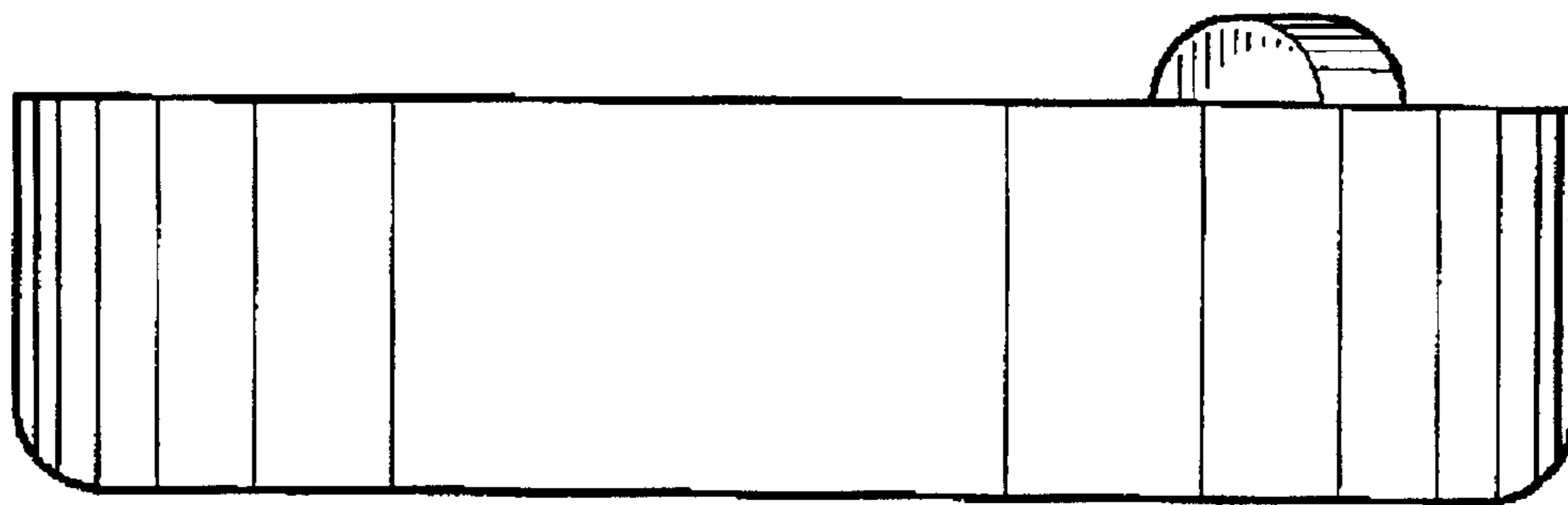


FIG. 3

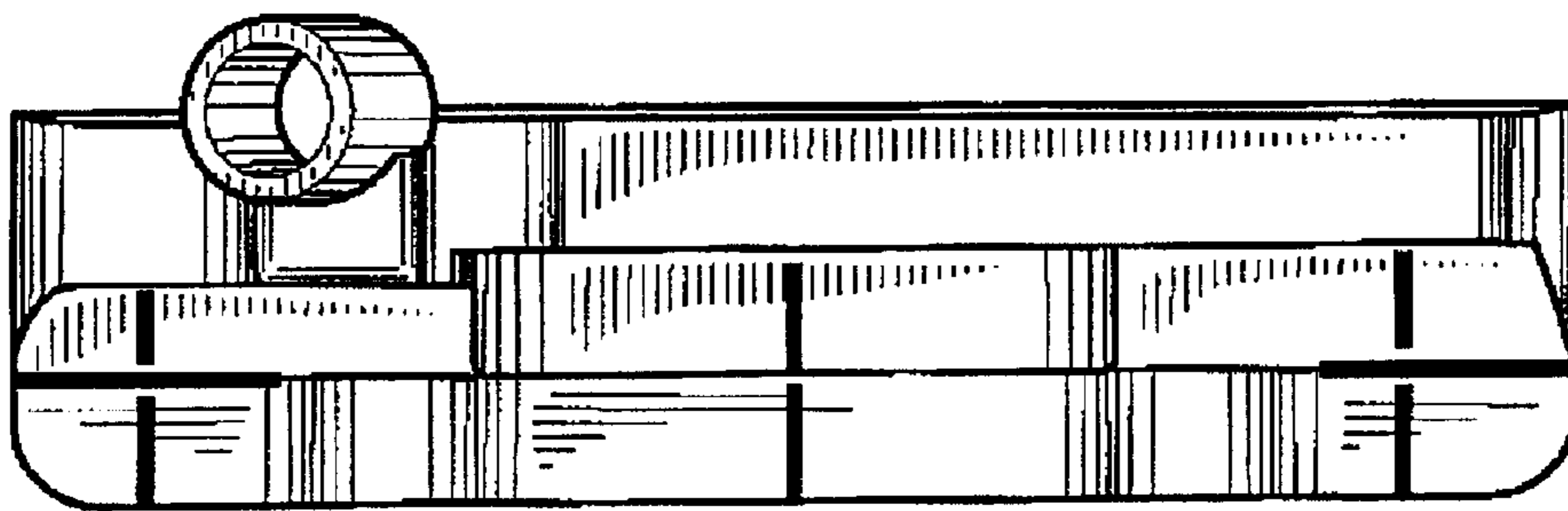


FIG. 4

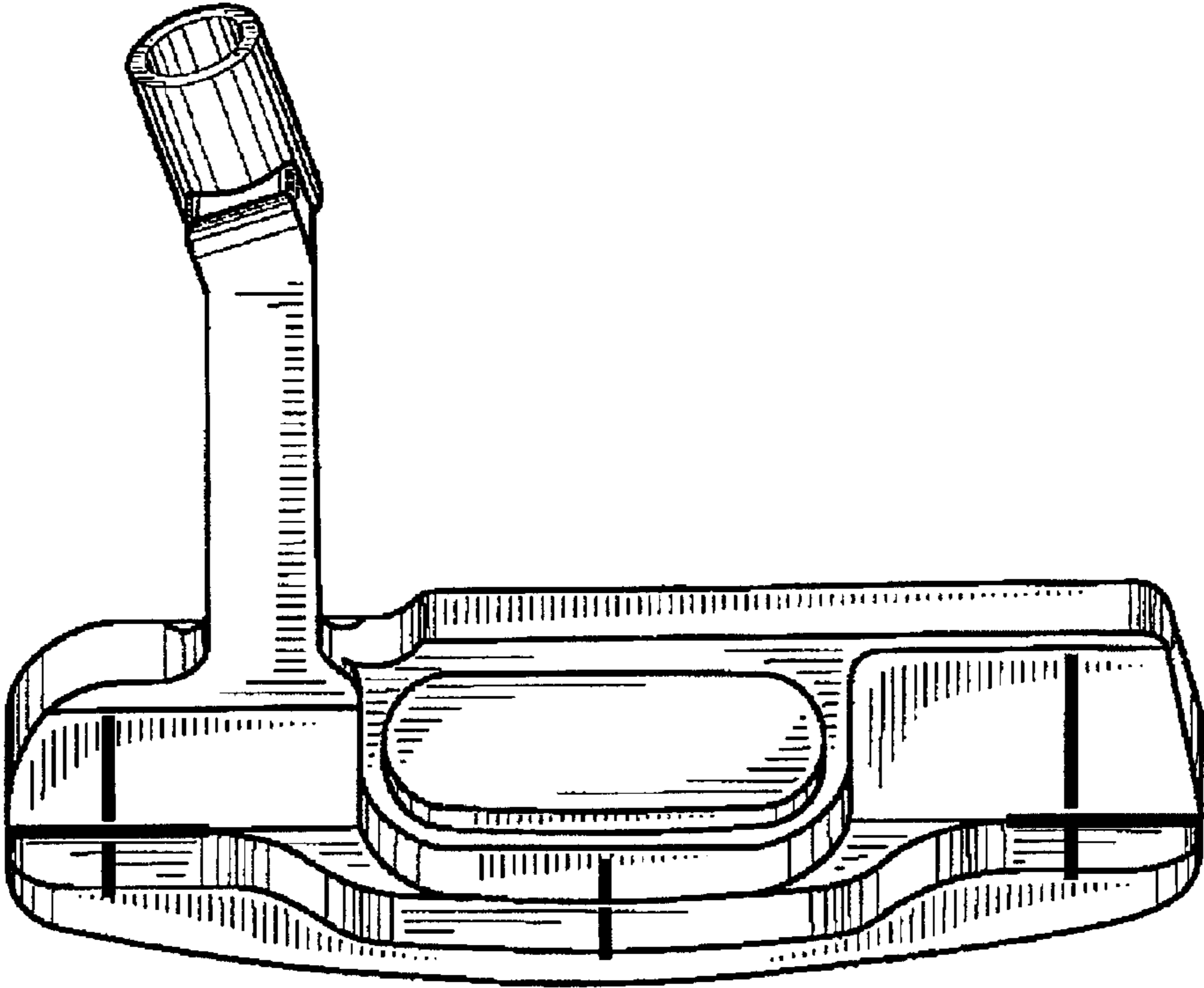
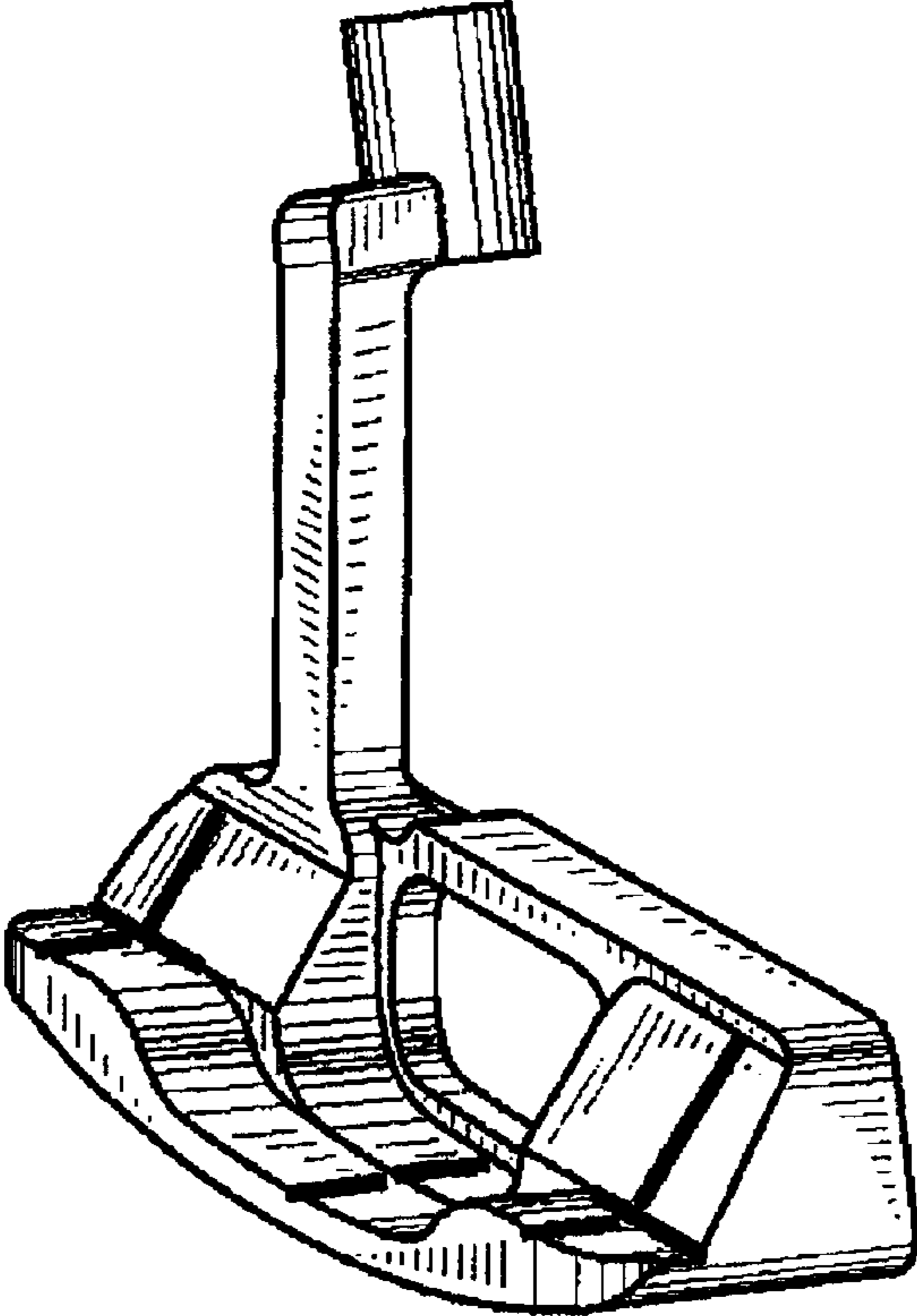
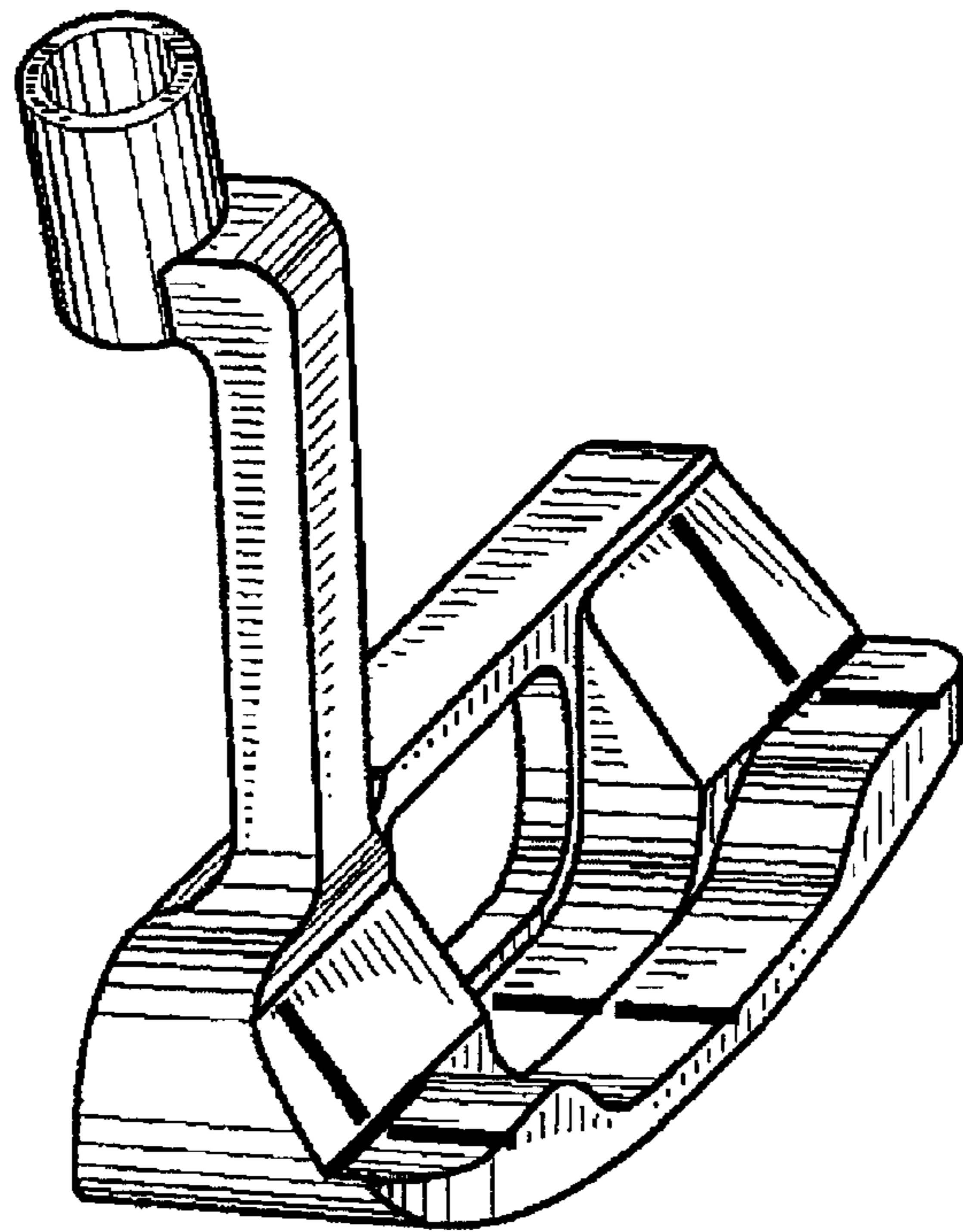


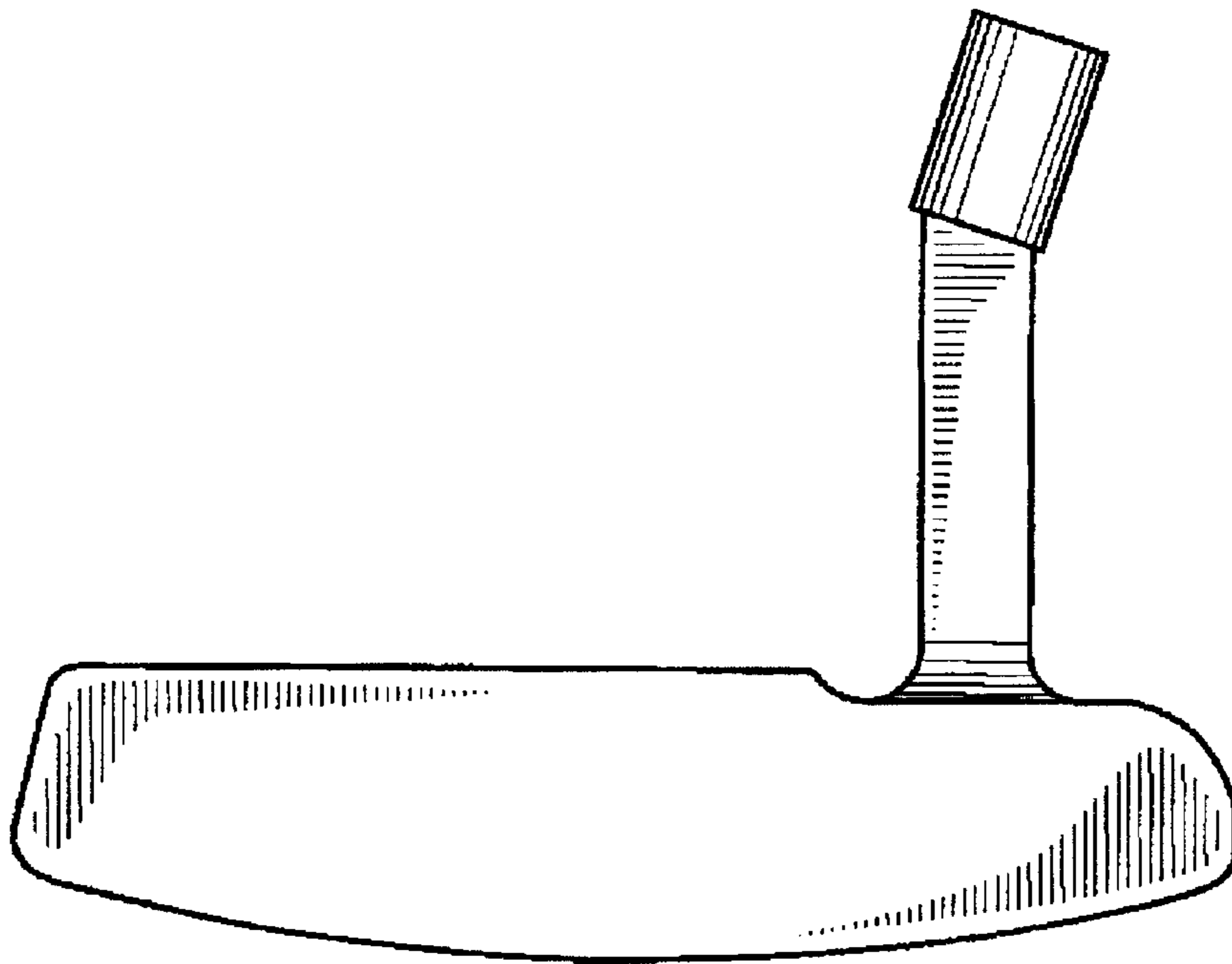
FIG. 5



**FIG. 6**

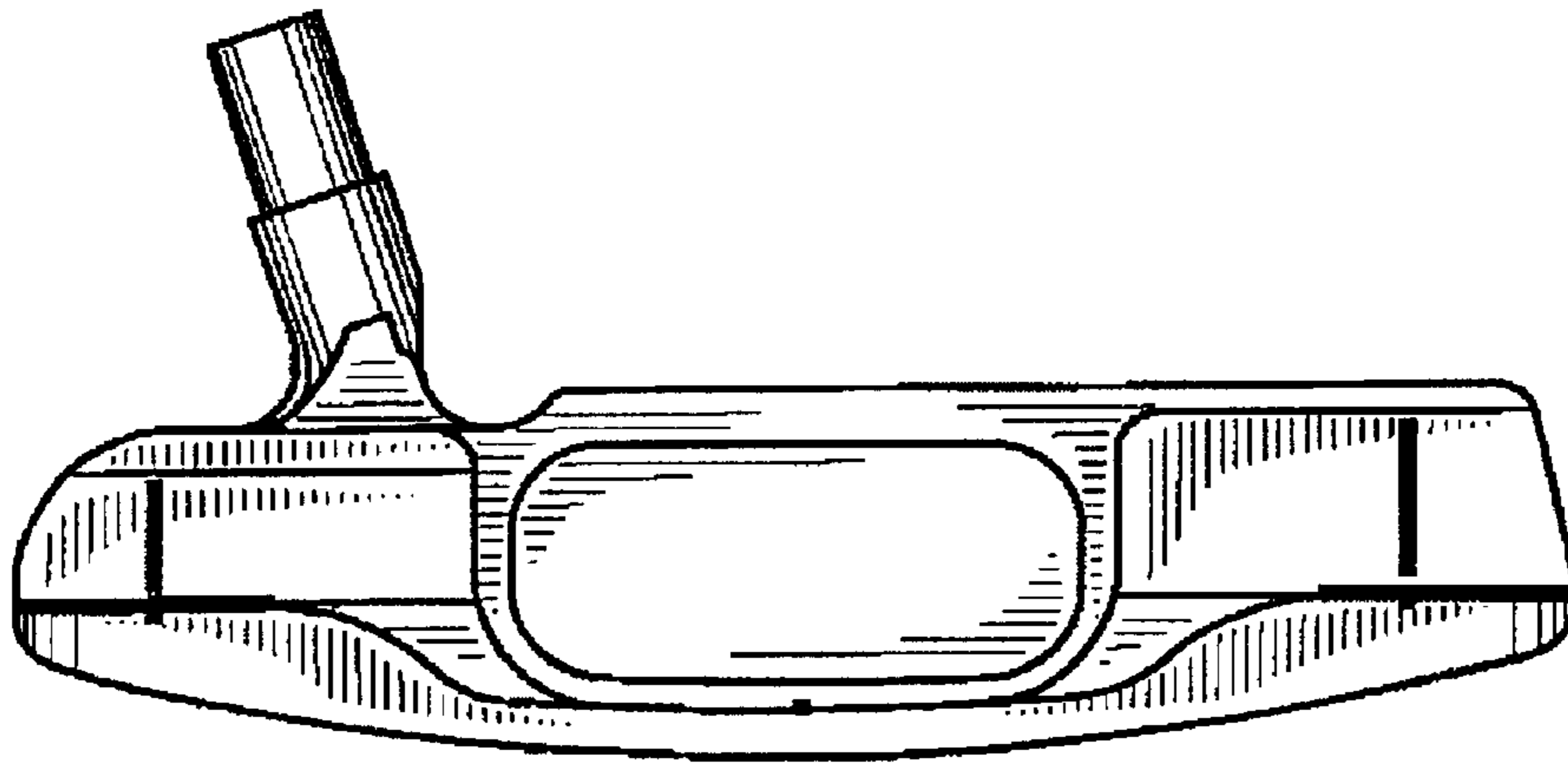


**FIG. 7**

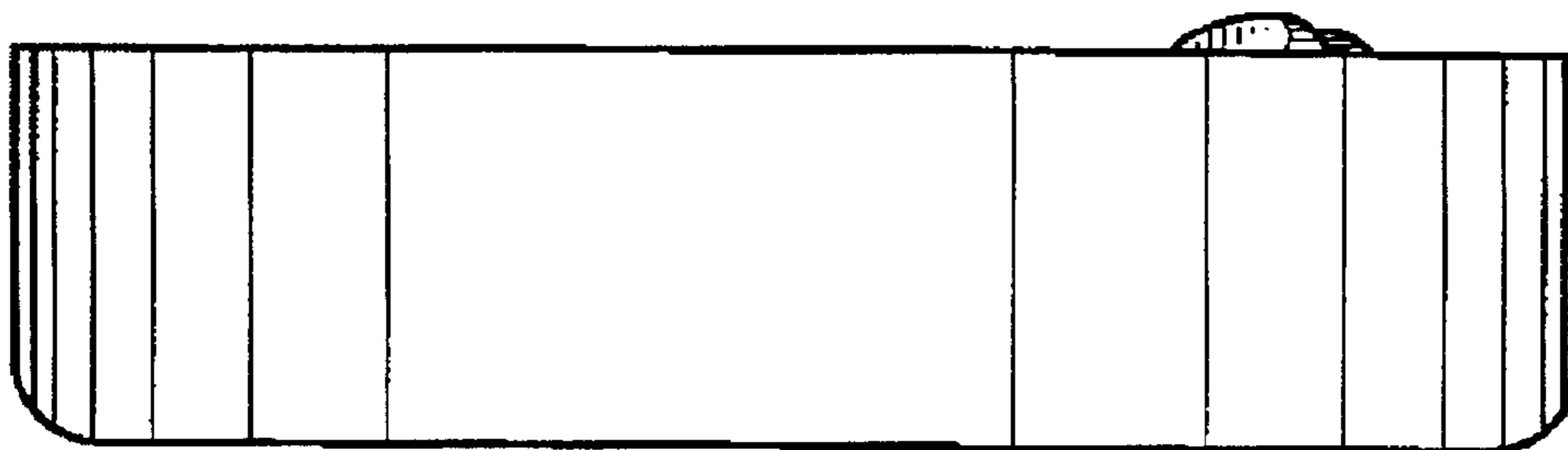




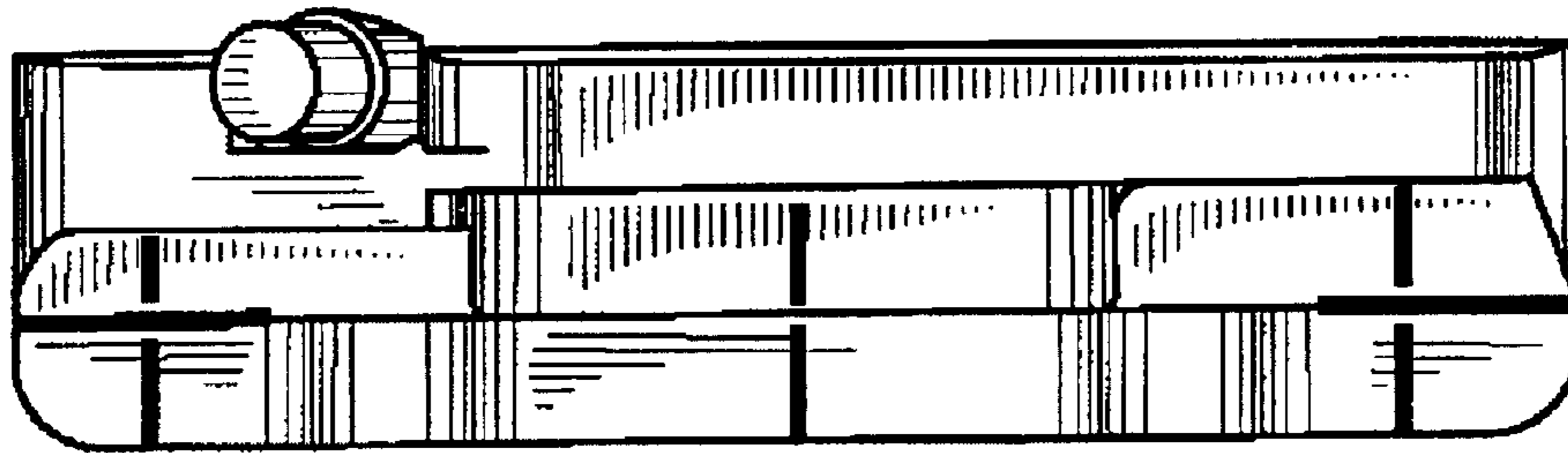
**FIG. 8**



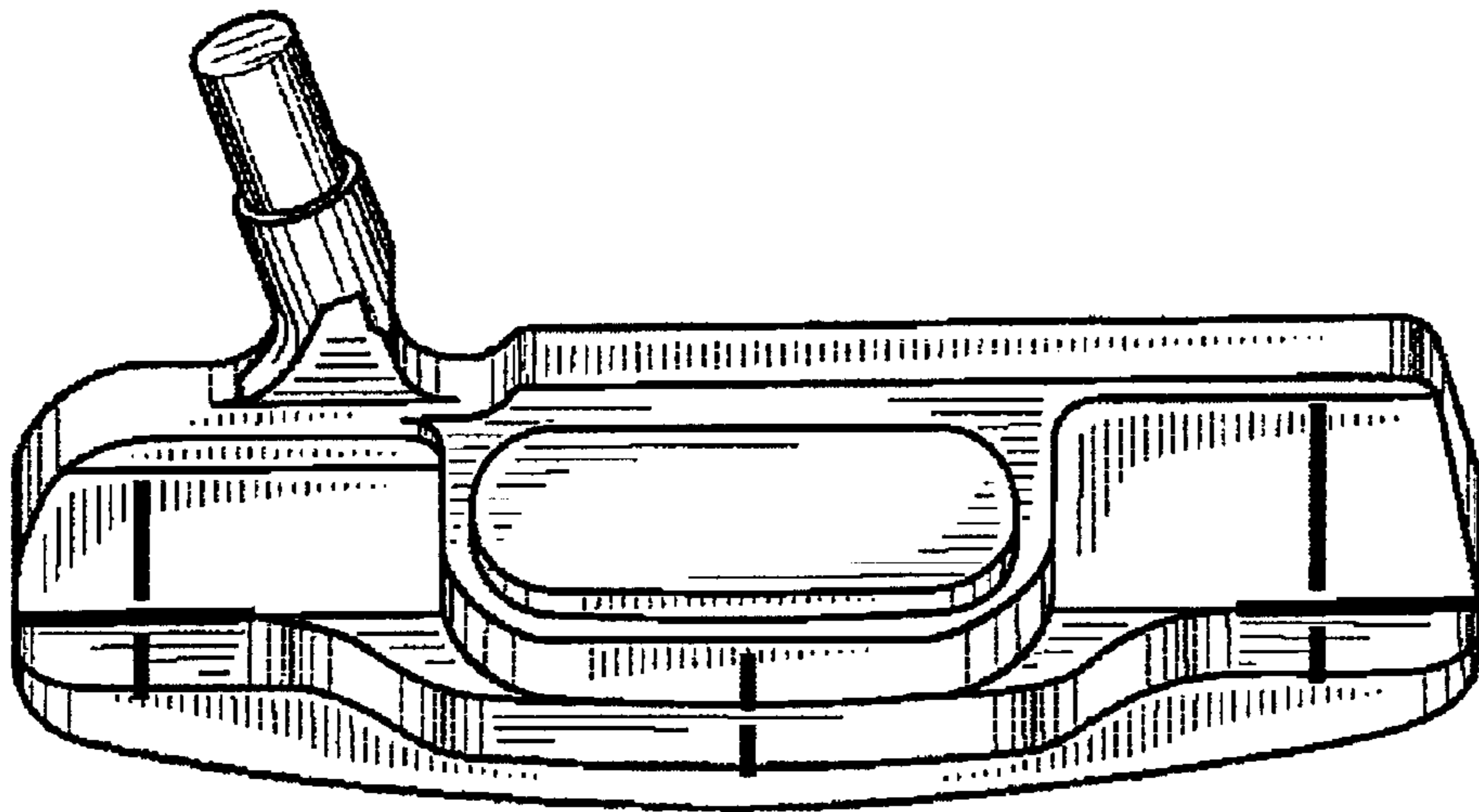
**FIG. 9**



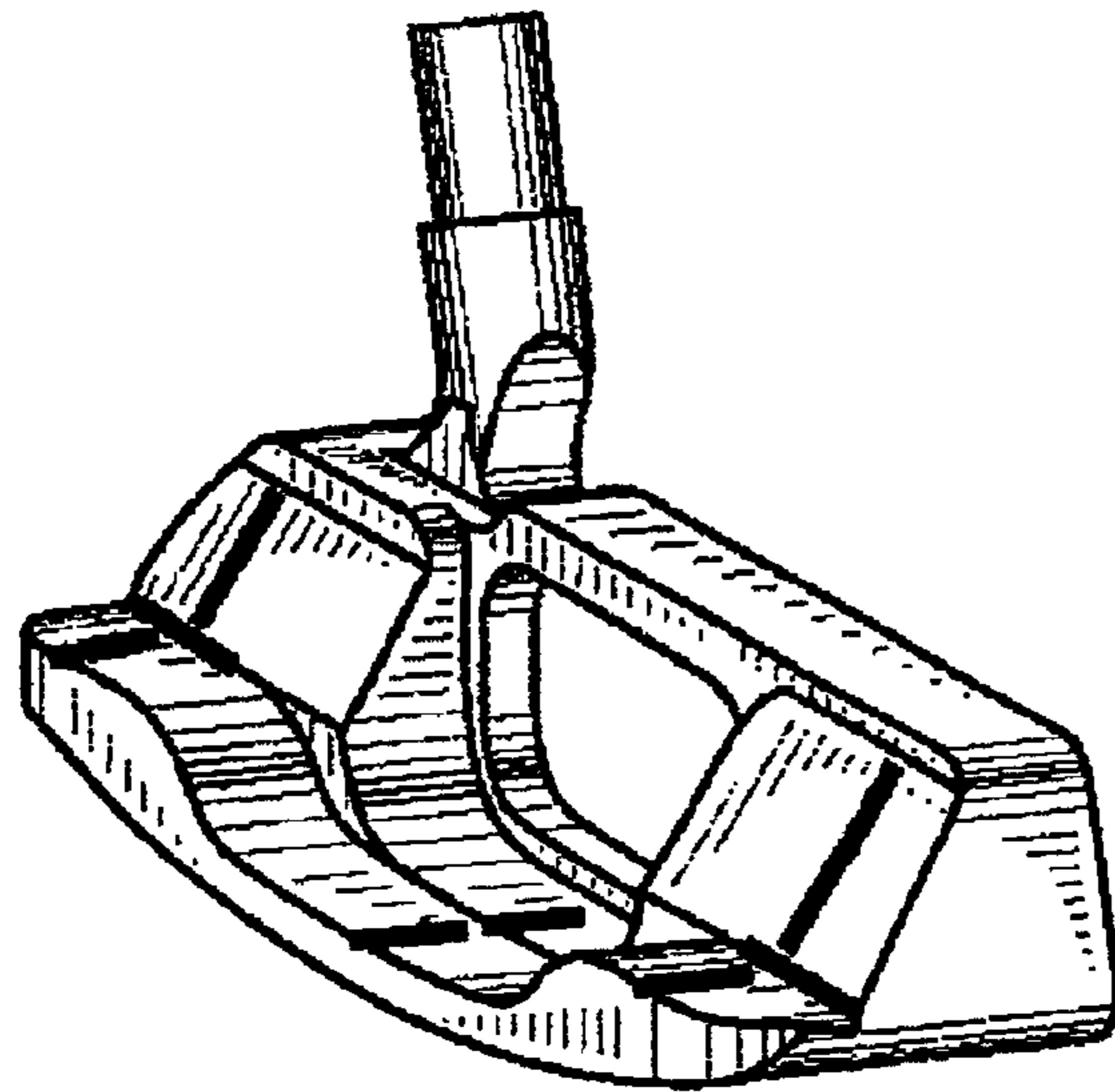
**FIG. 10**



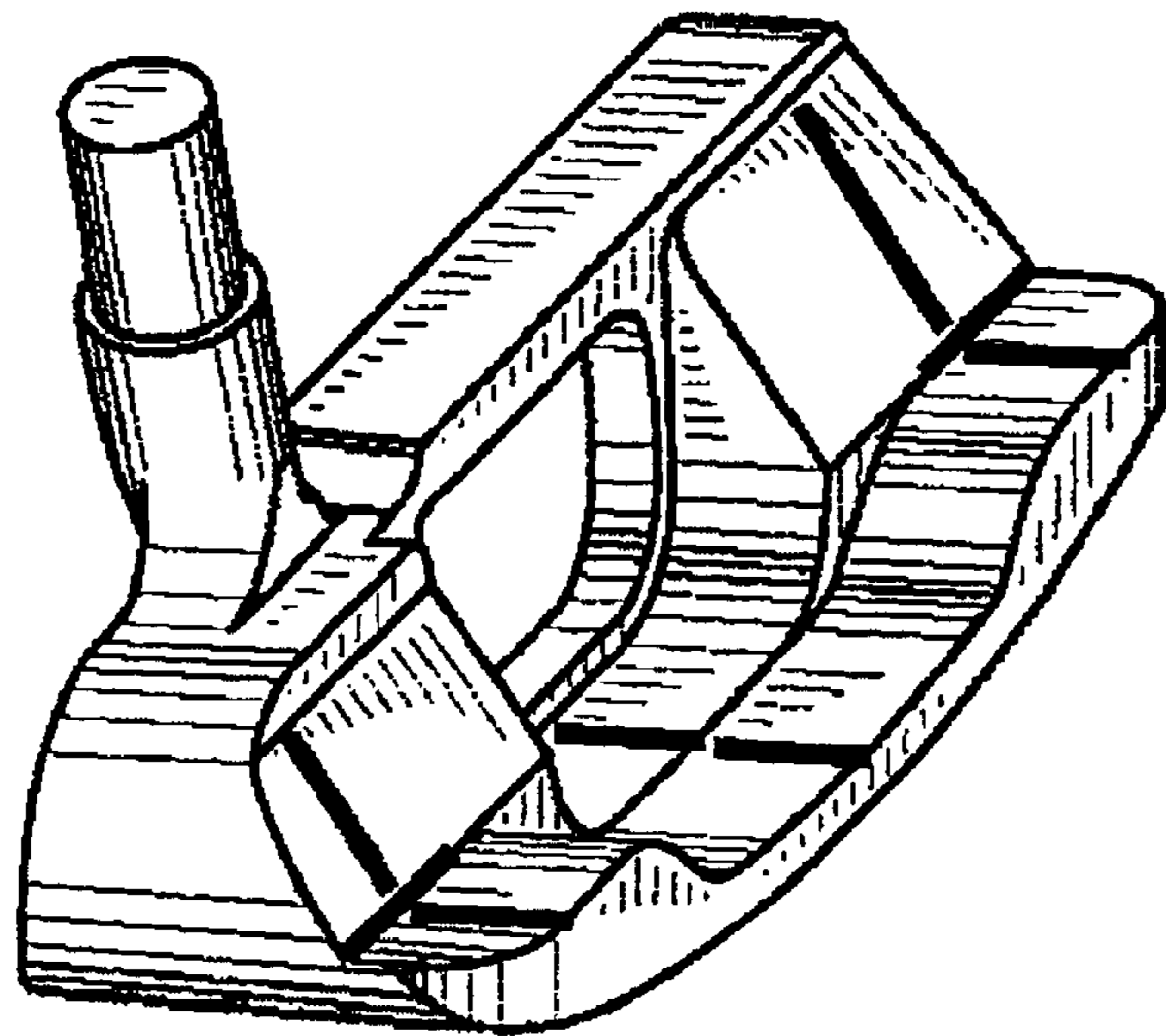
**FIG. 11**



**FIG. 12**



**FIG. 13**



**FIG. 14**

