

US00D535692S

(12) **United States Design Patent**
Gobbo

(10) **Patent No.:** **US D535,692 S**

(45) **Date of Patent:** **** Jan. 23, 2007**

(54) **PEN**

(75) **Inventor:** **Janko Gobbo, Jogodje-Izola (SI)**

(73) **Assignee:** **Sintesi Pen, Proizvodja in trgovina, d.o.o (SI)**

(**) **Term:** **14 Years**

(21) **Appl. No.:** **29/231,456**

(22) **Filed:** **Jun. 3, 2005**

(51) **LOC (8) Cl.** **19-06**

(52) **U.S. Cl.** **D19/49**

(58) **Field of Classification Search** D19/36,
D19/37, 41-51, 54-57; 24/11 R, 11 F, 11 P;
401/52, 99, 100, 104, 105, 106, 107, 108,
401/109, 192, 195, 243-247

See application file for complete search history.

(56) **References Cited**

U.S. PATENT DOCUMENTS

- D258,219 S * 2/1981 Oka D19/49
- D309,633 S * 7/1990 Itoh D19/51
- D339,822 S * 9/1993 Mock et al. D19/48
- D444,500 S * 7/2001 Izushima D19/51

D469,467 S * 1/2003 Briggel D19/51

D471,590 S * 3/2003 Lecce D19/51

D477,027 S * 7/2003 Bain D19/56

D497,642 S 10/2004 Lovell

D501,030 S * 1/2005 Lecce D19/51

D507,019 S 7/2005 Lovell

D511,545 S * 11/2005 Chiaruttini D19/51

* cited by examiner

Primary Examiner—Elizabeth A. Albert

(74) *Attorney, Agent, or Firm*—Jackson Walker, L.L.P.;
William B. Nash; Mark H. Miller

(57) **CLAIM**

The ornamental design for a pen, as shown and described.

DESCRIPTION

FIG. 1 is a perspective view of the pen showing my new design;

FIG. 2 is a front view thereof.

FIG. 3 is a bottom view thereof.

FIG. 4 is a rear view thereof.

FIG. 5 is a side view thereof; and,

FIG. 6 is a top view thereof.

1 Claim, 2 Drawing Sheets

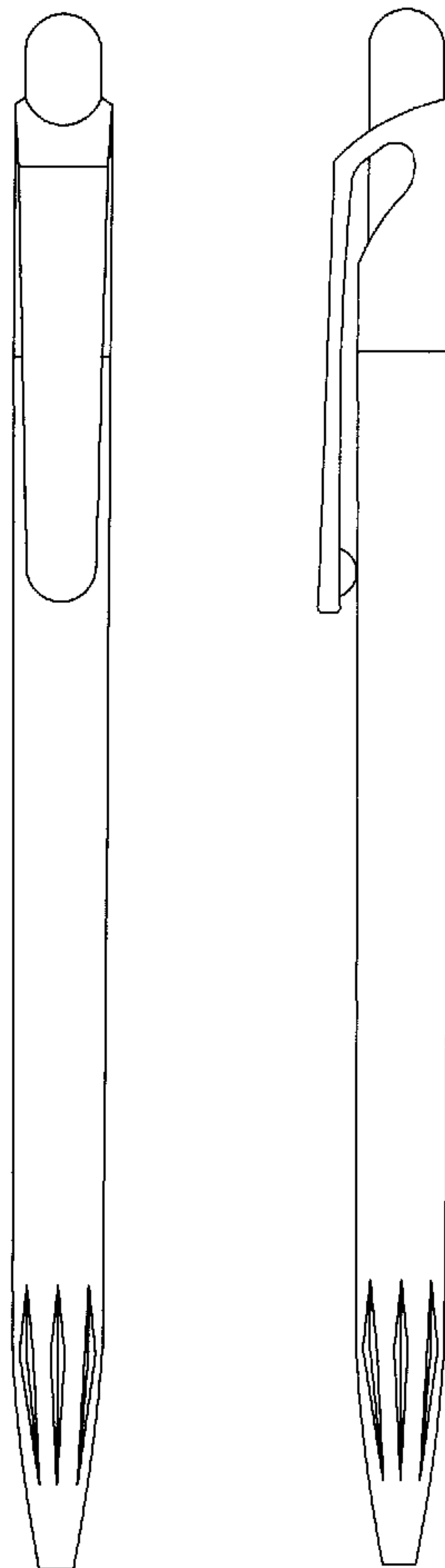

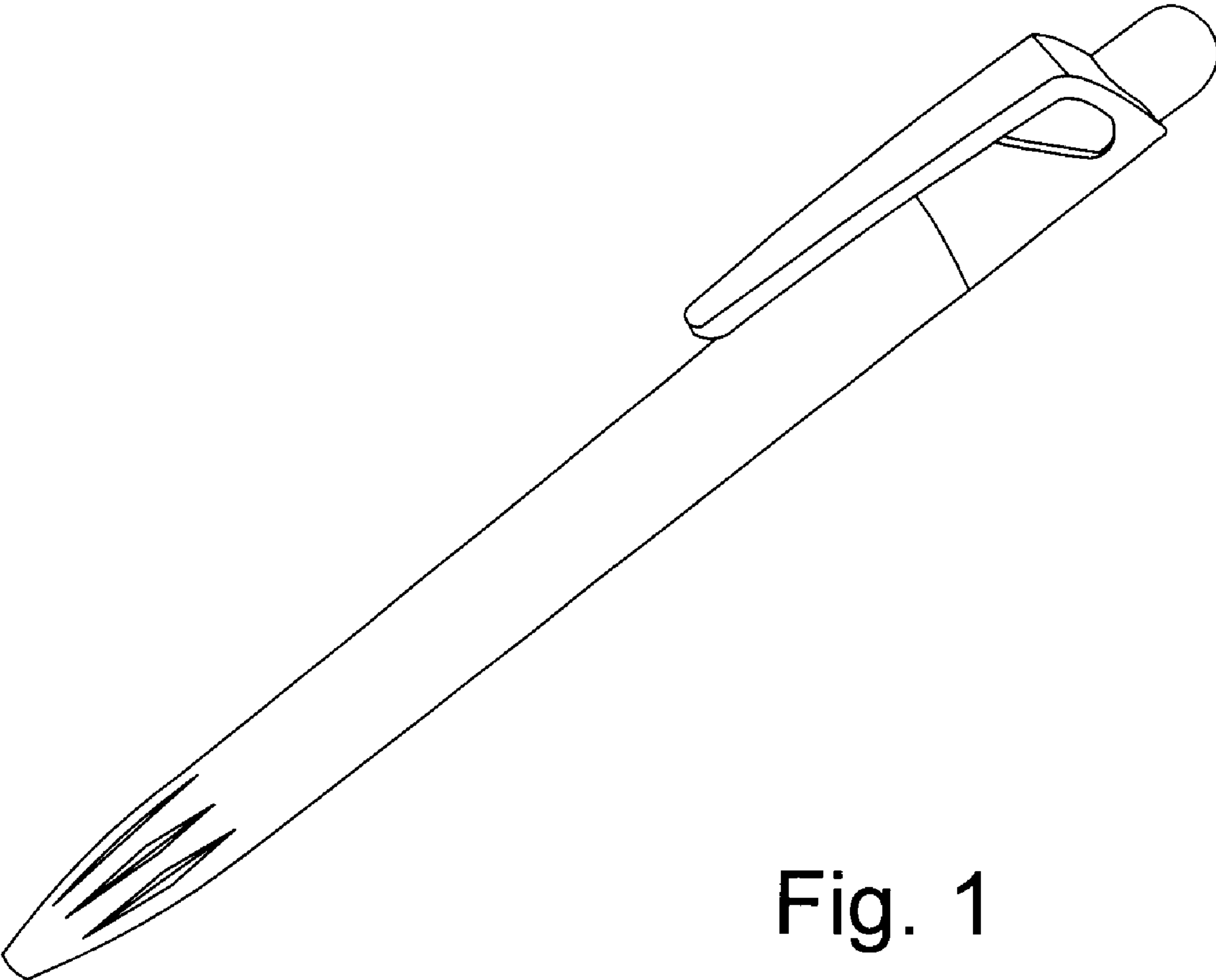

Fig. 1

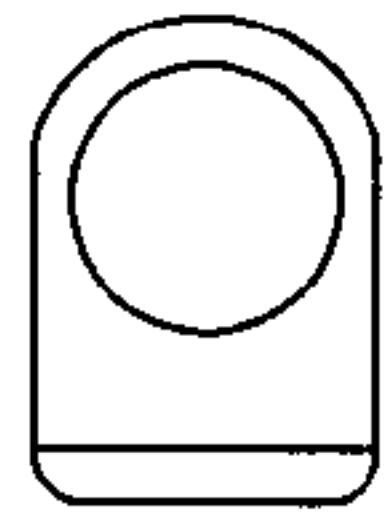

Fig. 6

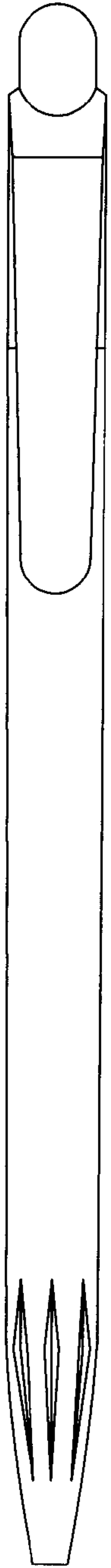

Fig. 2

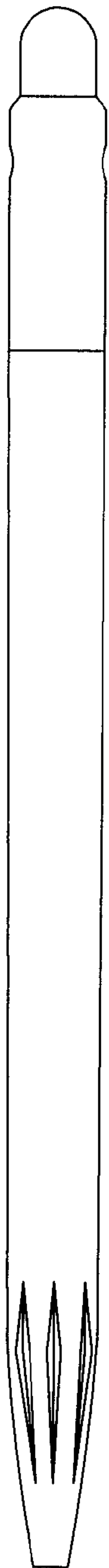

Fig. 4

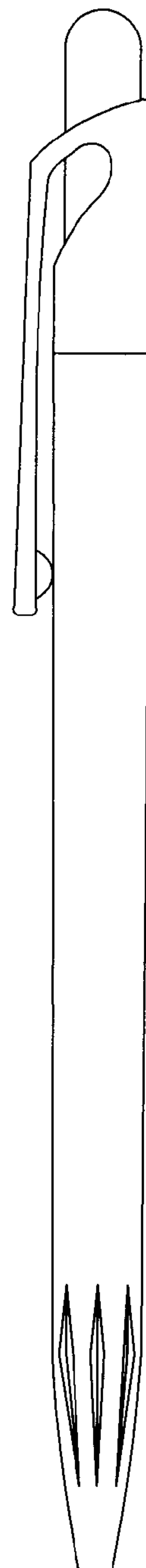

Fig. 5

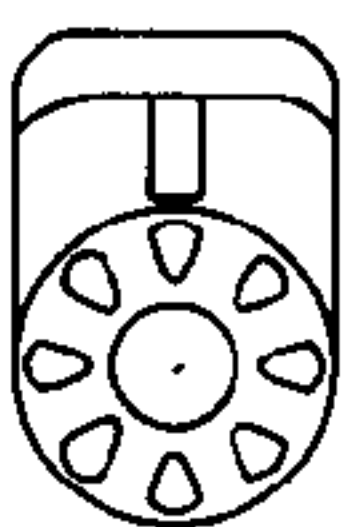

Fig. 3