



US00D535691S

(12) **United States Design Patent**
Robertson

(10) **Patent No.:** **US D535,691 S**

(45) **Date of Patent:** **** Jan. 23, 2007**

(54) **PHOTOGRAPH PROOF AND PHOTO
COMPACT DISC INDEX CARD**

2001/0032793 A1 * 10/2001 Bergh et al. 206/308.1
2002/0197098 A1 * 12/2002 Palmer 206/308.1

(75) Inventor: **Judith M. Robertson**, Hercules, CA
(US)

* cited by examiner

Primary Examiner—Robert A. Delehanty

Assistant Examiner—Mark Cavanna

(73) Assignee: **Elsa L, Inc.**, San Rafael, CA (US)

(74) *Attorney, Agent, or Firm*—Charles H. Jew

(**) Term: **14 Years**

(57) **CLAIM**

(21) Appl. No.: **29/257,106**

The ornamental design for a photograph proof and photo compact disc index card, as shown and described.

(22) Filed: **Mar. 29, 2006**

DESCRIPTION

(51) **LOC (8) Cl.** **19-01**

(52) **U.S. Cl.** **D19/1**

(58) **Field of Classification Search** D19/1-8;
D6/626; 206/307, 308.1, 455, 473; 229/67.1,
229/72

See application file for complete search history.

FIG. 1 is a front elevational view of the photograph proof and photo compact disc index card with an open window showing my design;

FIG. 2 is a rear elevational view thereof;

FIG. 3 is a front perspective view thereof;

FIG. 4 is a rear perspective view thereof;

FIG. 5 is an enlarged left side elevational view thereof;

FIG. 6 is an enlarged right side elevation view thereof;

FIG. 7 is an enlarged top plan view thereof; and,

FIG. 8 is an enlarged bottom plan view thereof.

The broken lines showing a photographic proof sheet and compact disc are for illustrative purposes and form no part of the claimed design.

(56) **References Cited**

U.S. PATENT DOCUMENTS

3,979,051 A * 9/1976 Close 229/72
4,057,140 A * 11/1977 Hutzl 206/455
4,149,667 A * 4/1979 Riley 229/72
5,431,449 A * 7/1995 Arimoto et al. 206/473
D363,083 S * 10/1995 Thompson et al. D19/3
6,270,932 B1 * 8/2001 Tatsumi et al. 430/11

1 Claim, 4 Drawing Sheets

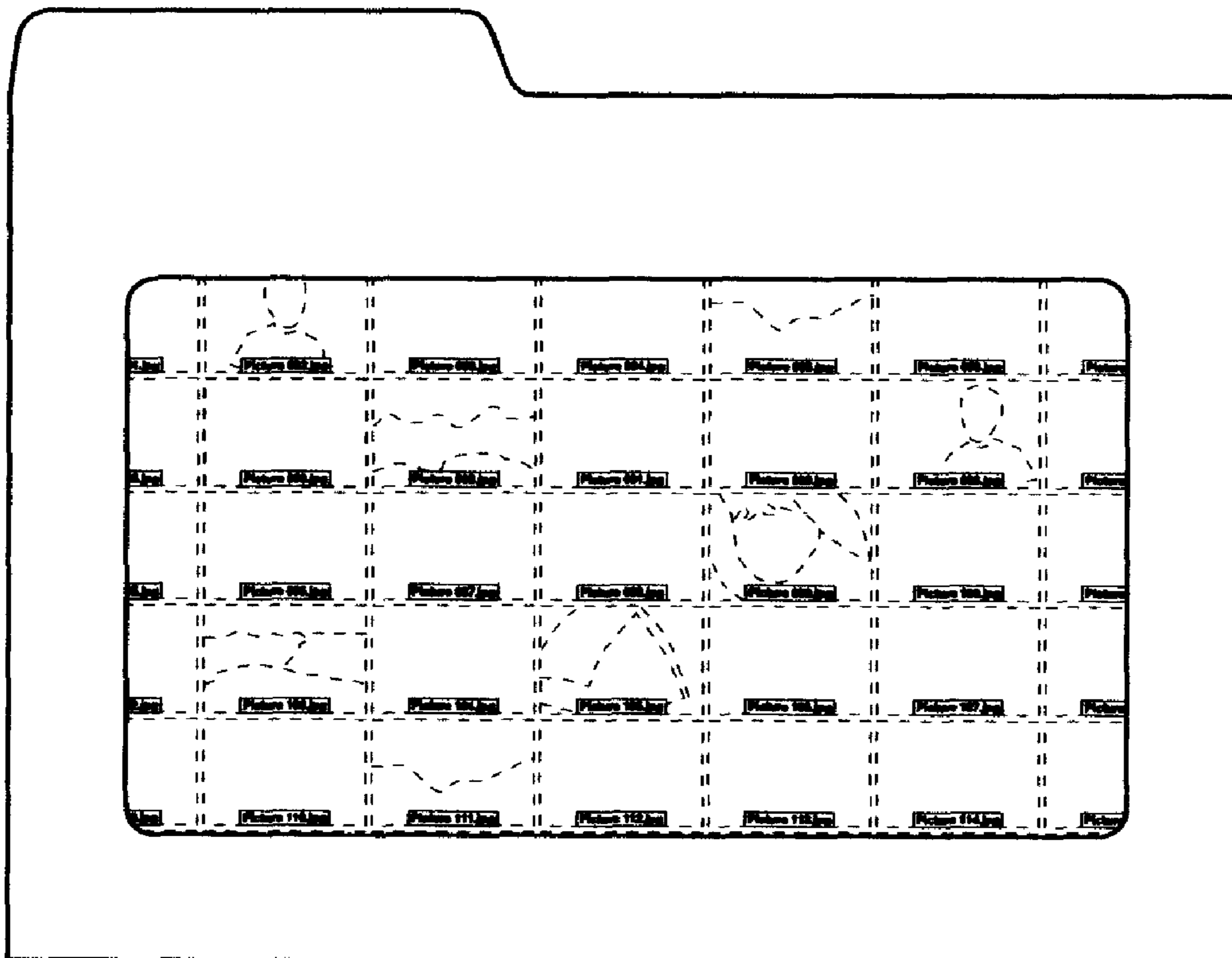

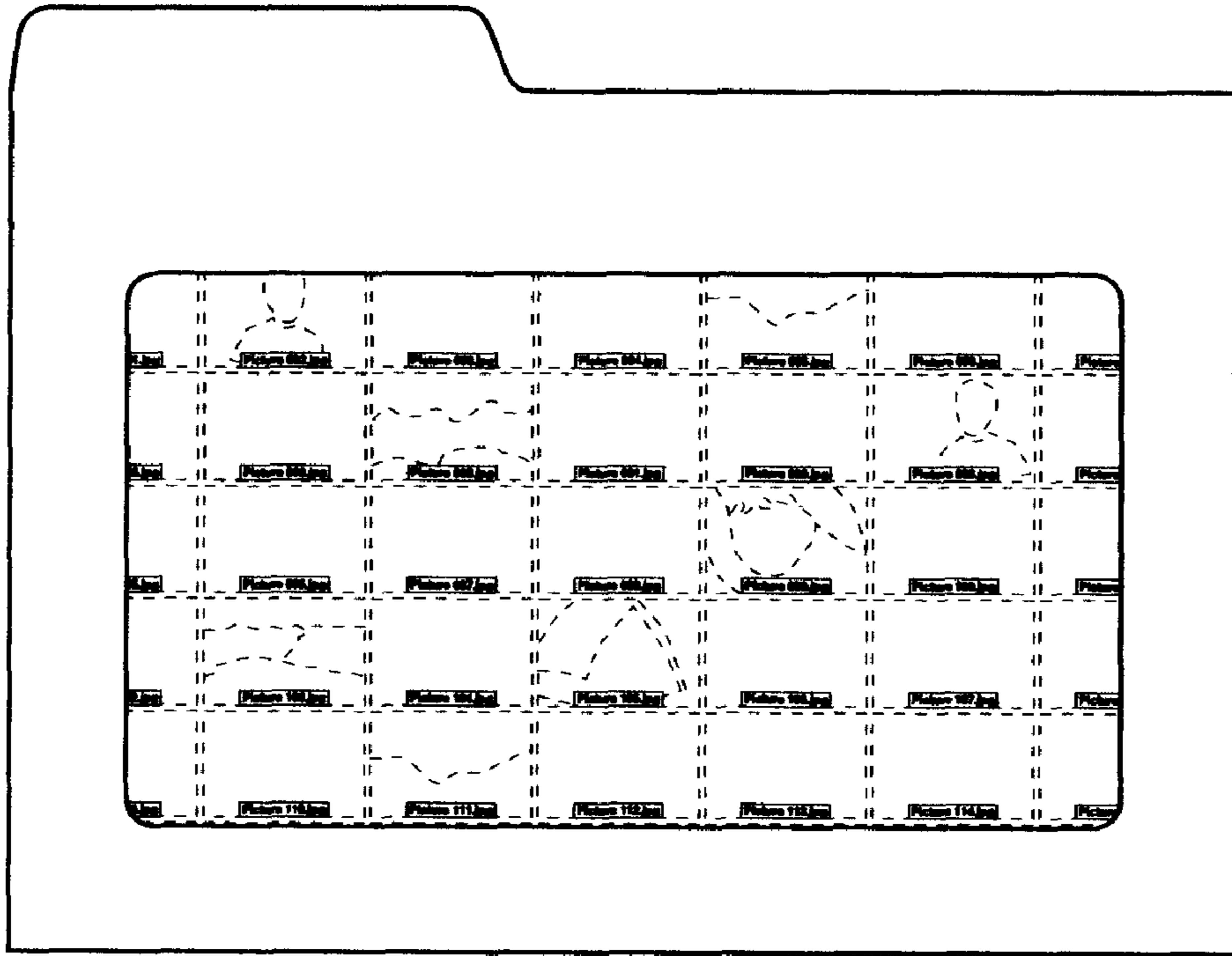

FIG. 1

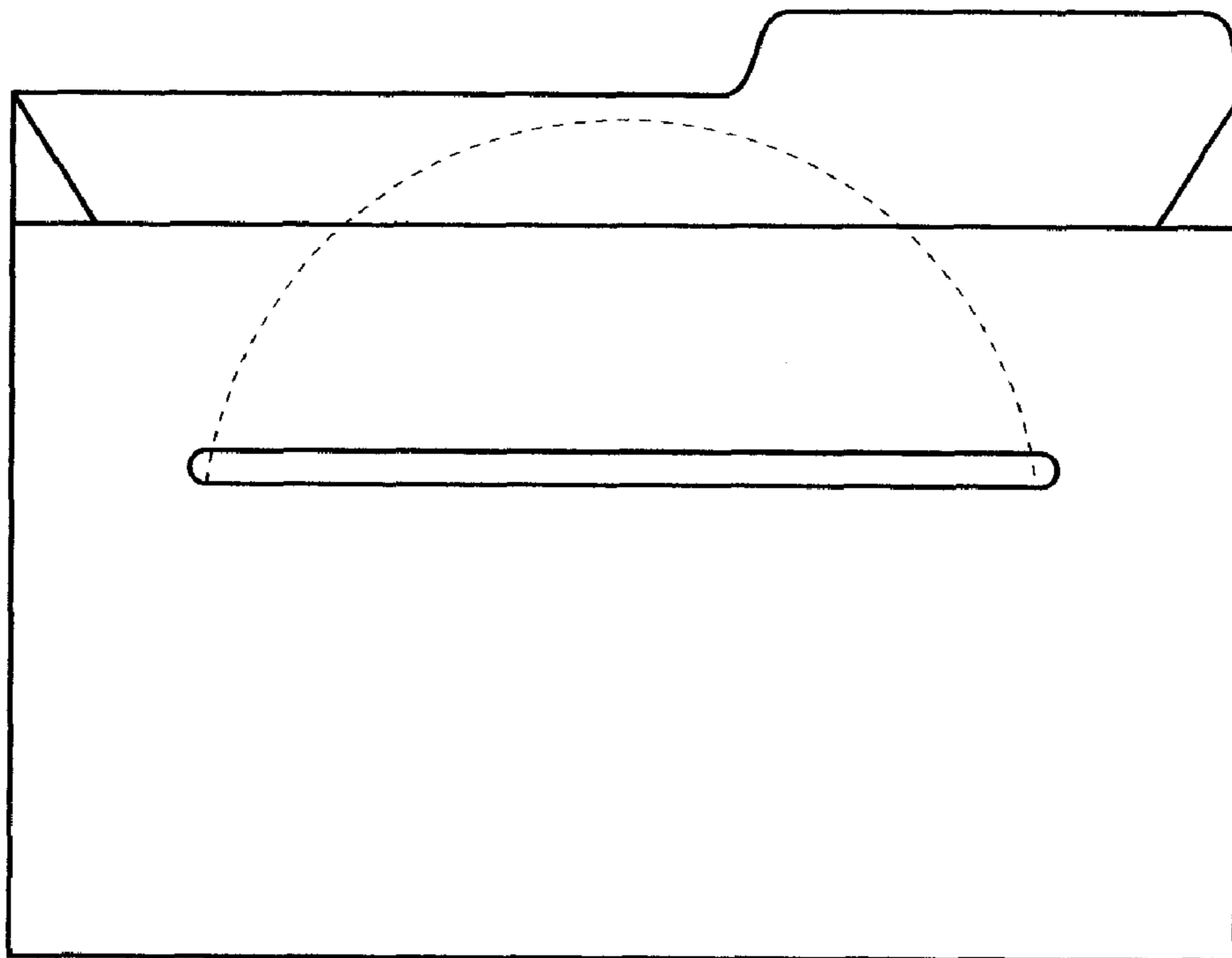

FIG. 2

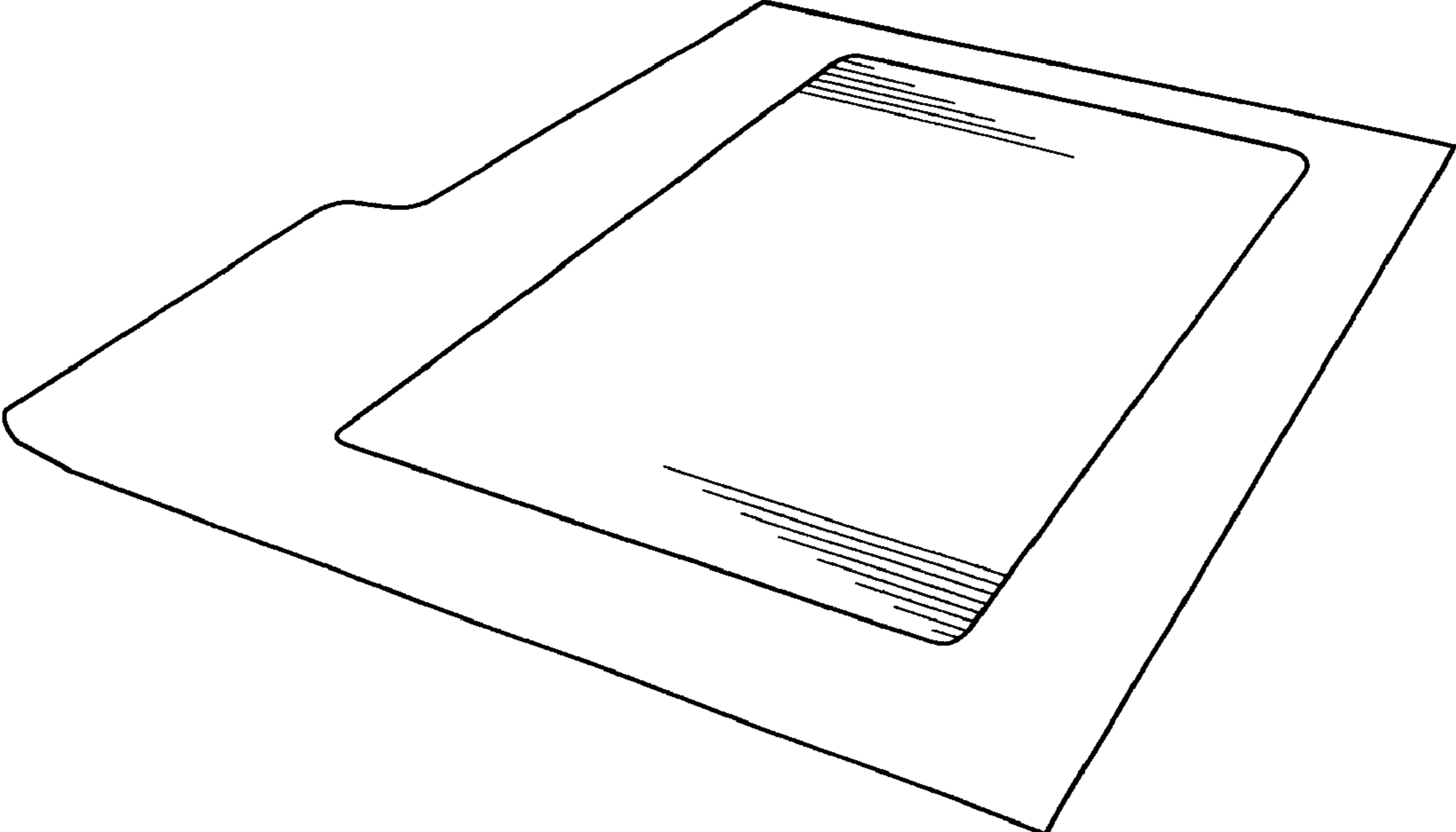

FIG. 3

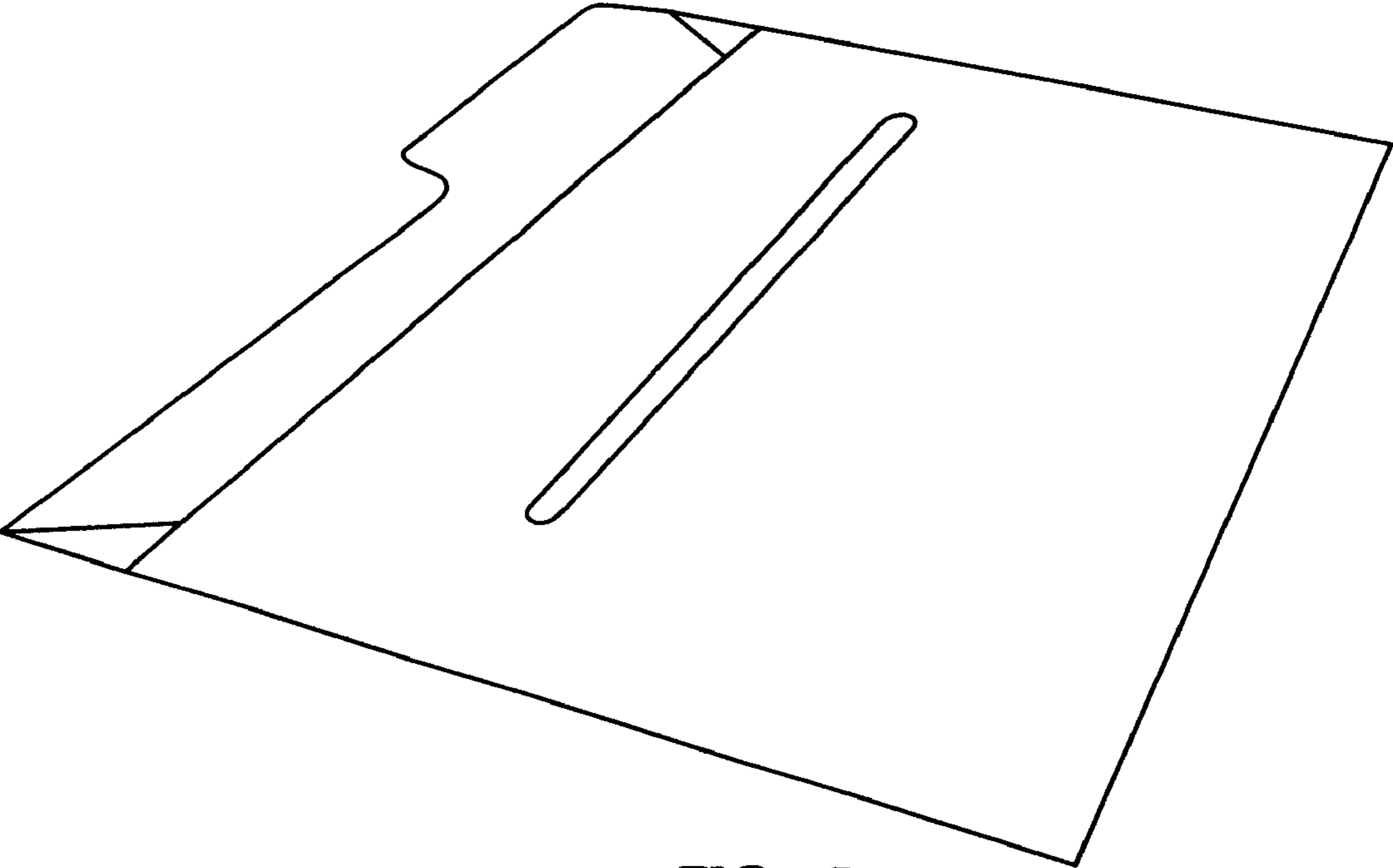

FIG. 4



FIG. 5



FIG. 6

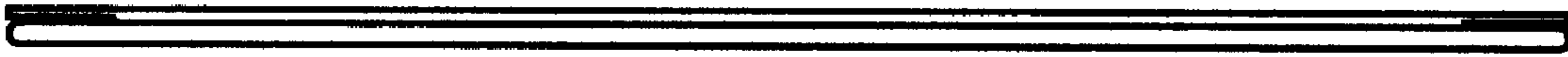

FIG. 7

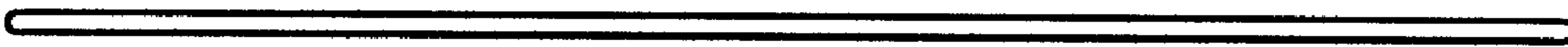

FIG. 8