



US00D535649S

(12) **United States Design Patent**
Loiske

(10) **Patent No.:** **US D535,649 S**

(45) **Date of Patent:** **** Jan. 23, 2007**

(54) **HANDSFREE DEVICE FOR A HANDSET**

(75) Inventor: **Janne Loiske**, Turku (FI)

(73) Assignee: **Nokia Corporation**, Espoo (FI)

(**) Term: **14 Years**

(21) Appl. No.: **29/212,851**

(22) Filed: **Sep. 9, 2004**

(30) **Foreign Application Priority Data**

Mar. 12, 2004 (FI) M20040041

(51) **LOC (8) Cl.** **14-03**

(52) **U.S. Cl.** **D14/240**

(58) **Field of Classification Search** D14/240,
D14/242, 206, 192, 223; D13/184; 181/129-130;
379/430, 431, 433.01, 420.03, 52; 455/569.1
See application file for complete search history.

(56) **References Cited**

U.S. PATENT DOCUMENTS

D236,838 S	*	9/1975	Valente	D14/192
5,793,865 A	*	8/1998	Leifer	379/430
D409,621 S	*	5/1999	Andrea	D14/223
D420,669 S	*	2/2000	Lindahl	D14/227
6,038,312 A	*	3/2000	Bromley	379/430
6,101,402 A	*	8/2000	Bartha et al.	455/569.1
D460,960 S	*	7/2002	Kao	D14/223
D464,943 S	*	10/2002	Lai	D14/206

D470,835 S	*	2/2003	Bey et al.	D14/223
D472,231 S	*	3/2003	Eisenbraun	D14/223
D478,579 S		8/2003	Sade		
D490,399 S	*	5/2004	Kamo et al.	D14/206
D497,357 S	*	10/2004	Allum et al.	D14/206
D503,705 S	*	4/2005	Boursiquot	D14/223
D504,887 S	*	5/2005	Skulley	D14/223
D512,992 S	*	12/2005	Murakami	D14/223
D515,697 S	*	2/2006	Nakamura et al.	D24/110

* cited by examiner

Primary Examiner—Charles A. Rademaker

(74) *Attorney, Agent, or Firm*—Banner & Witcoff, Ltd.

(57) **CLAIM**

The ornamental design for a handsfree device for a handset, as shown and described.

DESCRIPTION

FIG. 1 is a perspective front view of a handsfree device for a handset showing my new design;
FIG. 2 is a perspective review thereof;
FIG. 3 is a front view thereof;
FIG. 4 is a rear view thereof;
FIG. 5 is a bottom plan view thereof;
FIG. 6 is a top plan view thereof;
FIG. 7 is a perspective front view of the handsfree device of FIGS. 1-6 in an alternative in-use position; and,
FIG. 8 is a rear perspective view thereof.

1 Claim, 6 Drawing Sheets

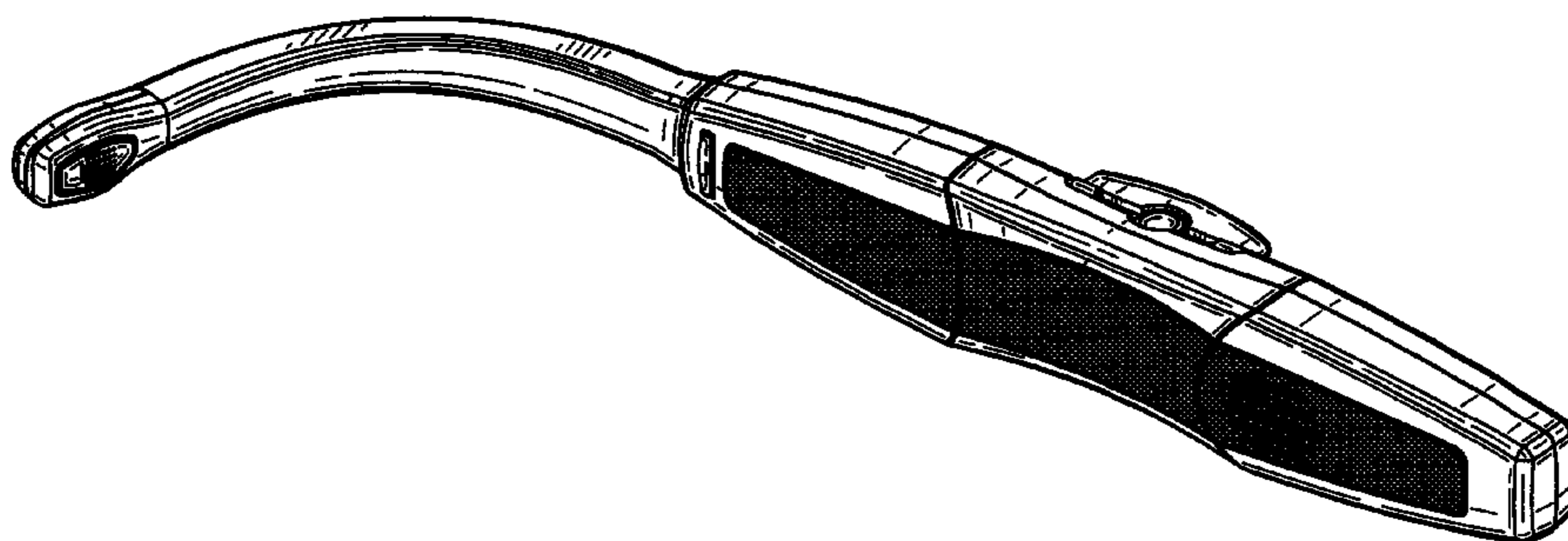
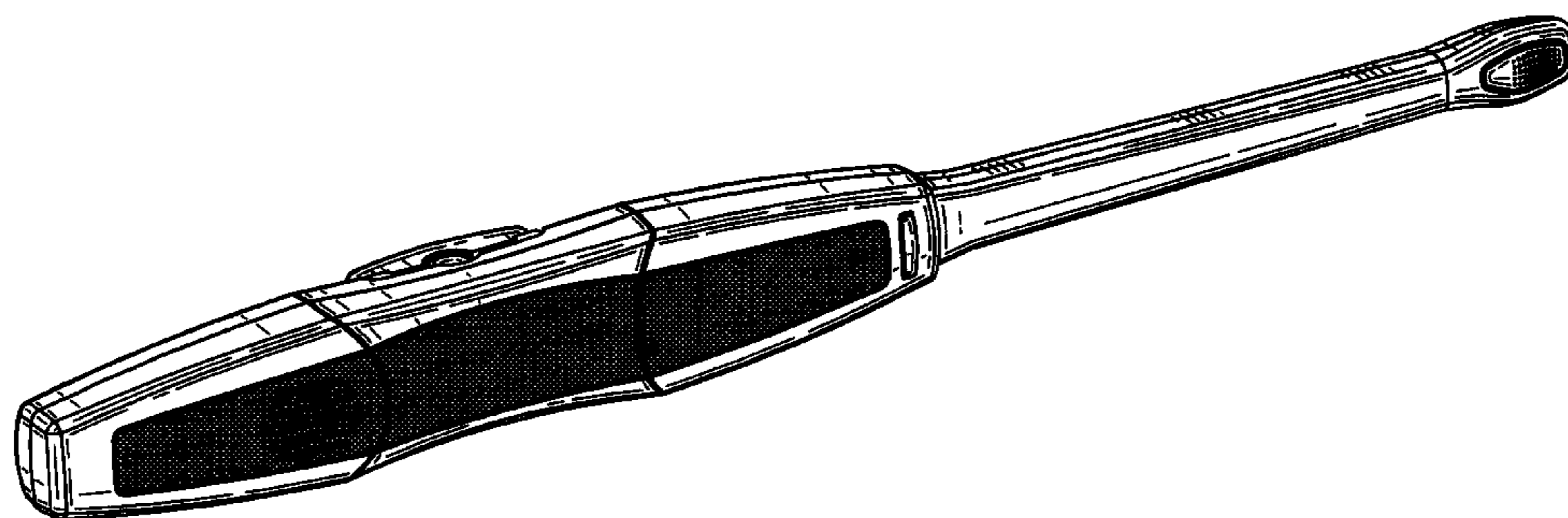

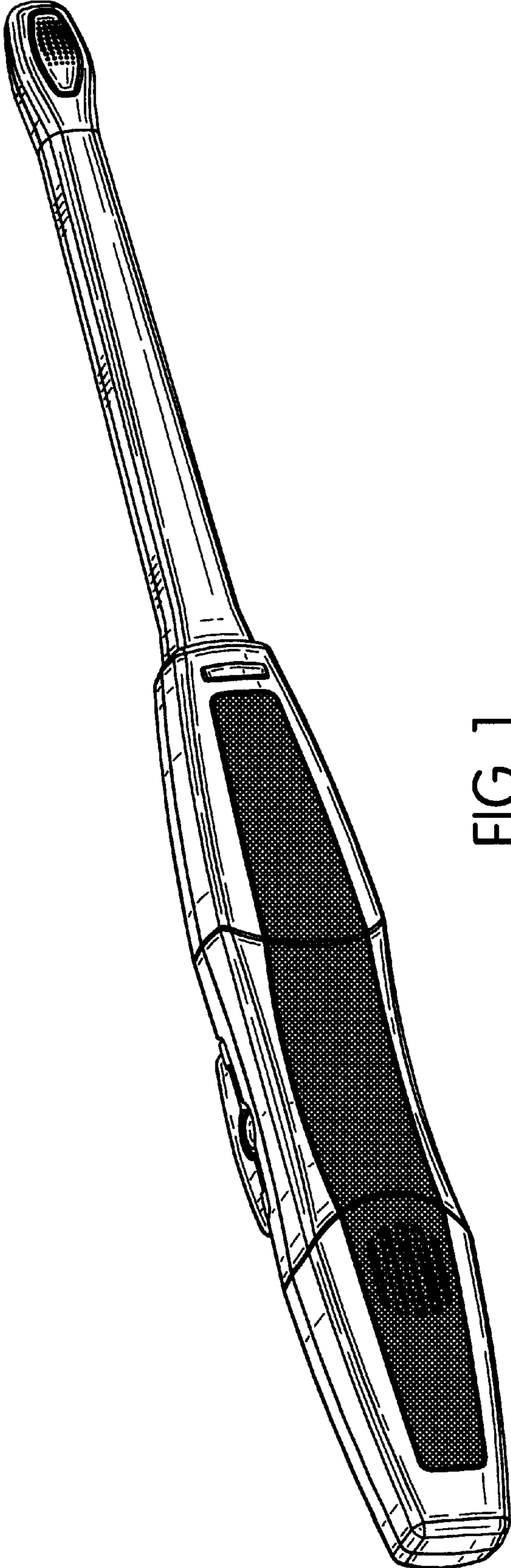

FIG. 1

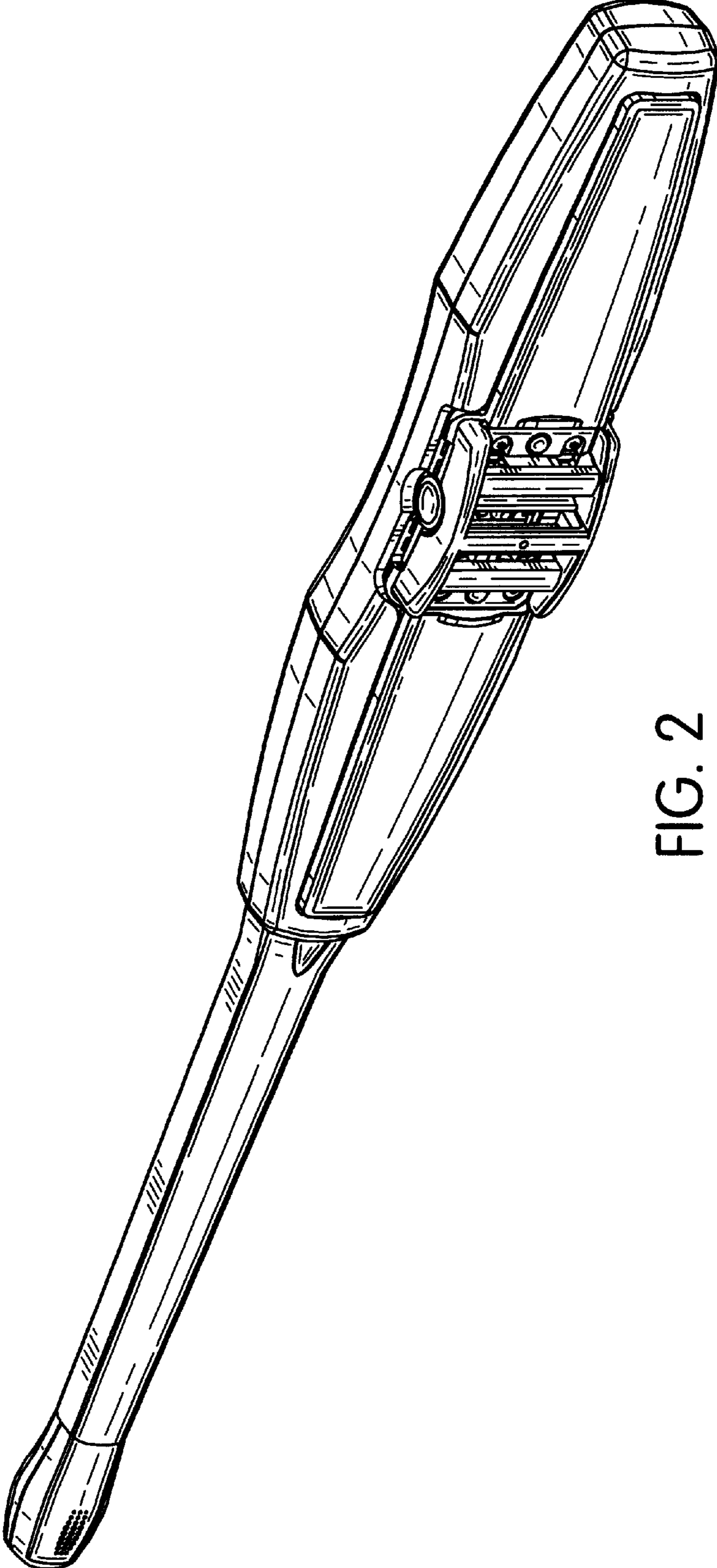

FIG. 2

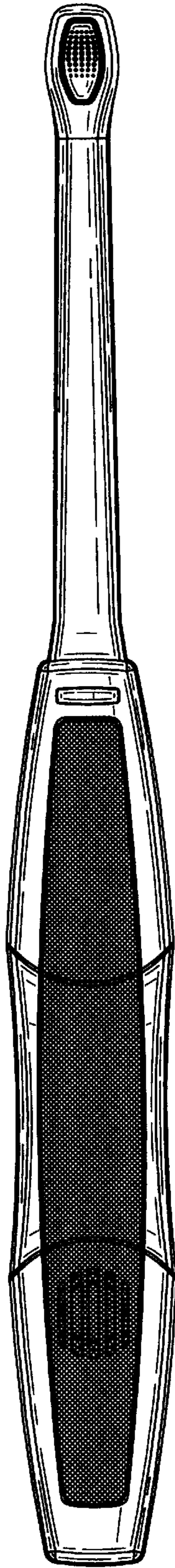

FIG. 3

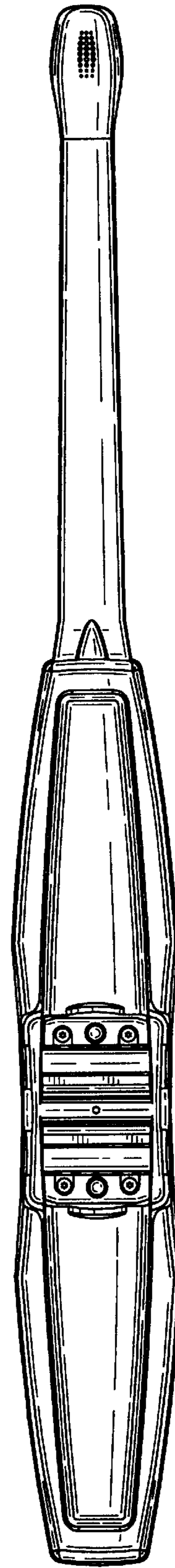

FIG. 4

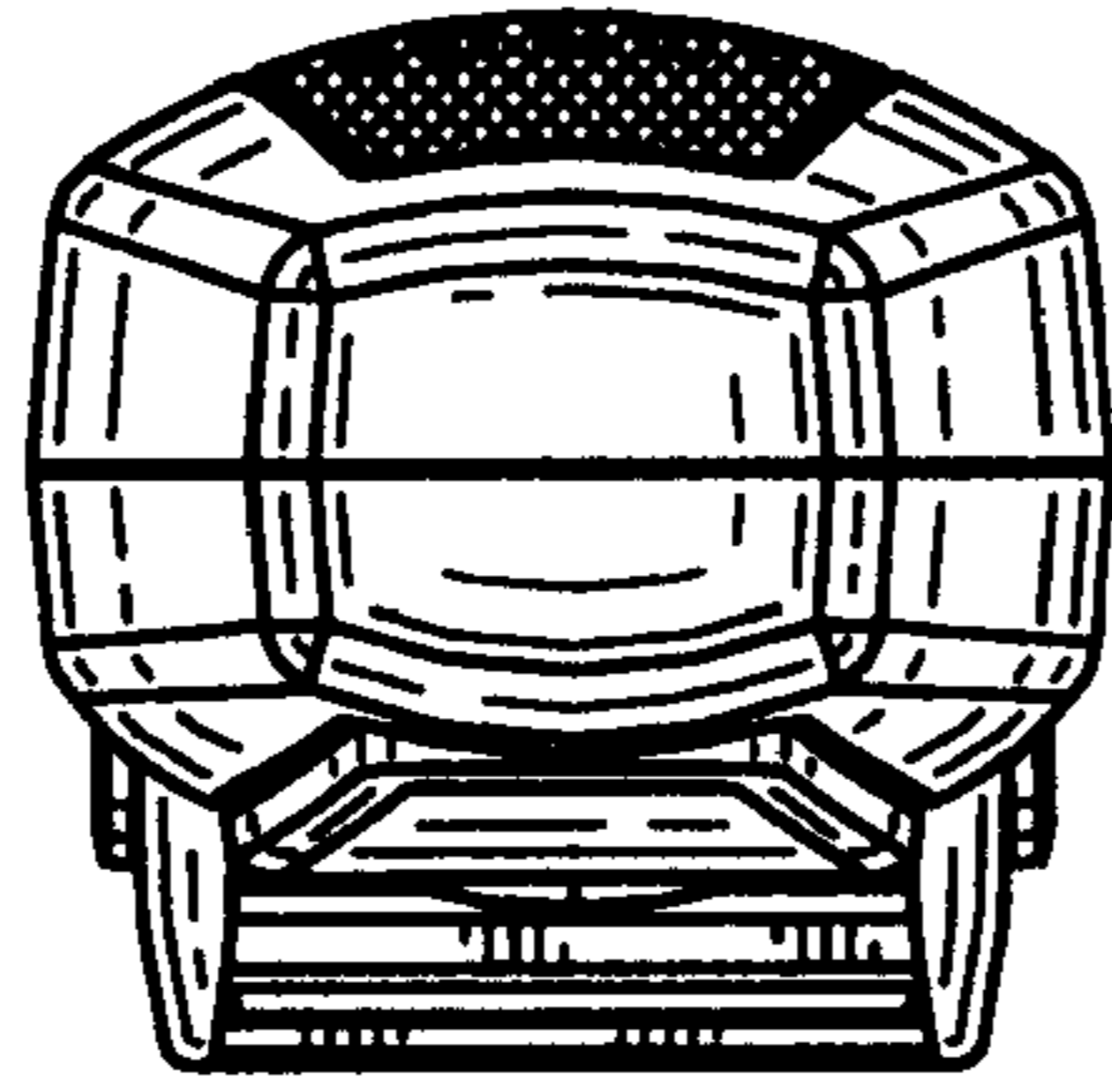

FIG. 5

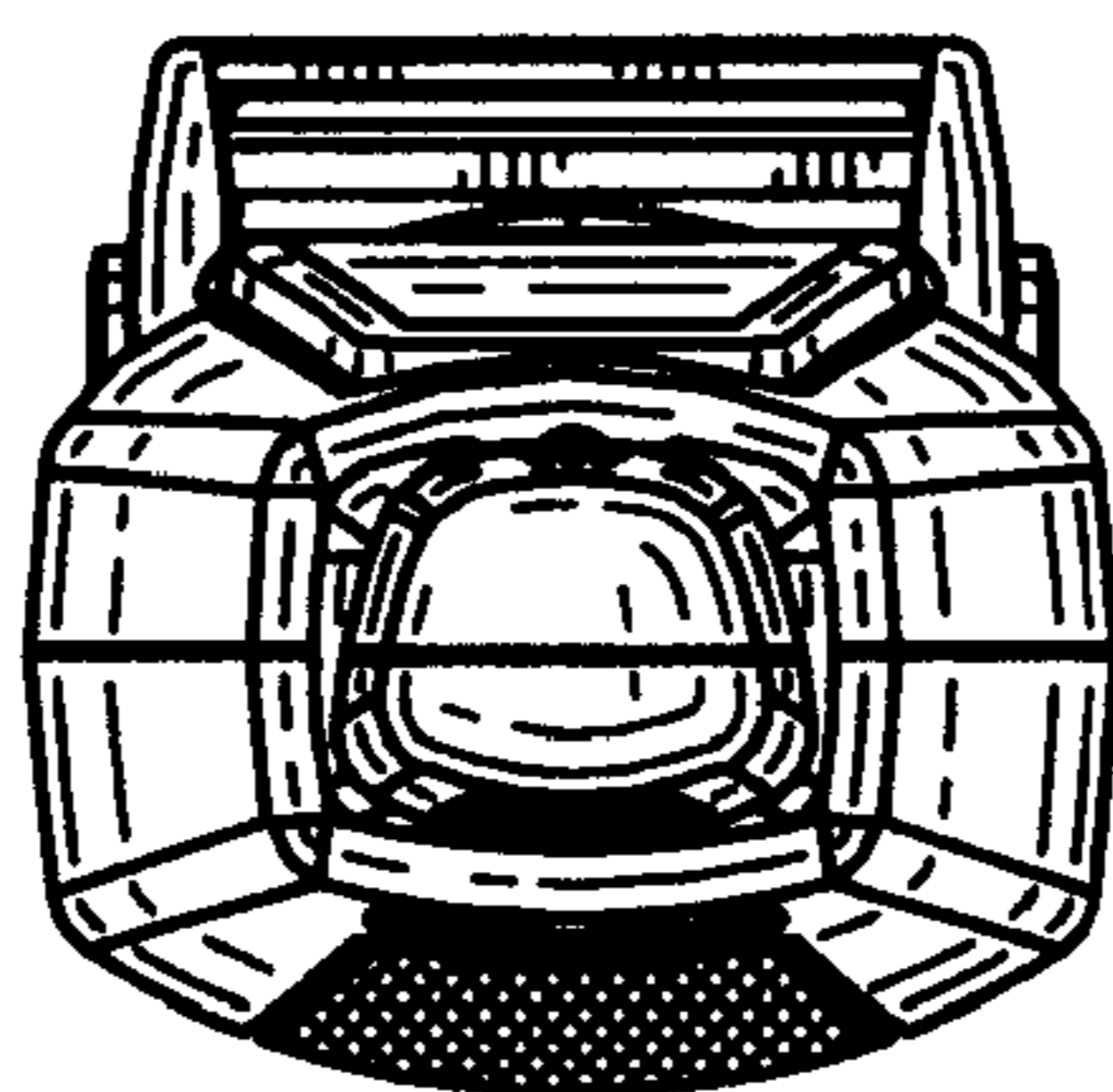

FIG. 6

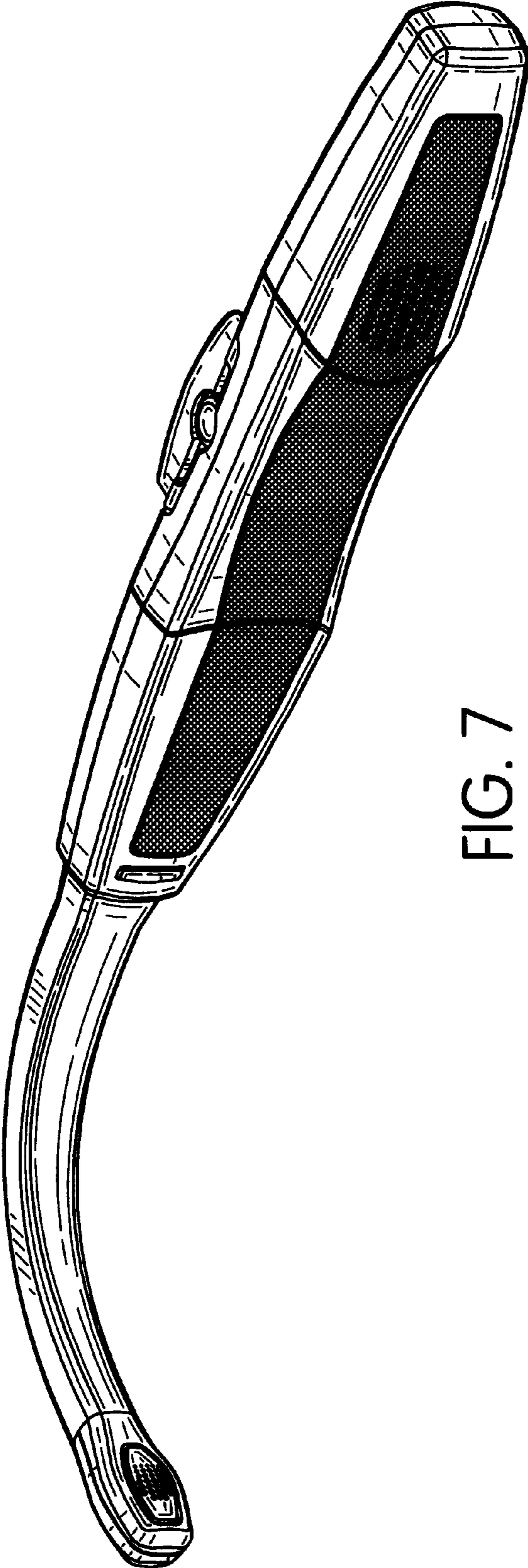

FIG. 7

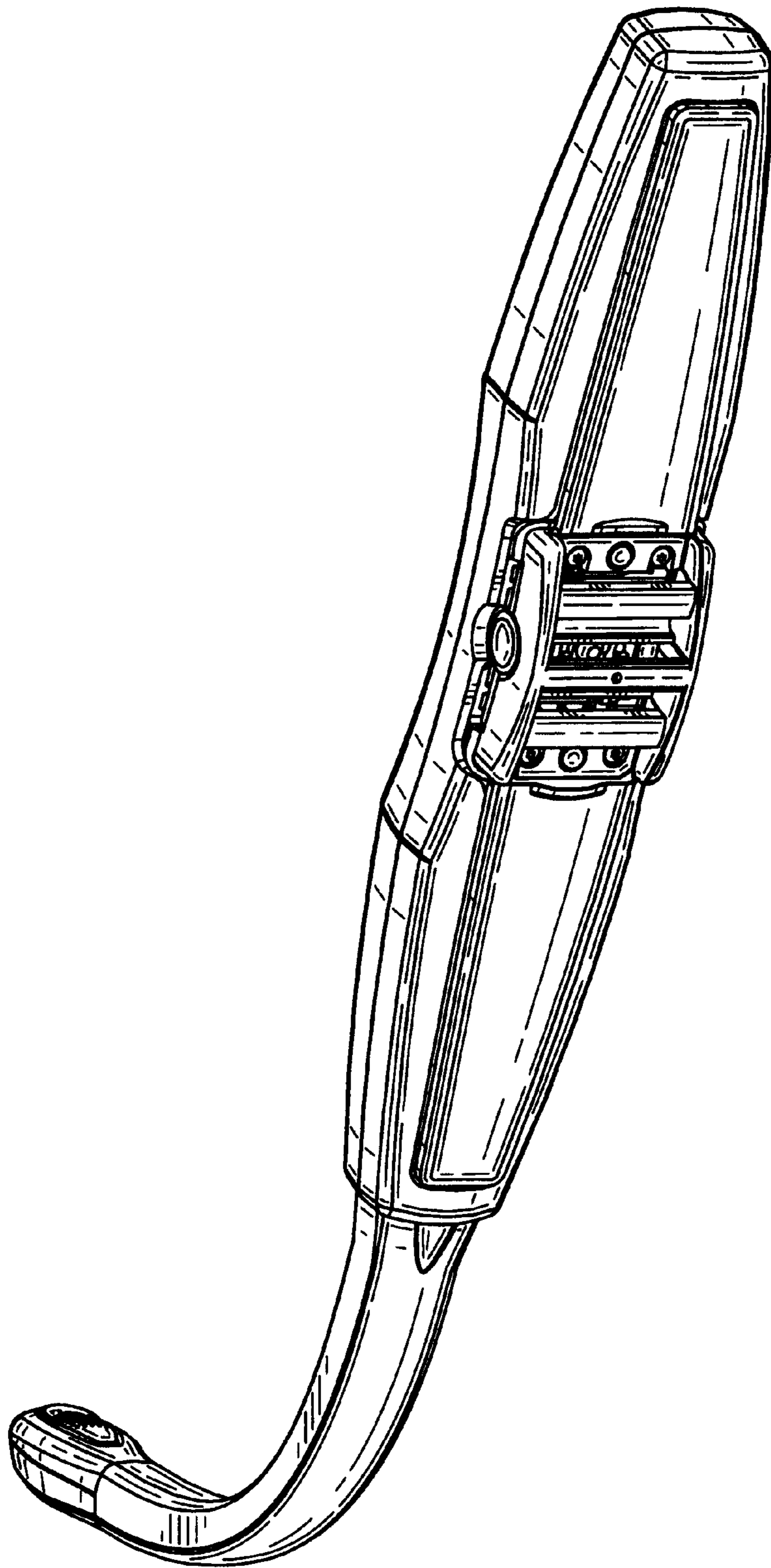

FIG. 8