

US00D535643S

(12) **United States Design Patent**  
**Dayan**

(10) **Patent No.:** **US D535,643 S**

(45) **Date of Patent:** **\*\* Jan. 23, 2007**

(54) **PORTABLE SPEAKER**

(75) Inventor: **Maurice S. Dayan**, Oakhurst, NJ (US)

(73) Assignee: **Intellectual Solutions, Inc.**

(\*\*) Term: **14 Years**

(21) Appl. No.: **29/231,834**

(22) Filed: **Jun. 10, 2005**

(51) **LOC (8) Cl.** ..... **14-01**

(52) **U.S. Cl.** ..... **D14/215; D14/138**

(58) **Field of Classification Search** ..... D14/204,  
D14/207, 209–216, 356, 138; 181/143–144,  
181/147–148, 150, 157, 198–199, 151, 153;  
381/300–302, 306, 333, 345, 361–364, 386–388,  
381/332, 336

See application file for complete search history.

(56) **References Cited**

**U.S. PATENT DOCUMENTS**

D360,209 S	*	7/1995	Sheu	.....	D14/215
D475,037 S	*	5/2003	Leung	.....	D14/214
D495,674 S	*	9/2004	Yoo et al.	.....	D14/138
D497,154 S	*	10/2004	Lin et al.	.....	D14/204
D498,471 S	*	11/2004	Solland et al.	.....	D14/215
D501,837 S	*	2/2005	Kim et al.	.....	D14/138

\* cited by examiner

*Primary Examiner*—Nanda Bondade

(74) *Attorney, Agent, or Firm*—Wolf, Block, Schorr & Solis-Cohen

(57) **CLAIM**

The ornamental design for a portable speaker, as shown and described.

**DESCRIPTION**

FIG. 1 is a right side perspective view of a portable speaker showing my new design;  
 FIG. 2 is top view thereof;  
 FIG. 3 is a bottom view thereof;  
 FIG. 4 is a left side view thereof;  
 FIG. 5 is a right side view thereof;  
 FIG. 6 is a front view thereof;  
 FIG. 7 is a rear view thereof;  
 FIG. 8 is a left side perspective view of FIG. 1 in an open position;  
 FIG. 9 is a bottom view of FIG. 8;  
 FIG. 10 is a top view of FIG. 8;  
 FIG. 11 is a left side view of FIG. 8;  
 FIG. 12 is a right side view of FIG. 8;  
 FIG. 13 is a rear view of FIG. 8; and,  
 FIG. 14 is a front view of FIG. 8.

**1 Claim, 12 Drawing Sheets**

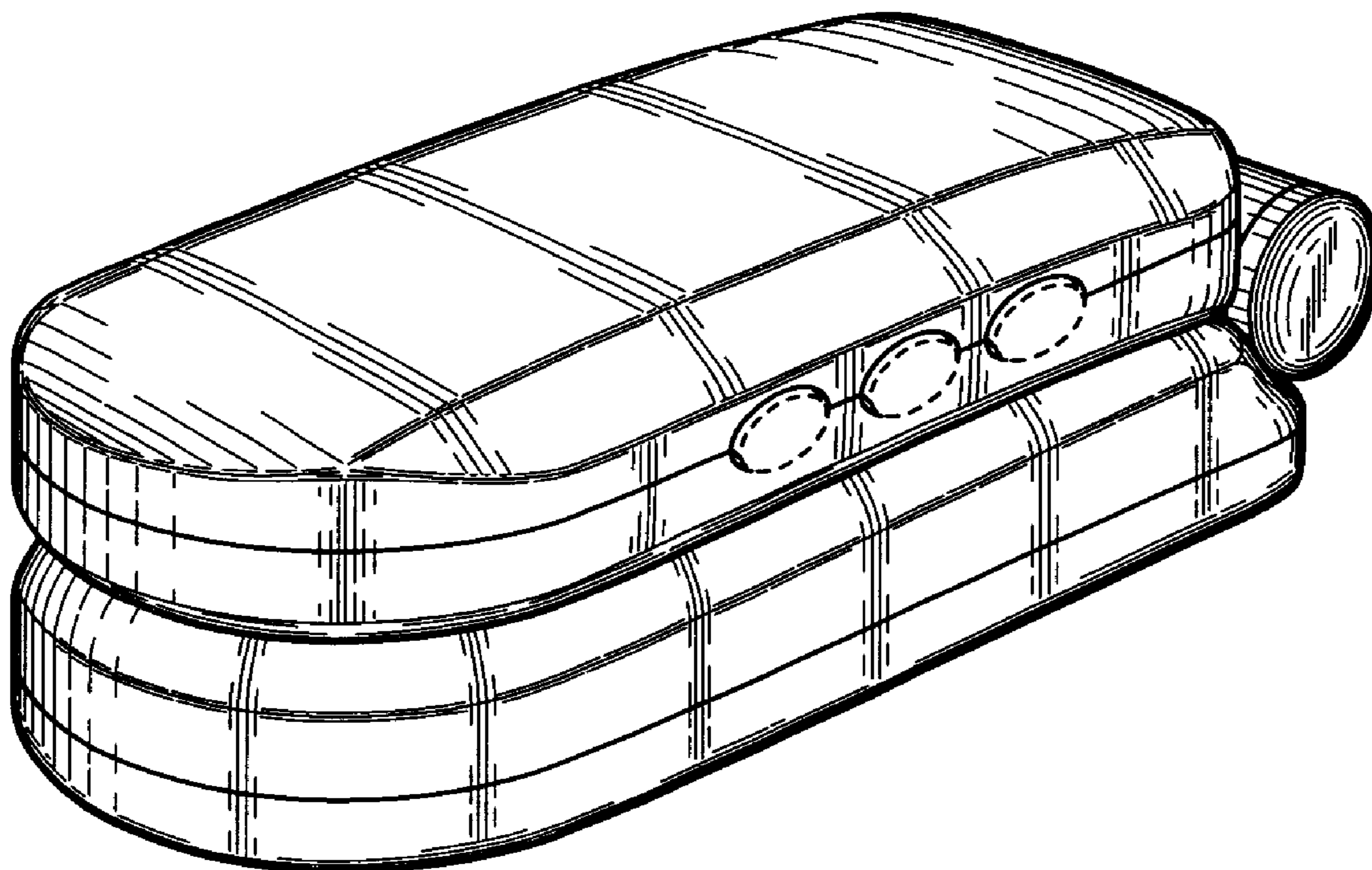

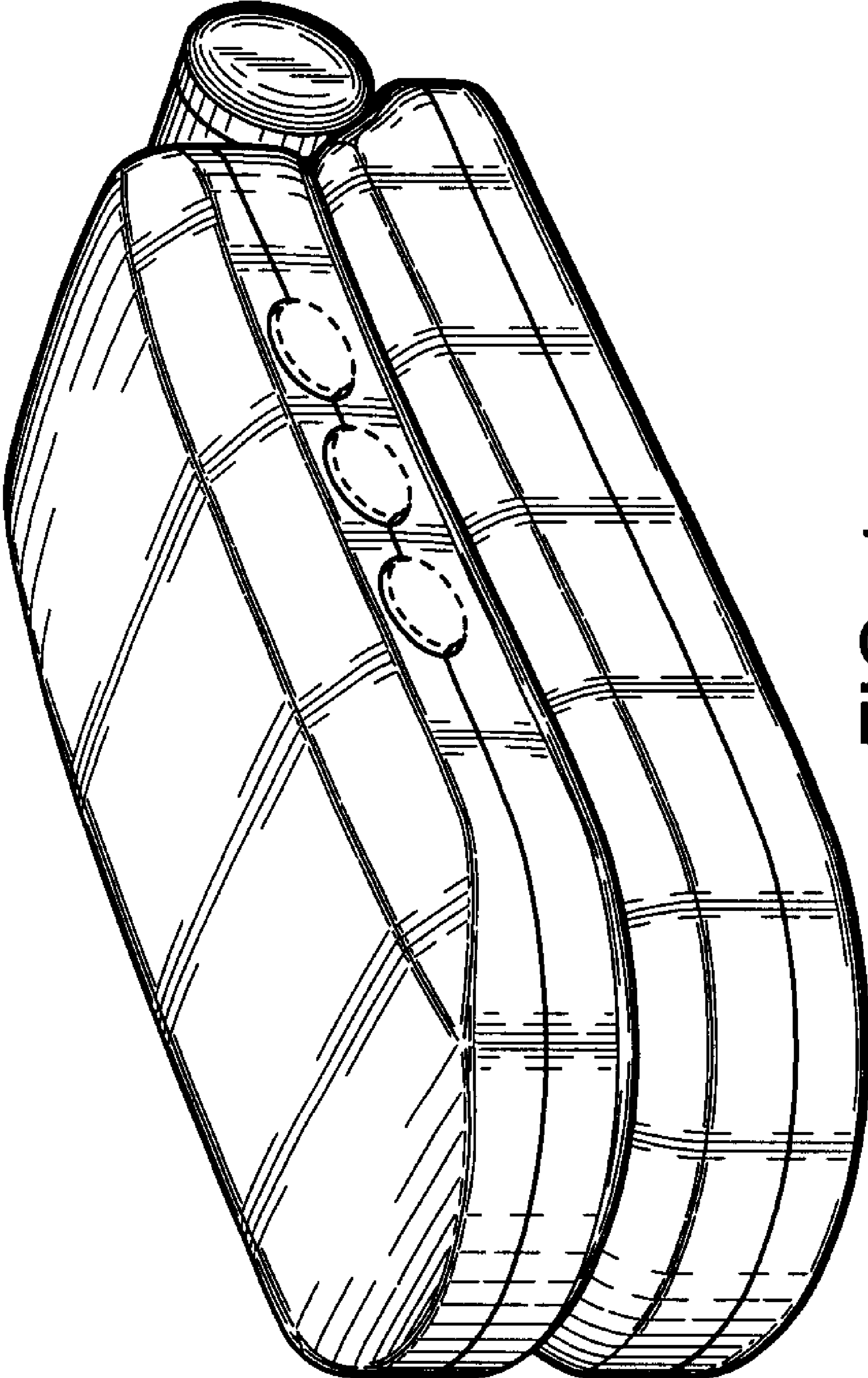

FIG. 1

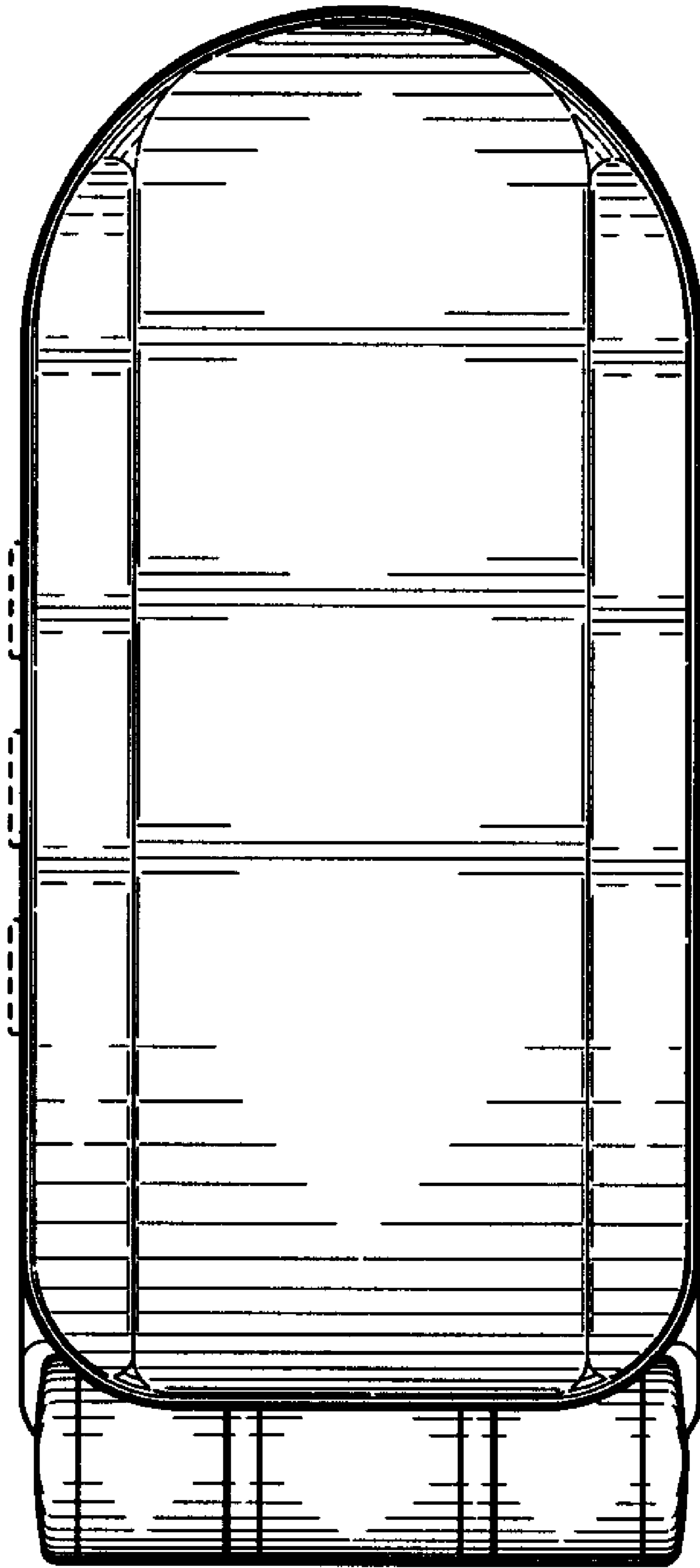

FIG. 2

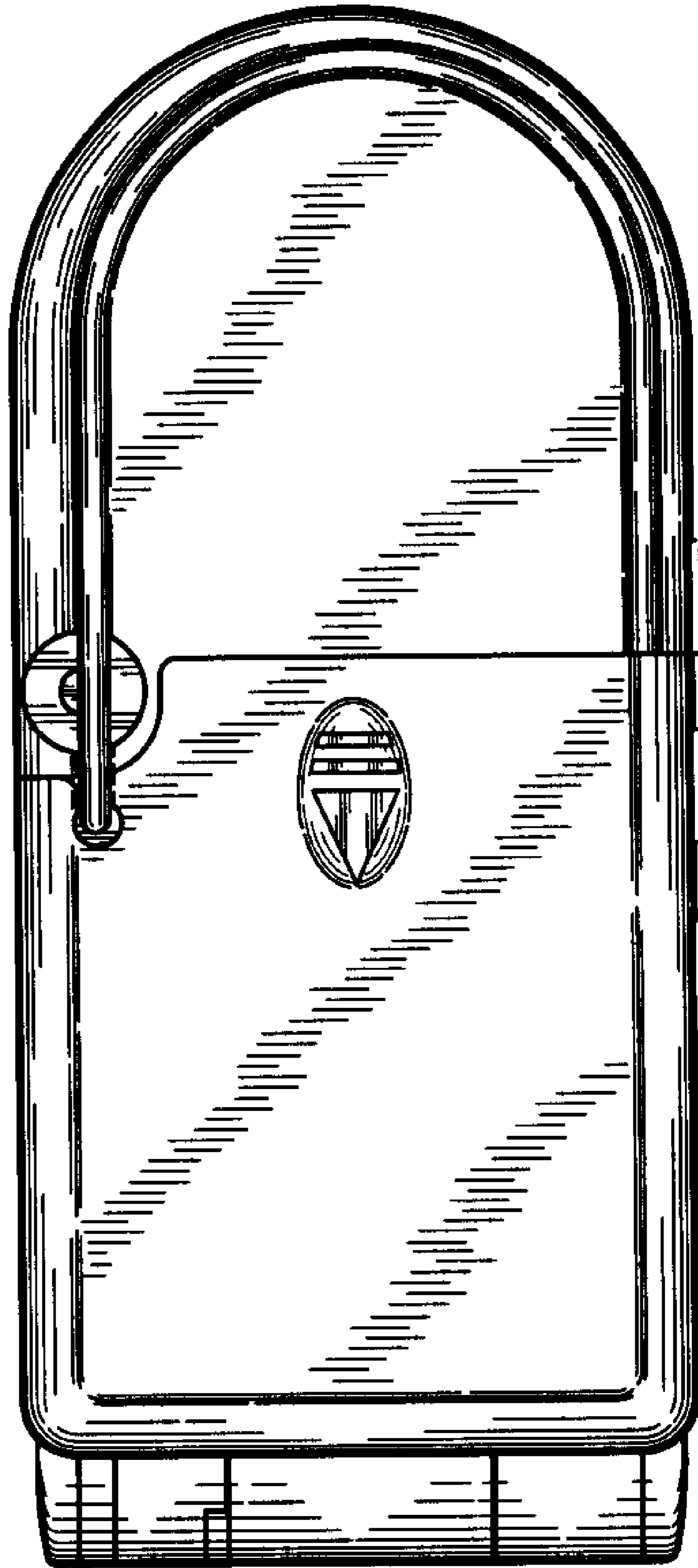

FIG. 3

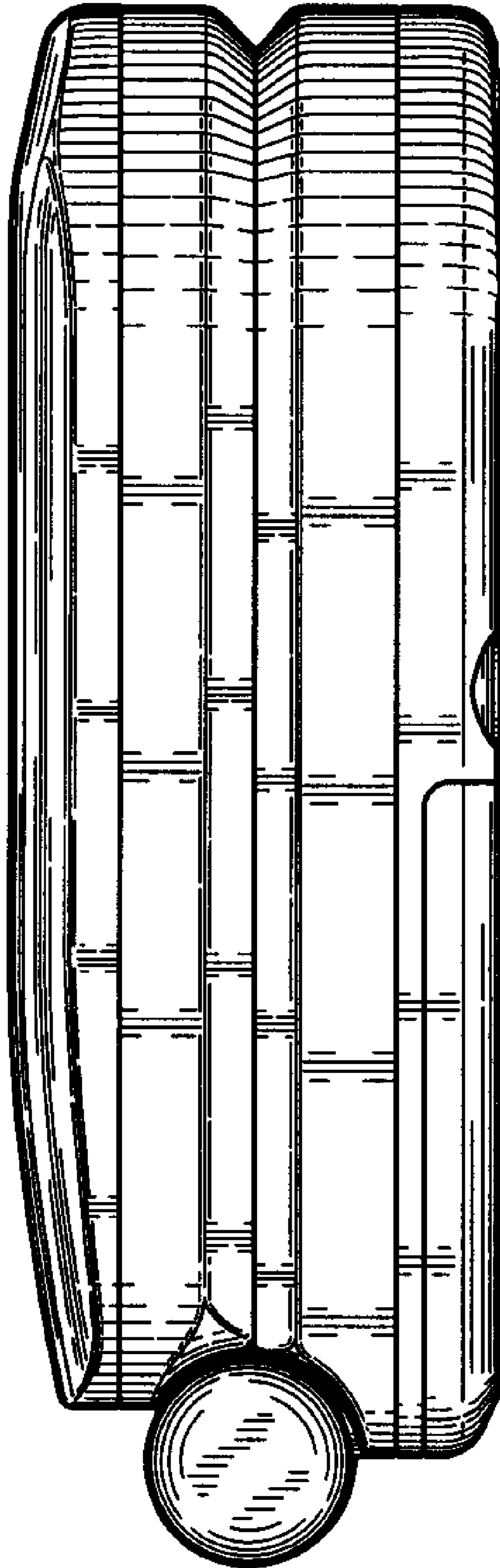

FIG. 4

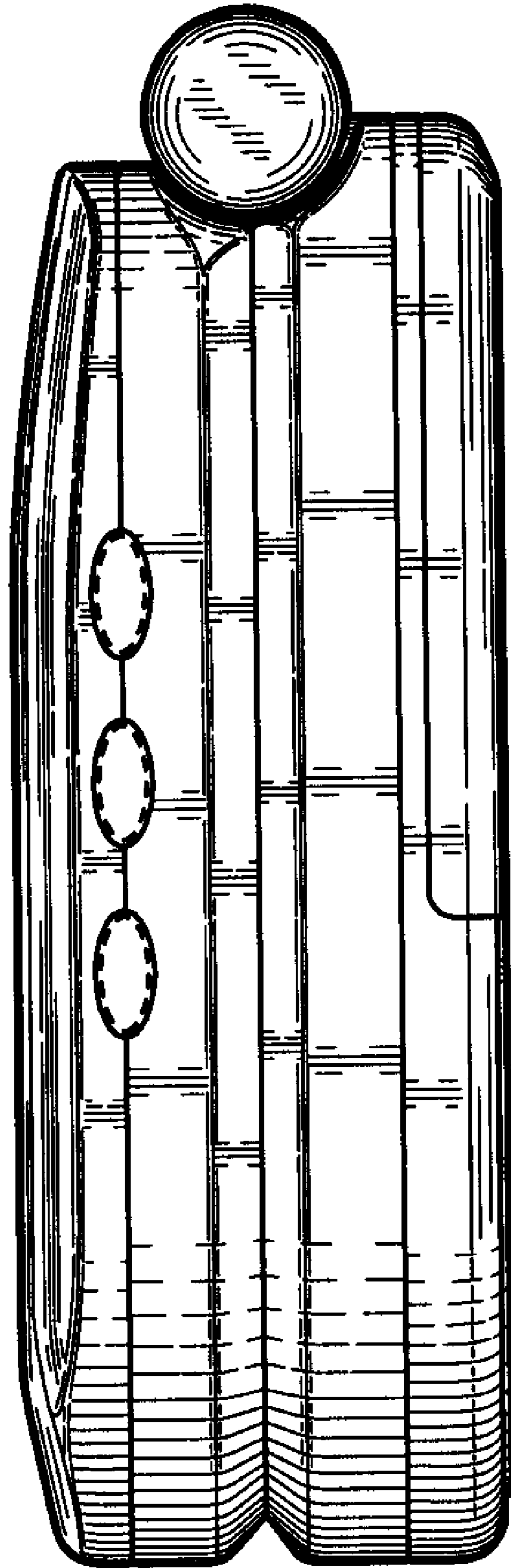

FIG. 5

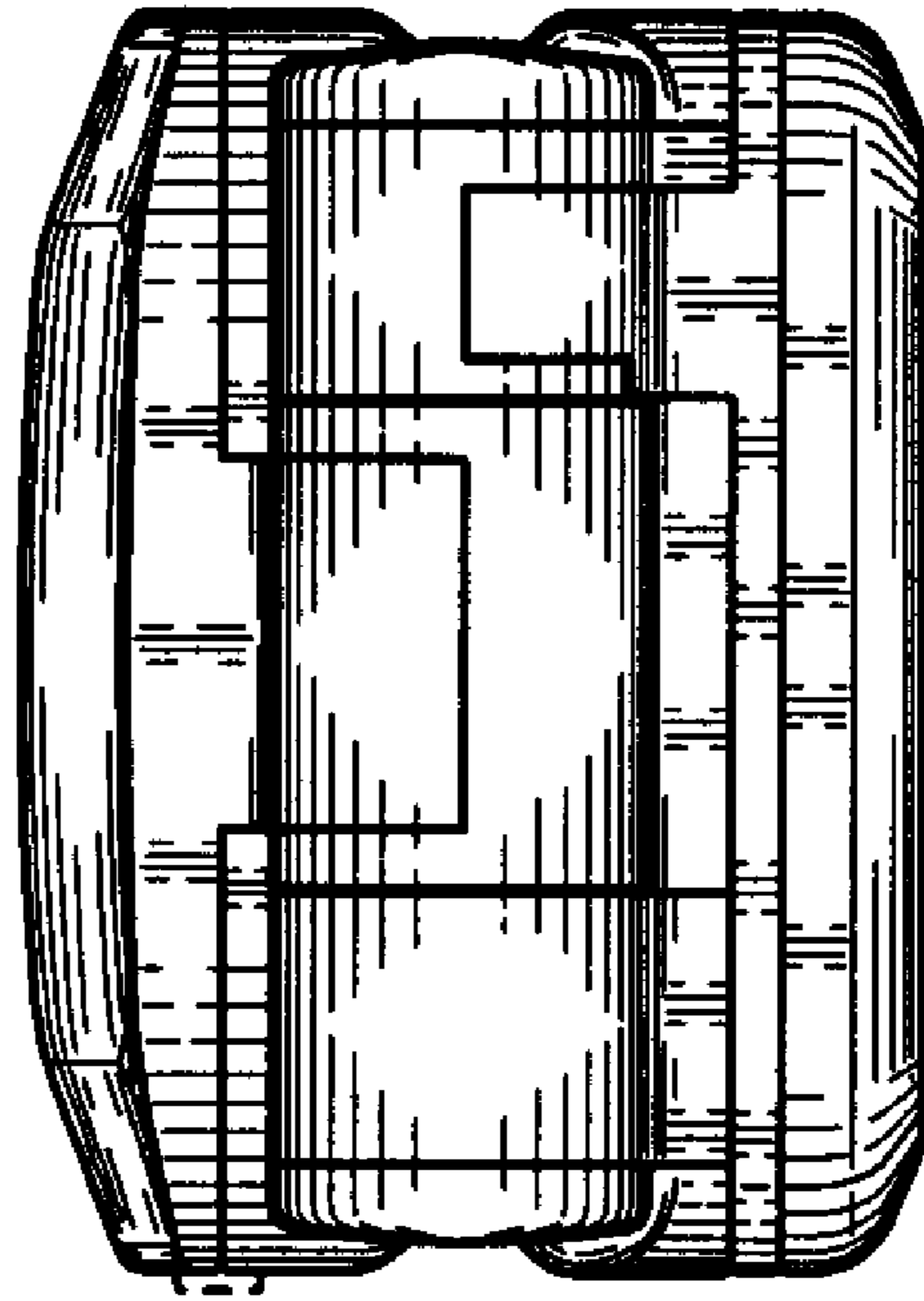

FIG. 6

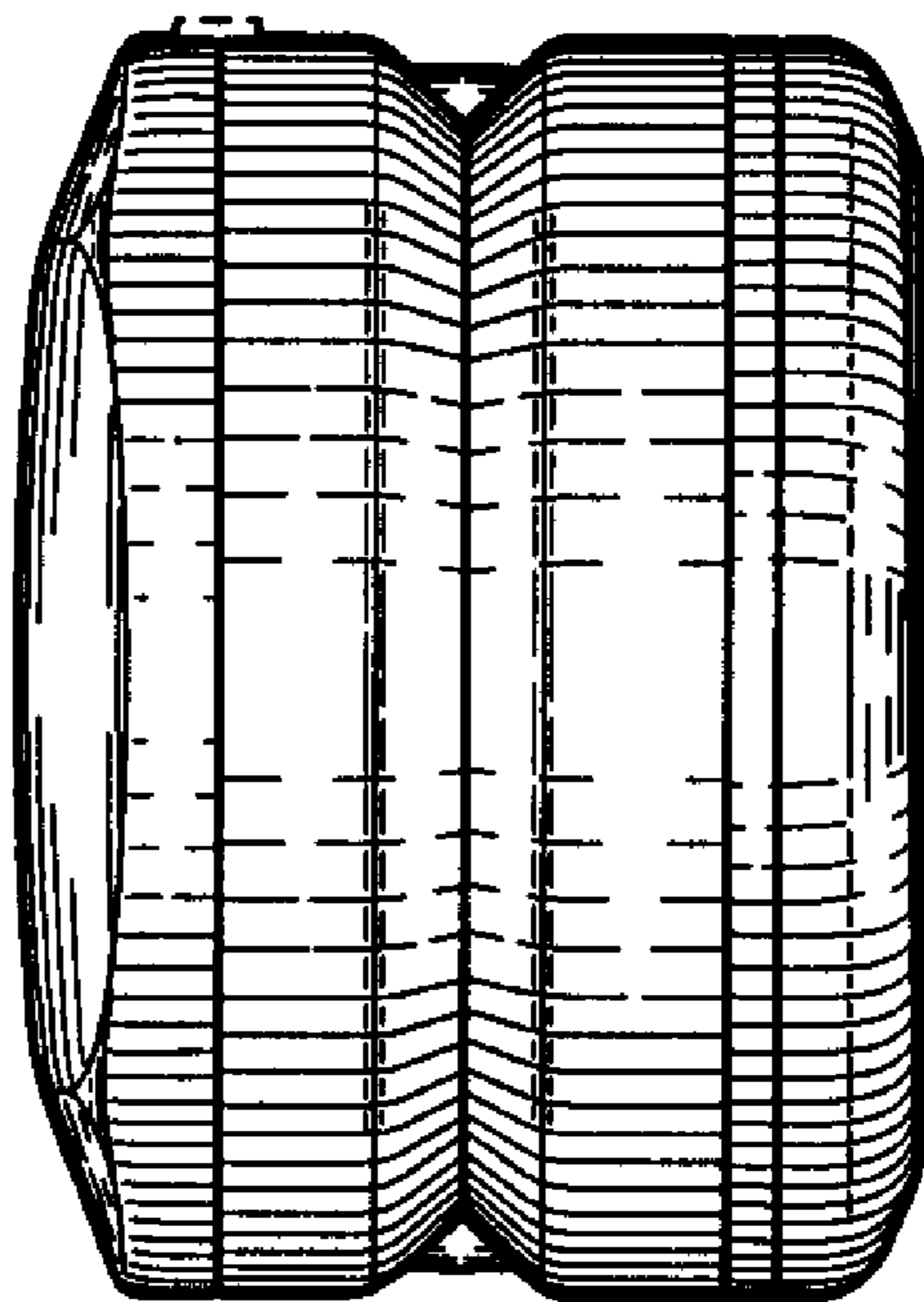

FIG. 7

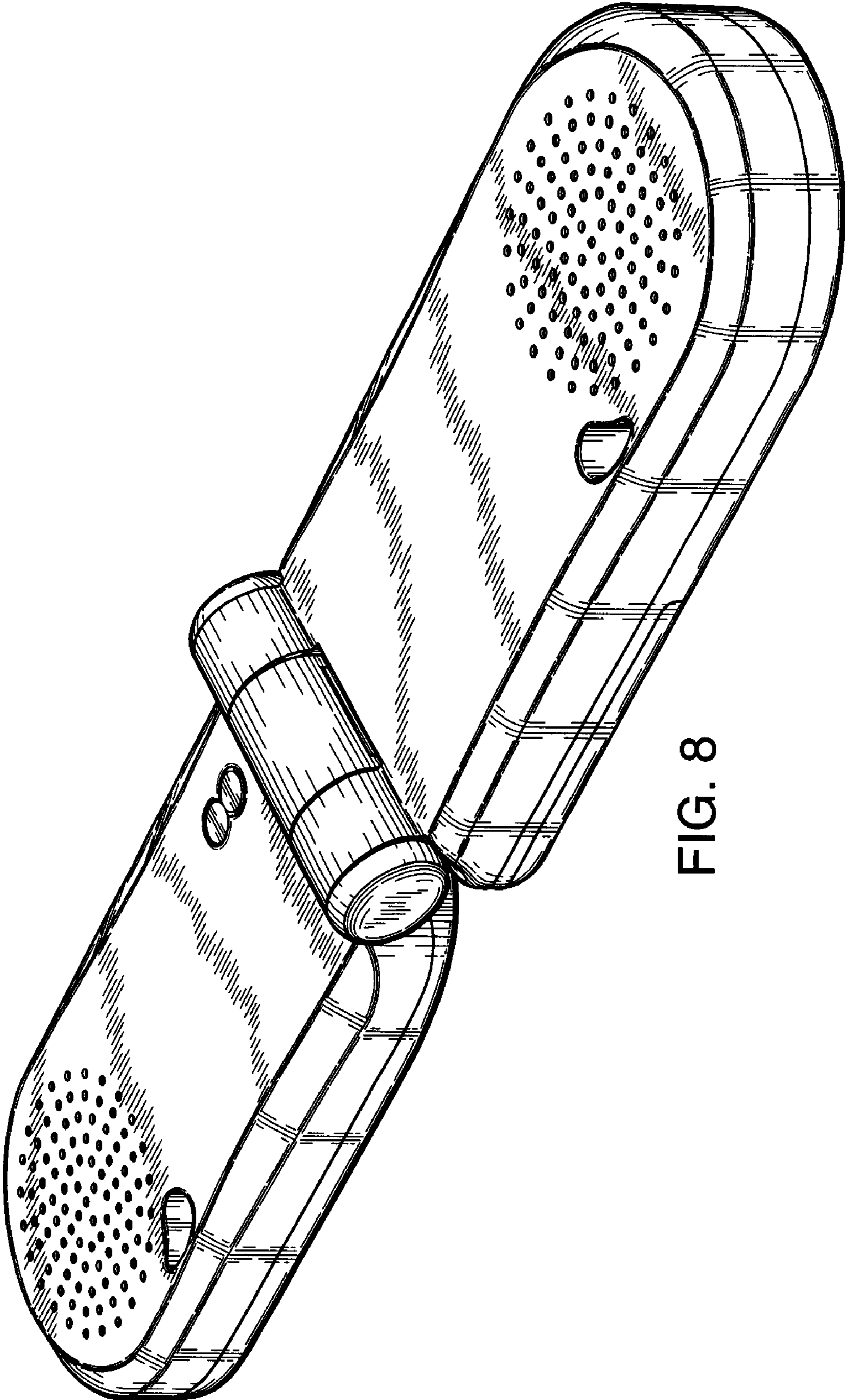

FIG. 8



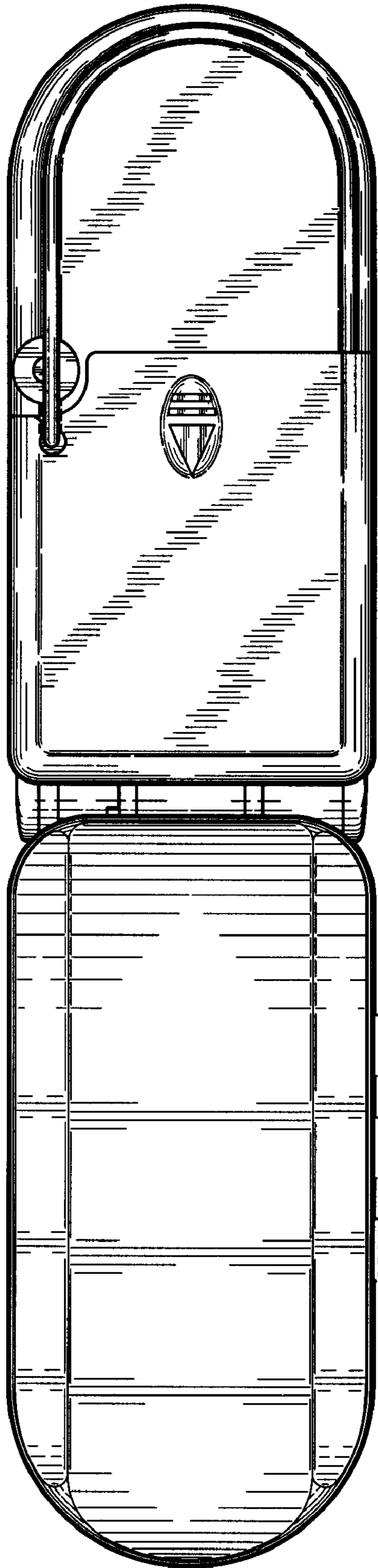

FIG. 9

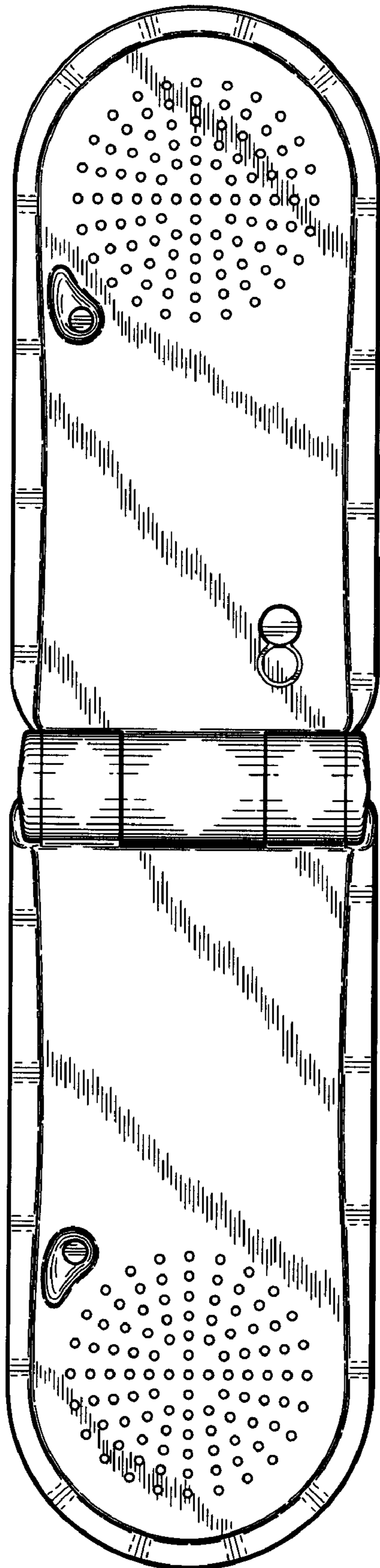

FIG. 10

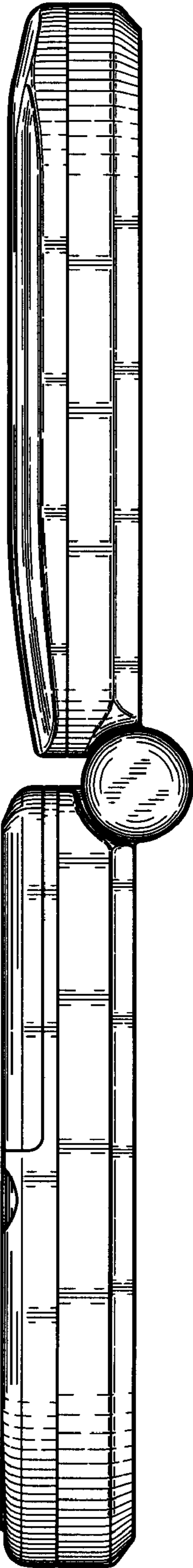

FIG. 11

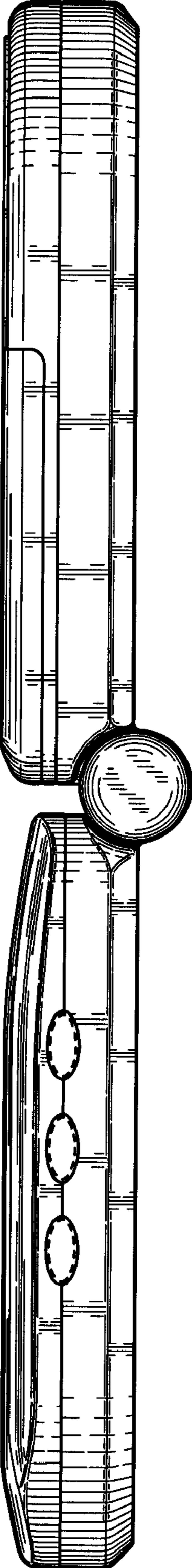

FIG. 12

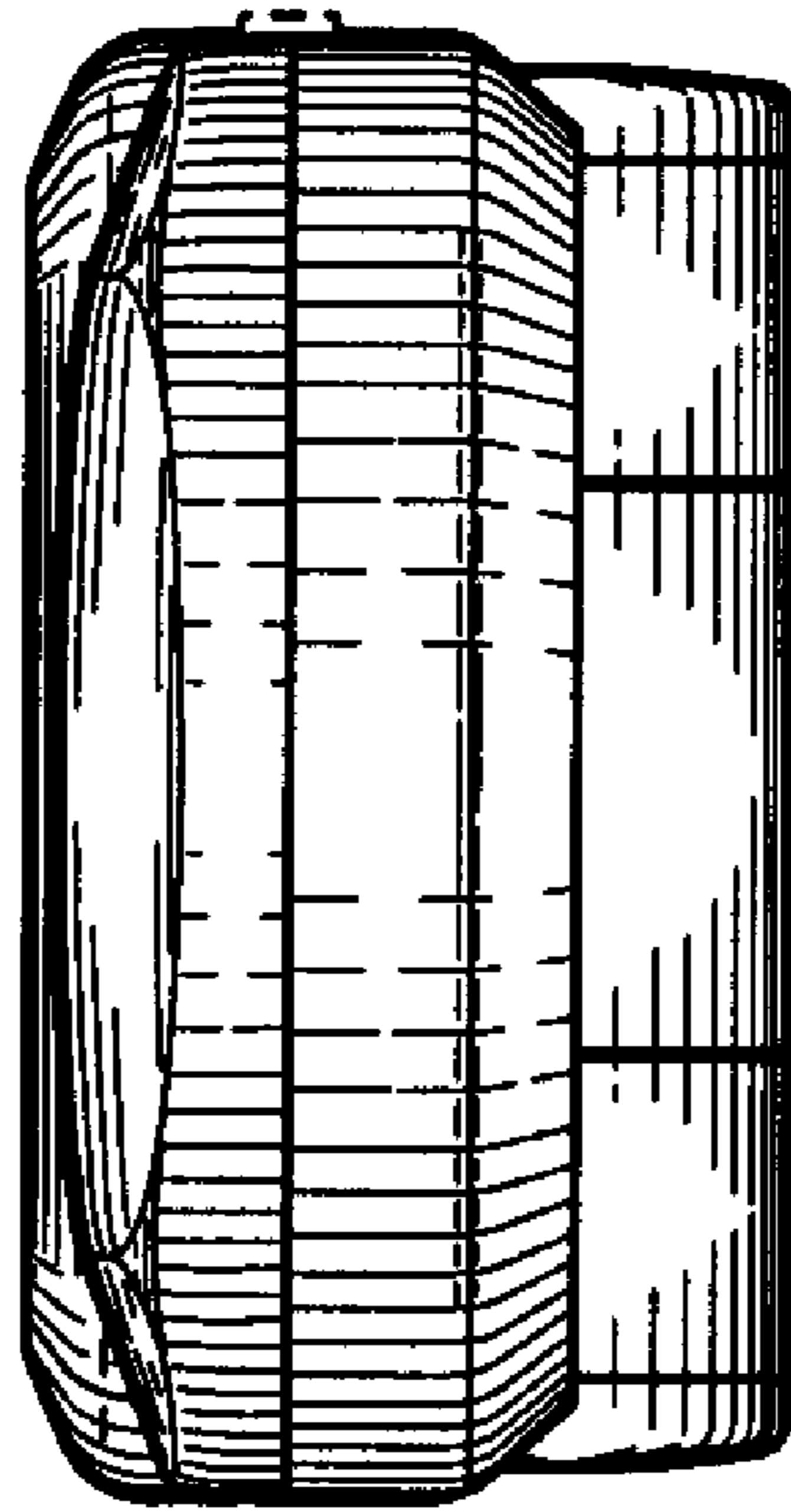

FIG. 14

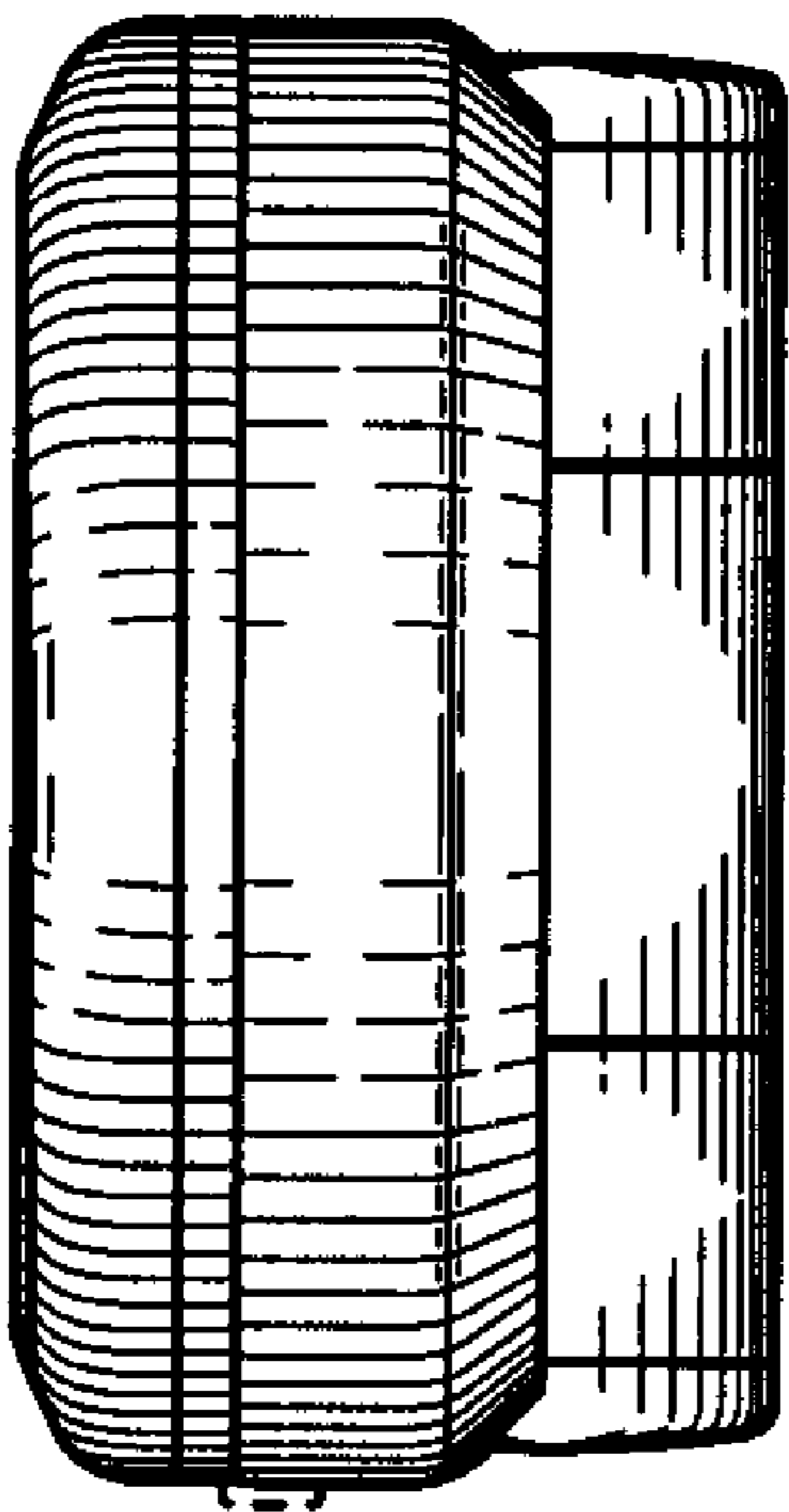

FIG. 13