

US00D535571S

(12) **United States Design Patent**
Simon et al.

(10) **Patent No.:** **US D535,571 S**
(45) **Date of Patent:** **** Jan. 23, 2007**

- (54) **WATERING TIMER HOUSING**
- (75) Inventors: **Timothy M. Simon**, San Francisco, CA (US); **Matthew T. Fisher**, Reno, NV (US)
- (73) Assignee: **Tim Simon, Inc.**, San Francisco, CA (US)
- (**) Term: **14 Years**

5,363,290 A	*	11/1994	Doup et al.	700/16
D366,837 S	*	2/1996	Cooney	D10/40
5,602,728 A	*	2/1997	Madden et al.	700/16
D380,397 S	*	7/1997	Chan	D10/40
D406,567 S	*	3/1999	Roman	D13/162.1
5,921,280 A	*	7/1999	Ericksen et al.	137/624.11
6,259,955 B1	*	7/2001	Brundisini et al.	700/15
6,337,635 B1	*	1/2002	Ericksen et al.	340/825.69
6,507,775 B1	*	1/2003	Simon et al.	700/284
D492,264 S	*	6/2004	Perez et al.	D13/162
D497,319 S	*	10/2004	Shaanan	D10/104
D513,497 S	*	1/2006	Whitehouse	D13/162

- (21) Appl. No.: **29/244,384**
- (22) Filed: **Dec. 8, 2005**

- (51) **LOC (8) Cl.** **10-03**
- (52) **U.S. Cl.** **D10/40**
- (58) **Field of Classification Search** D10/40, D10/106; D13/162, 162.1; 700/284; 239/69, 239/70; 368/187, 285, 82-84, 94-123, 276-278, 368/316, 317
See application file for complete search history.

* cited by examiner

Primary Examiner—Lucy Lieberman
(74) *Attorney, Agent, or Firm*—James F. Hann; Haynes Beffel & Wolfeld LLP

(57) **CLAIM**

The ornamental design for a watering timer housing, as shown and described.

DESCRIPTION

The watering timer housing is used to contain watering timer. The watering timer is typically used to control lawn sprinklers and drip irrigation systems for lawns and plants. FIG. 1 is a front, right side, bottom perspective view of a watering timer housing showing our new design; FIG. 2 is a front elevational view thereof; FIG. 3 is a bottom plan view thereof; FIG. 4 is a right side elevational view thereof; FIG. 5 is a left side elevation thereof; FIG. 6 is a top plan view thereof; and, FIG. 7 is a back elevational view thereof.

(56) **References Cited**
U.S. PATENT DOCUMENTS

D241,323 S	*	9/1976	Sparks	D10/106
4,633,905 A	*	1/1987	Wang	137/624.11
D291,069 S	*	7/1987	Fenne	D10/40
4,827,155 A	*	5/1989	Firebaugh	307/141.4
4,858,207 A	*	8/1989	Buchner	368/10
4,943,917 A	*	7/1990	Mylne, III	700/284
D310,791 S	*	9/1990	Farrell et al.	D10/106
5,025,361 A	*	6/1991	Pitman et al.	700/14
D321,489 S	*	11/1991	Heimbürger et al.	D10/97
D329,226 S	*	9/1992	Holbrook	D13/162
5,293,554 A	*	3/1994	Nicholson	700/284

1 Claim, 4 Drawing Sheets

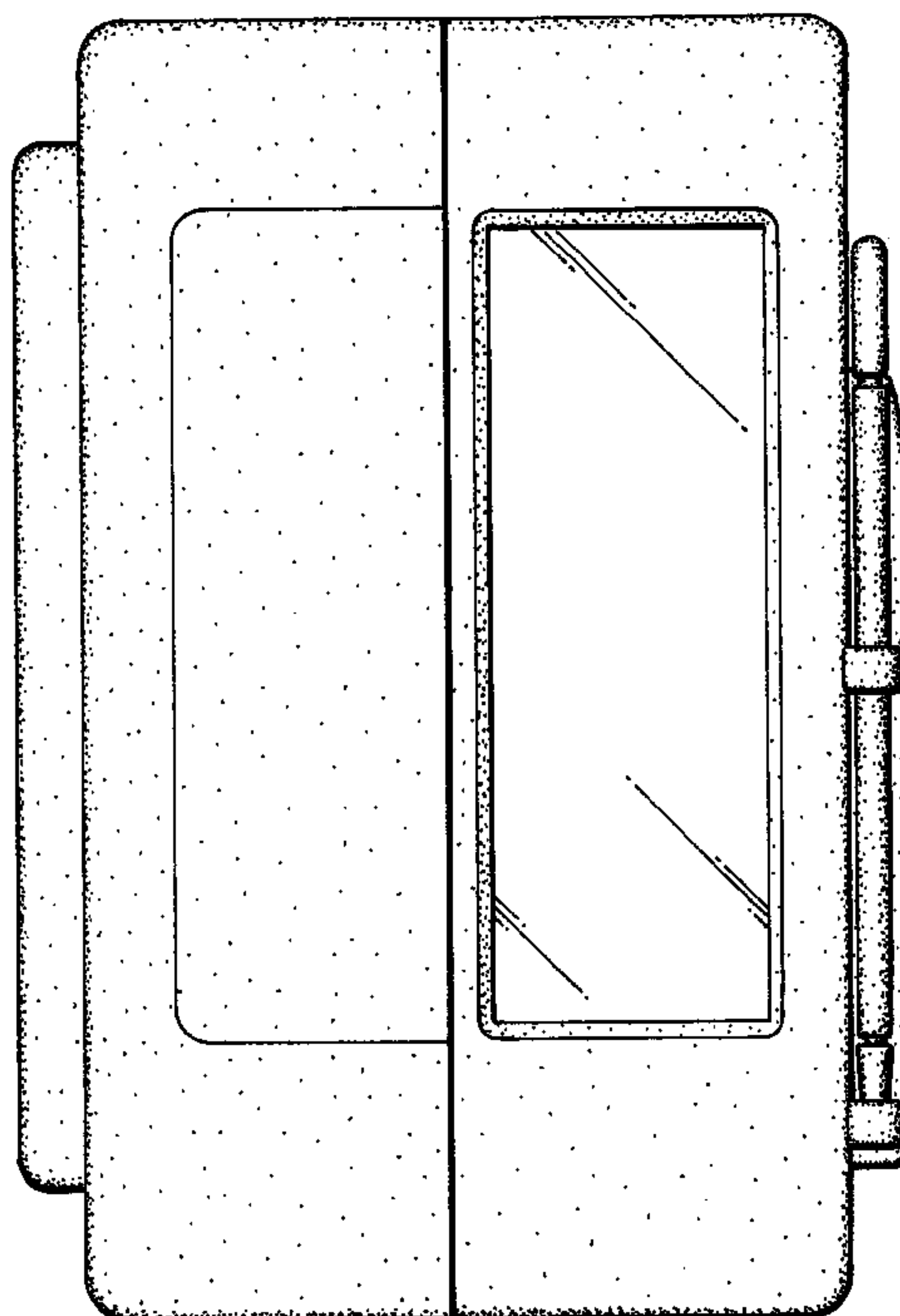

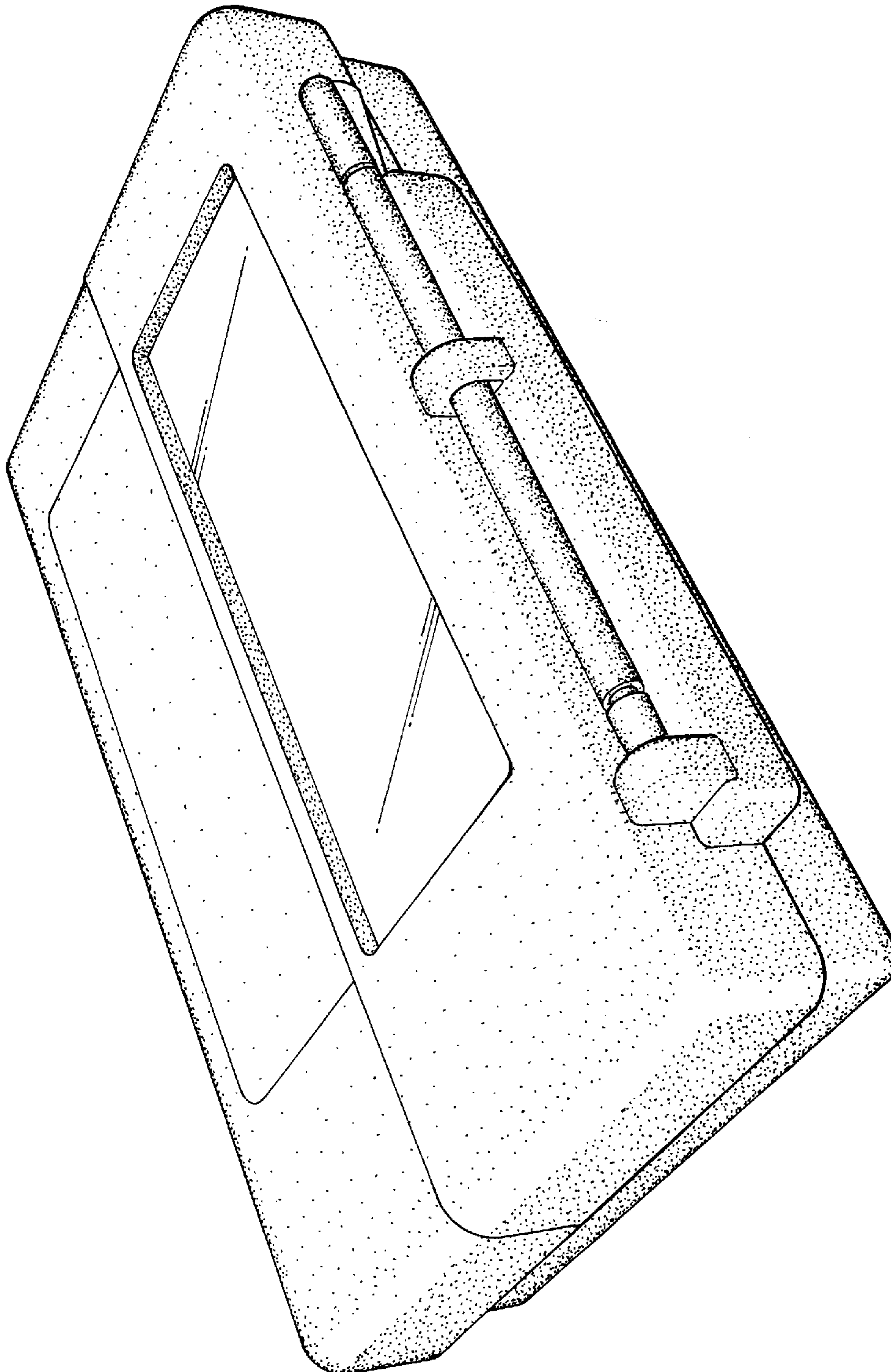

FIG. 1

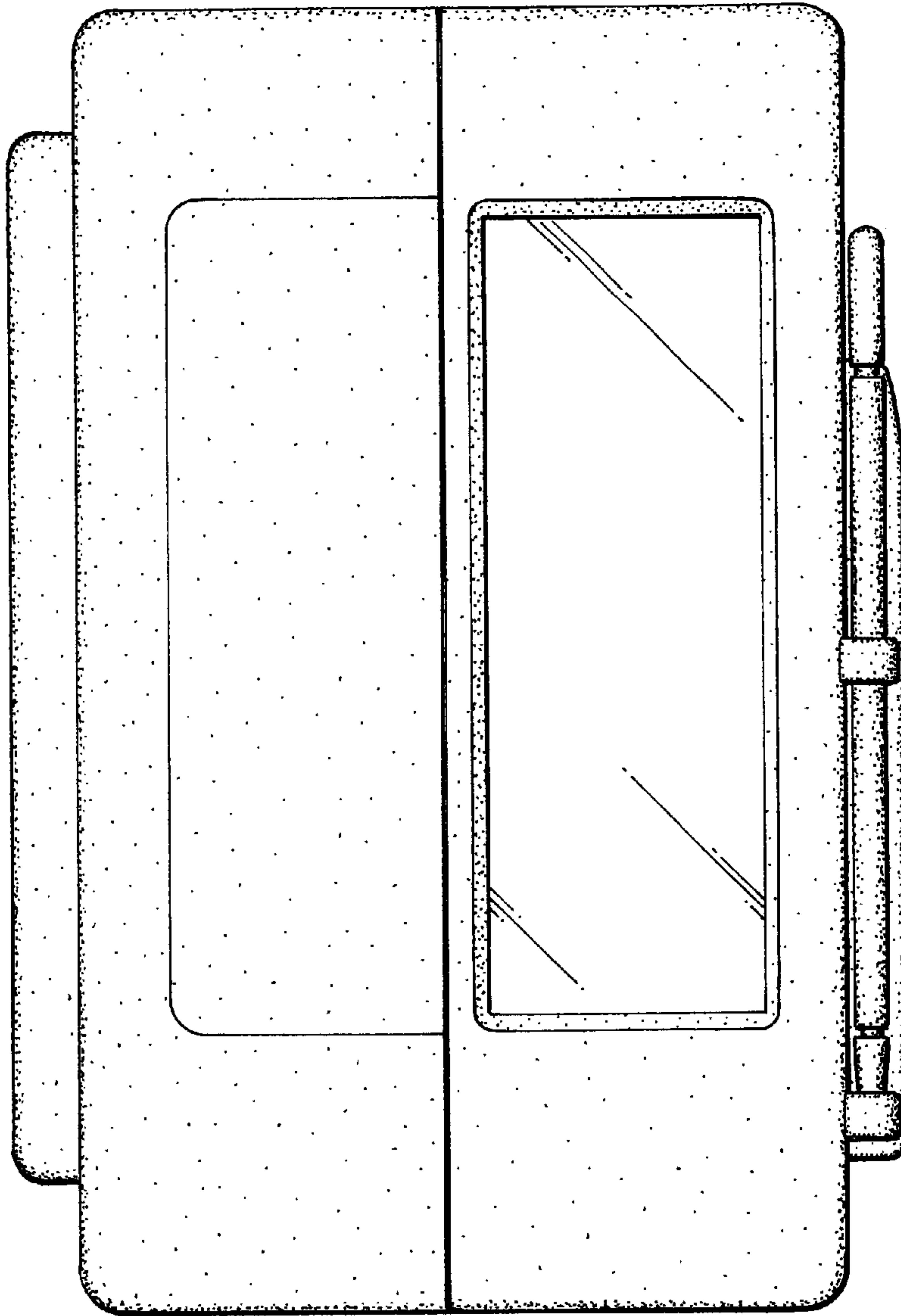

FIG. 2

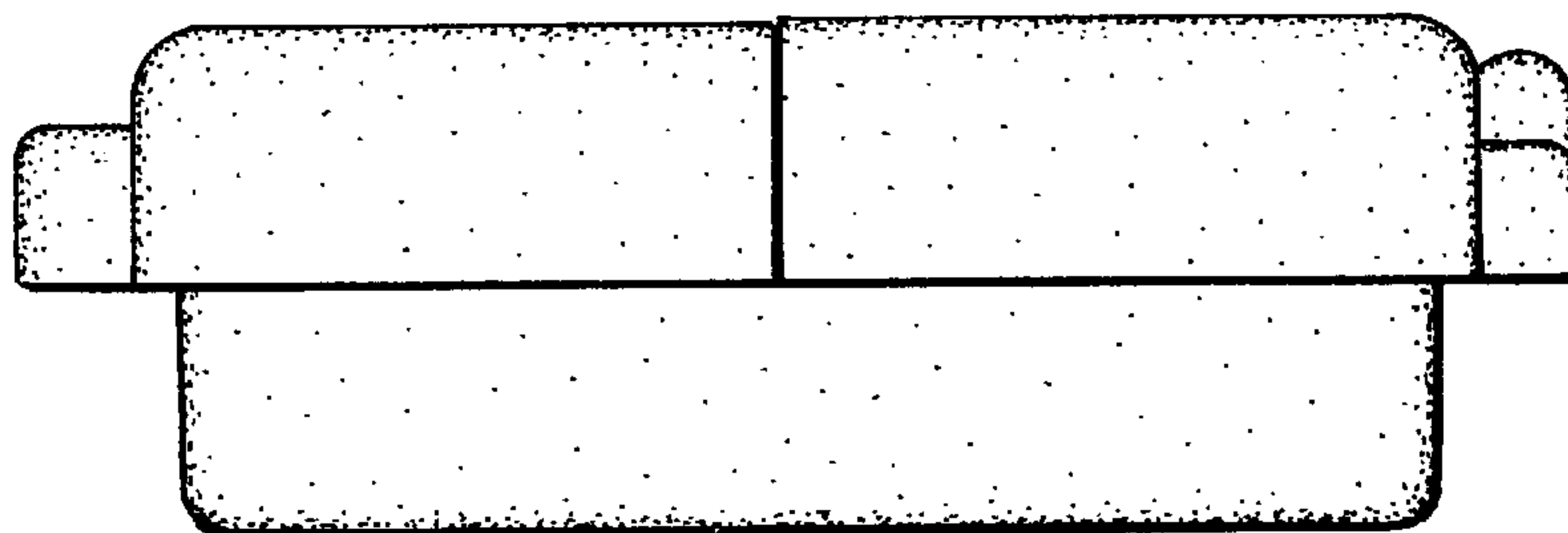

FIG. 3

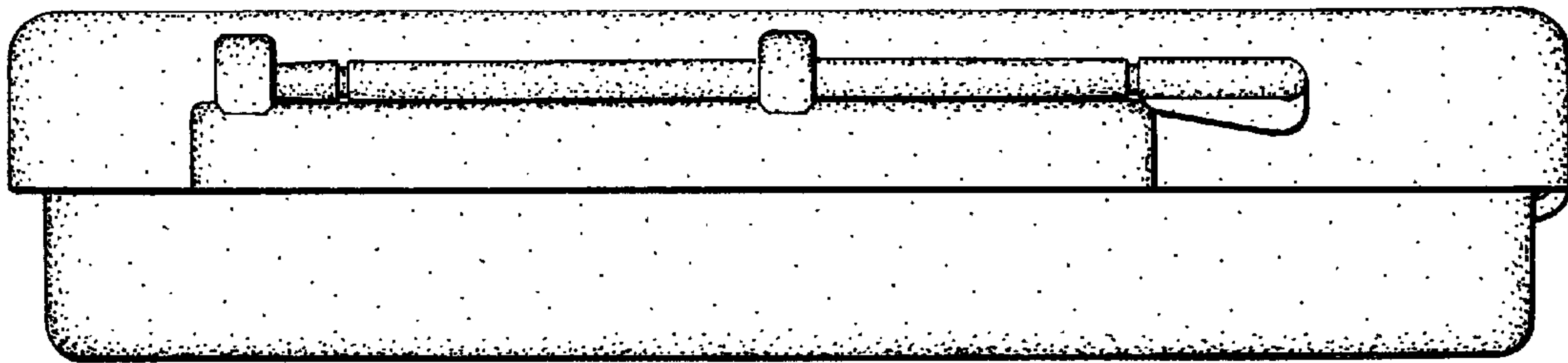

FIG. 4

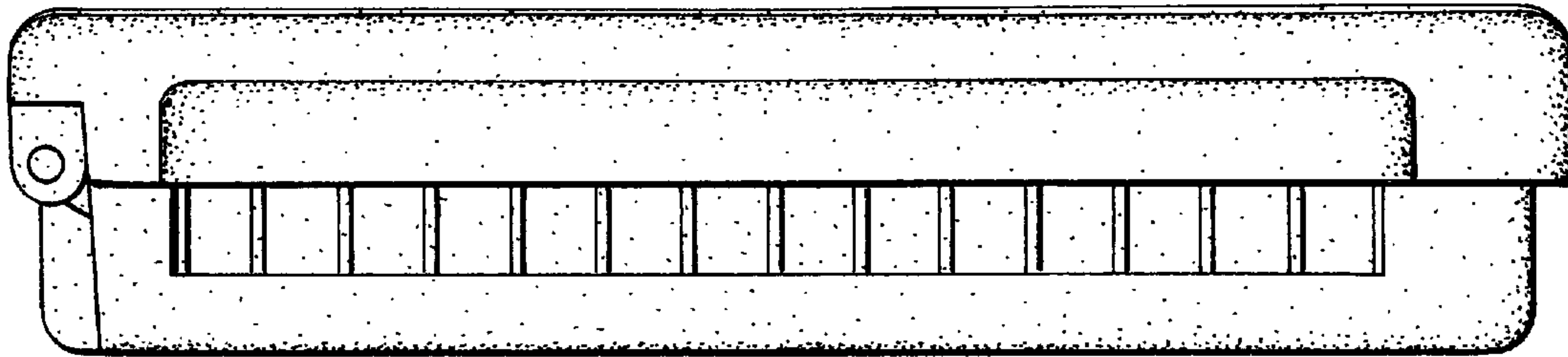

FIG. 5

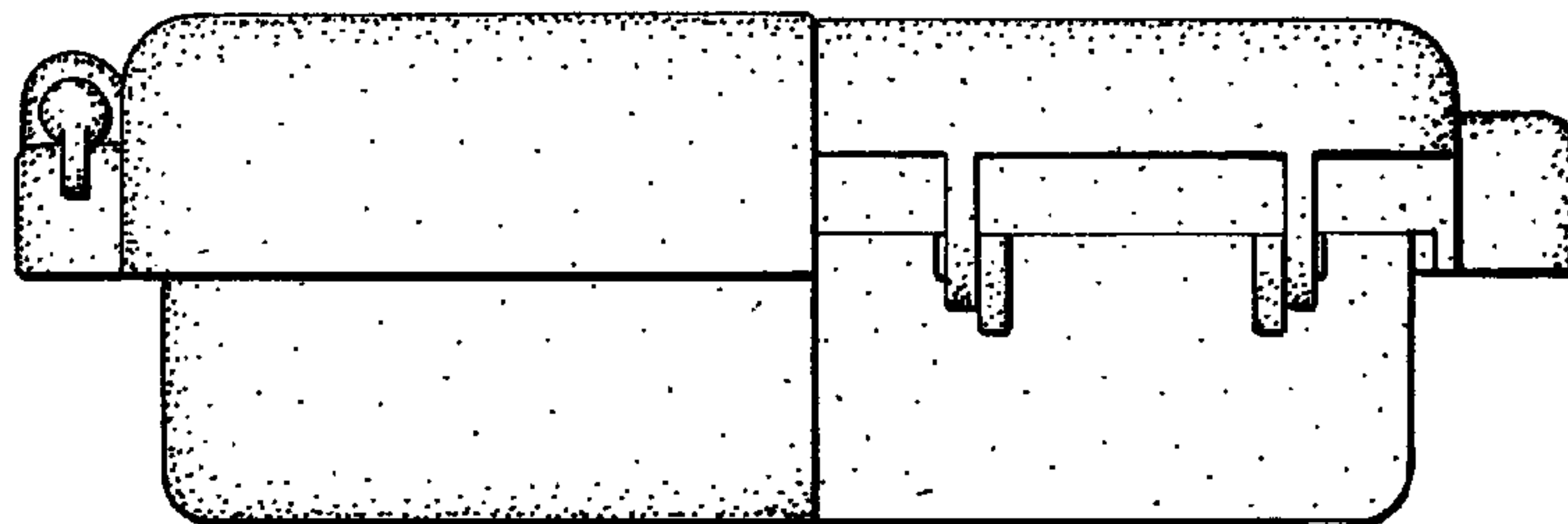

FIG. 6

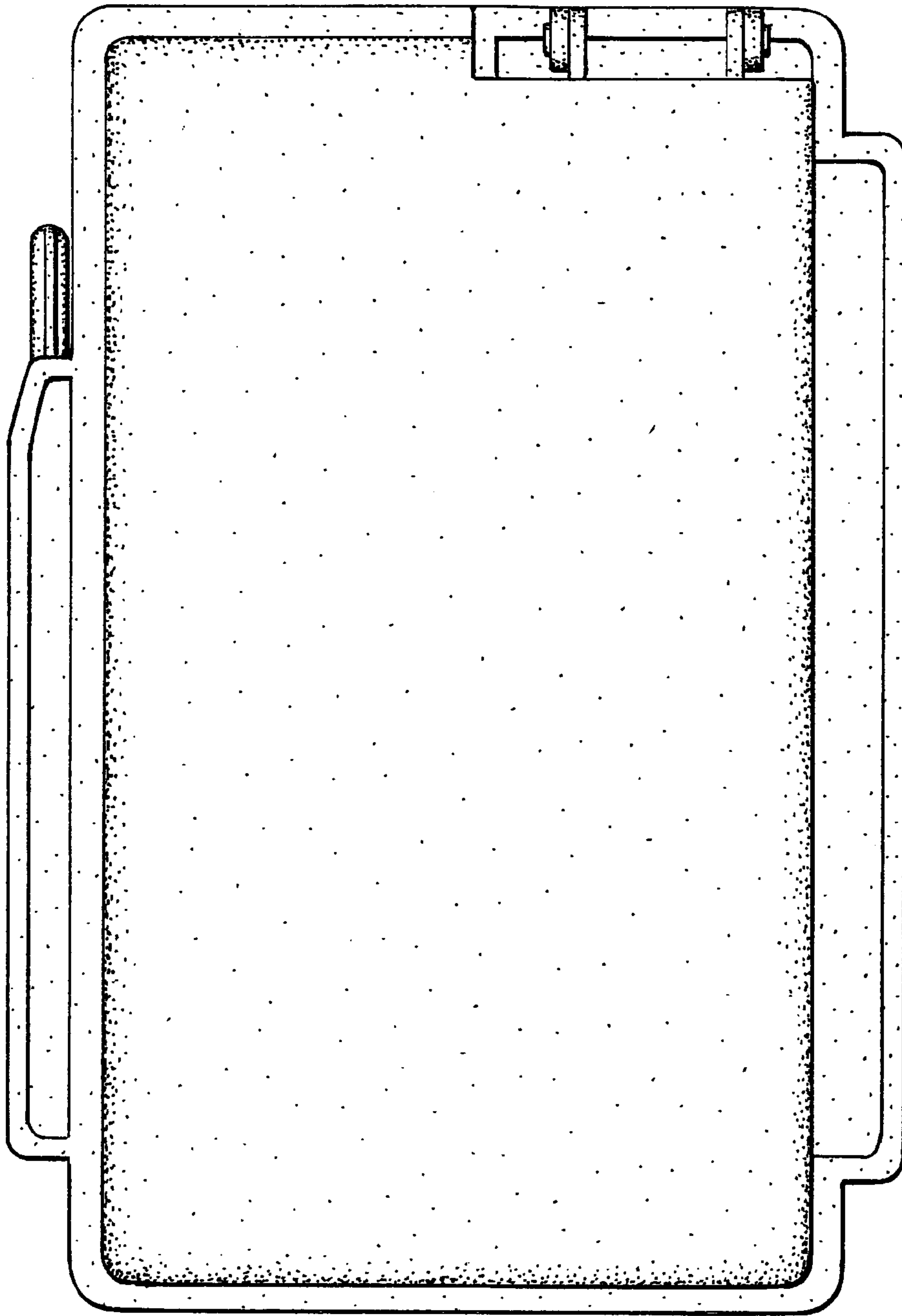

FIG. 7