



US00D535526S

(12) **United States Design Patent**
Krieger et al.

(10) **Patent No.:** **US D535,526 S**

(45) **Date of Patent:** **** Jan. 23, 2007**

(54) **TRAVEL COOLER AND WARMER BOTTOM PORTION**

D467,468 S * 12/2002 Krieger et al. D7/605
D480,274 S * 10/2003 Yuen D7/605
D480,275 S * 10/2003 Yuen D7/605

(75) Inventors: **Michael Krieger**, Miami Beach, FL (US); **Kevin Ellsworth**, Alva, FL (US)

* cited by examiner

(73) Assignee: **Vector Products, Inc.**, Fort Lauderdale, FL (US)

Primary Examiner—Terry A. Wallace

(74) *Attorney, Agent, or Firm*—Venable LLP; Robert Kinberg; Manni Li

(**) Term: **14 Years**

(57) **CLAIM**

(21) Appl. No.: **29/257,757**

The ornamental design for a travel cooler and warmer bottom portion, as shown and described.

(22) Filed: **Apr. 11, 2006**

DESCRIPTION

Related U.S. Application Data

(63) Continuation of application No. 29/228,837, filed on Apr. 29, 2005, now Pat. No. Des. 525,085, which is a continuation of application No. 29/228,838, filed on Apr. 29, 2005, now Pat. No. Des. 523,291, which is a continuation of application No. 29/228,839, filed on Apr. 29, 2005, now Pat. No. Des. 525,086.

FIG. 1 is a perspective view from the front-top-right side of the travel cooler and warmer bottom portion showing a first embodiment of our new design;

FIG. 2 is a front view of the design shown in FIG. 1;

FIG. 3 is a rear view of the design shown in FIG. 1;

FIG. 4 is a left side view of the design shown in FIG. 1;

FIG. 5 is a right side view of the design shown in FIG. 1;

FIG. 6 is a top view of the design shown in FIG. 1;

FIG. 7 is a bottom view of the design shown in FIG. 1;

FIG. 8 is a perspective view from the front-top-right side of the travel cooler and warmer bottom portion showing a second embodiment of our new design;

FIG. 9 is a front view of the design shown in FIG. 8;

FIG. 10 is a rear view of the design shown in FIG. 8;

FIG. 11 is a left side view of the design shown in FIG. 8;

FIG. 12 is a right side view of the design shown in FIG. 8;

FIG. 13 is a top view of the design shown in FIG. 8; and,

FIG. 14 is a bottom view of the design shown in FIG. 8.

The broken lines immediately adjacent the shaded areas represent the bounds of the claimed design while all other broken lines are for illustrative purposes only; the broken lines form no part of the claimed design.

(51) **LOC (8) Cl.** **07-01**

(52) **U.S. Cl.** **D7/605**

(58) **Field of Classification Search** D7/605–608, D7/709, 710; D15/81; 62/457.1–457.7, 371, 62/372, 3.62, 3.64; 220/592.16, 592.17, 592.2, 220/592.23–592.27, 915.1, 915.2; D12/423, D12/424

See application file for complete search history.

(56) **References Cited**

U.S. PATENT DOCUMENTS

4,274,262 A * 6/1981 Reed et al. 62/3.64
D400,053 S * 10/1998 Coffee et al. D7/605
D417,126 S * 11/1999 Arnfelt D7/605
D459,636 S * 7/2002 Krieger et al. D7/605
D462,878 S * 9/2002 Krieger D7/605
D463,717 S * 10/2002 Krieger D7/605

1 Claim, 14 Drawing Sheets

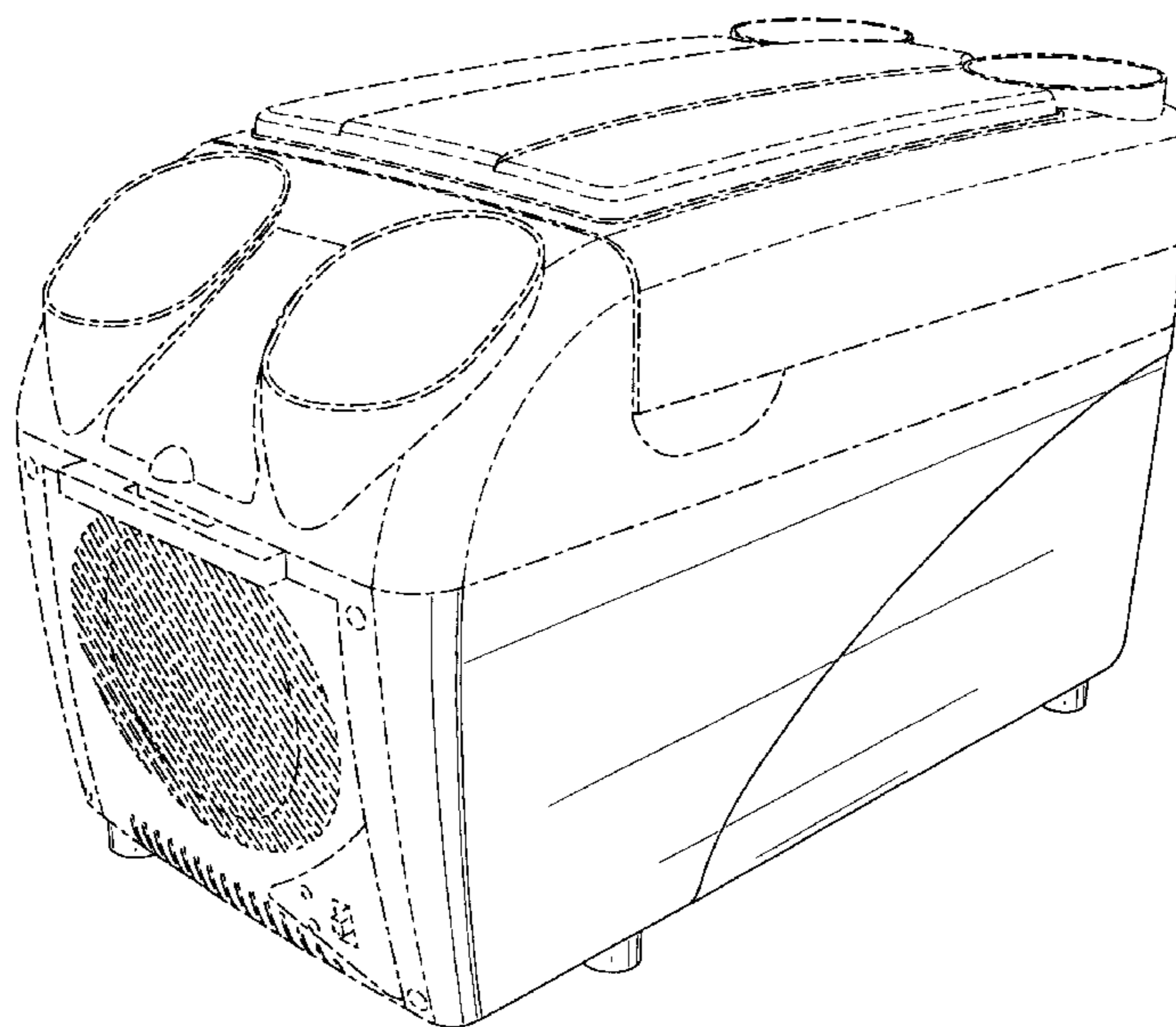

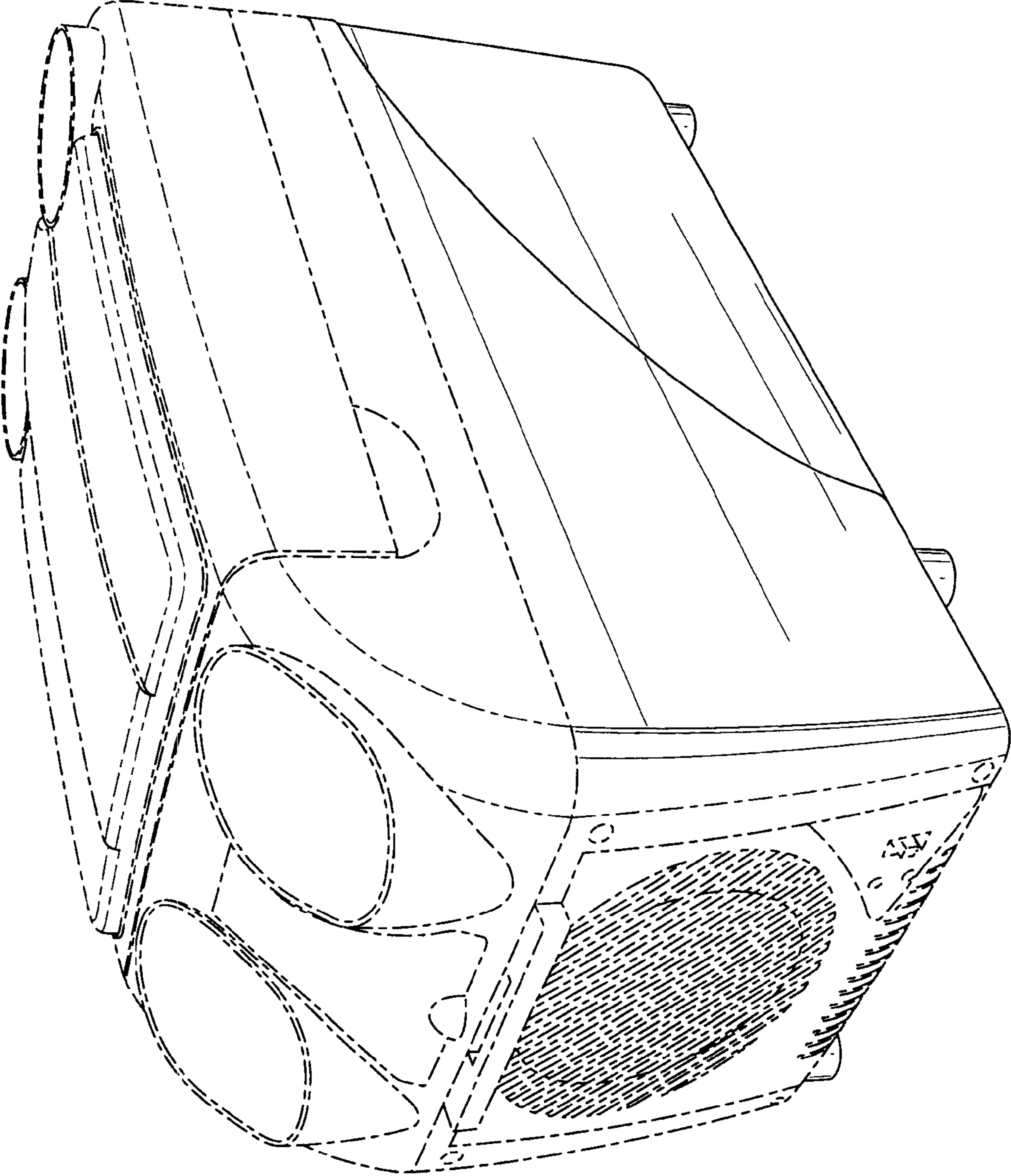

FIG. 1

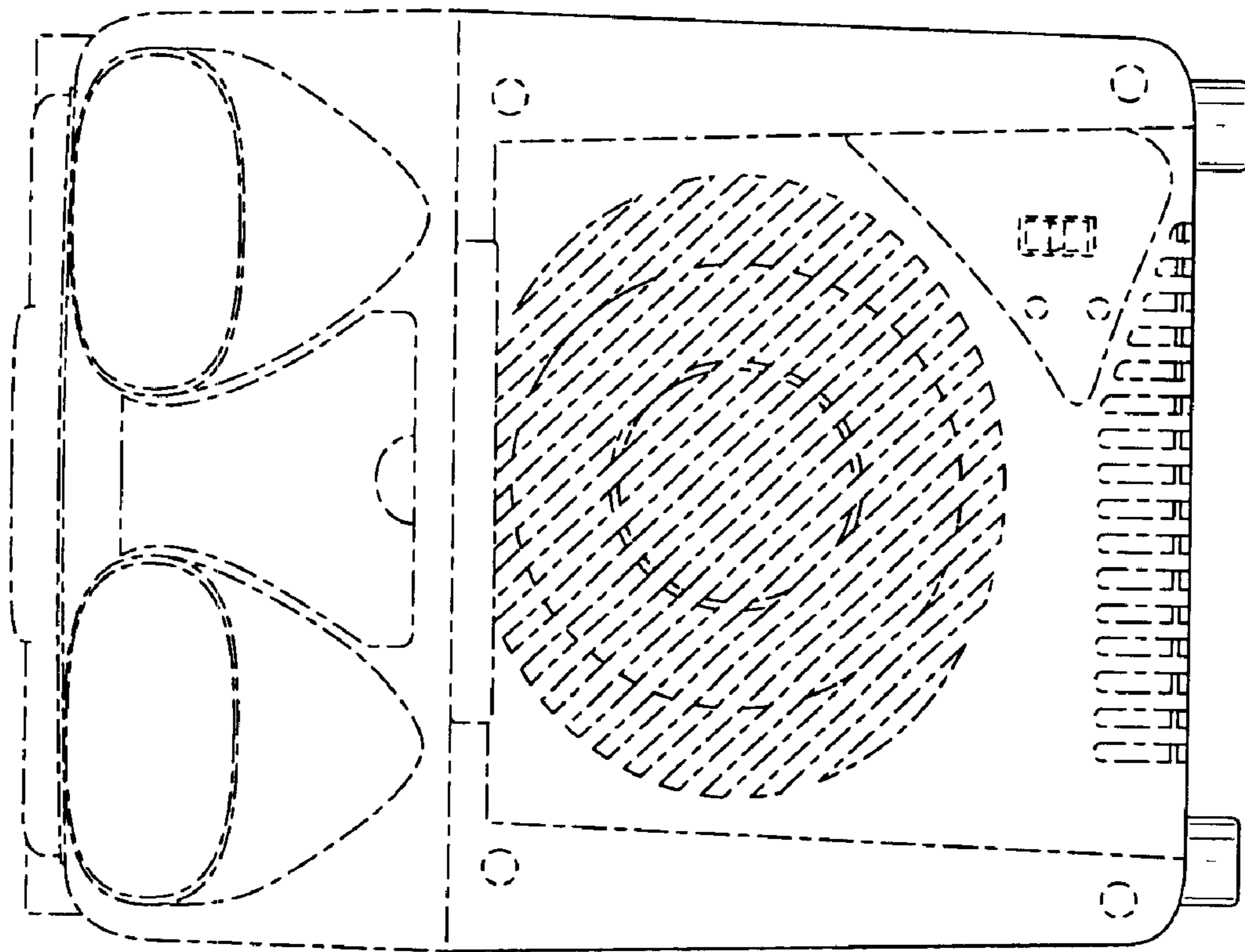

FIG. 2

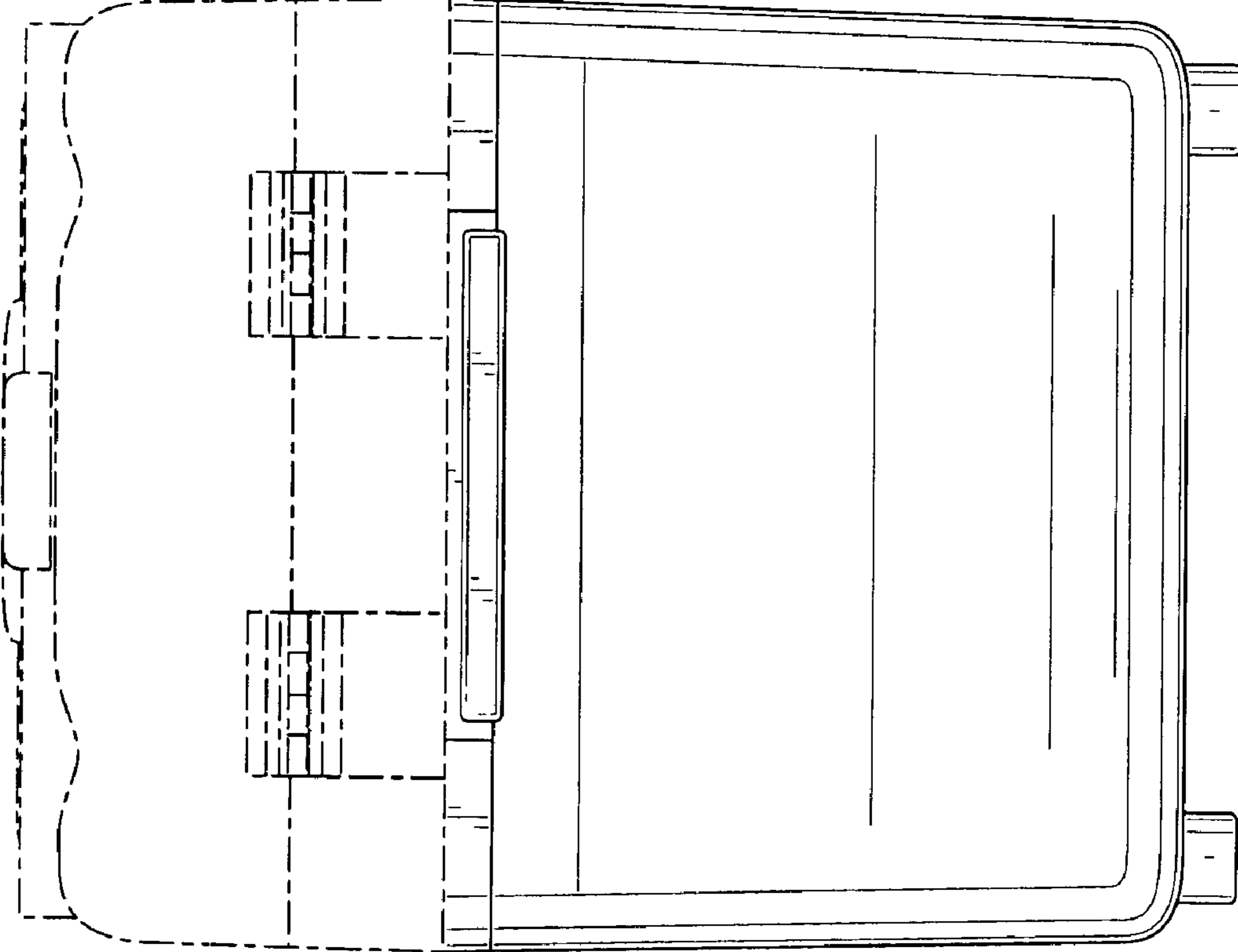

FIG. 3

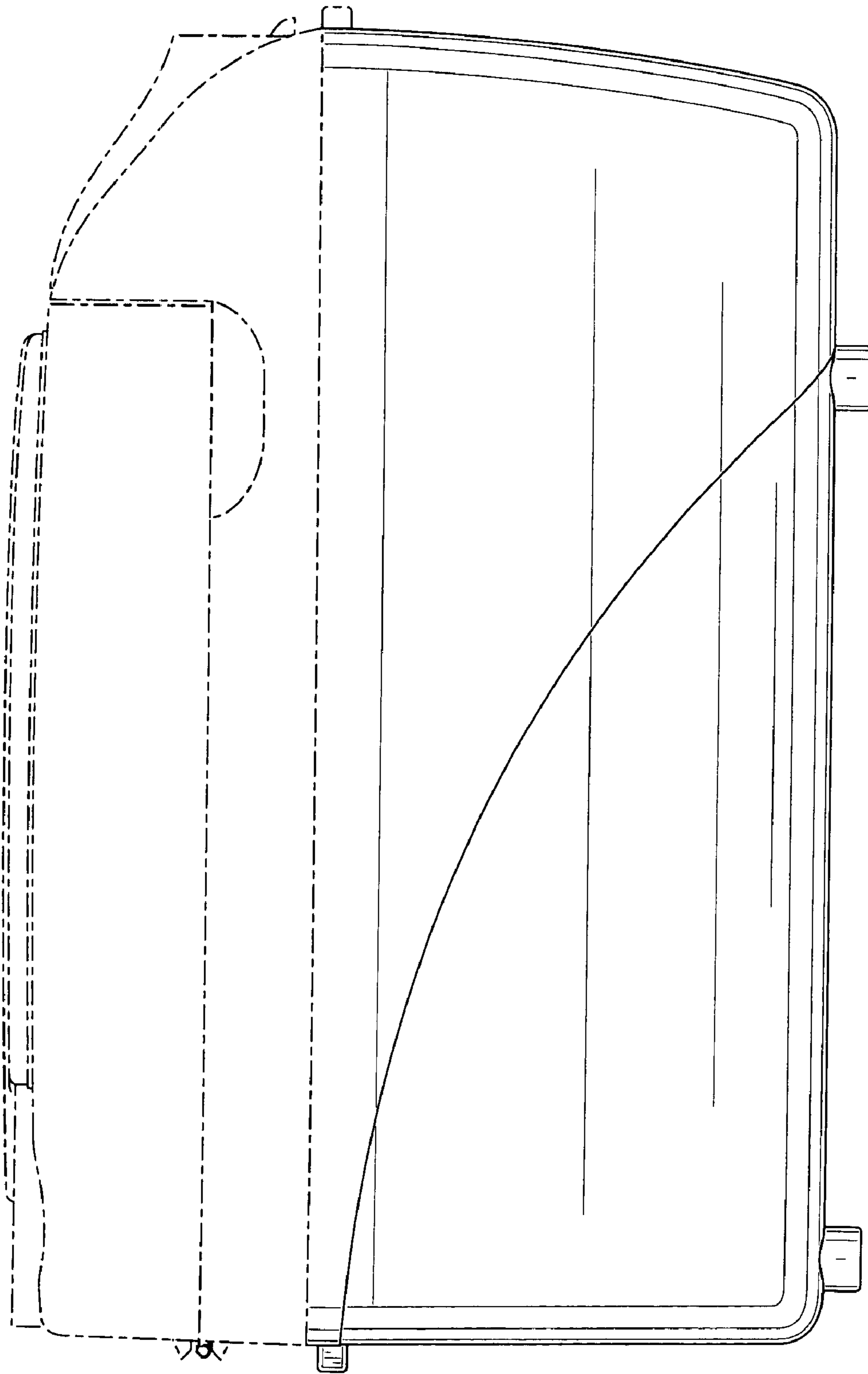

FIG. 4

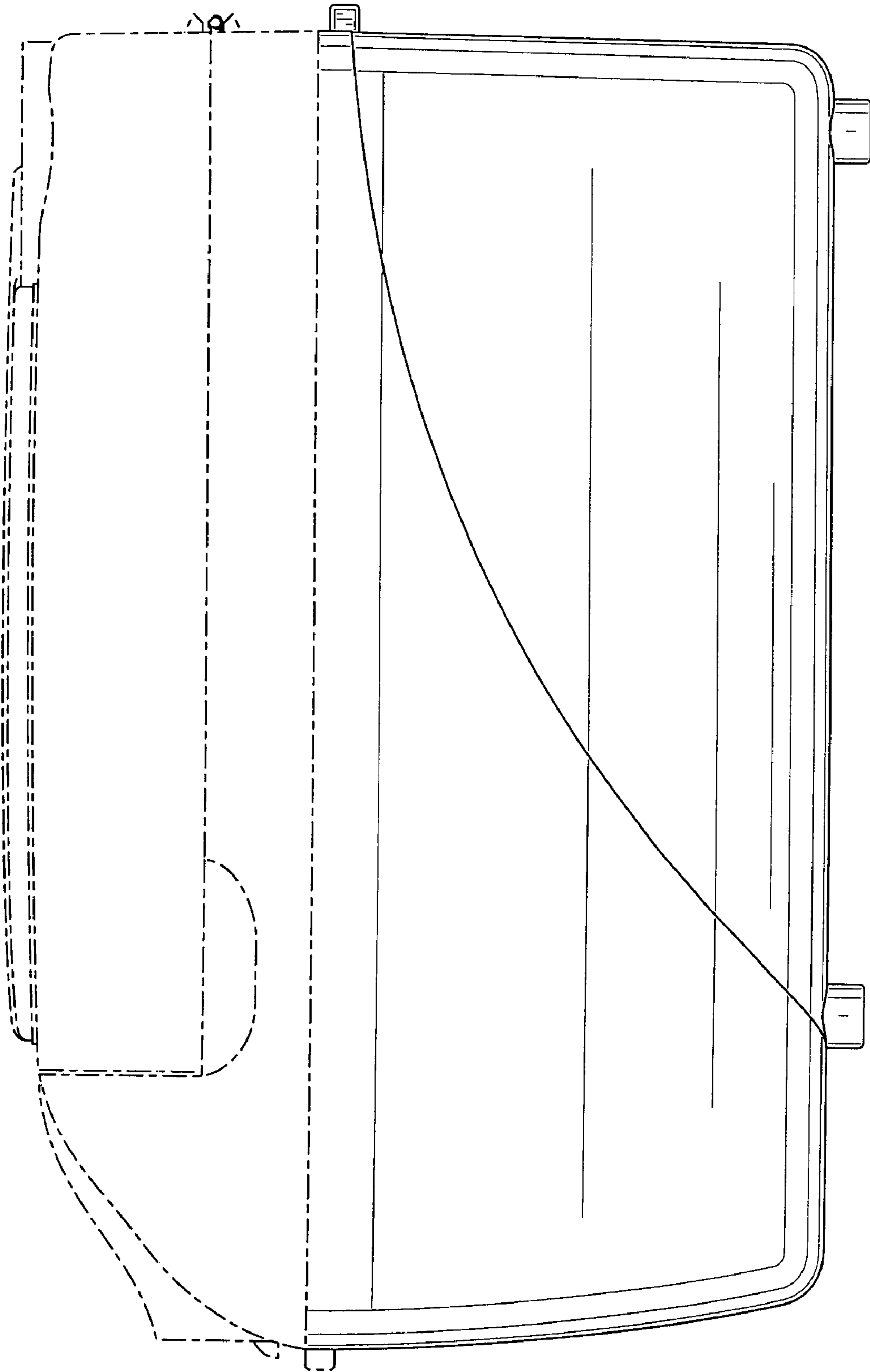

FIG. 5

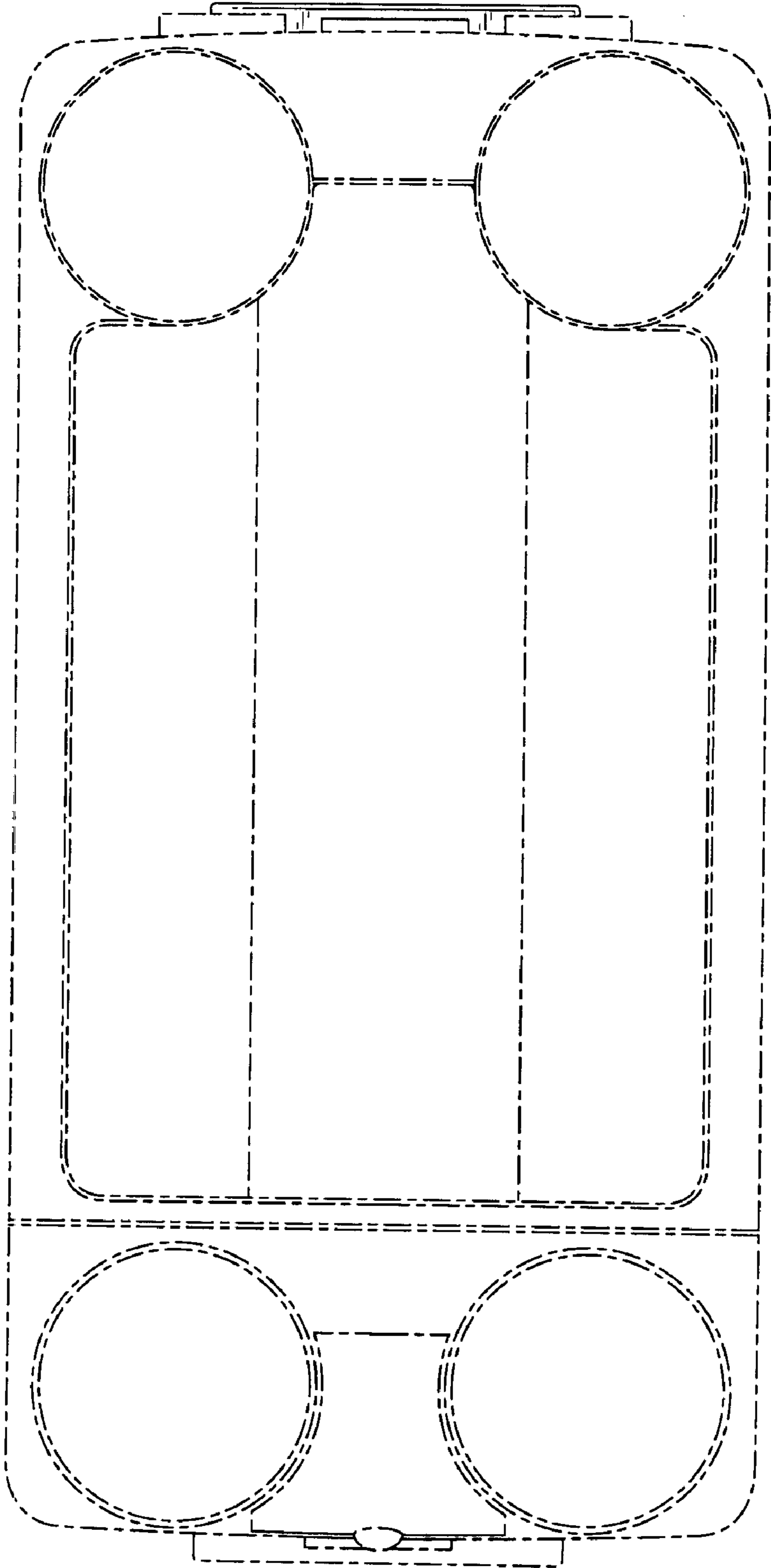

FIG. 6

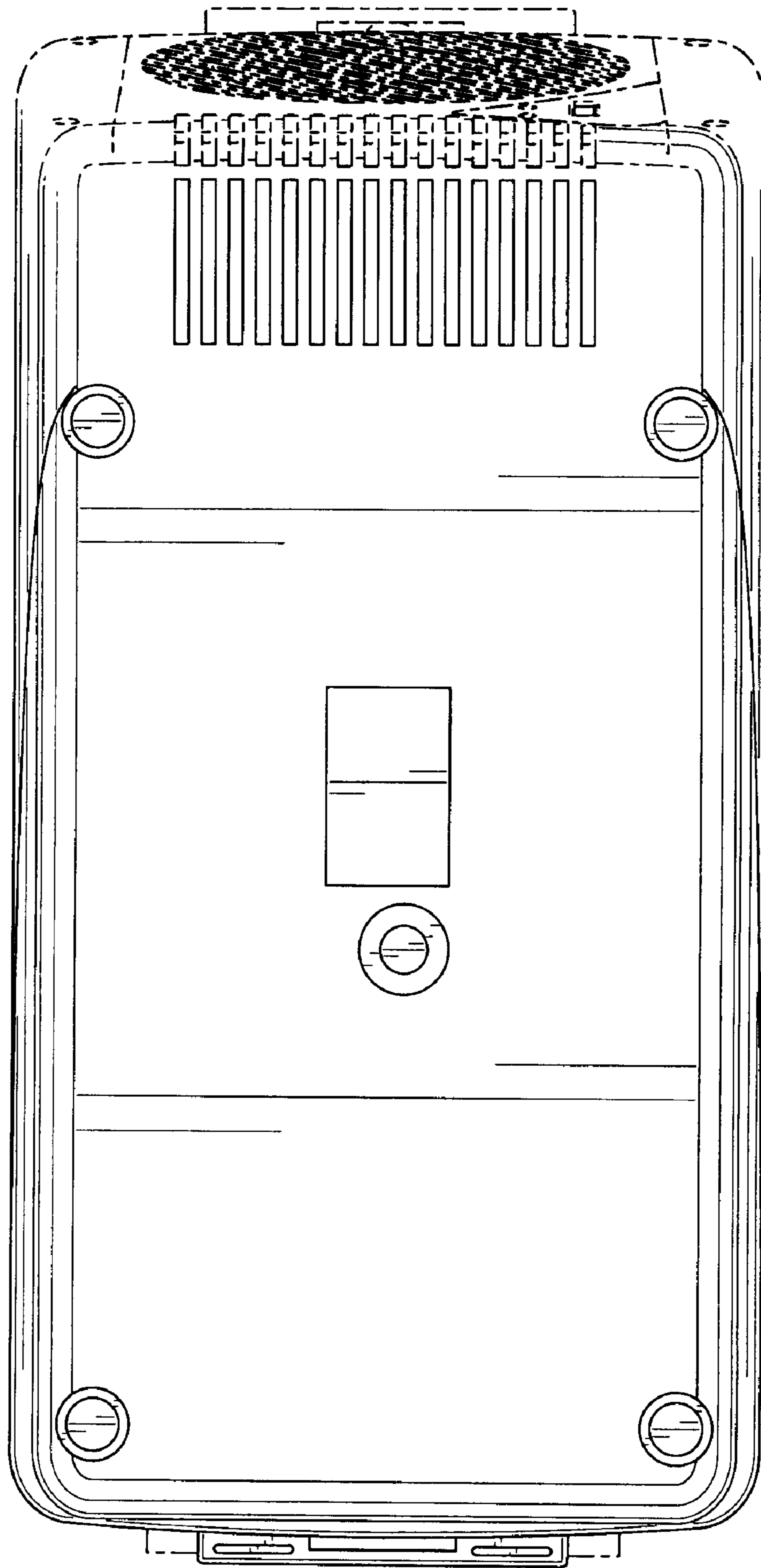

FIG. 7

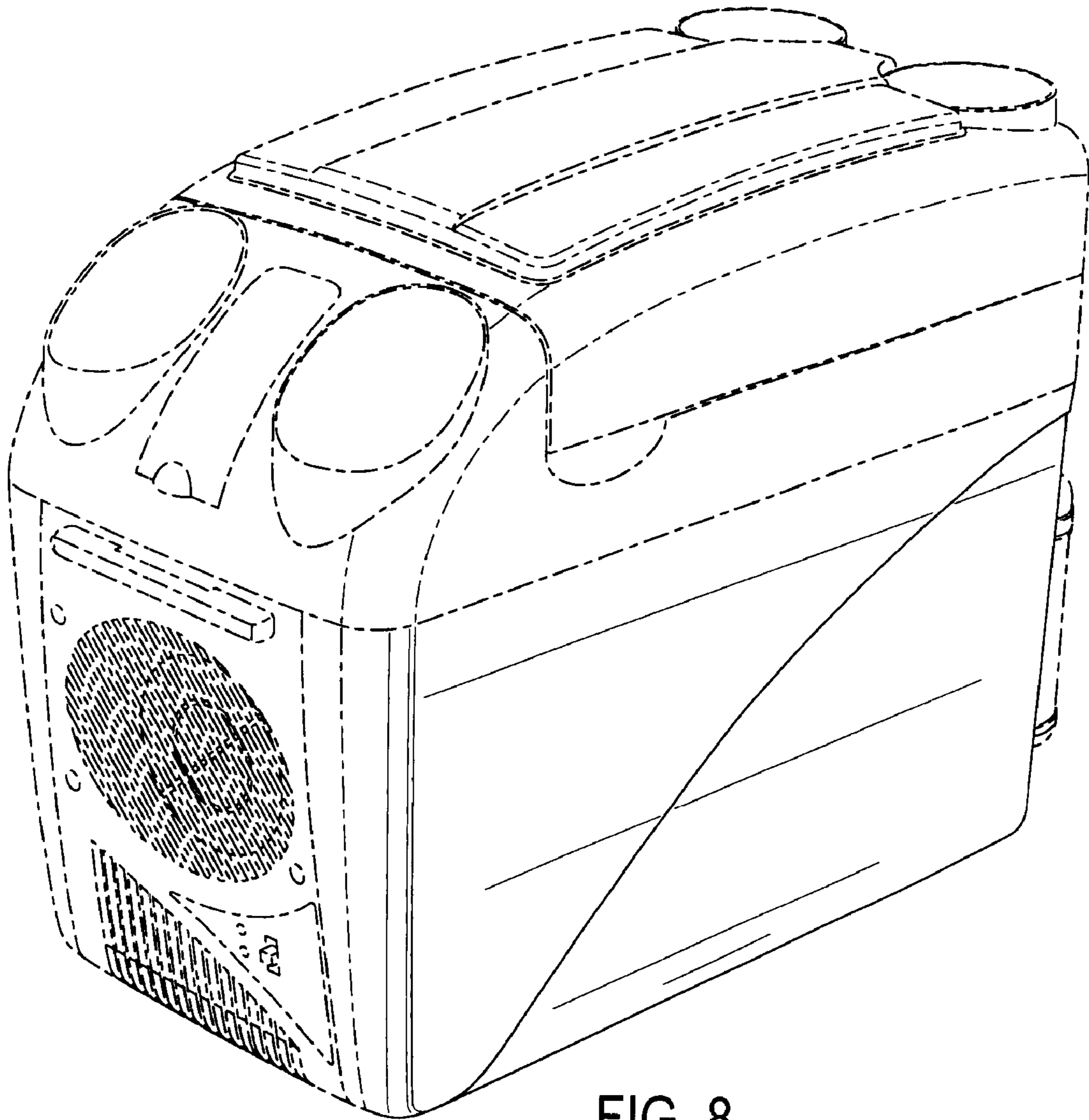

FIG. 8

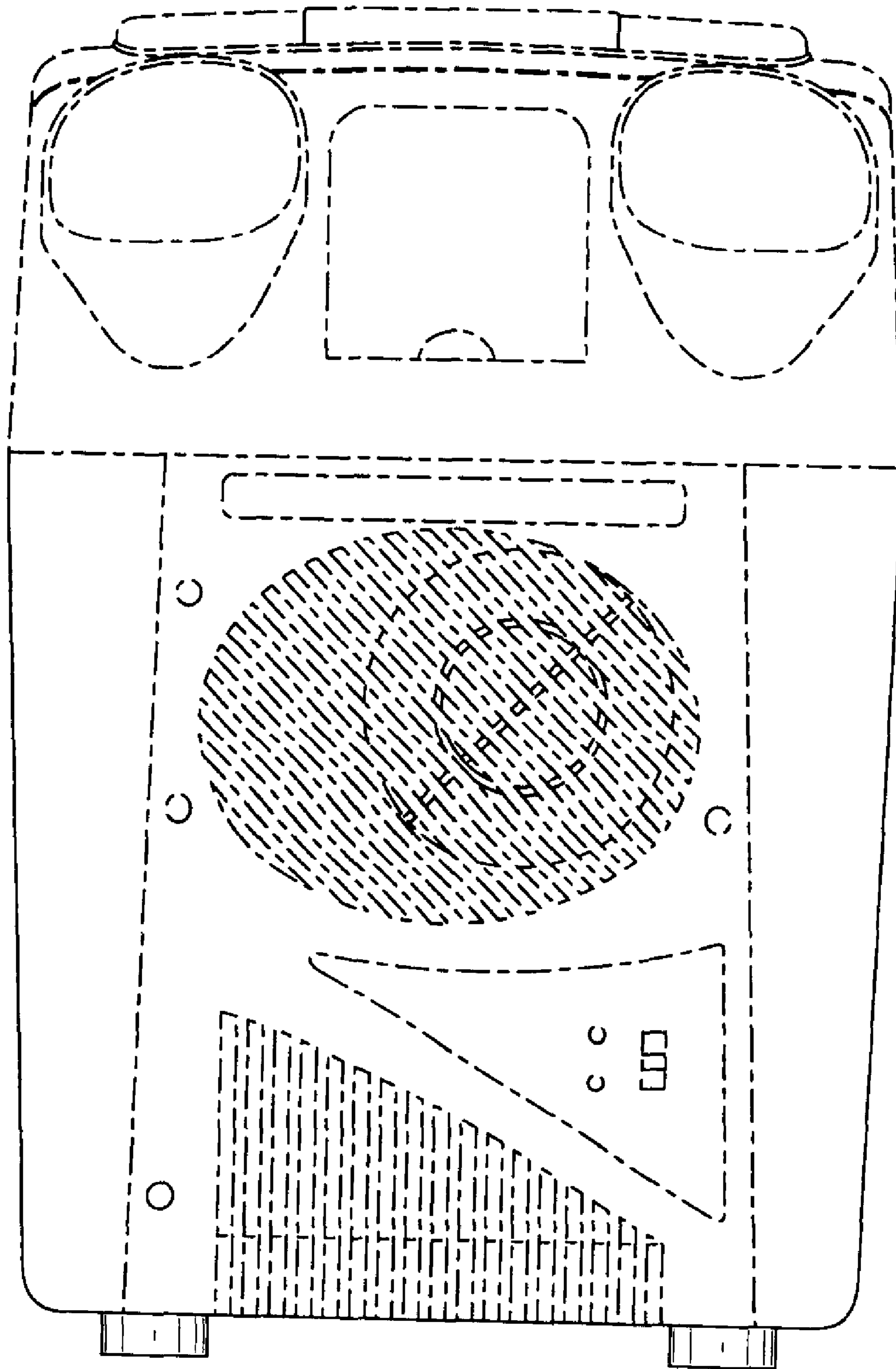

FIG. 9

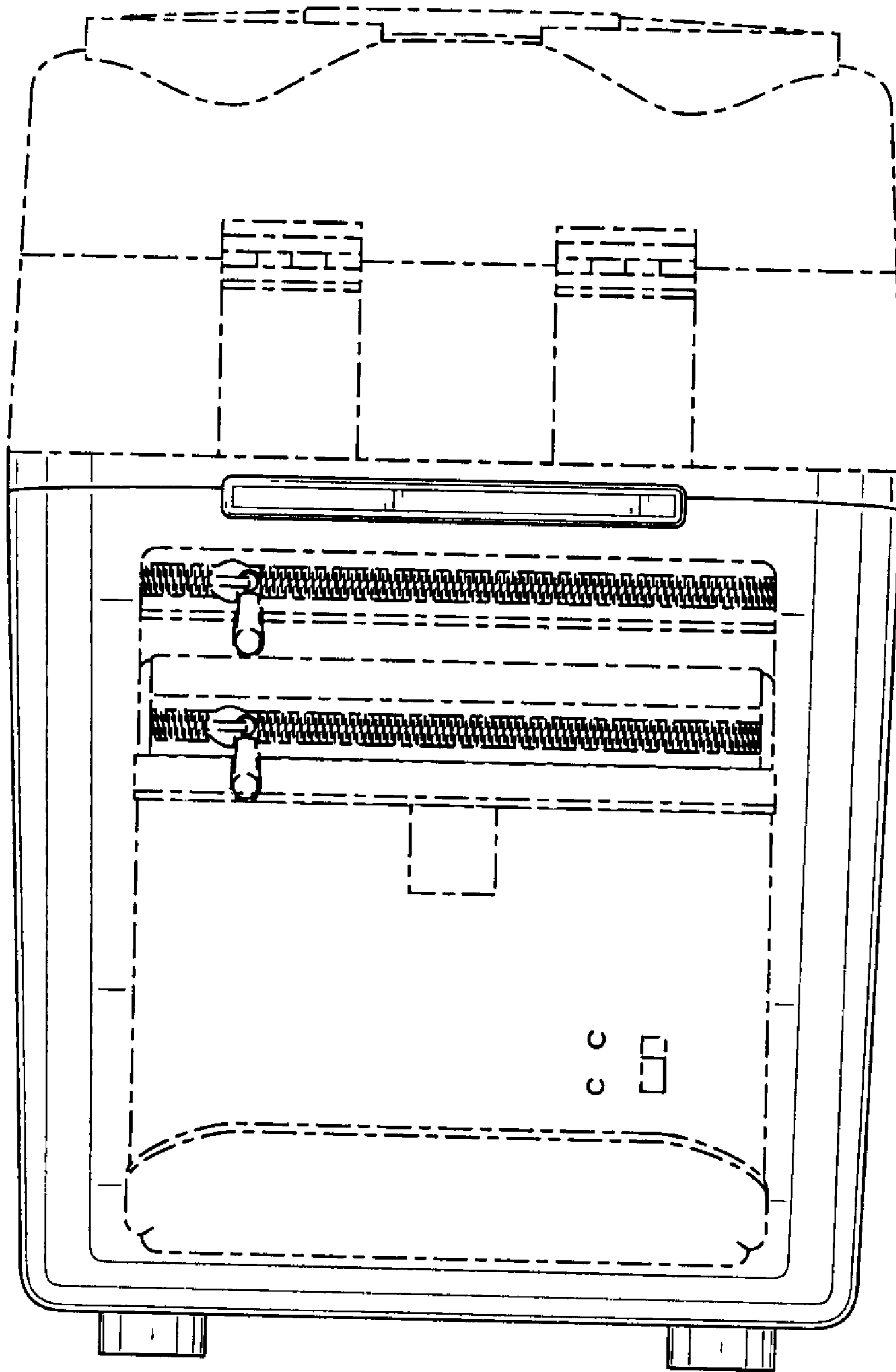

FIG. 10

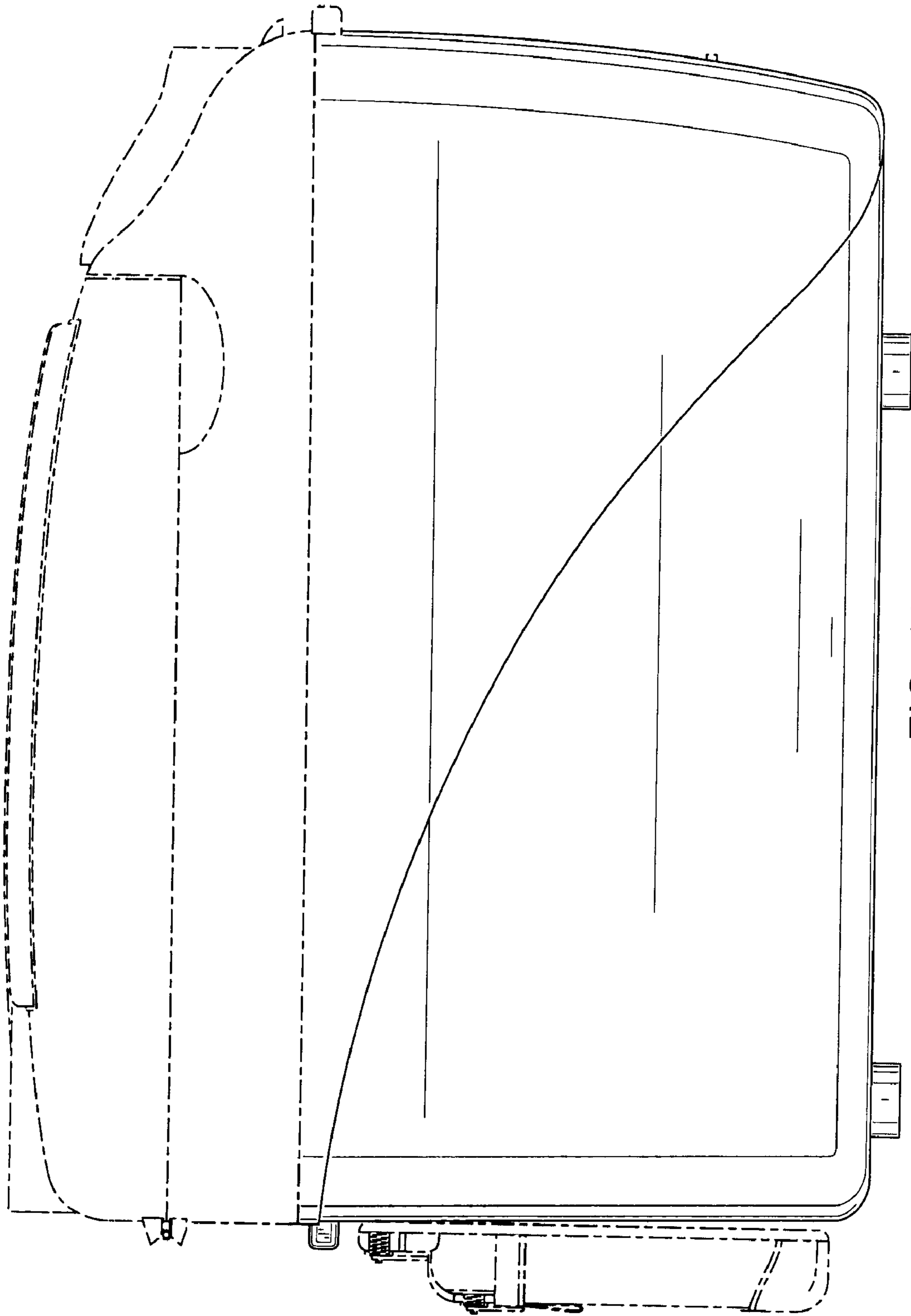

FIG. 11

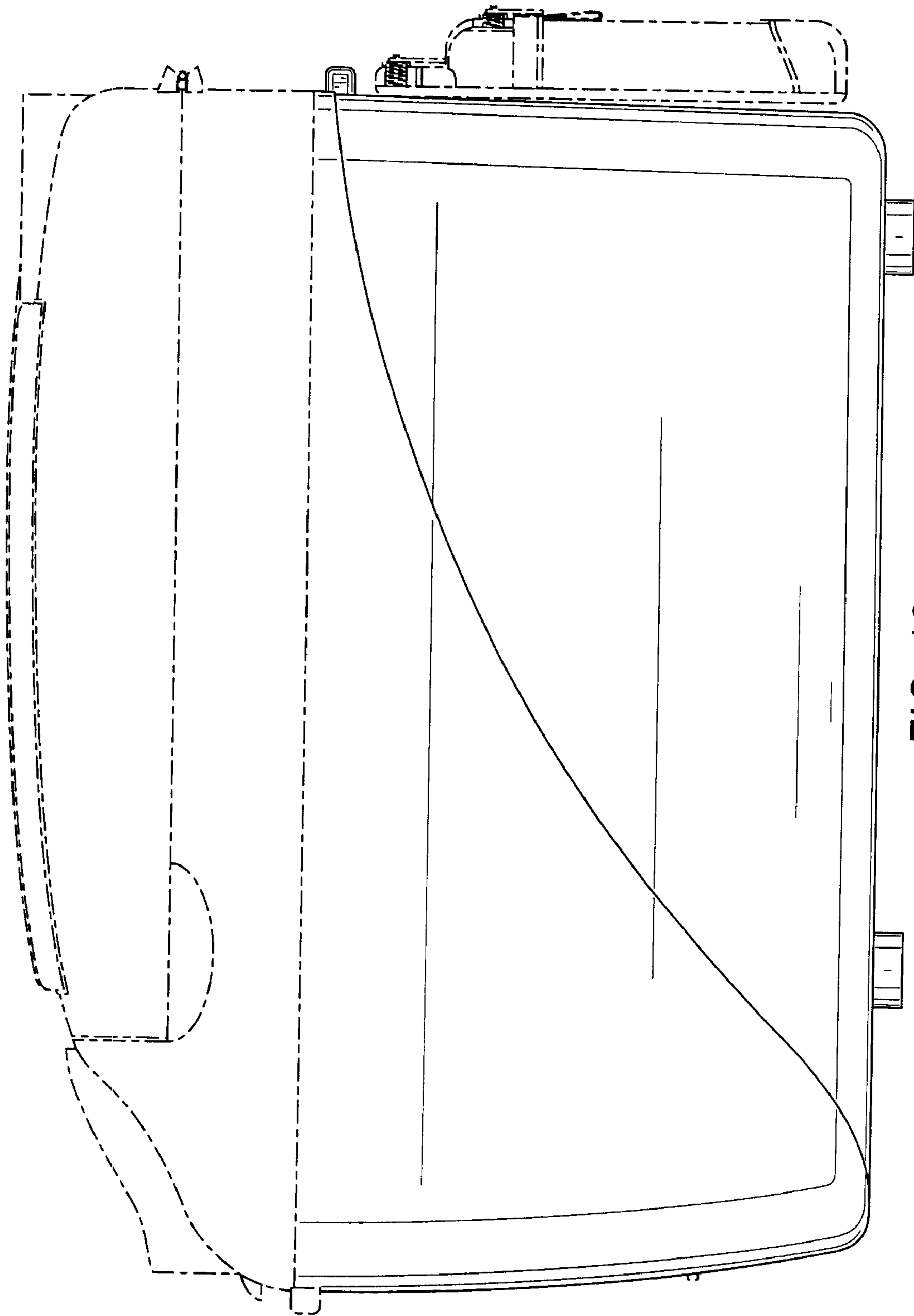

FIG. 12

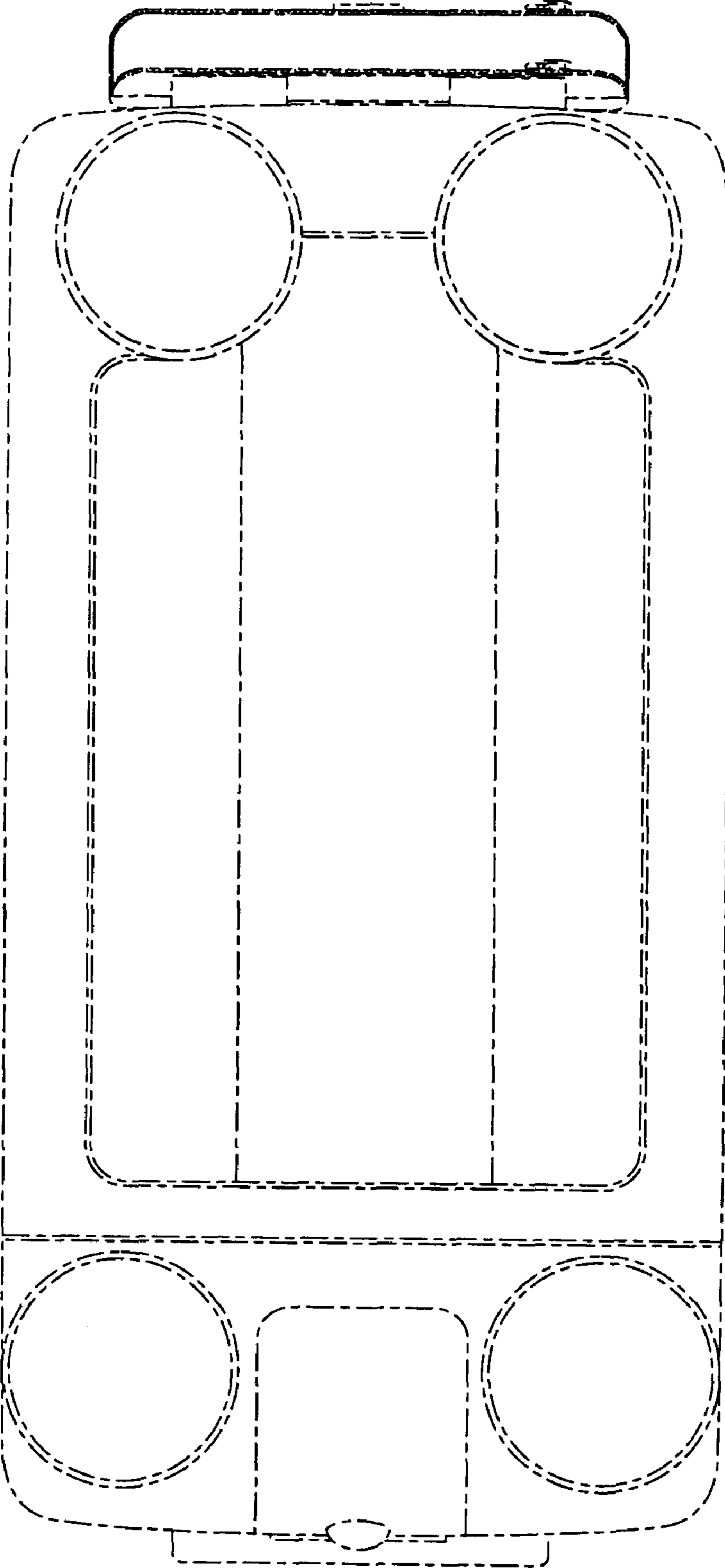

FIG. 13

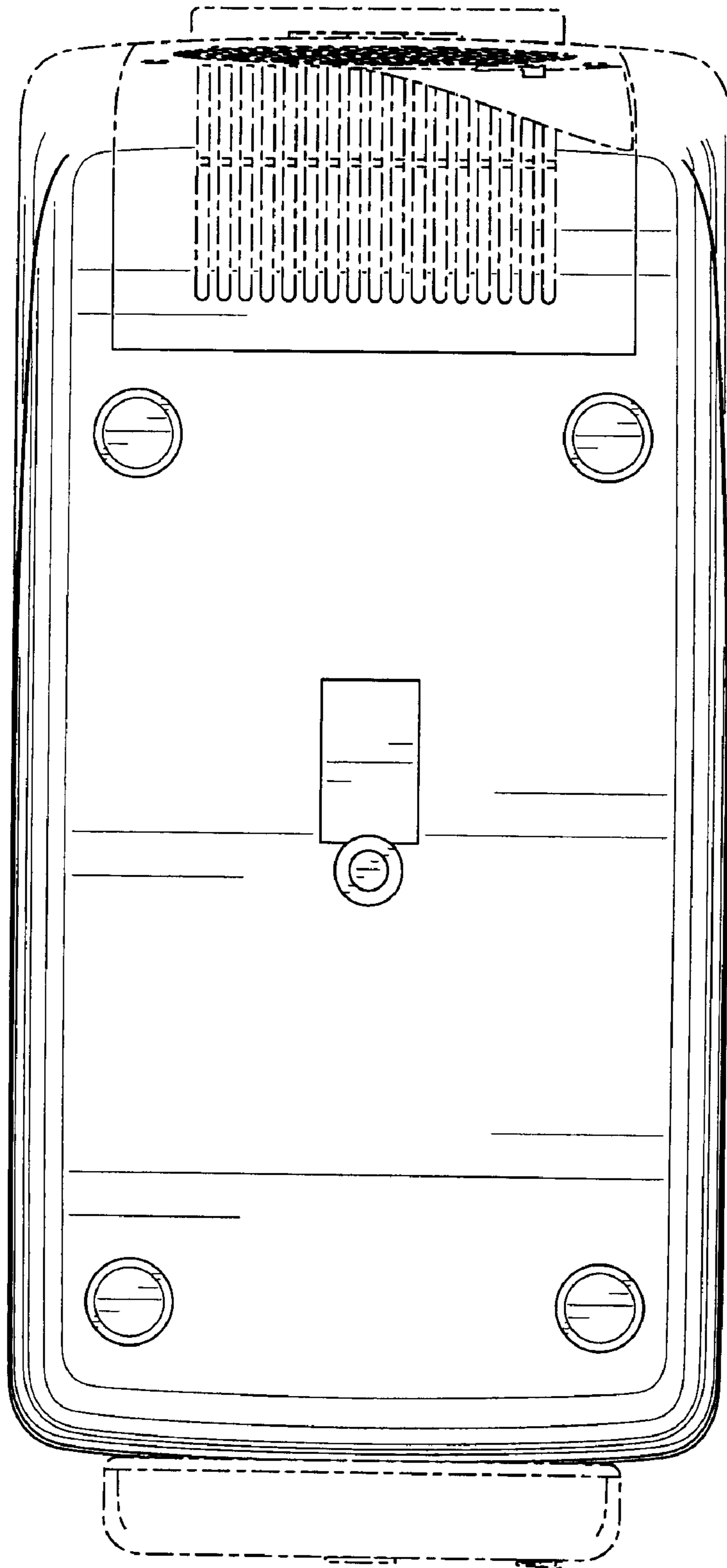

FIG. 14