



US00D535504S

(12) **United States Design Patent**  
**Egger**

(10) **Patent No.:** **US D535,504 S**

(45) **Date of Patent:** **\*\* Jan. 23, 2007**

(54) **CHAIR ARM**

(75) Inventor: **Julien Egger**, Santa Monica, CA (US)

(73) Assignee: **True Seating Concepts, LLC** (MU)

(\*\*) Term: **14 Years**

(21) Appl. No.: **29/222,215**

(22) Filed: **Jan. 28, 2005**

(51) **LOC (8) Cl.** ..... **06-06**

(52) **U.S. Cl.** ..... **D6/501; D6/366**

(58) **Field of Classification Search** ..... D6/334-335,  
D6/364, 365, 366, 367, 368, 374, 500-502;  
297/411.2, 411.27, 411.28, 463.1  
See application file for complete search history.

(56) **References Cited**

**U.S. PATENT DOCUMENTS**

D436,770 S	*	1/2001	Schultz	.....	D6/366
D446,061 S	*	8/2001	Su	.....	D6/501
D474,051 S	*	5/2003	Tseng	.....	D6/500
D482,219 S	*	11/2003	Grove	.....	D6/501
D487,657 S	*	3/2004	Chen	.....	D6/501
D488,009 S	*	4/2004	Chi	.....	D6/501

\* cited by examiner

*Primary Examiner*—Mimosa De

(74) *Attorney, Agent, or Firm*—Morland C. Fischer

(57) **CLAIM**

The ornamental design for a chair arm, as shown and described.

**DESCRIPTION**

FIG. 1 is a perspective view showing the top, right side and front of a chair arm having an associated arm pad which forms my new design, the broken lines being for illustrative purposes only and forming no part of my design;

FIG. 2 is an enlarged perspective view showing the top, right side and front of my chair arm having an associated arm pad;

FIG. 3 is a top plan view thereof;

FIG. 4 is a bottom plan view thereof;

FIG. 5 is a right side elevational view thereof;

FIG. 6 is a left side elevational view thereof;

FIG. 7 is a rear elevational view thereof;

FIG. 8 is a front elevational view thereof;

FIG. 9 is a perspective view showing the top, right side and front of my chair arm without an associated arm pad for easy of illustration;

FIG. 10 is a top plan view thereof;

FIG. 11 is a bottom plan view thereof;

FIG. 12 is a right side elevational view thereof;

FIG. 13 is a left side elevational view thereof;

FIG. 14 is a rear side elevational view thereof; and,

FIG. 15 is a front elevational view thereof.

The short, broken lines on the arm pad for the chair arm shown in FIGS. 1-3 and 5-8 are understood to represent stitching.

**1 Claim, 7 Drawing Sheets**

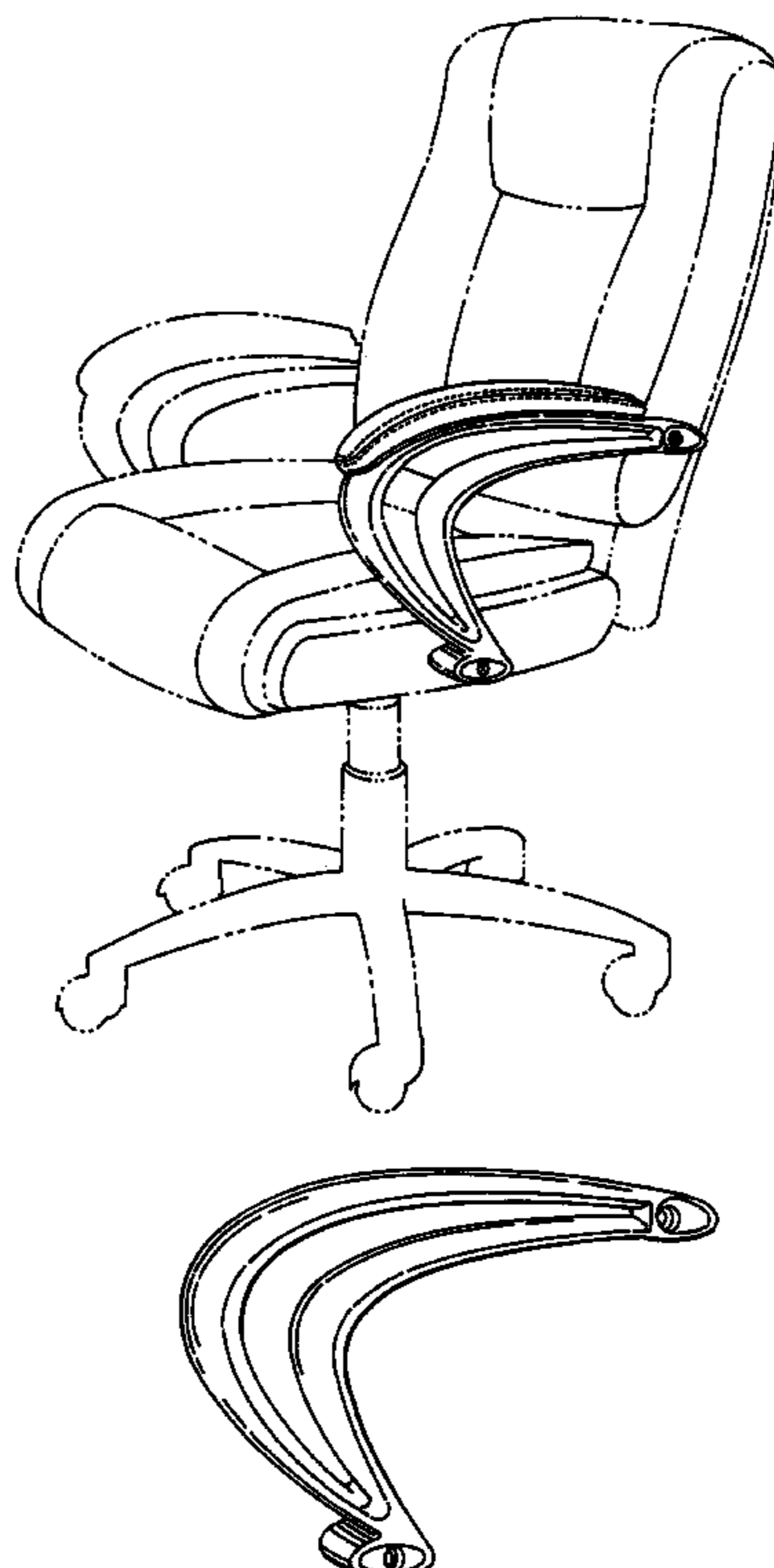

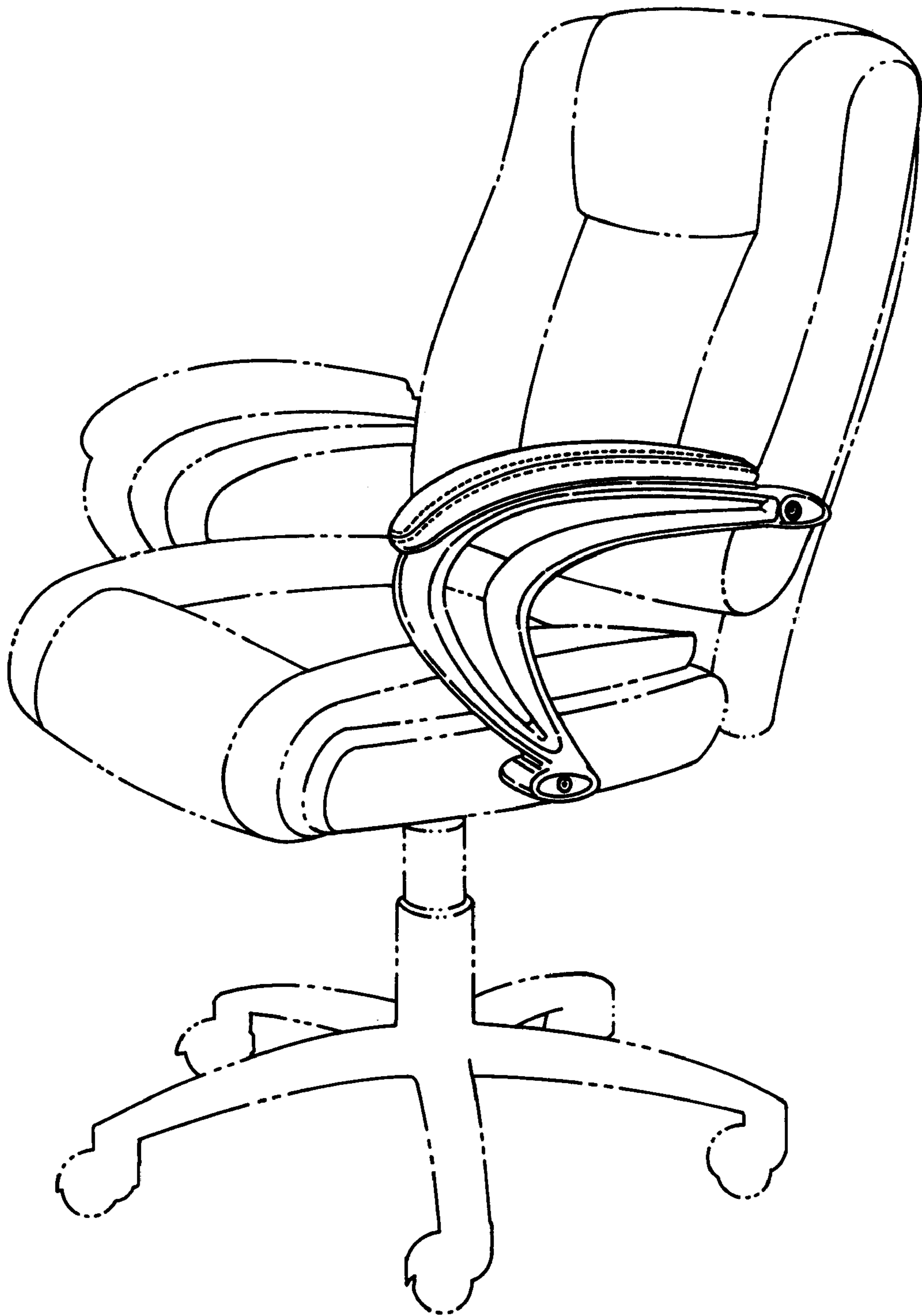

FIG. 1

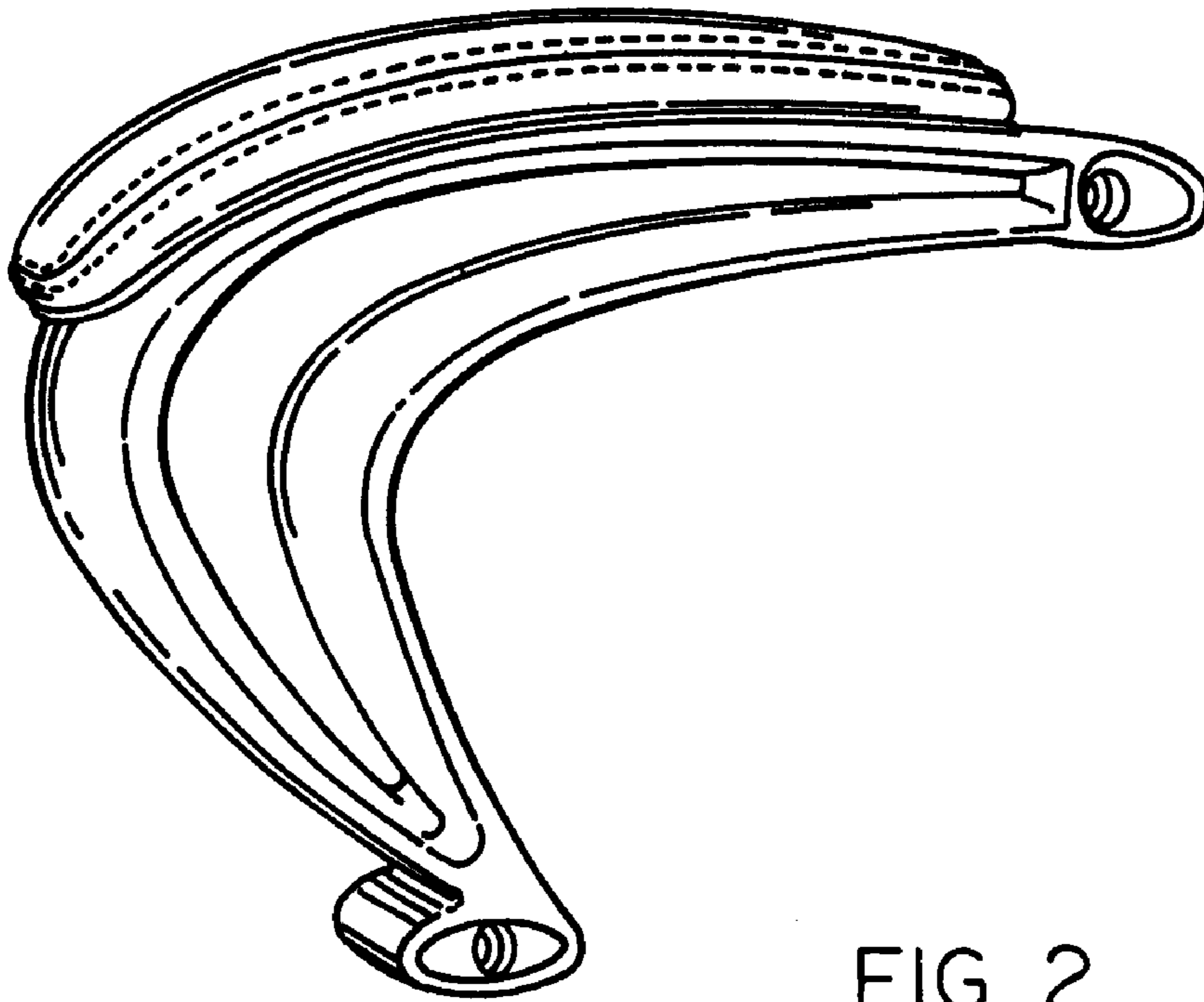

FIG. 2

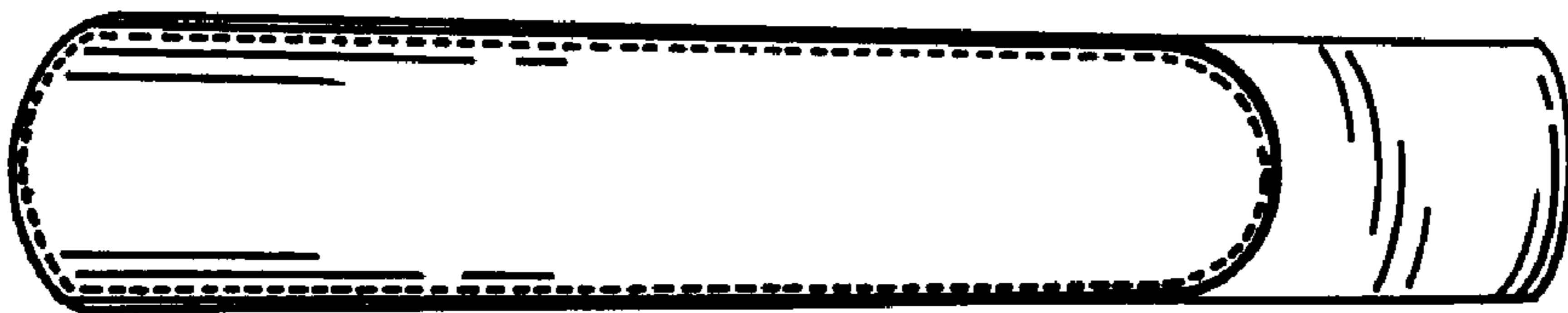

FIG. 3

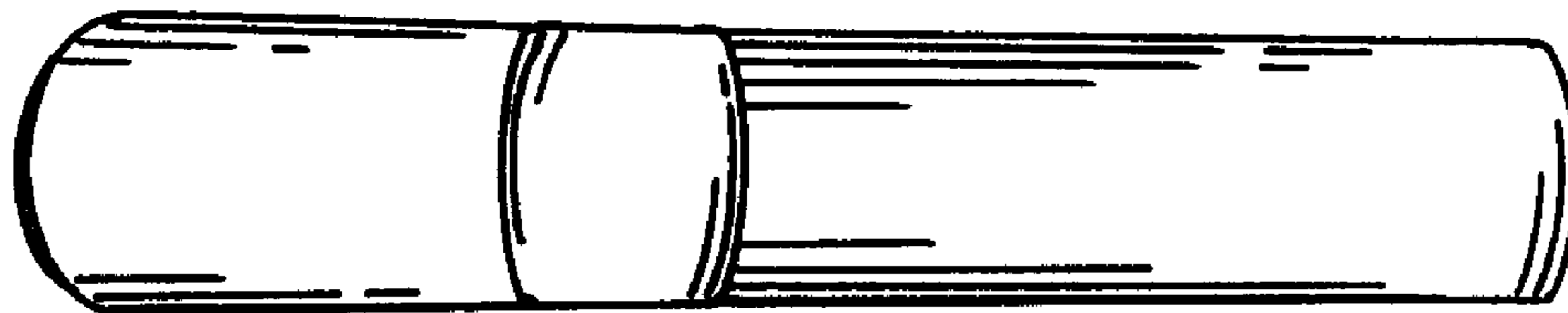

FIG. 4

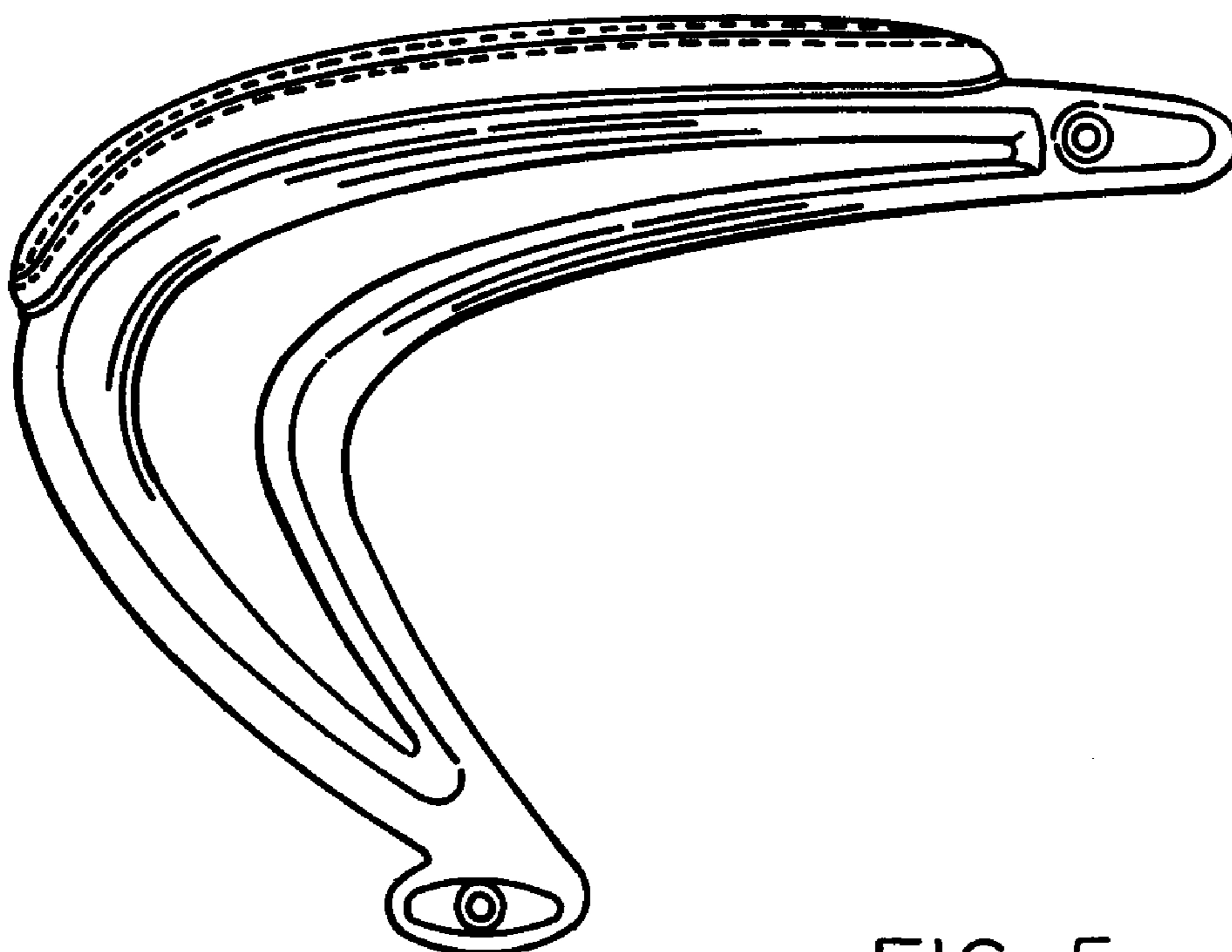

FIG. 5

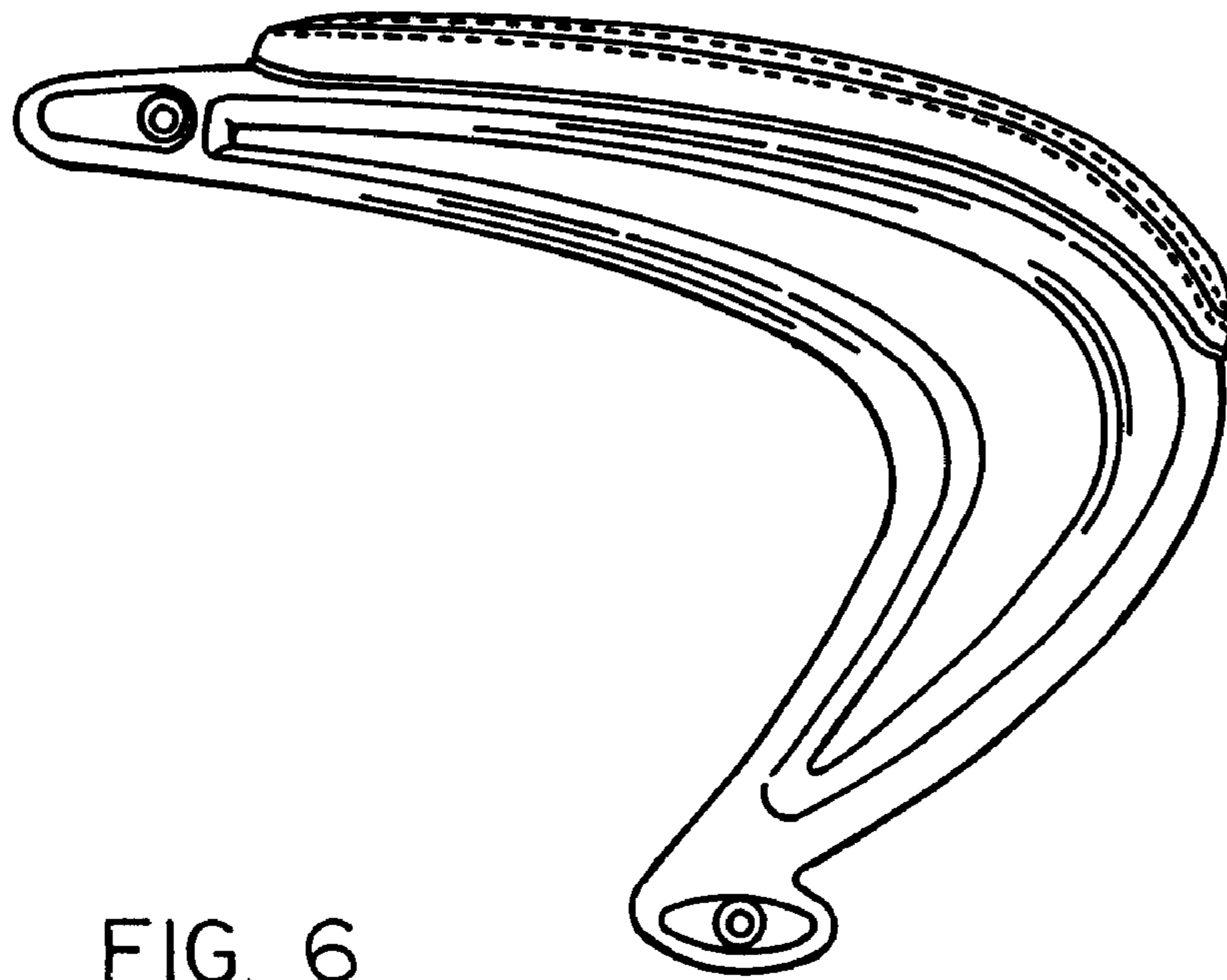

FIG. 6

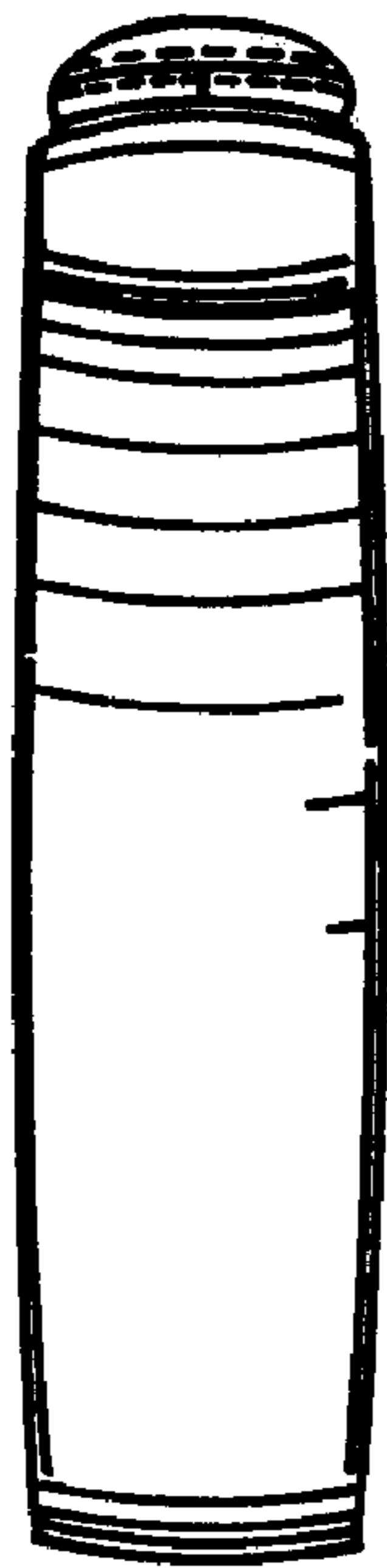

FIG. 7



FIG. 8

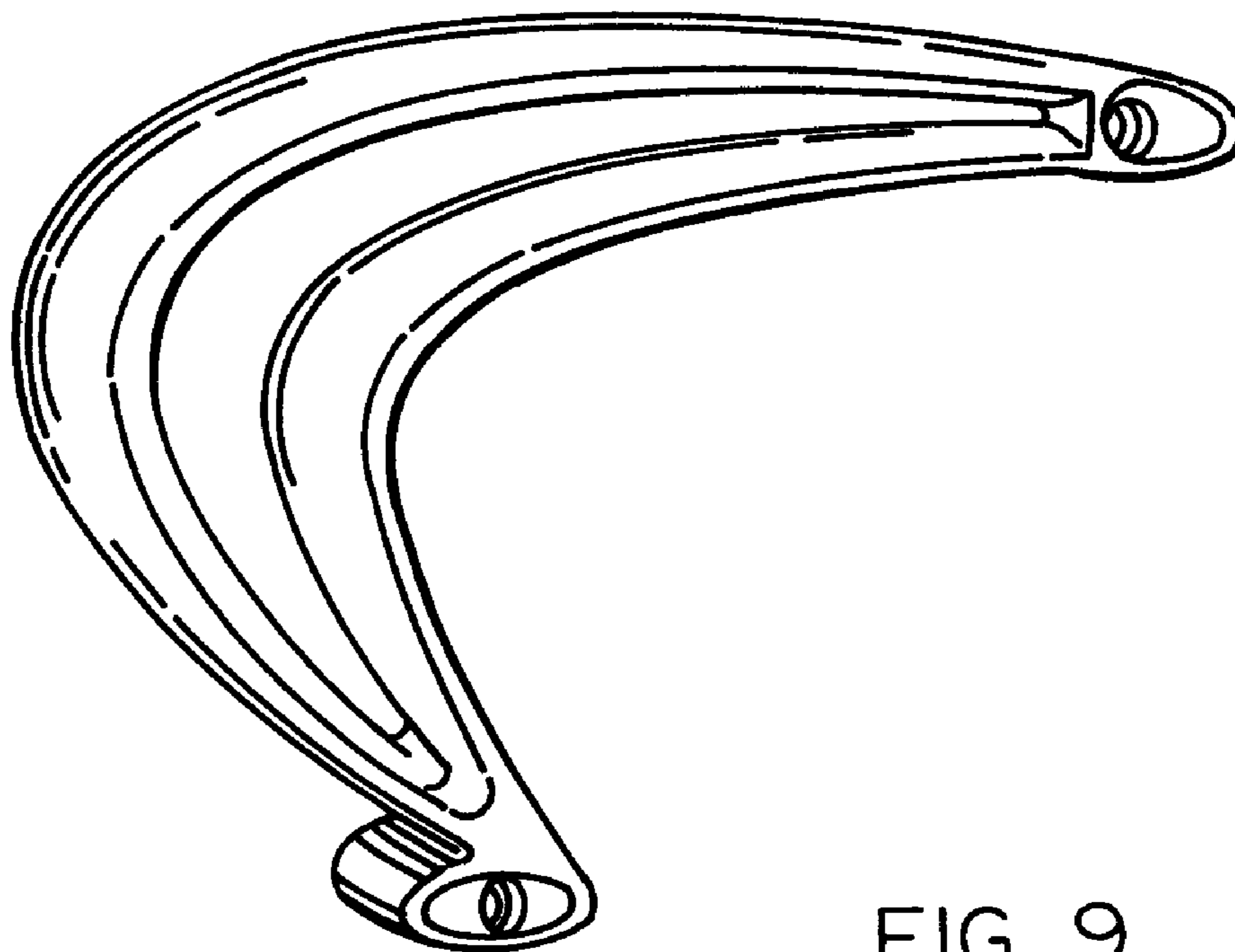

FIG. 9

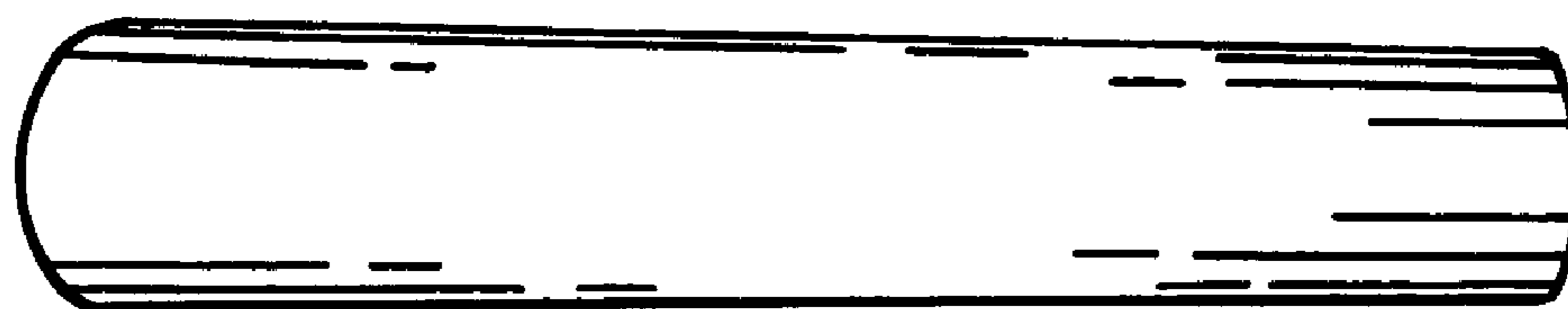

FIG. 10



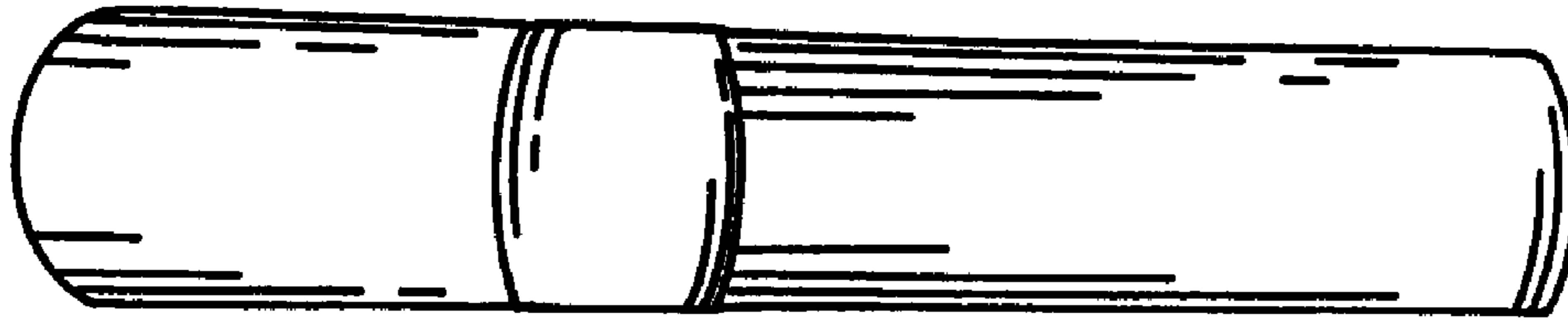

FIG. 11

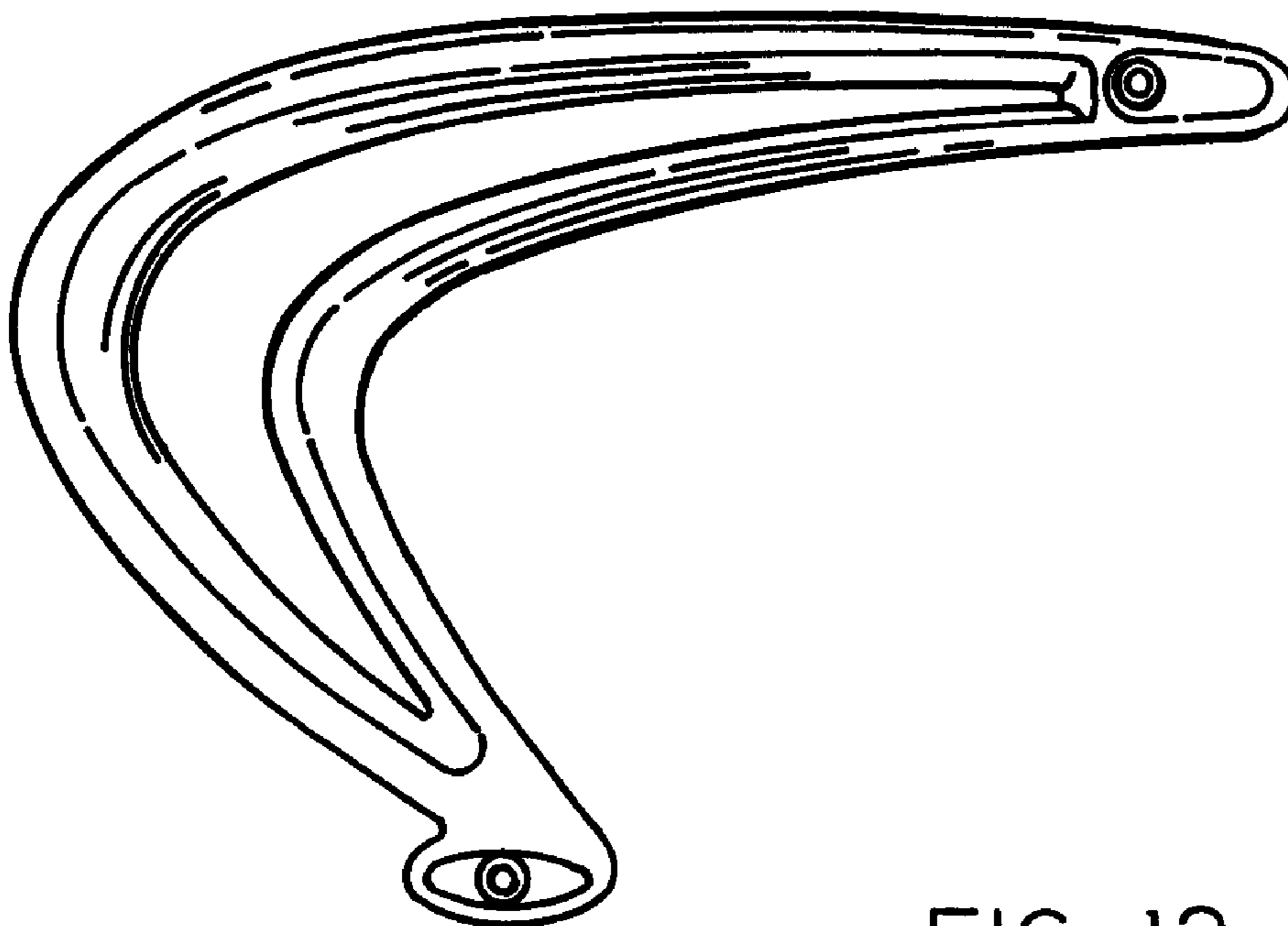

FIG. 12

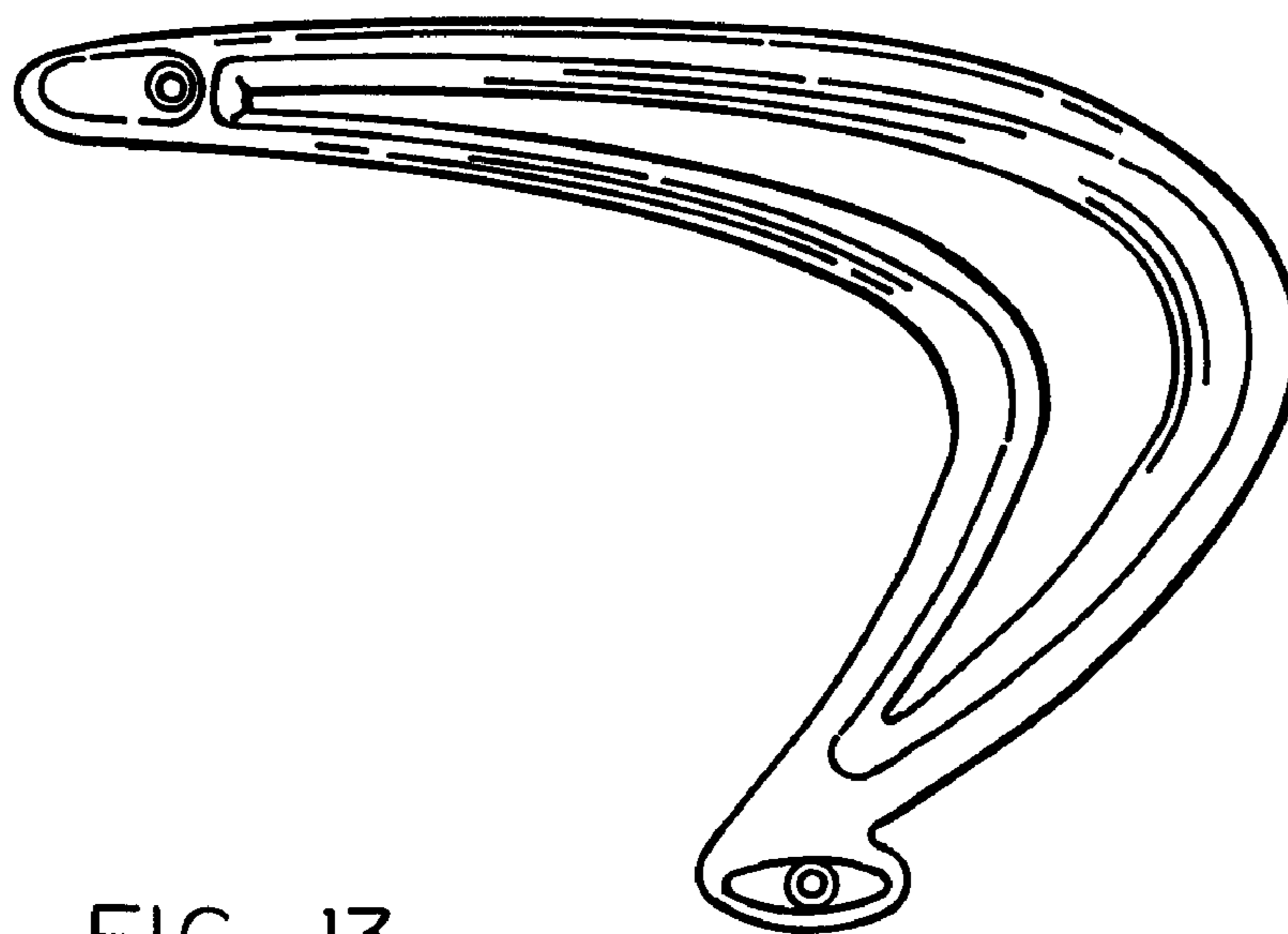

FIG. 13

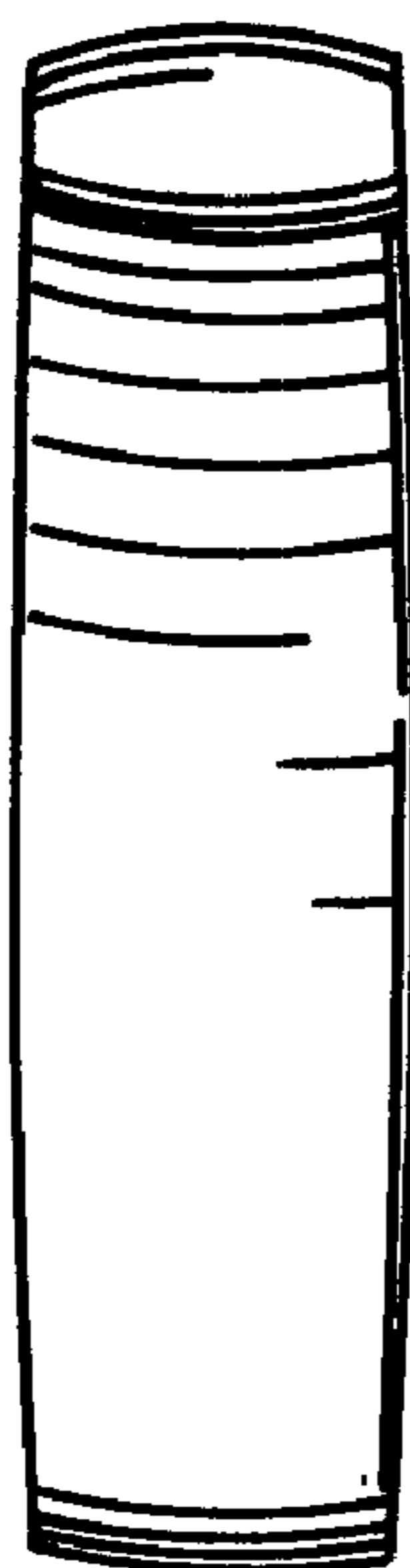

FIG. 14

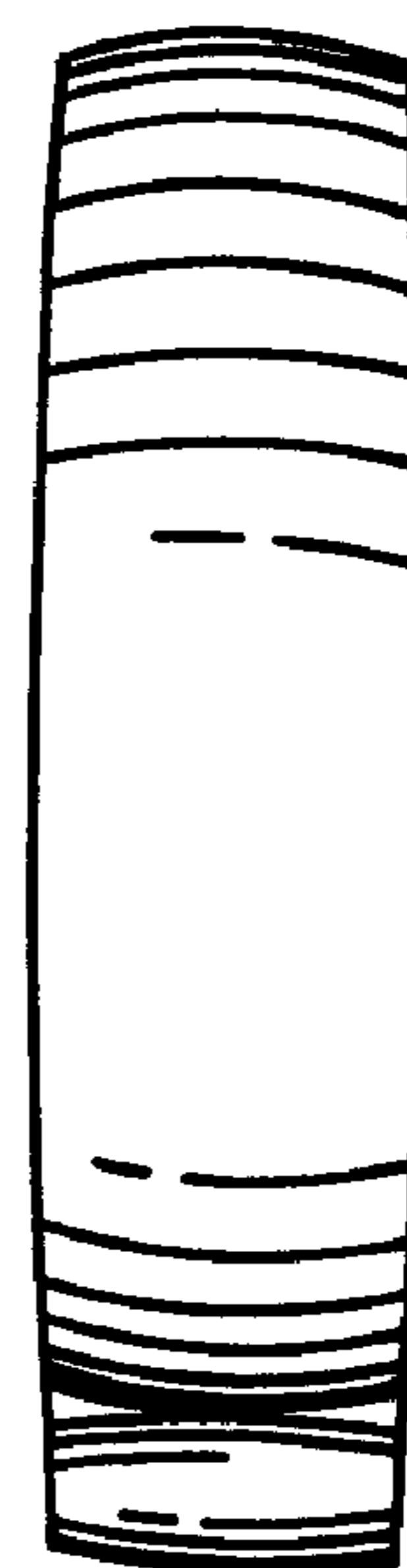

FIG. 15