



US00D535447S

(12) **United States Design Patent**  
**Olivetti**

(10) **Patent No.:** **US D535,447 S**

(45) **Date of Patent:** **\*\* Jan. 16, 2007**

(54) **WASTE DISPOSAL CONTAINER**

**DESCRIPTION**

(75) Inventor: **Salvatore Olivetti**, Woodbridge (CA)

(73) Assignee: **Envyrozone Inc.**, Toronto (CA)

(\*\*) Term: **14 Years**

(21) Appl. No.: **29/225,541**

(22) Filed: **Mar. 16, 2005**

(51) **LOC (8) Cl.** ..... **09-09**

(52) **U.S. Cl.** ..... **D34/1; D34/7**

(58) **Field of Classification Search** ..... D34/1,  
D34/5, 6, 7, 8, 9, 10, 11; 220/908-913, 4.32;  
362/812, 28, 29; 40/306; D20/10, 19  
See application file for complete search history.

(56) **References Cited**

**U.S. PATENT DOCUMENTS**

3,394,832	A	*	7/1968	McAllister et al.	.....	220/254.3
D232,211	S	*	7/1974	Kay et al.	.....	D34/8
D356,419	S	*	3/1995	Kamm	.....	D34/7
D379,703	S	*	6/1997	Kent	.....	D34/1
D381,156	S	*	7/1997	Kent	.....	D34/1
D388,922	S	*	1/1998	Peters	.....	D34/1
D428,229	S	*	7/2000	Olivetti	.....	D34/1
6,193,091	B1	*	2/2001	Olivetti	.....	220/23.88
D493,591	S	*	7/2004	Skalka	.....	D34/7
D507,089	S	*	7/2005	Enayati et al.	.....	D34/1

\* cited by examiner

*Primary Examiner*—Cynthia E. Ramirez

(74) *Attorney, Agent, or Firm*—Eric Fincham

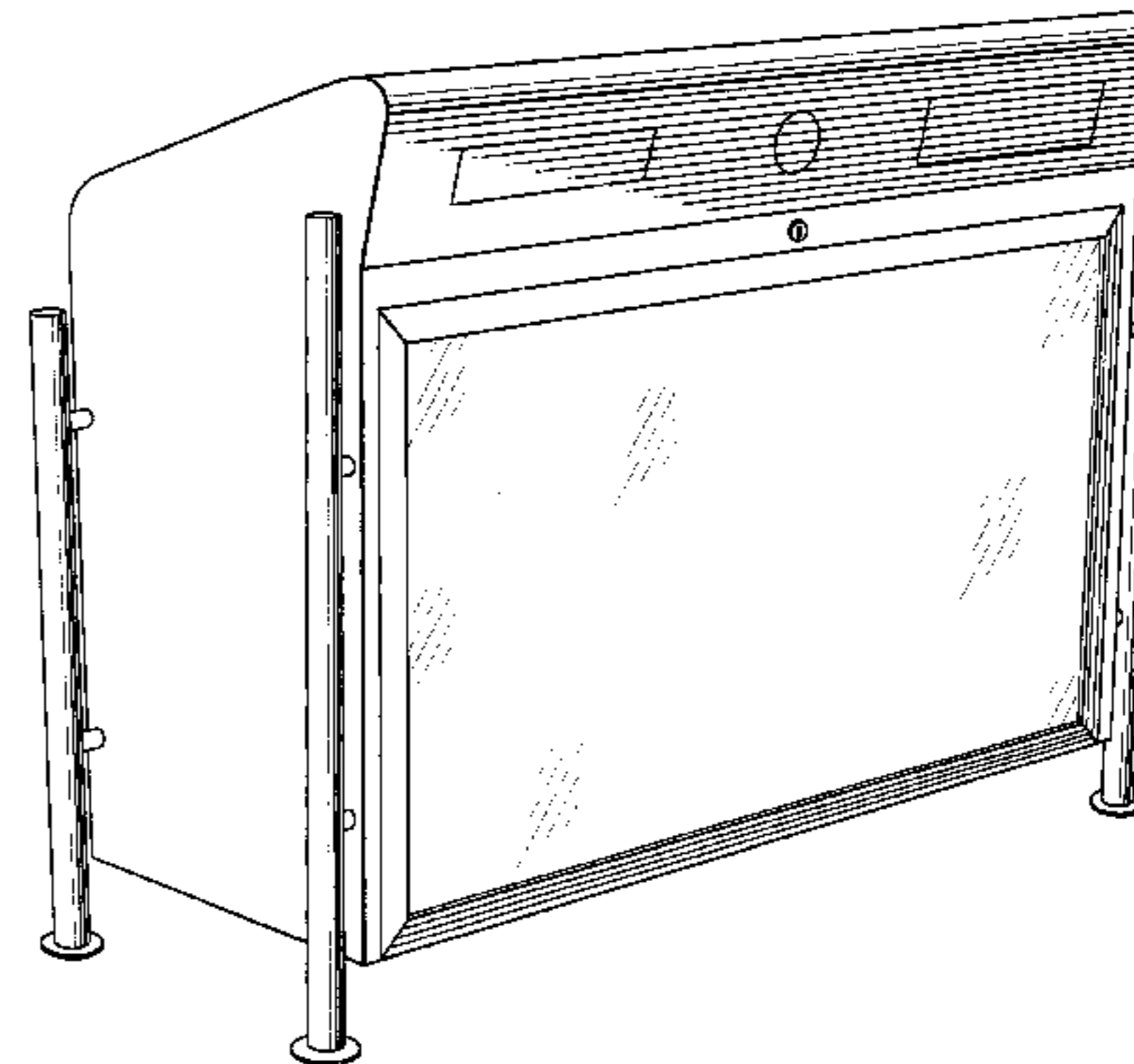
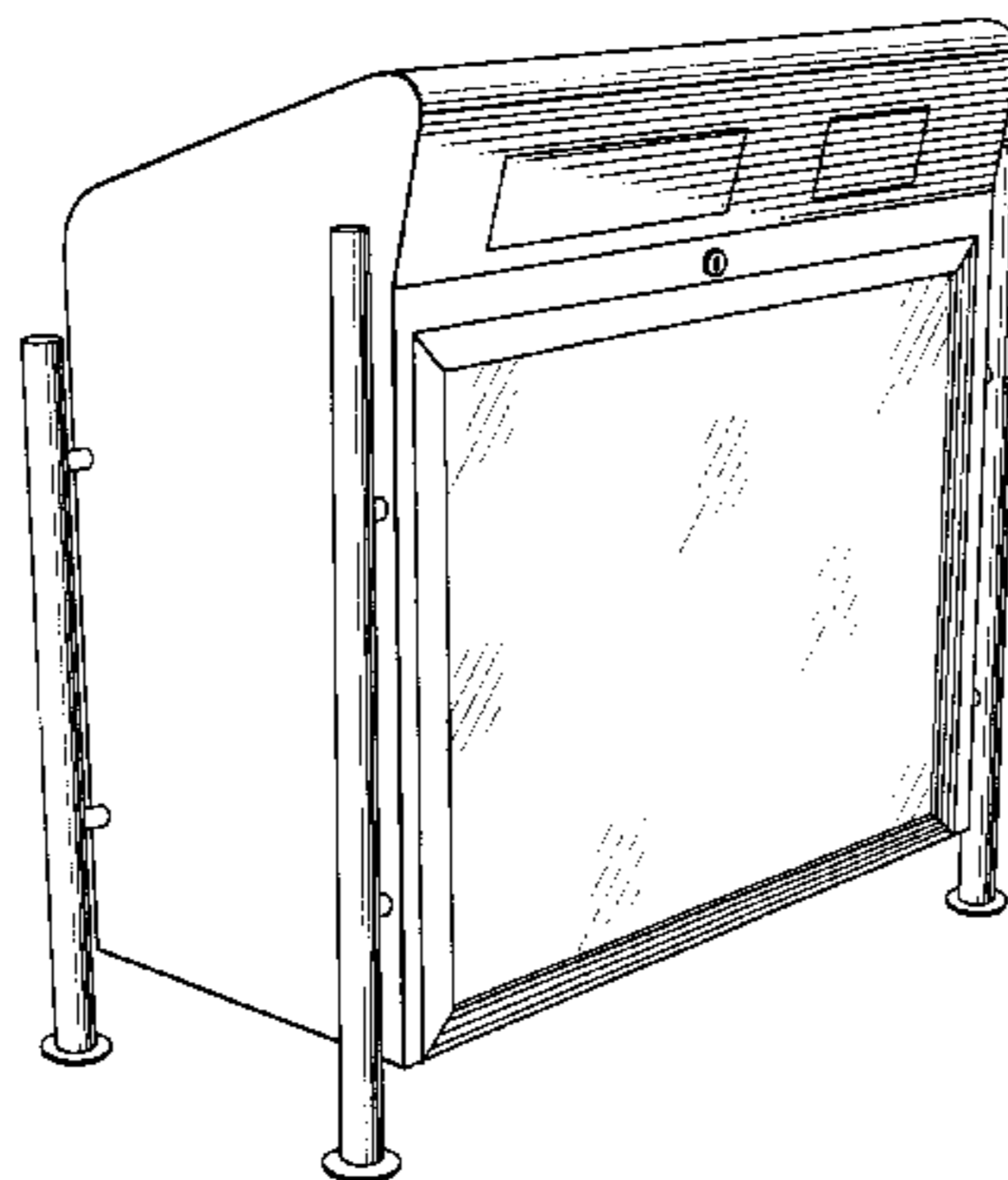
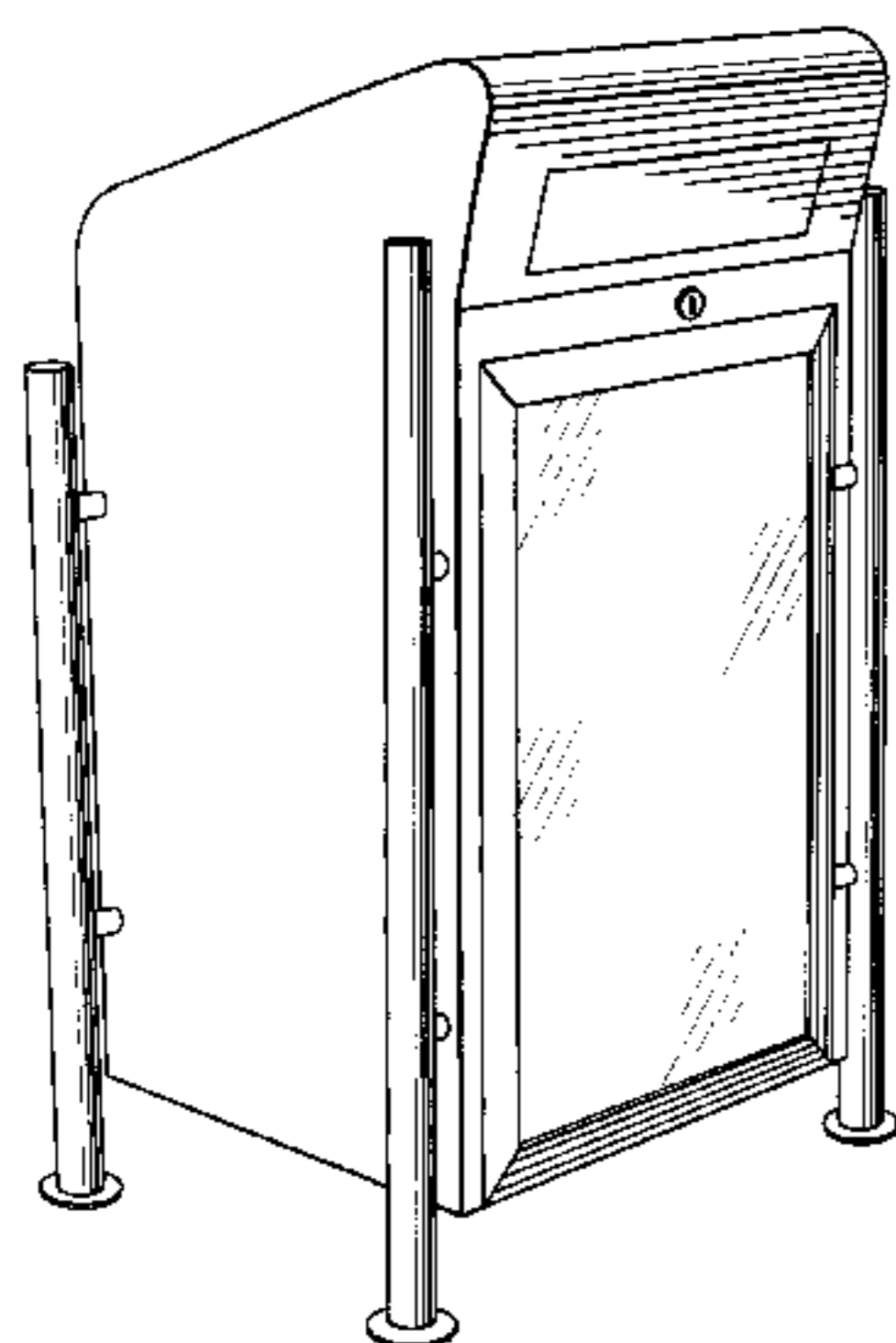
(57) **CLAIM**

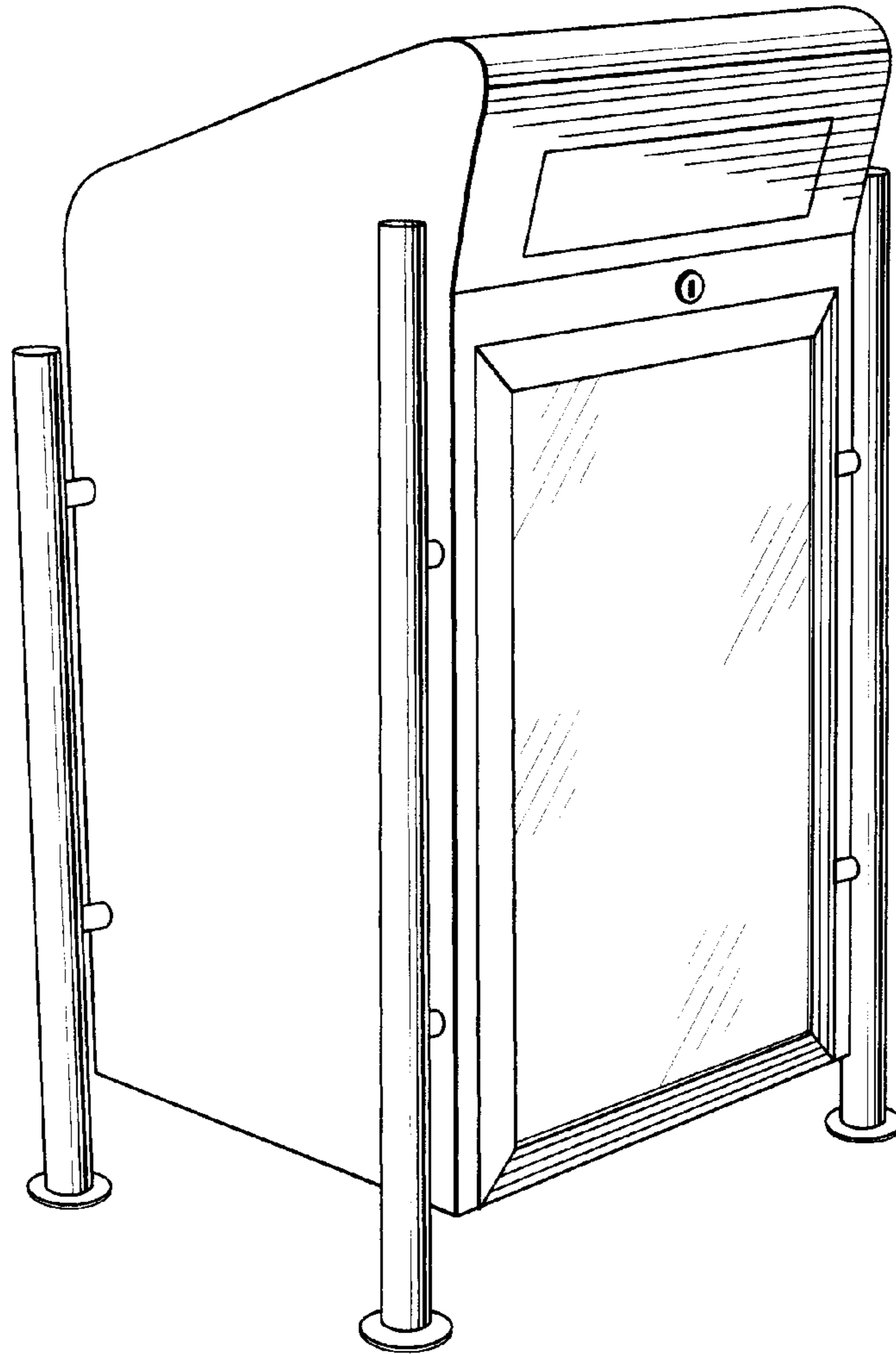
An ornamental design for a waste disposal container, as shown and described.

FIG. 1 is a perspective view of a first variant of the waste disposal container of the instant design;  
 FIG. 2 is a side elevational view thereof as seen from the left hand side of FIG. 1;  
 FIG. 3 is a front elevational view thereof;  
 FIG. 4 is a top plan view thereof;  
 FIG. 5 is a side elevational view as seen from the right hand side of FIG. 1;  
 FIG. 6 is a rear elevational view thereof;  
 FIG. 7 is a bottom plan view thereof;  
 FIG. 8 is a perspective view of a second variant of the waste disposal container of the instant design;  
 FIG. 9 is a side elevational view as seen from the left hand side of FIG. 8;  
 FIG. 10 is a front elevational view thereof;  
 FIG. 11 is a top plan view thereof;  
 FIG. 12 is a side elevational view as seen from the right hand side of FIG. 8;  
 FIG. 13 is a rear elevational view thereof;  
 FIG. 14 is a bottom plan view thereof;  
 FIG. 15 is a perspective view of a third variant of the waste disposal container of the instant design;  
 FIG. 16 is a side elevational view as seen from the left hand side of FIG. 15;  
 FIG. 17 is a front elevational view thereof;  
 FIG. 18 is a top plan view thereof;  
 FIG. 19 is a side elevational view as seen from the right hand side of FIG. 15;  
 FIG. 20 is a rear elevational view thereof; and,  
 FIG. 21 is a bottom plan view thereof.

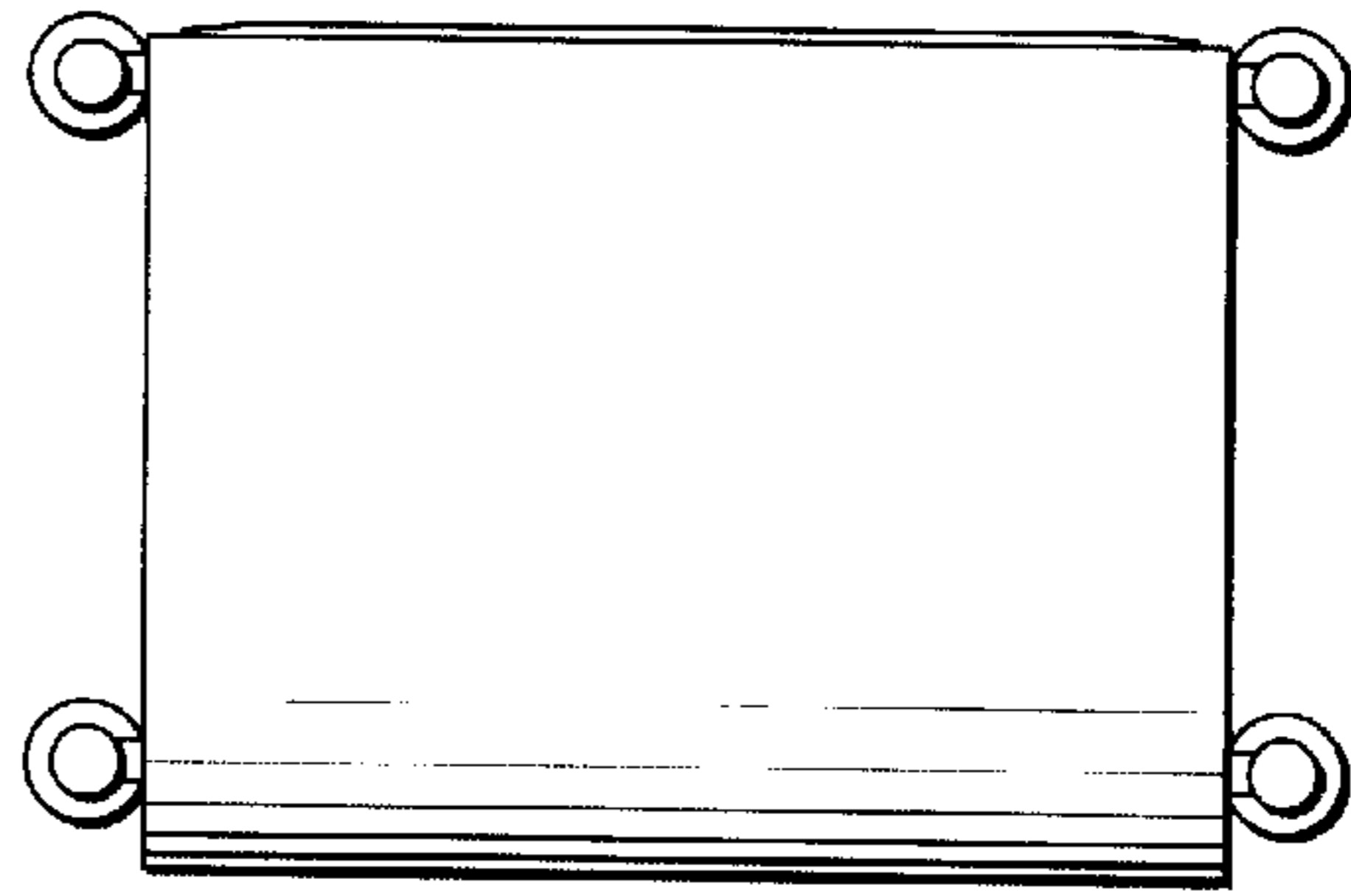
The broken line showing in the figures is for illustrative purposes only and forms no part of the claimed design.

**1 Claim, 9 Drawing Sheets**

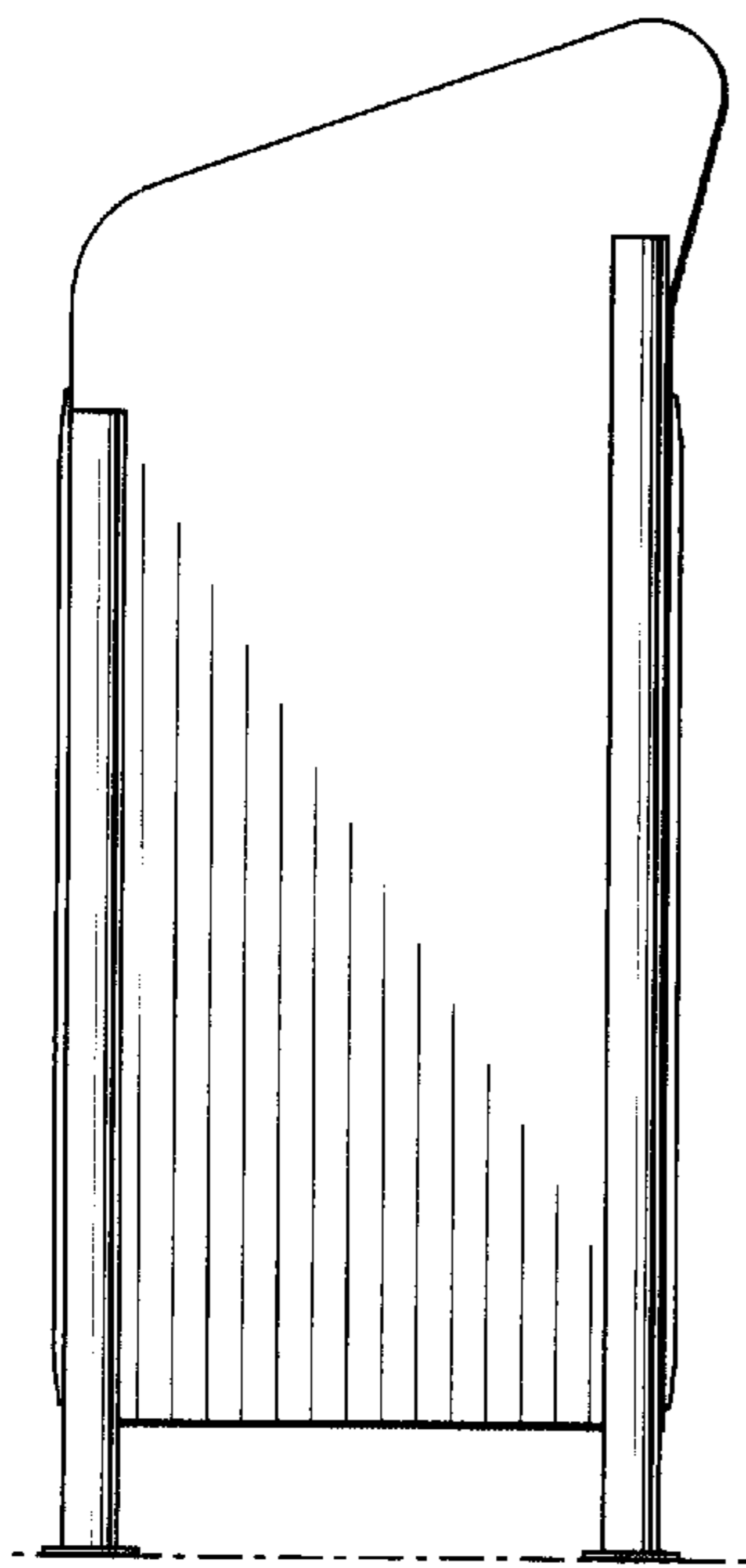




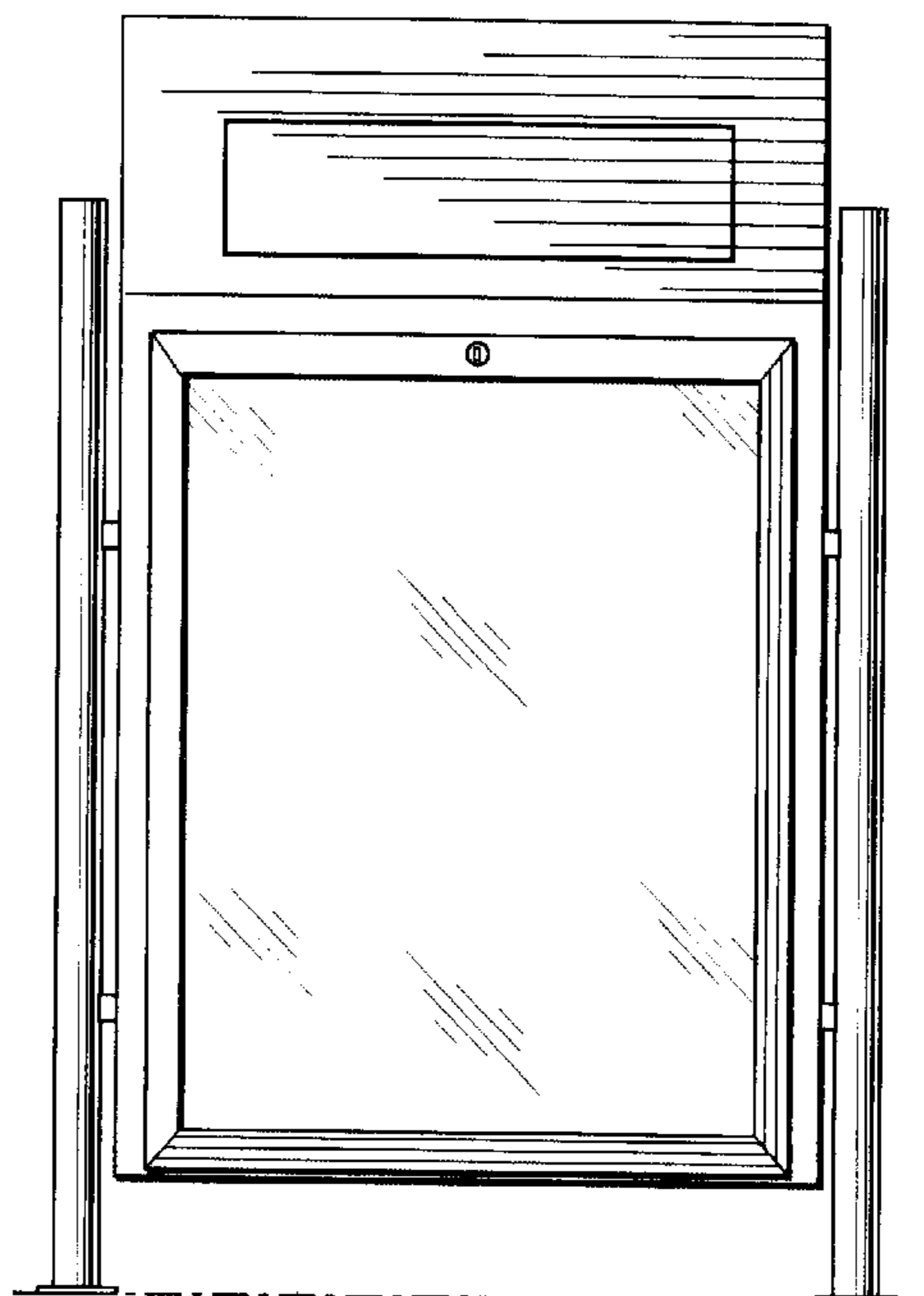
**FIG. 1**



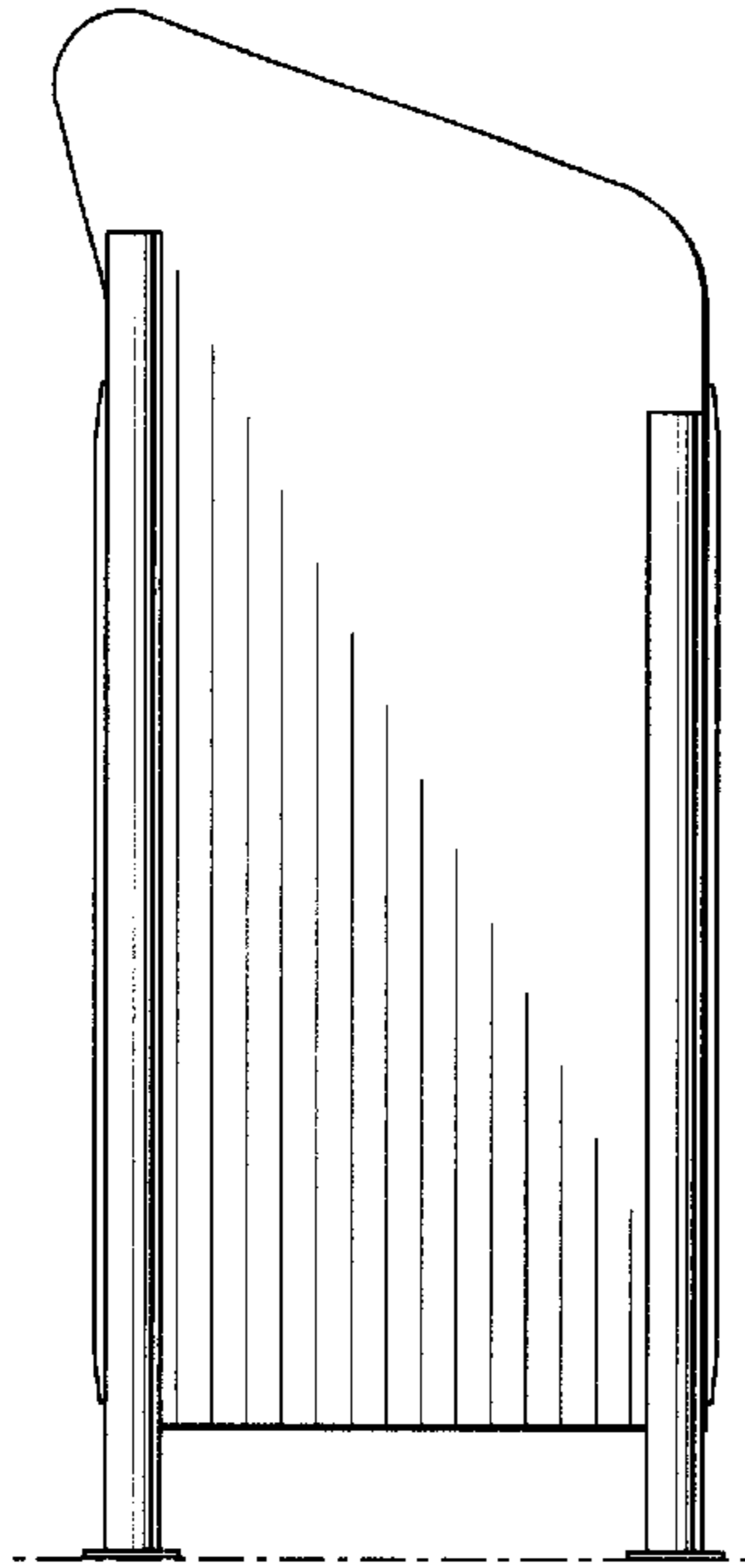
**FIG. 4**



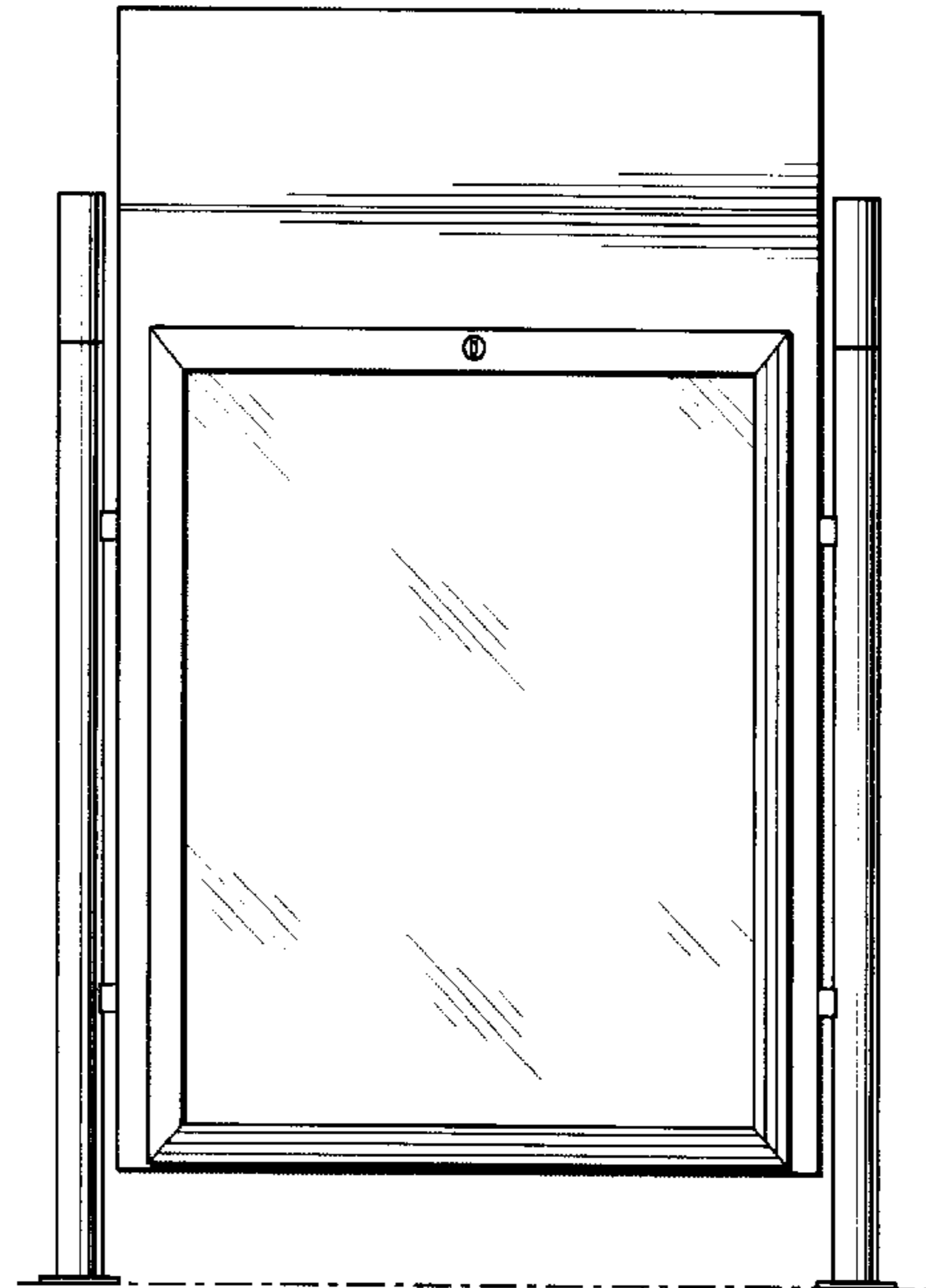
**FIG. 2**



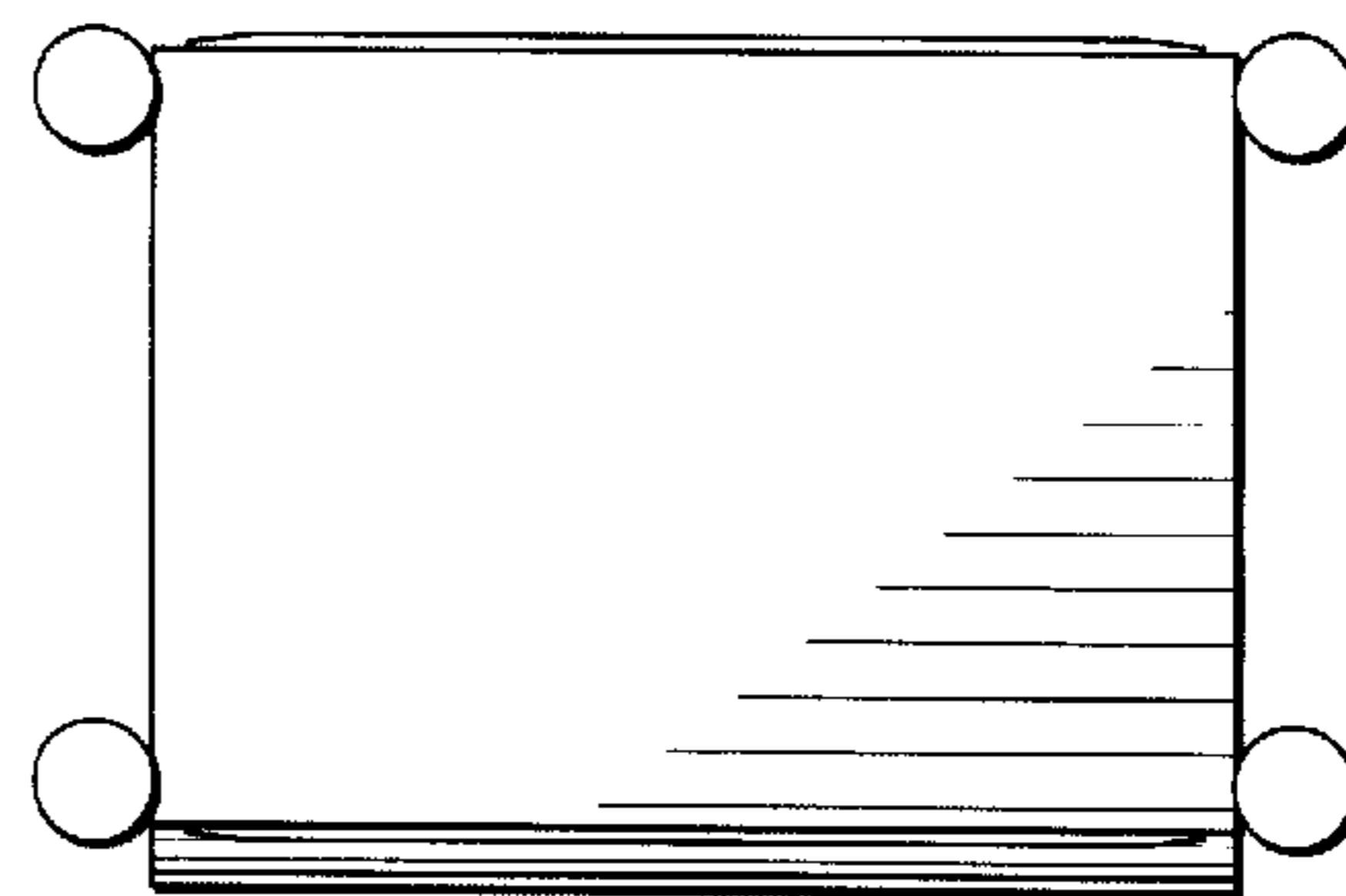
**FIG. 3**



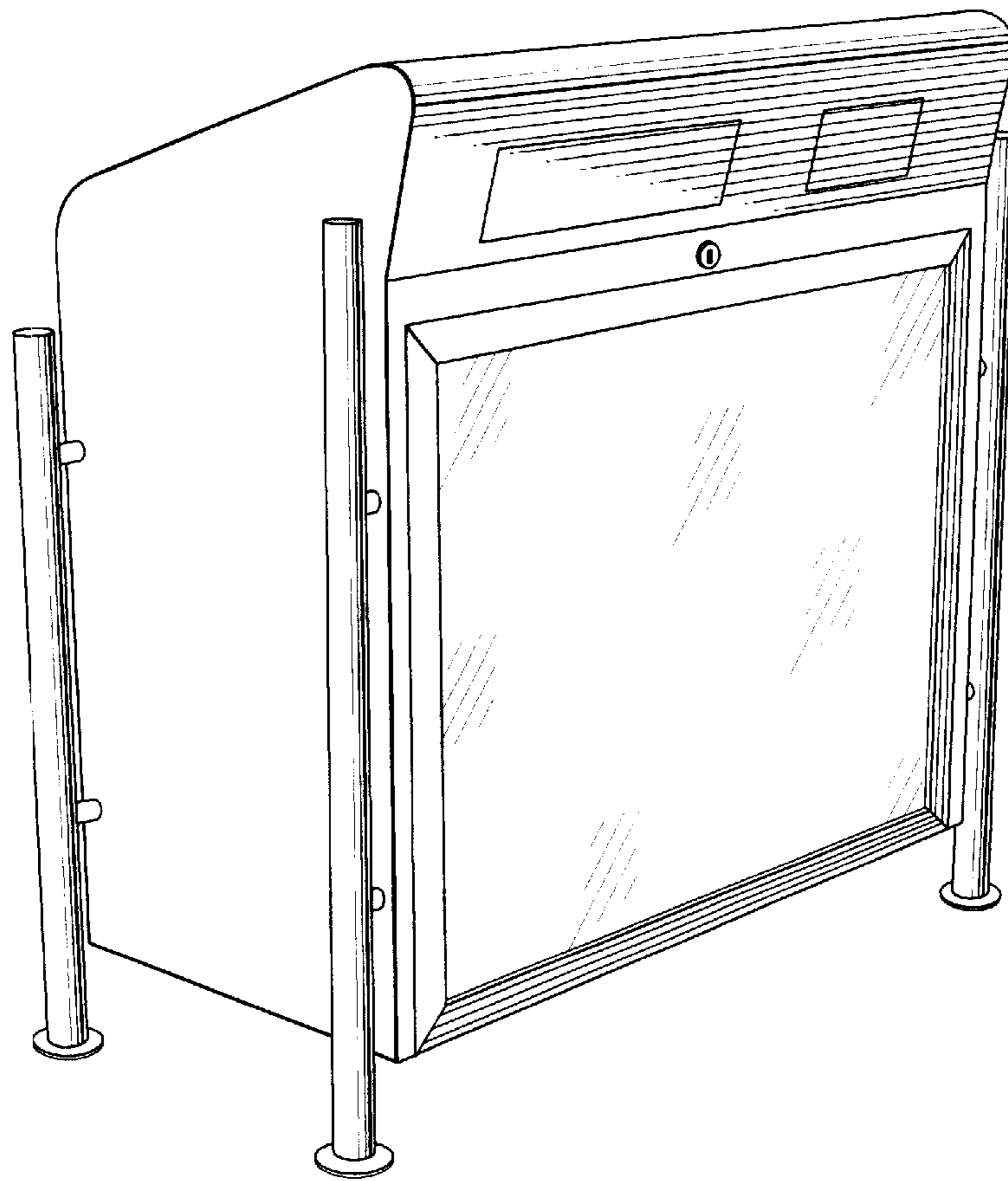
**FIG. 5**



**FIG. 6**



**FIG. 7**



**FIG. 8**

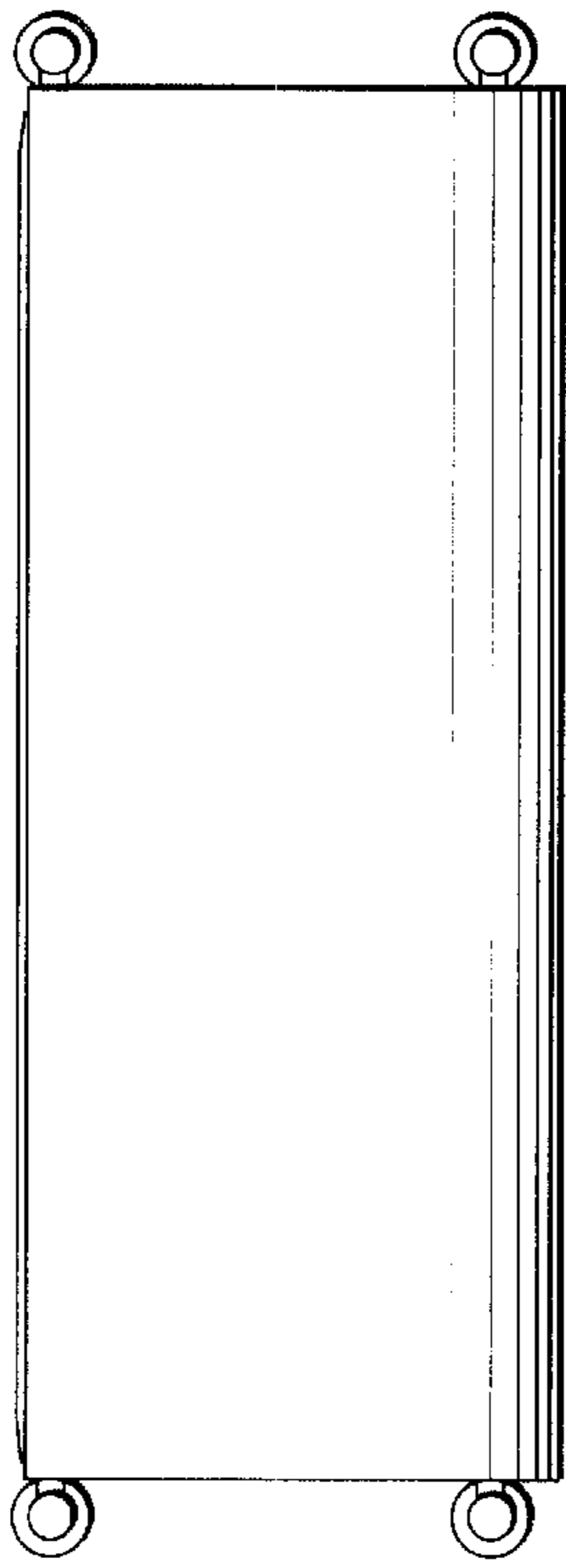


FIG. 11

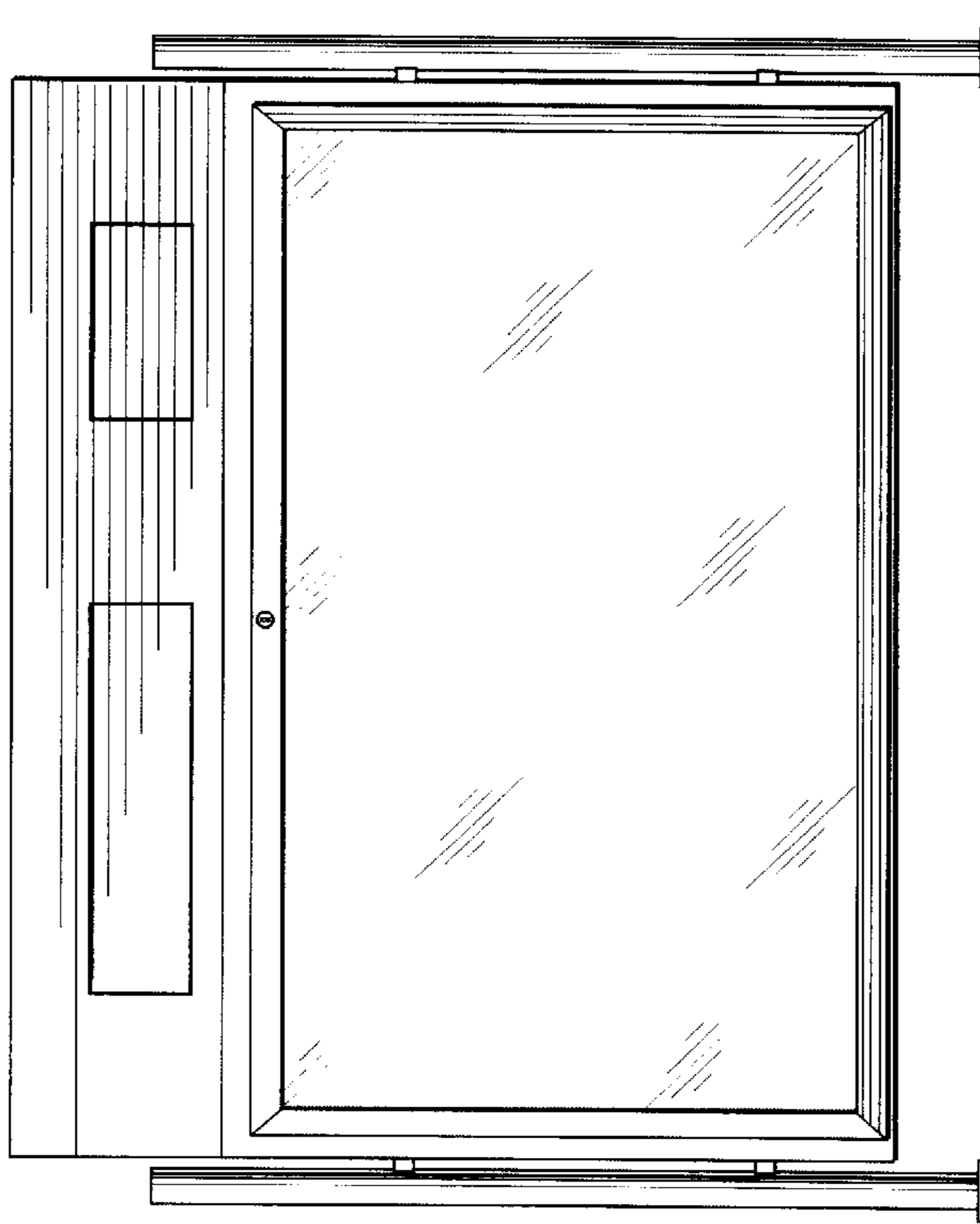


FIG. 10

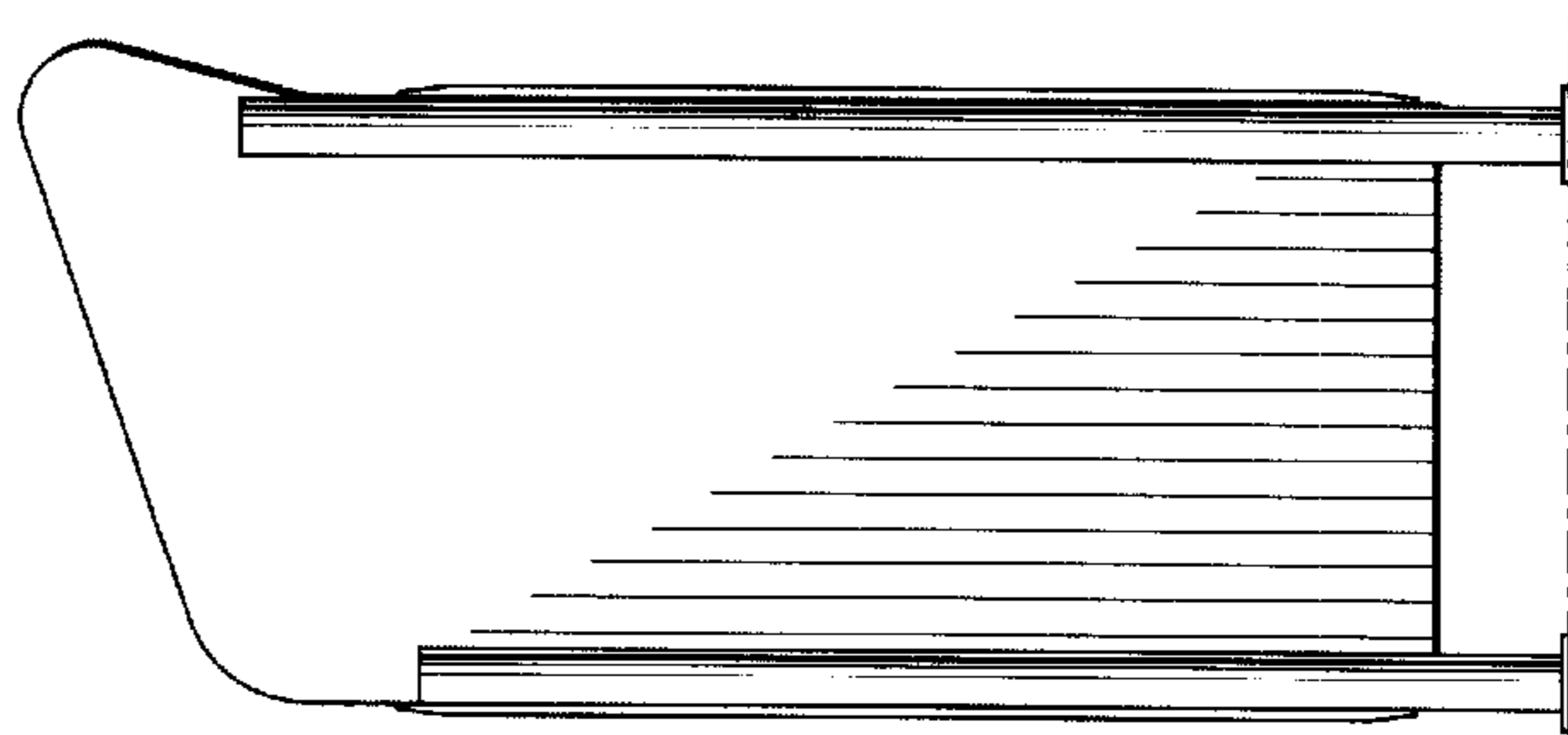


FIG. 9

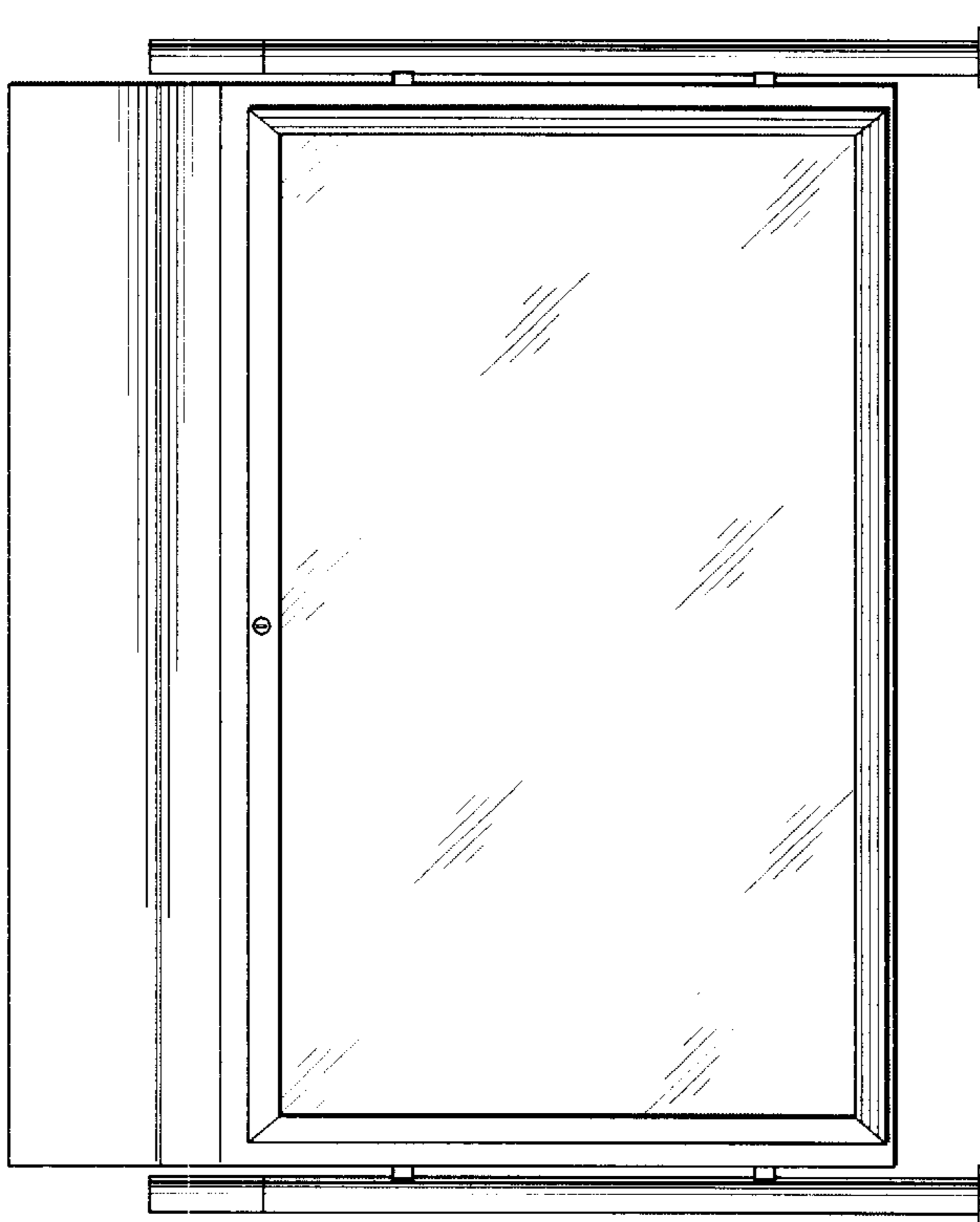


FIG. 13

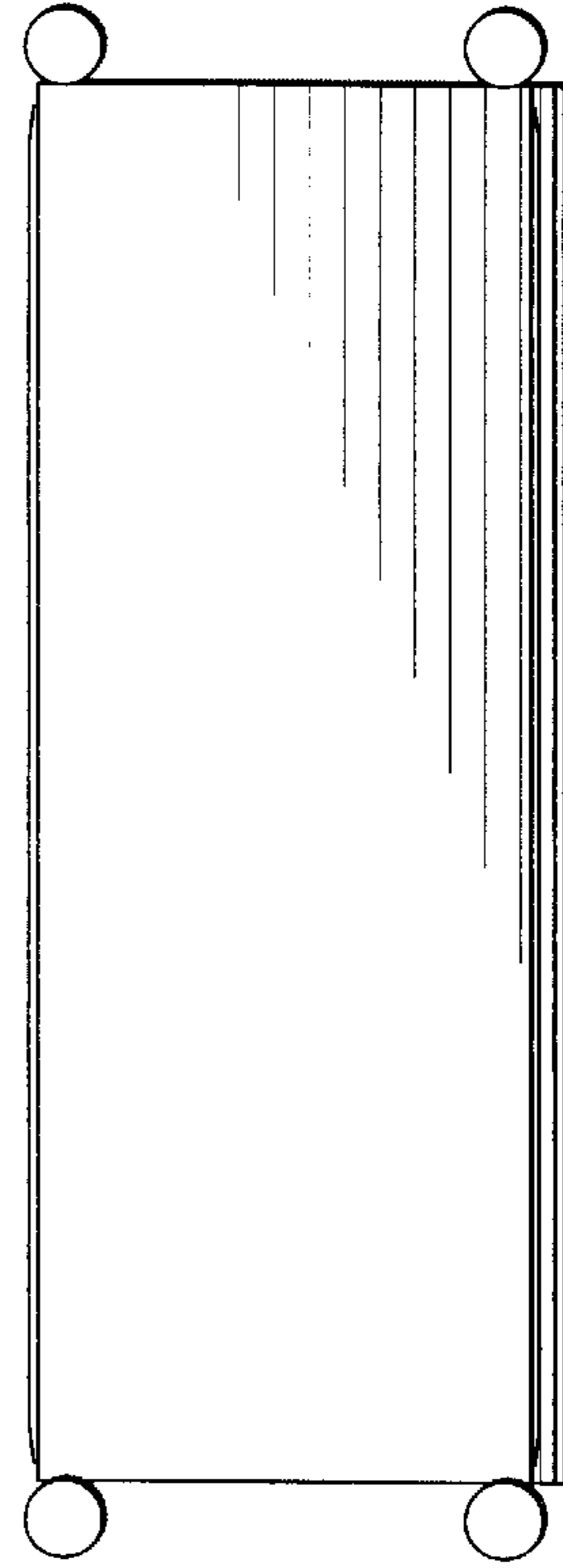


FIG. 14

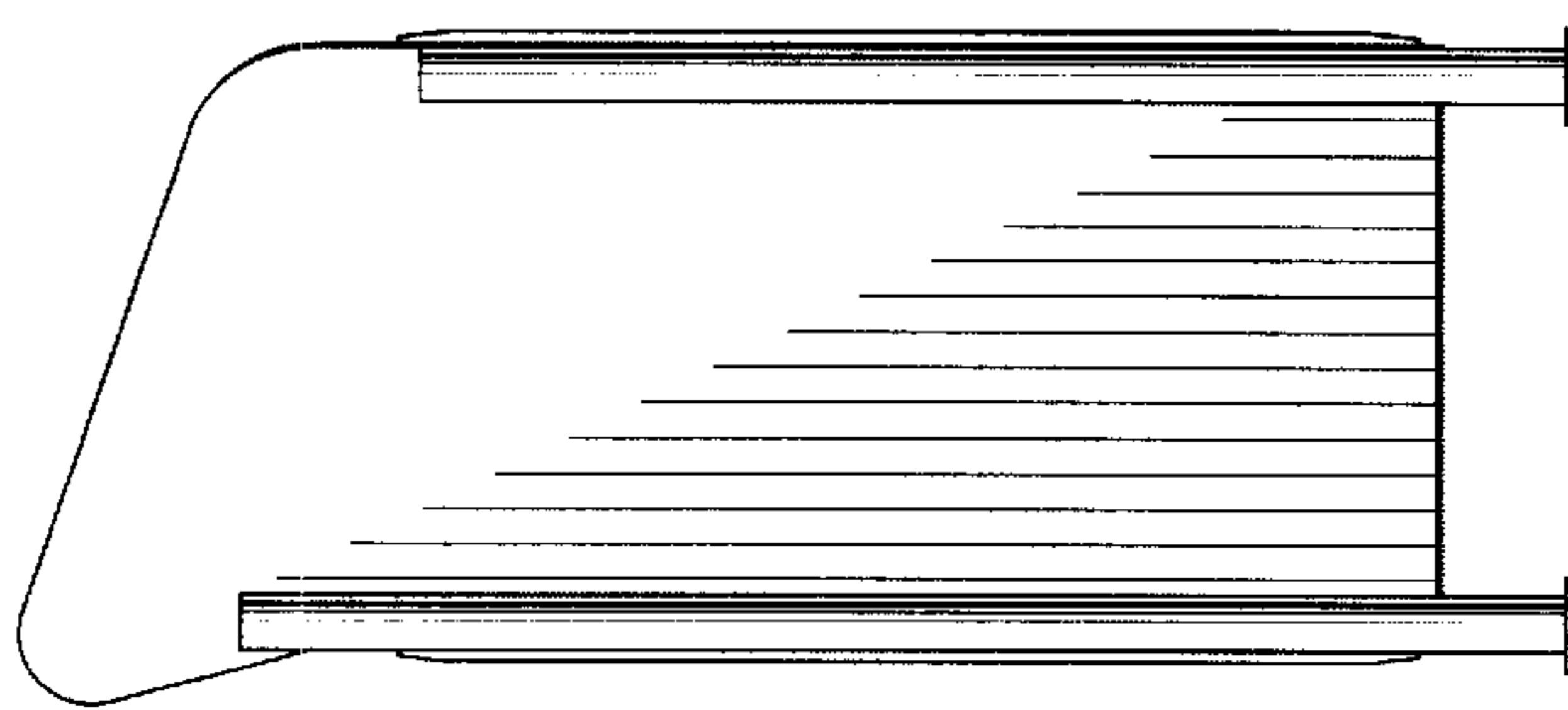
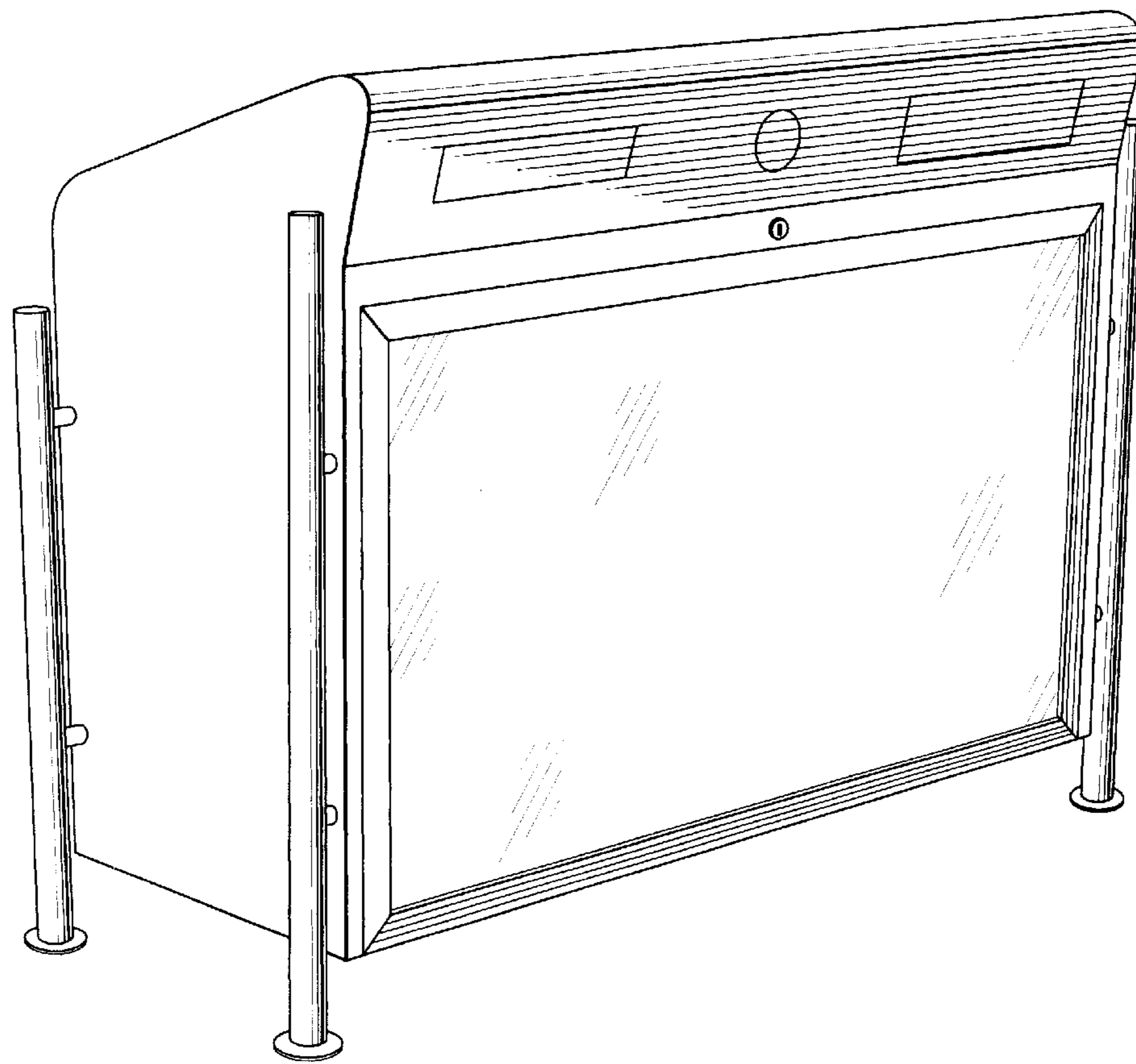


FIG. 12



**FIG. 15**



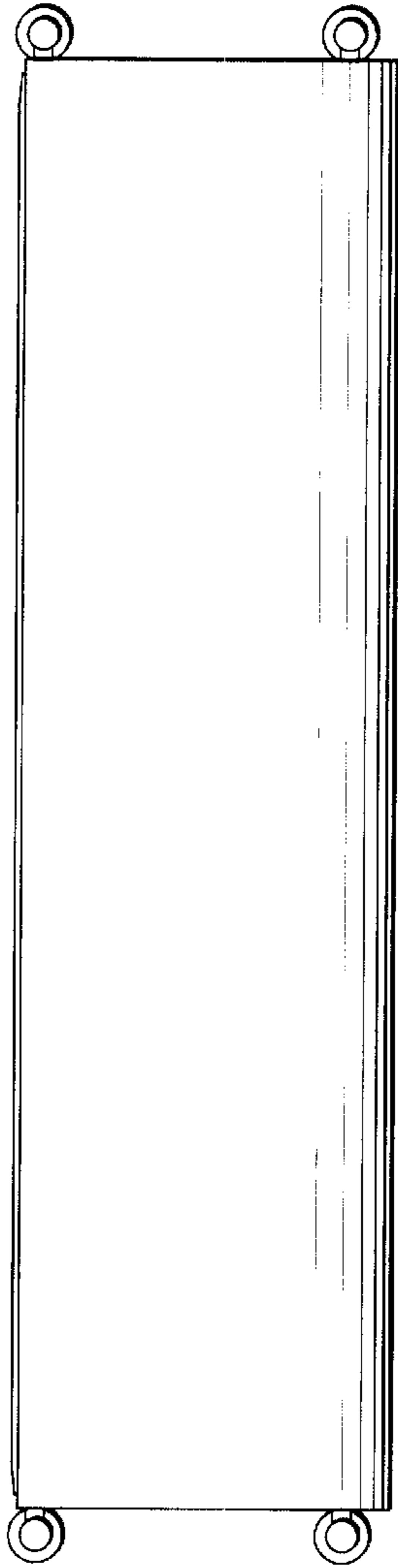


FIG. 18

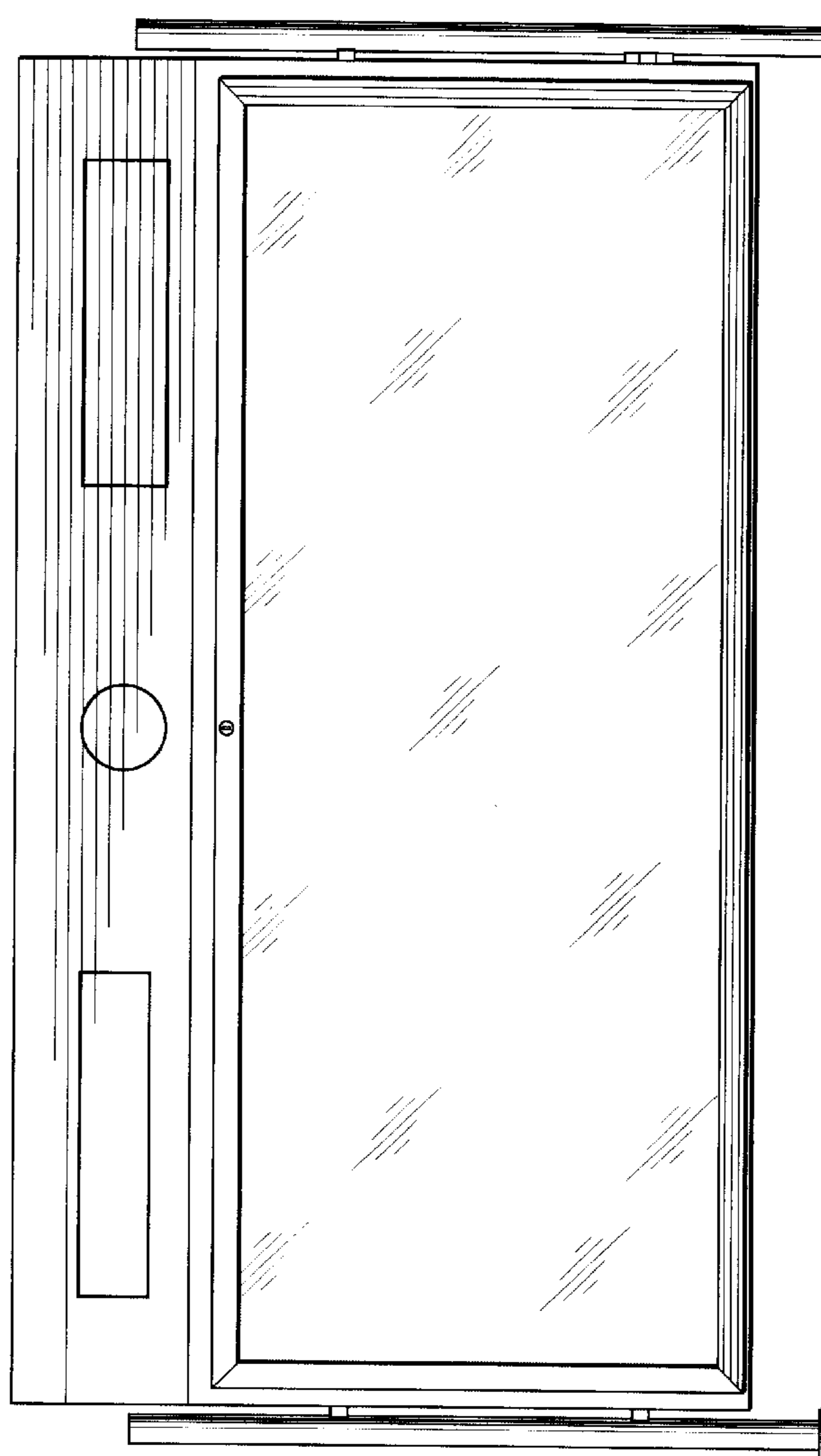


FIG. 17

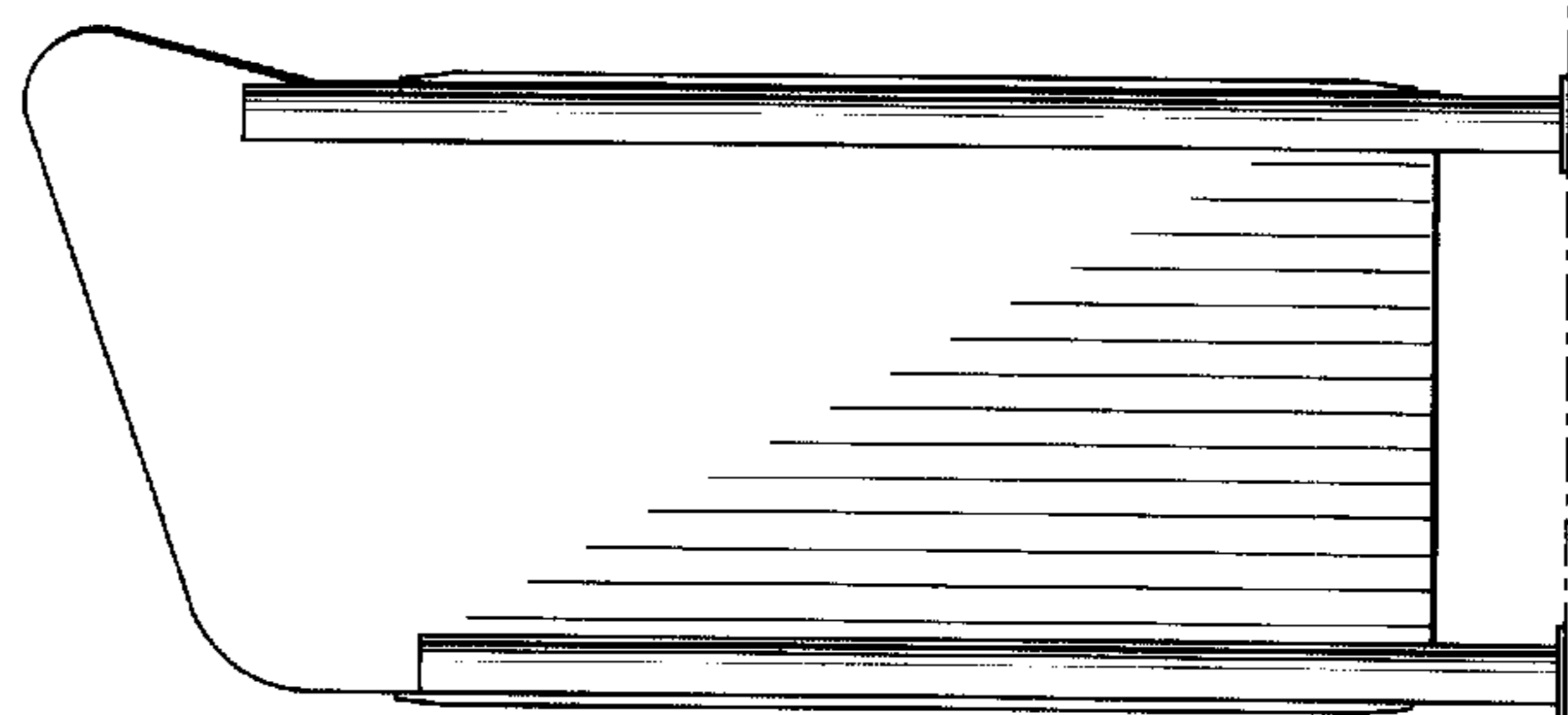


FIG. 16

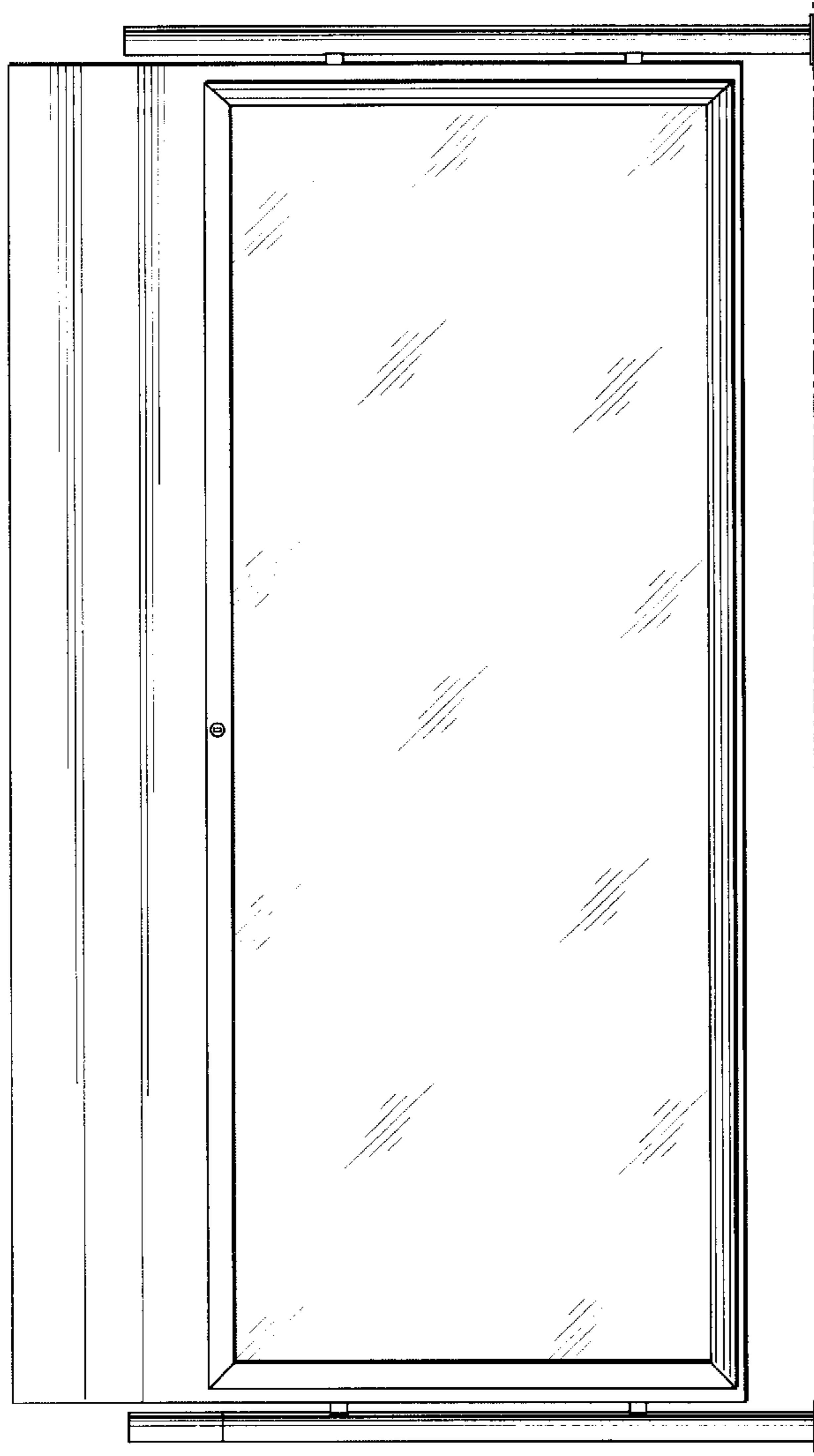


FIG. 20

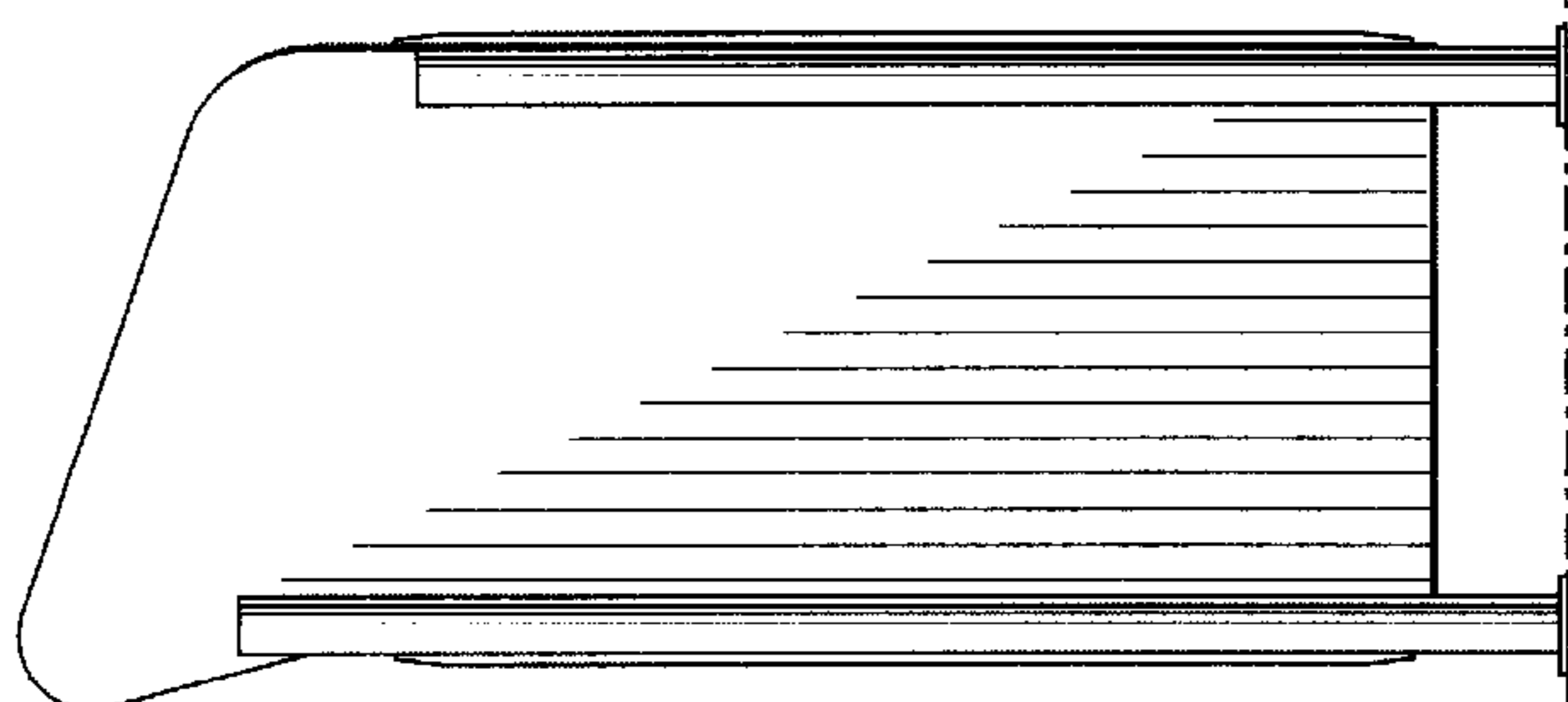


FIG. 19

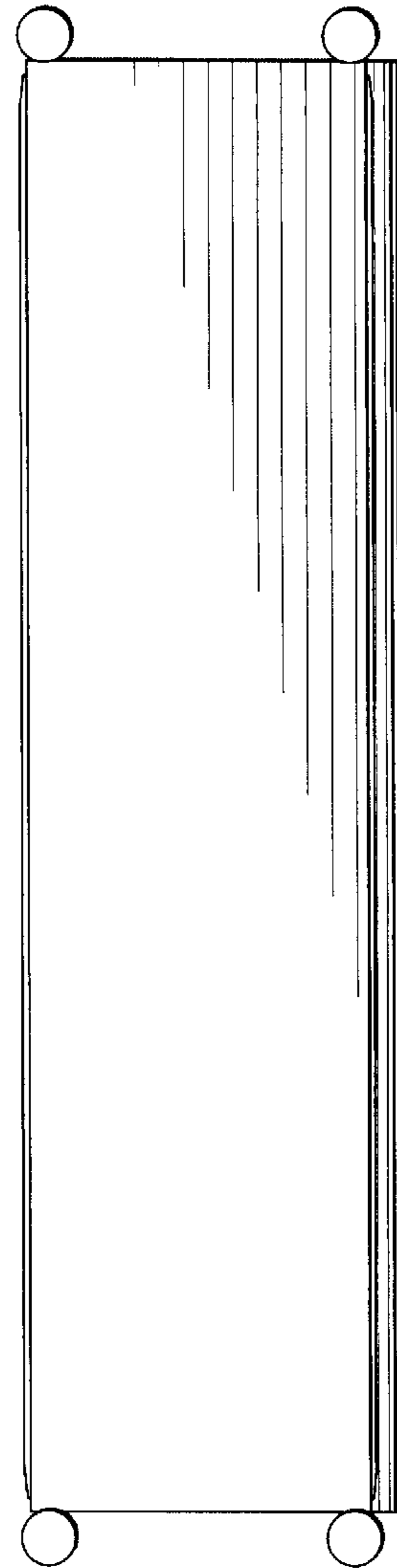


FIG. 21