



US00D535405S

(12) **United States Design Patent**
Stein et al.

(10) **Patent No.:** **US D535,405 S**

(45) **Date of Patent:** **** Jan. 16, 2007**

(54) **CATHEDRAL FENCE SECTION**

(75) Inventors: **Robert J. Stein**, Aurora, IL (US);
Torrence Anderson, Overland Park, KS (US)

(73) Assignee: **Suncast Corporation**, Batavia, IL (US)

(**) Term: **14 Years**

(21) Appl. No.: **29/240,047**

(22) Filed: **Oct. 7, 2005**

(51) **LOC (8) Cl.** **25-02**

(52) **U.S. Cl.** **D25/38**

(58) **Field of Classification Search** 256/73,
256/1, 59, 67, 65.02, 65.11, 65.15, 65.16,
256/19, 21, 22, 24, 25; D25/38, 42, 44, 50
See application file for complete search history.

(56) **References Cited**

U.S. PATENT DOCUMENTS

4,143,857 A * 3/1979 Weiner 256/11
5,609,327 A * 3/1997 Amidon 256/24
D419,688 S * 1/2000 Rau D25/38

6,138,993 A * 10/2000 Mitchell et al. 256/25

* cited by examiner

Primary Examiner—Doris Clark

(74) *Attorney, Agent, or Firm*—McHale & Slavin PA

(57) **CLAIM**

The ornamental design for a cathedral fence section, as shown and described.

DESCRIPTION

FIG. 1 is a front perspective view of the cathedral fence section of the instant invention;
FIG. 2 is a front elevation view thereof;
FIG. 3 is a rear elevation view thereof;
FIG. 4 is a left elevation view thereof;
FIG. 5 is a right elevation view thereof;
FIG. 6 is a top plan view thereof;
FIG. 7 is a bottom plan view thereof; and,
FIG. 8 is a perspective view illustrating a plurality of assembled cathedral fence sections, the fence sections depicted with hidden lines form no part of the claimed design.

1 Claim, 6 Drawing Sheets

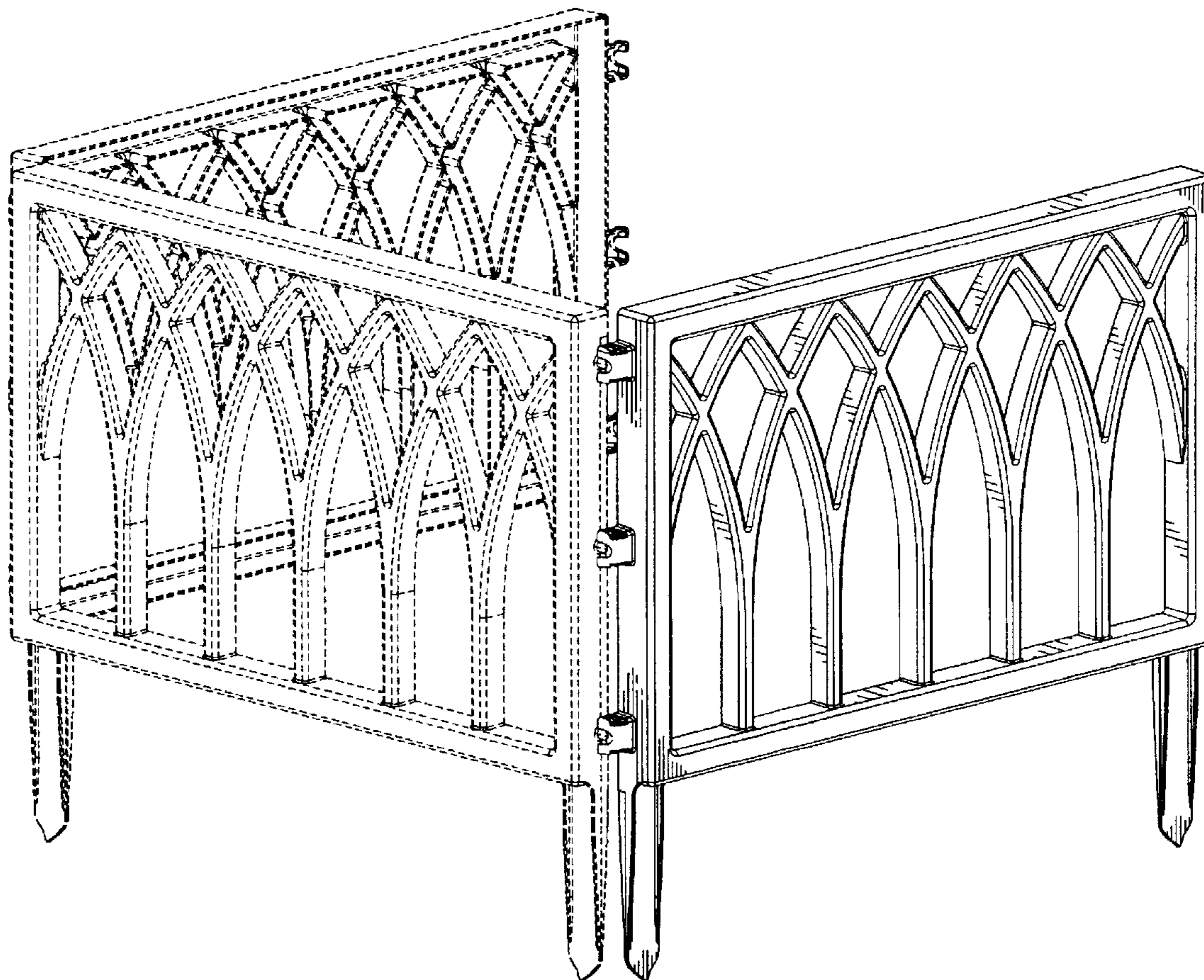

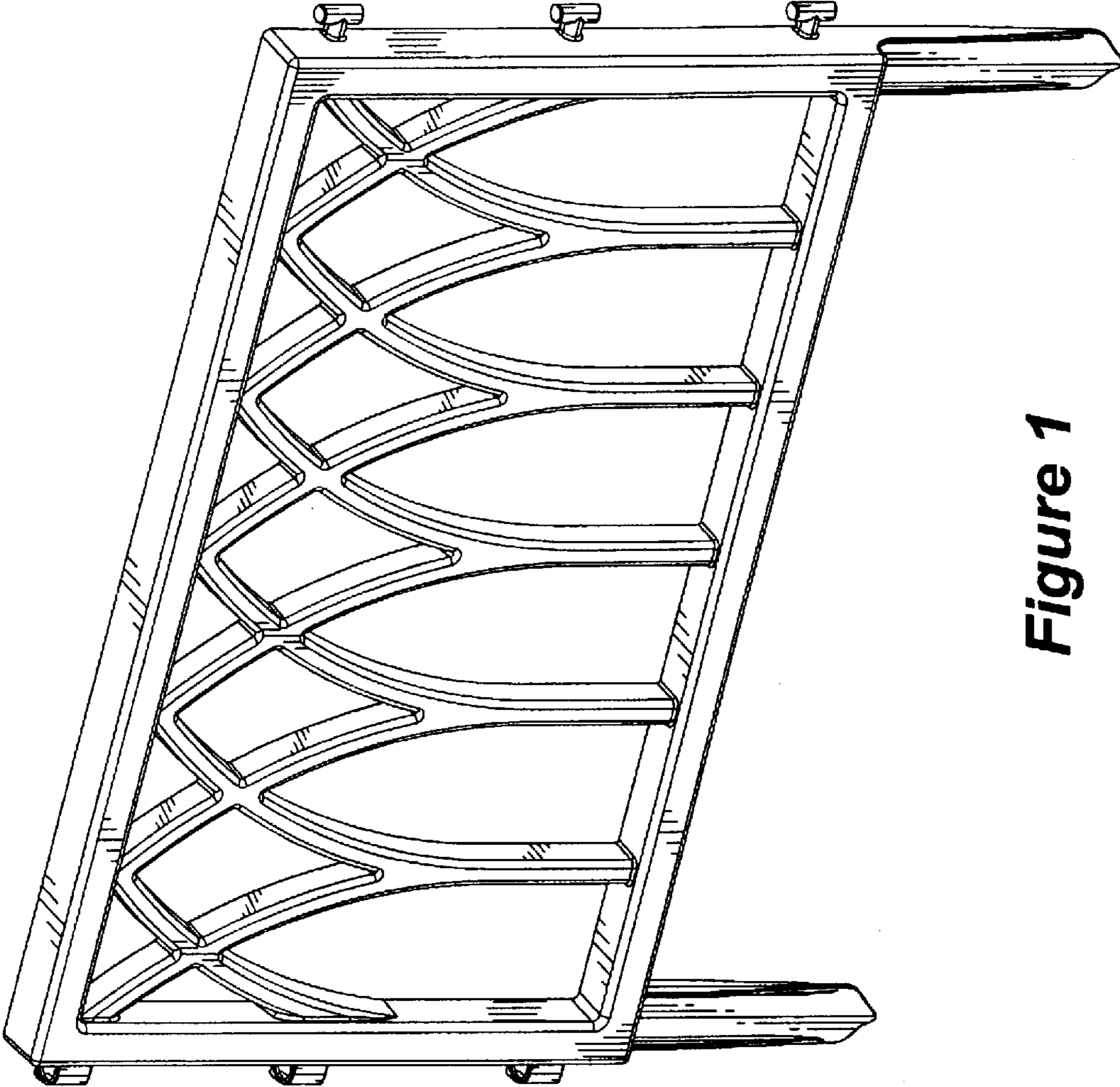

Figure 1

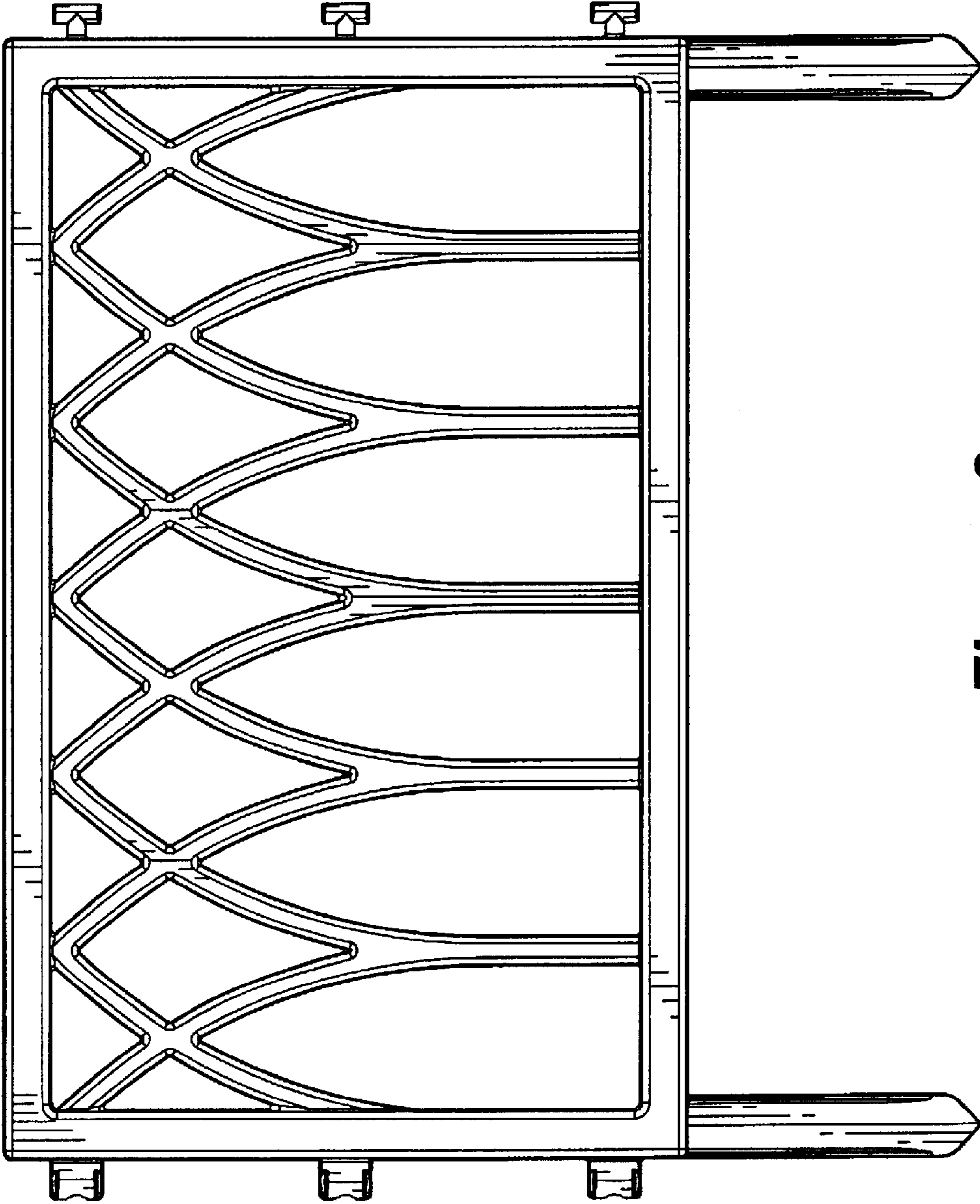

Figure 2

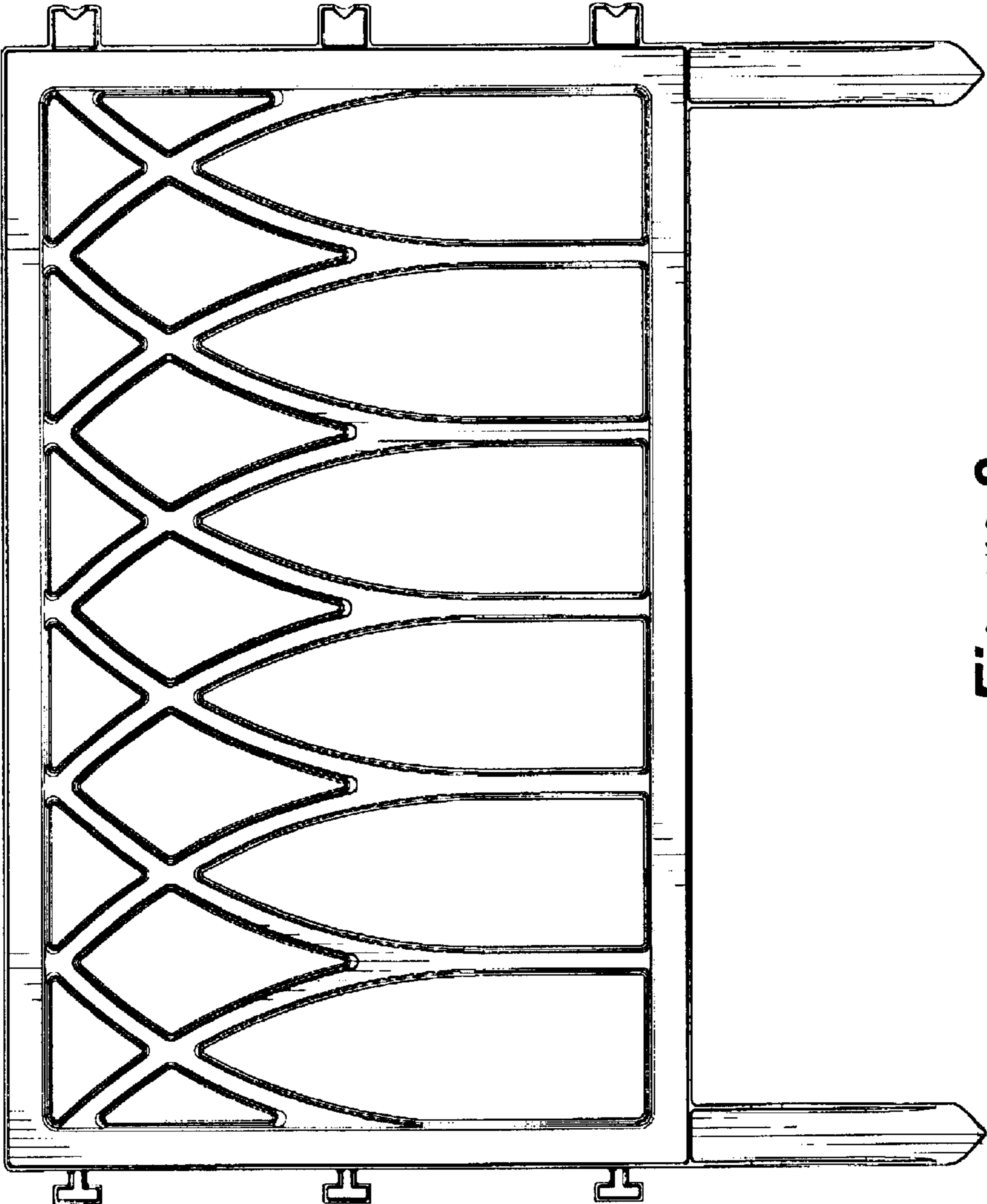

Figure 3



Figure 5

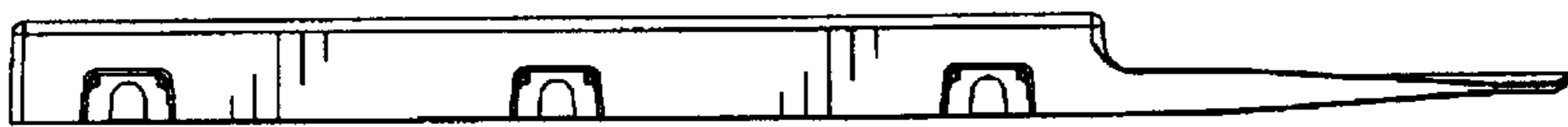

Figure 4

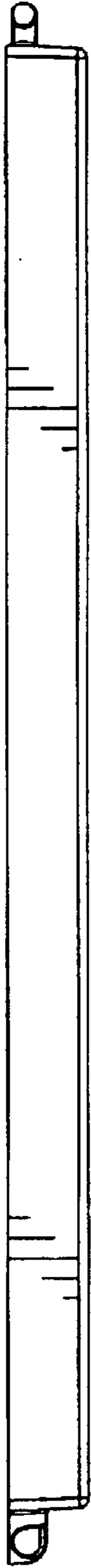

Figure 6



Figure 7

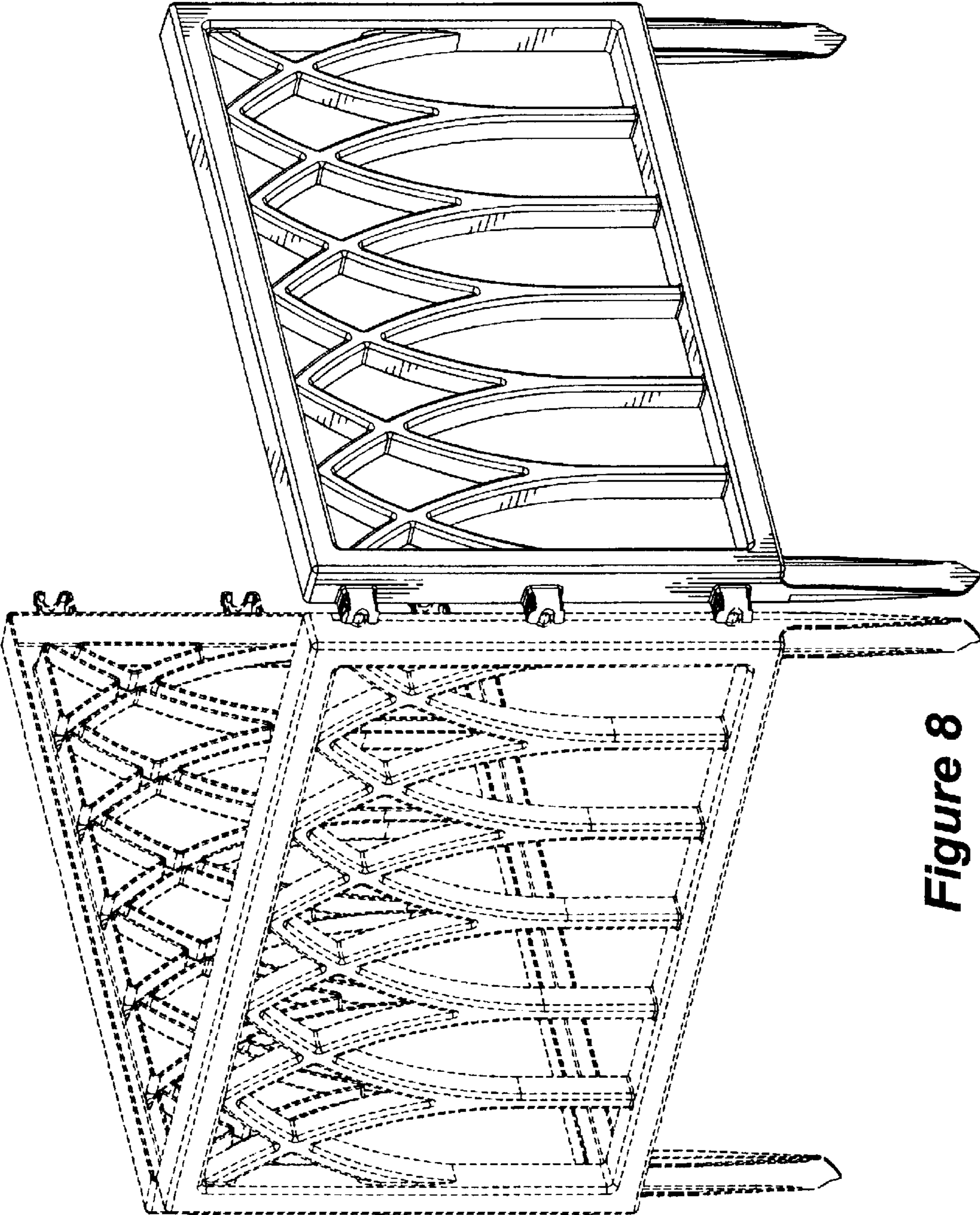

Figure 8