



US00D535390S

(12) **United States Design Patent**
Stawski et al.

(10) **Patent No.:** **US D535,390 S**
(45) **Date of Patent:** **** Jan. 16, 2007**

(54) **OVAL TABLET**

(75) Inventors: **Barbara Z. Stawski**, Forest Park, IL (US); **Thomas M. Mindak**, Itasca, IL (US); **Ingo C. Theurer**, München (DE); **Philip Mark Soukup**, Freiburg (DE); **Stefan Johannes Brehm**, Kolbermoor (DE)

(73) Assignee: **Wm. Wrigley Jr. Company**, Chicago, IL (US)

(**) Term: **14 Years**

(21) Appl. No.: **29/228,459**

(22) Filed: **Apr. 22, 2005**

(51) **LOC (8) Cl.** **28-01**

(52) **U.S. Cl.** **D24/101**

(58) **Field of Classification Search** D24/100–104; D28/4, 8.1, 8.2; D1/100, 121, 125–130; 424/464–482
See application file for complete search history.

(56) **References Cited**

U.S. PATENT DOCUMENTS

315,559	A	*	4/1885	Schwarzschild et al.	D1/127
D28,455	S	*	4/1898	Baker	D1/130
2,613,185	A	*	10/1952	Marshall	D28/8.1
D187,372	S	*	3/1960	Dailey	D24/101
2,928,770	A	*	3/1960	Bardani	424/469
D228,456	S	*	9/1973	Ninger	D24/103
D252,054	S	*	6/1979	Carles	D24/101
D285,490	S		9/1986	Tovey		

D297,575	S	*	9/1988	Yates	D24/103
D375,383	S	*	11/1996	Williams	D28/8.1
6,004,334	A		12/1999	Mythen		
D442,334	S		5/2001	Friesenhahn		

FOREIGN PATENT DOCUMENTS

GB 2024180 * 12/1992

* cited by examiner

Primary Examiner—Charles A. Rademaker

(74) *Attorney, Agent, or Firm*—Steven P. Shurtz; Brinks Hofer Gilson & Lione

(57) **CLAIM**

The ornamental design for an oval tablet, as shown and described.

DESCRIPTION

FIG. 1 is a top perspective view of an oval tablet showing our new design with portions shown in stippling to indicate color contrast;

FIG. 2 is a right end elevation thereof, the side opposite being a mirror image;

FIG. 3 is a front elevation, the side opposite being a mirror image thereof;

FIG. 4 is a top plan view thereof;

FIG. 5 is a bottom plan view thereof; and,

FIG. 6 is a top perspective view of a modified embodiment of the design shown in FIGS. 1 through 5, the other views being identical thereto apart from the lack of stippling to indicate color contrast.

1 Claim, 2 Drawing Sheets

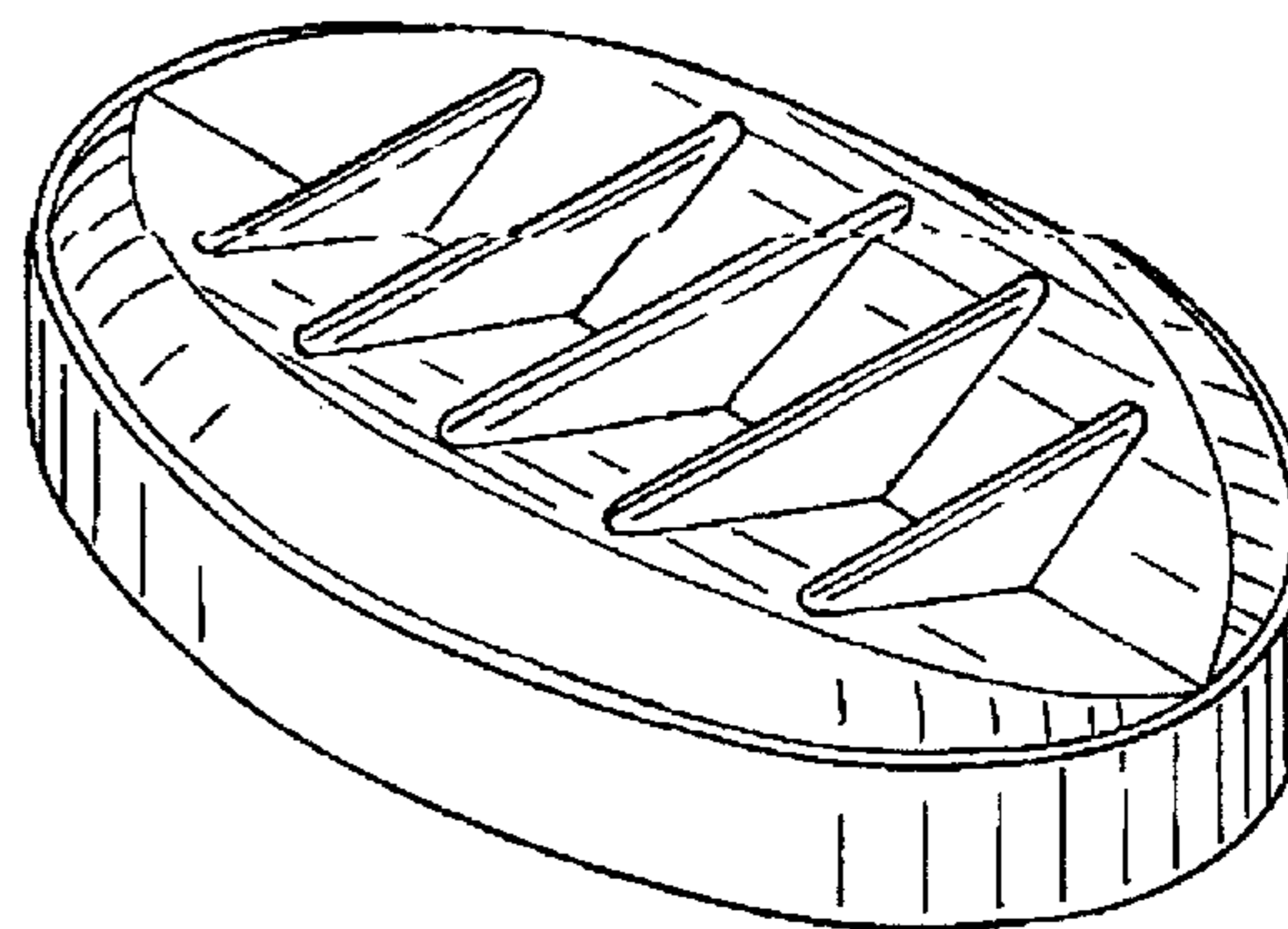
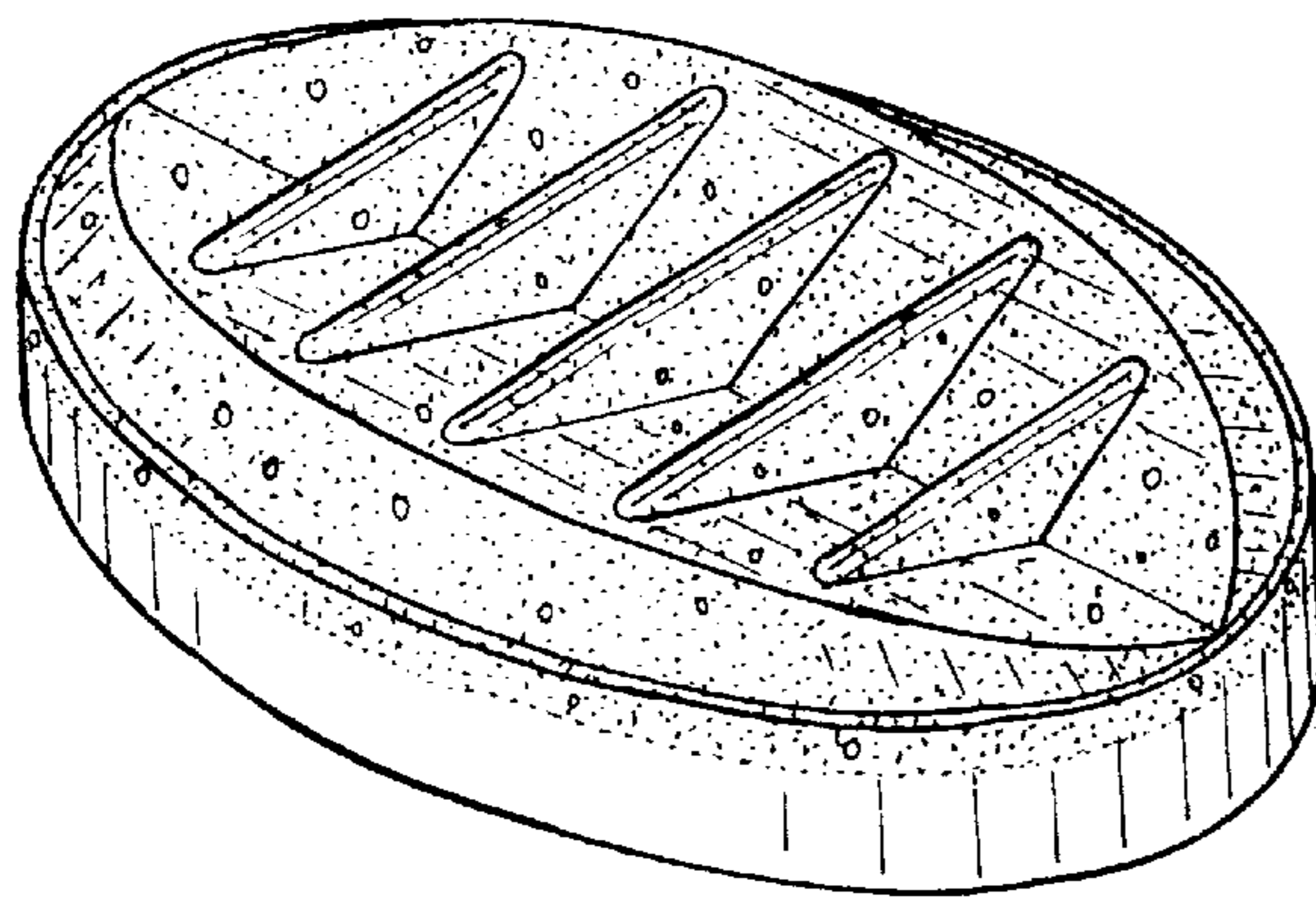

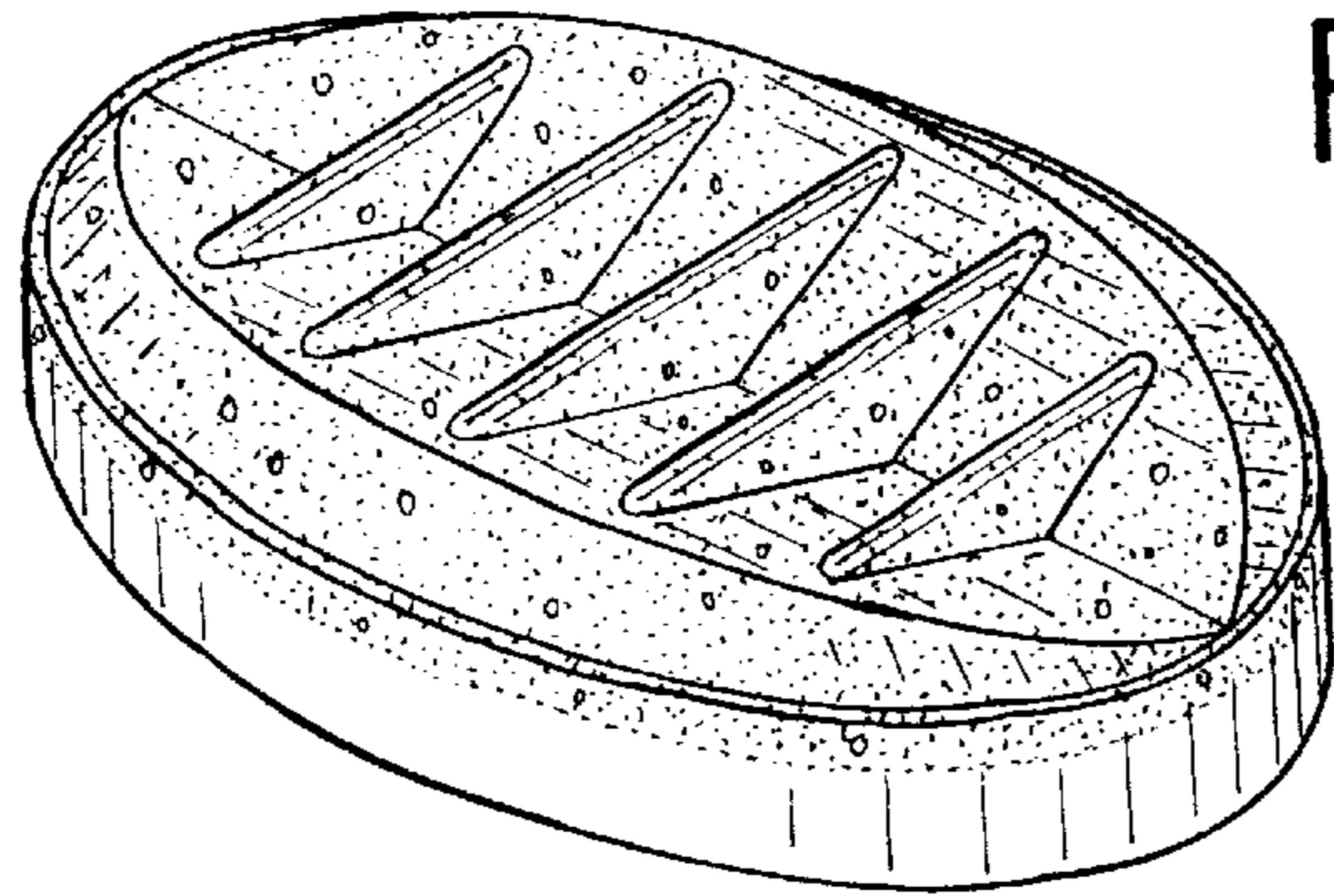

FIG. 1

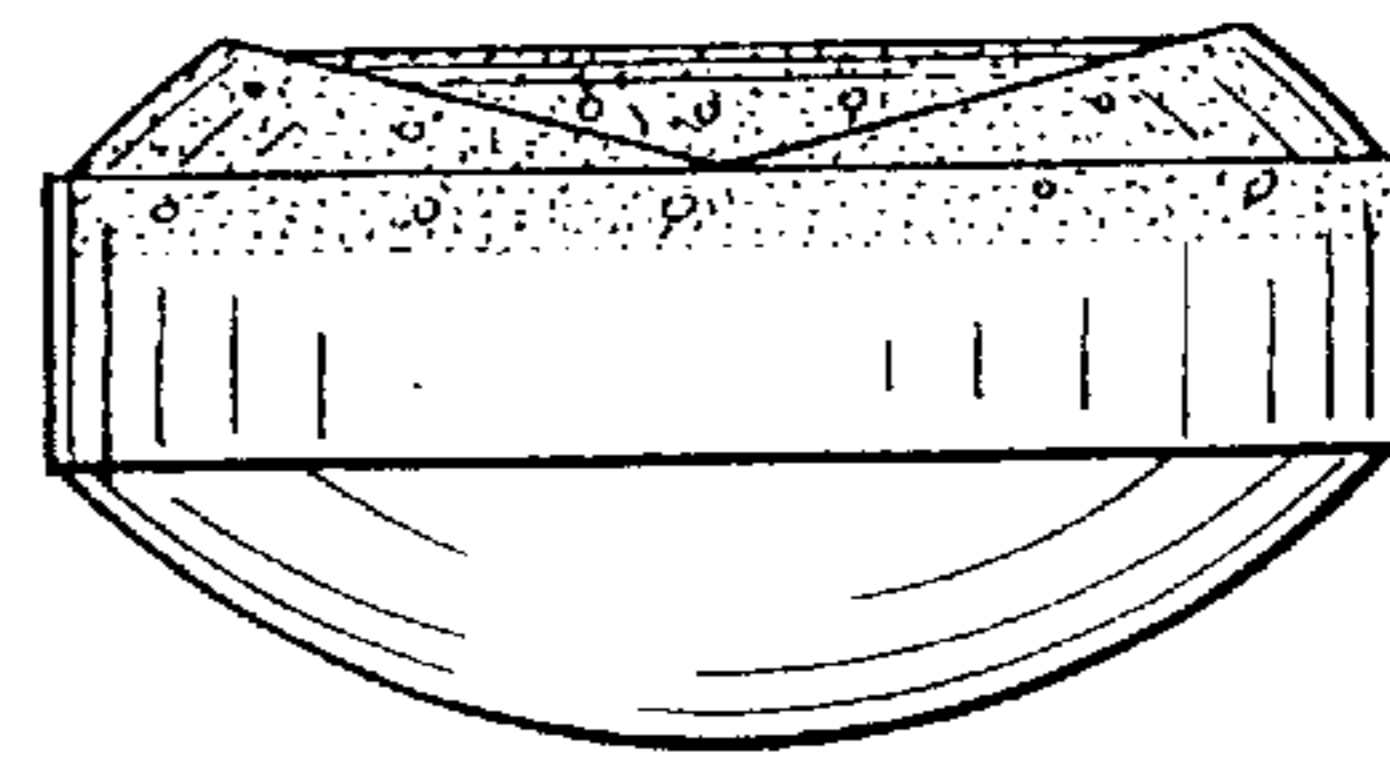

FIG. 2

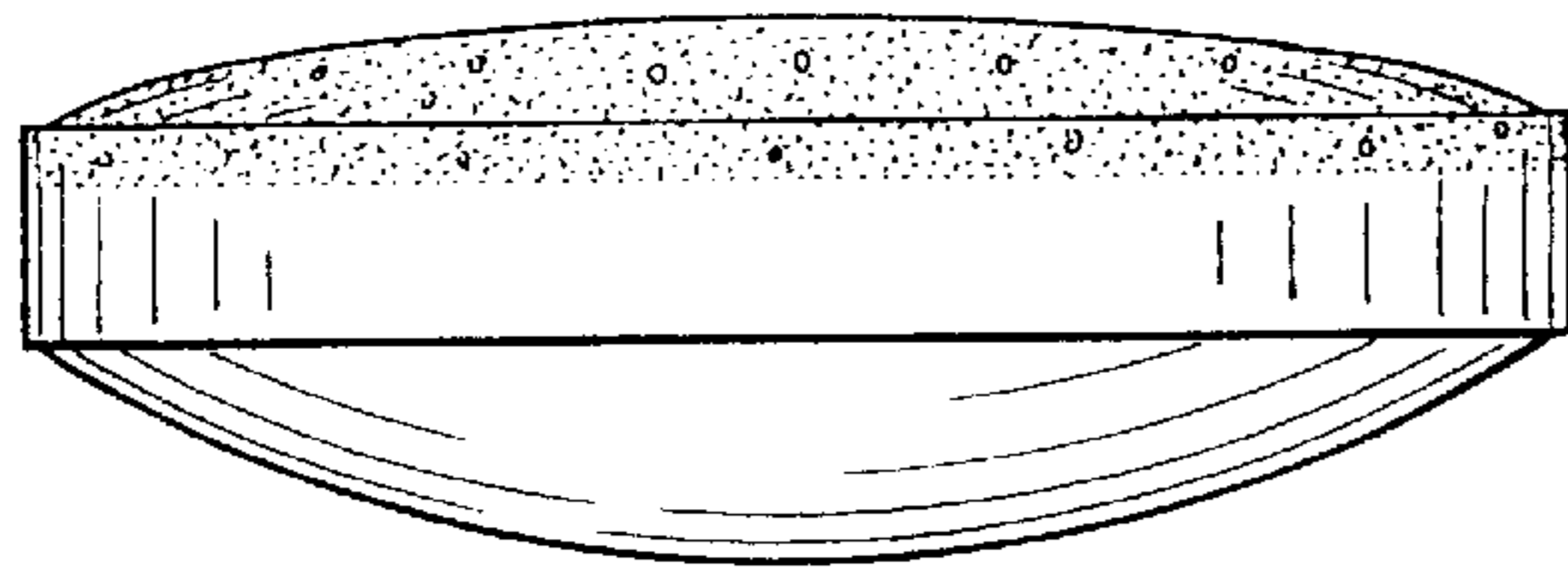

FIG. 3

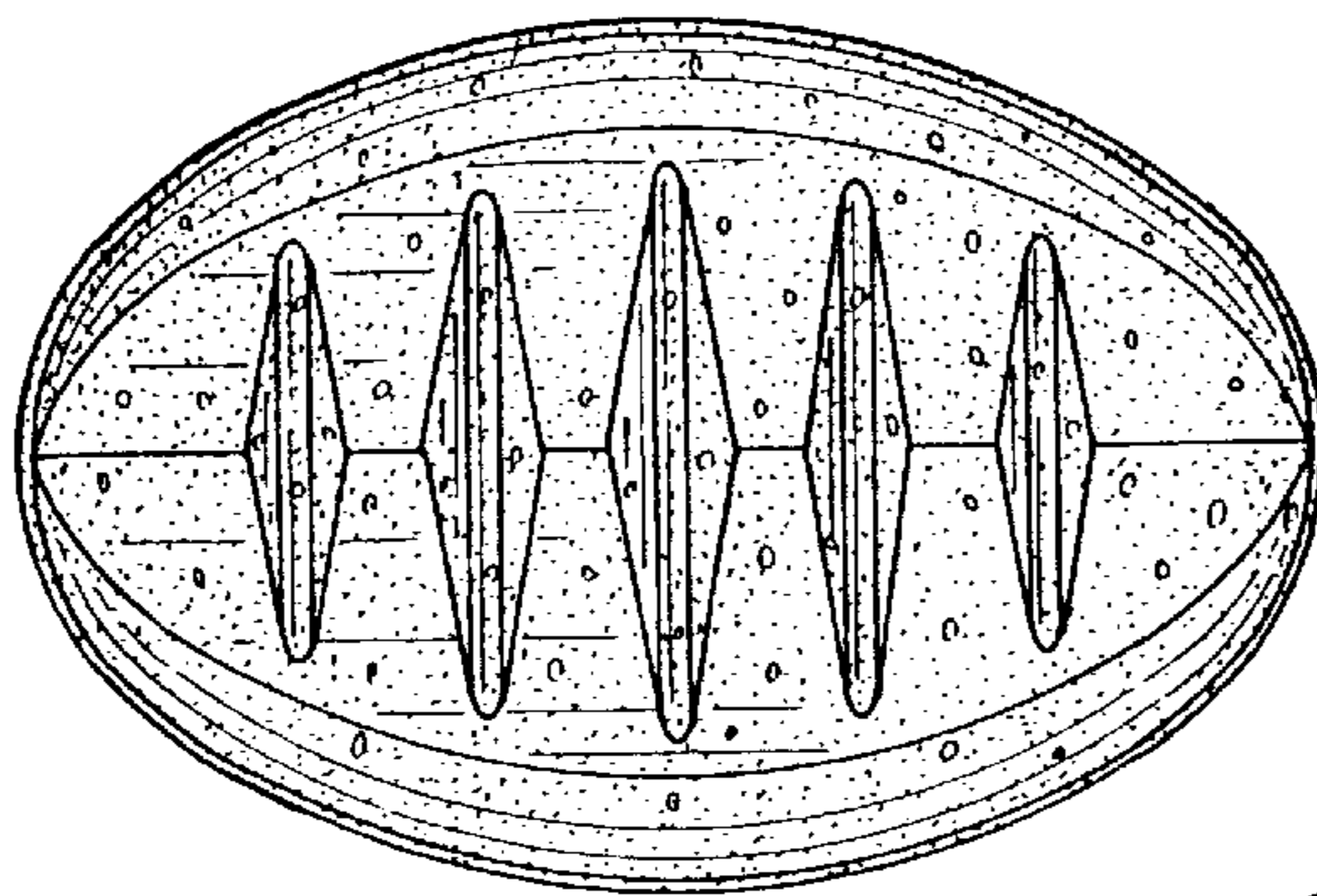

FIG. 4

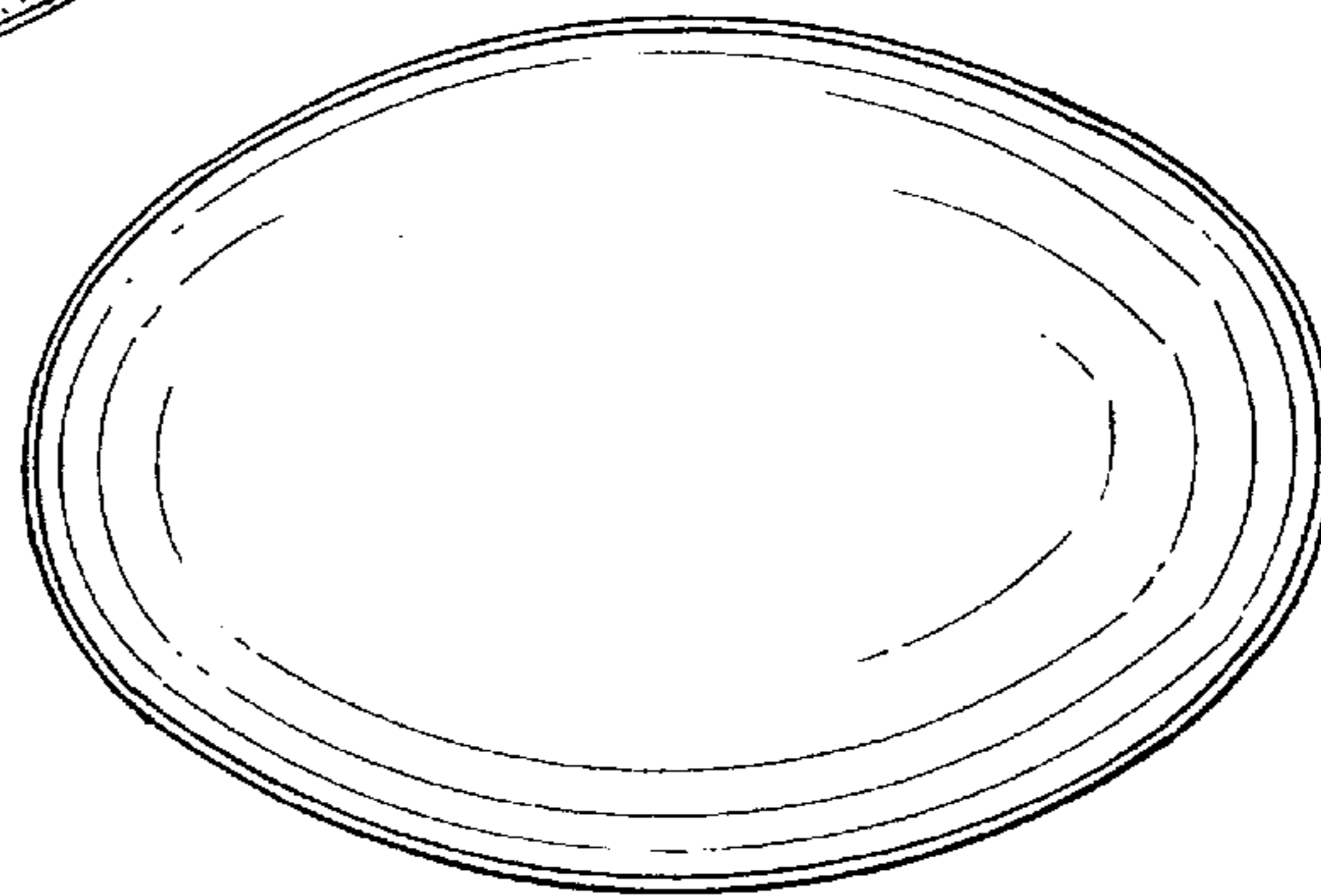

FIG. 5

FIG. 6

