



US00D535379S

(12) **United States Design Patent**
Hundertmark

(10) **Patent No.:** **US D535,379 S**

(45) **Date of Patent:** **** Jan. 16, 2007**

(54) **AIR FRESHENER**

(75) Inventor: **Volker Hundertmark**, Raddestorf (DE)

(73) Assignee: **Henkel Kommanditgesellschaft auf Aktien (Henkel KGaA)**, Dusseldorf (DE)

(**) Term: **14 Years**

(21) Appl. No.: **29/253,592**

(22) Filed: **Feb. 8, 2006**

Related U.S. Application Data

(62) Division of application No. 29/224,117, filed on Feb. 25, 2003, now abandoned.

(30) **Foreign Application Priority Data**

Aug. 25, 2004 (DE) 404 04 840

(51) **LOC (8) Cl.** **28-99**

(52) **U.S. Cl.** **D23/366**

(58) **Field of Classification Search** None
See application file for complete search history.

(56) **References Cited**

U.S. PATENT DOCUMENTS

| | | | | |
|-------------|---------|-------------------------|-------|---------|
| 3,780,260 A | 12/1973 | Elsner | | 392/392 |
| 5,926,614 A | 7/1999 | Steinel | | 392/392 |
| D430,659 S | 9/2000 | Zaragoza et al. | | D23/367 |
| D432,222 S | 10/2000 | Rymer et al. | | D23/366 |
| D433,744 S | 11/2000 | Basaganas | | D23/366 |
| D437,636 S | 2/2001 | Basaganas | | D23/366 |
| D465,019 S | 10/2002 | Wu | | D23/366 |
| D474,268 S | 5/2003 | Choke-arpornchai et al. | | D23/366 |
| D476,070 S | 6/2003 | Basaganas Millan | | D23/366 |

| | | | | |
|-----------------|---------|------------------|-------|---------|
| 6,850,697 B1 | 2/2005 | Basaganas Millan | | 392/390 |
| 2002/0076214 A1 | 6/2002 | Vieira | | 392/395 |
| 2003/0231876 A1 | 12/2003 | Basaganas Millan | | 392/390 |

Primary Examiner—Sandra S. Snapp

(57) **CLAIM**

The ornamental design for an air freshener, as shown and described.

DESCRIPTION

FIG. 1 is a top right rear perspective view of an air freshener according to the new design in the closed position; FIG. 2 is a front elevation view thereof; FIG. 3 is a rear elevation view thereof; FIG. 4 is a right elevation view thereof; FIG. 5 is a left elevation view thereof; FIG. 6 is a top plan view thereof; FIG. 7 is a bottom plan view thereof; FIG. 8 is a top right rear perspective view of an air freshener according to the new design in the open position; FIG. 9 is a front elevation view thereof; FIG. 10 is a rear elevation view thereof; FIG. 11 is a right elevation view thereof; FIG. 12 is a left elevation view thereof; FIG. 13 is a top plan view thereof; FIG. 14 is a bottom plan view thereof; FIG. 15 is a top right rear perspective view of an air freshener according to the new design in one partially opened position; FIG. 16 is a front elevation view thereof; FIG. 17 is a rear elevation view thereof; FIG. 18 is a right elevation view thereof; FIG. 19 is a left elevation view thereof; FIG. 20 is a top plan view thereof; and, FIG. 21 is a bottom plan view thereof.

1 Claim, 12 Drawing Sheets

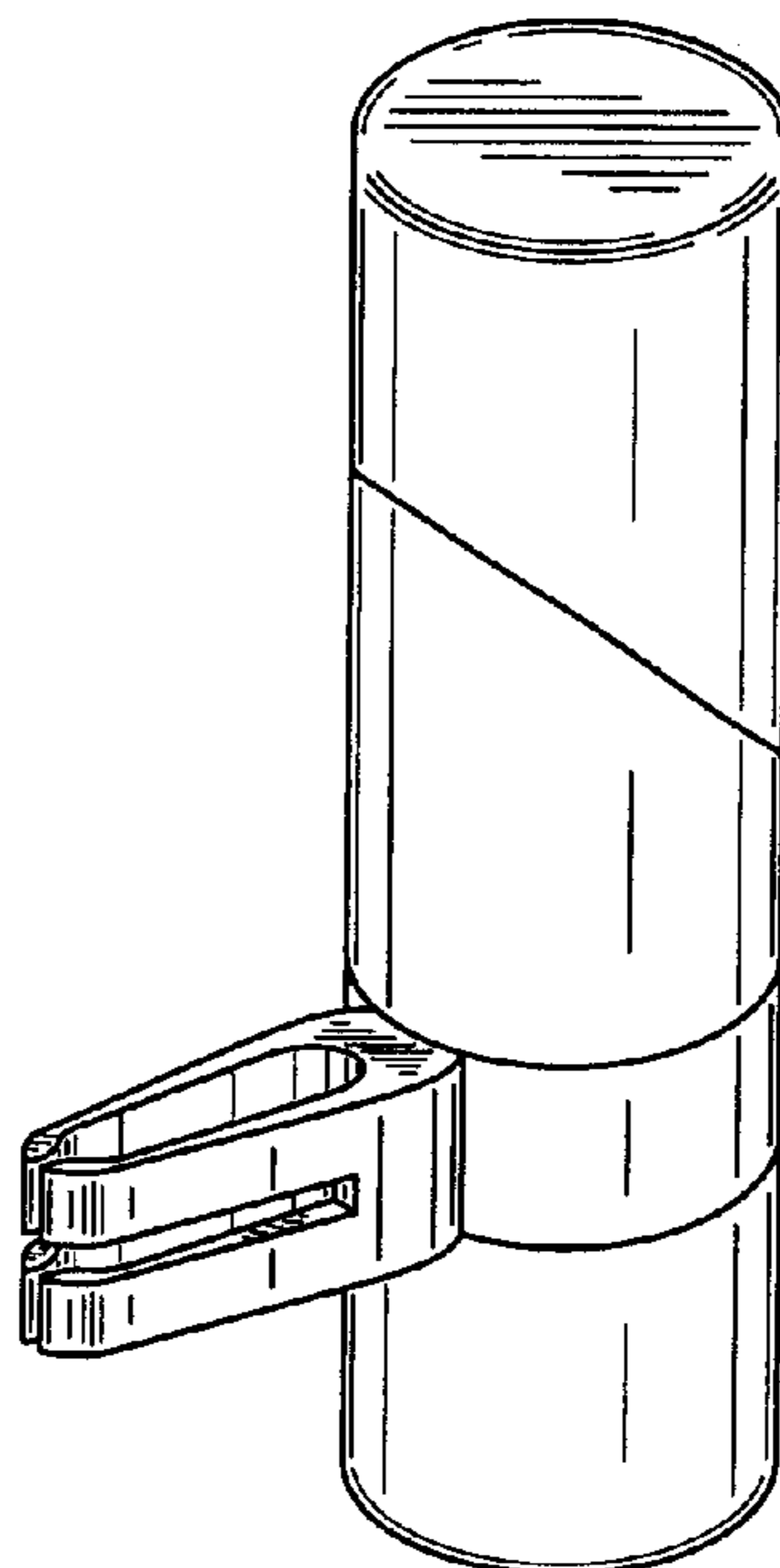

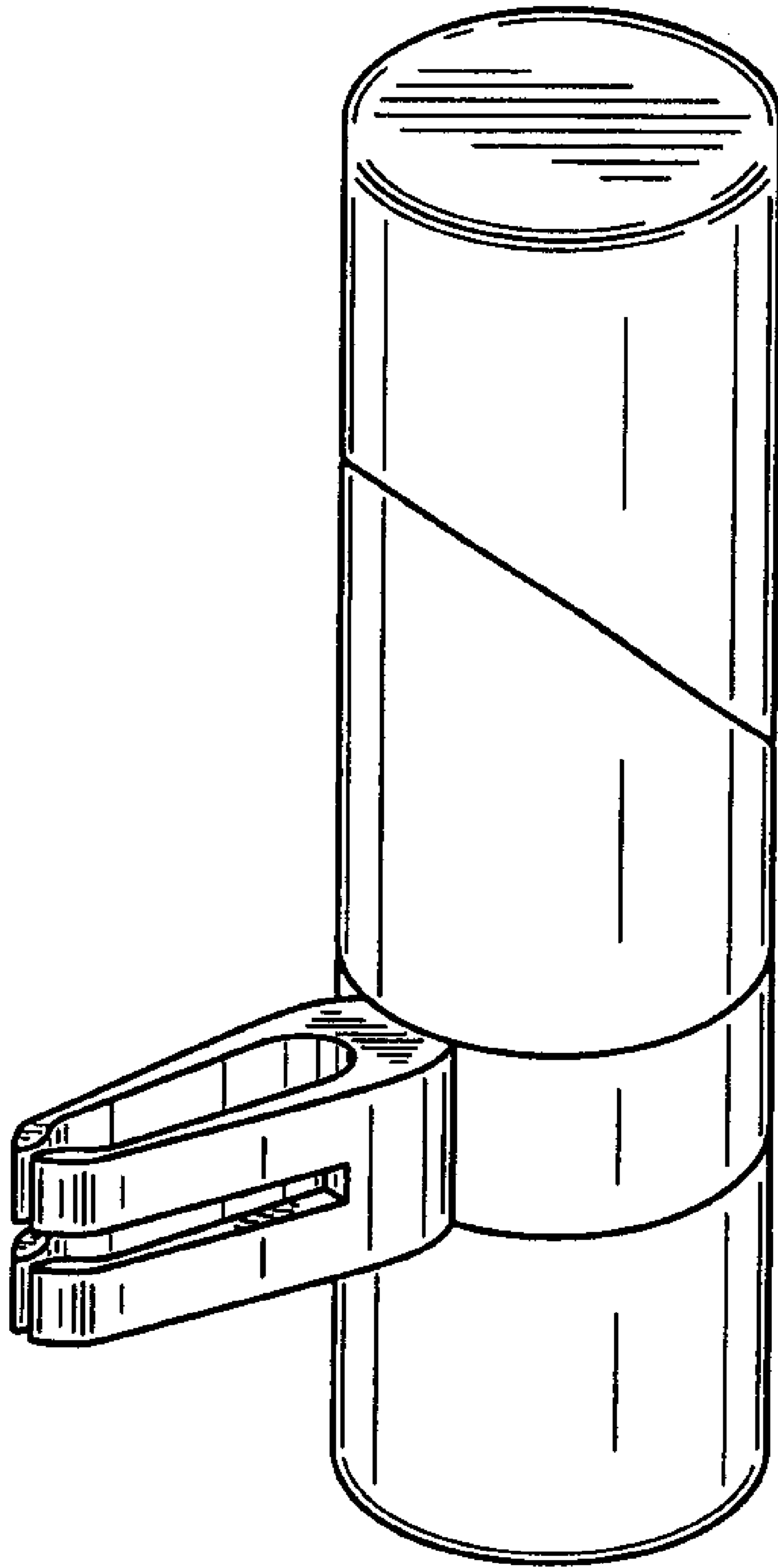

FIG. 1

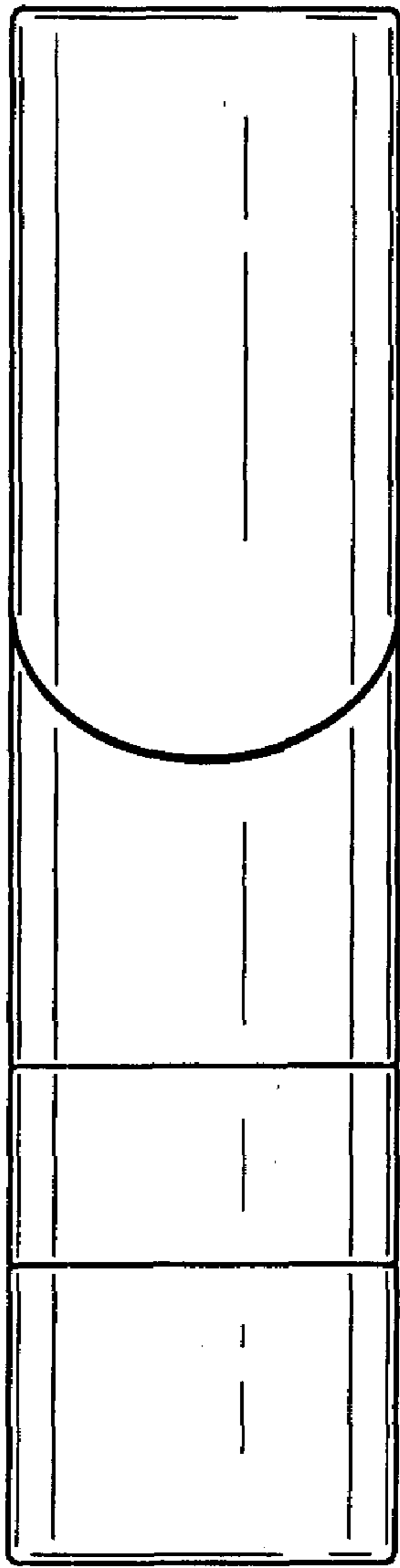

FIG. 2

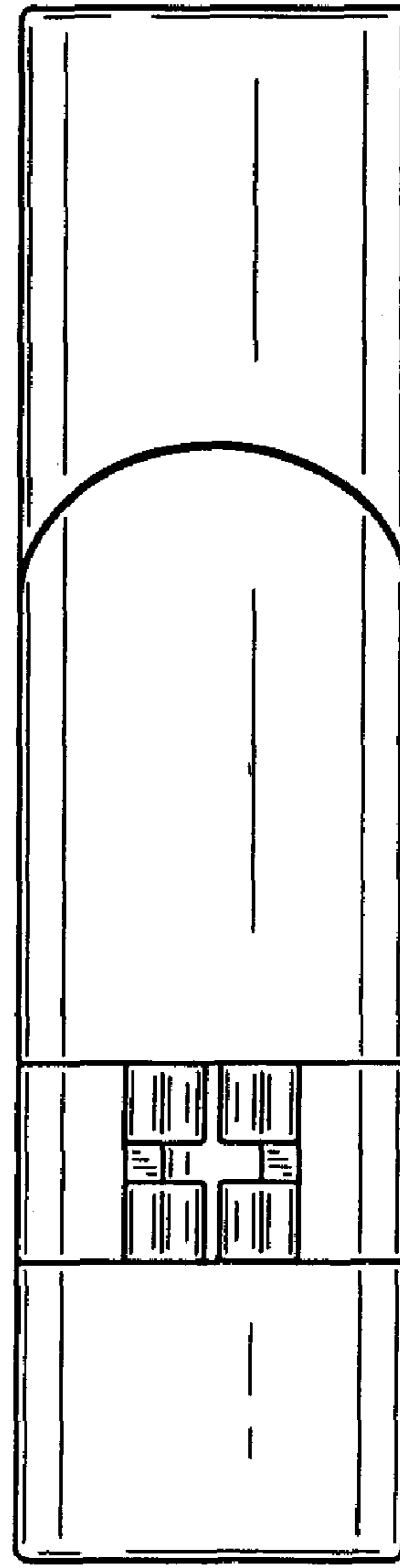

FIG. 3

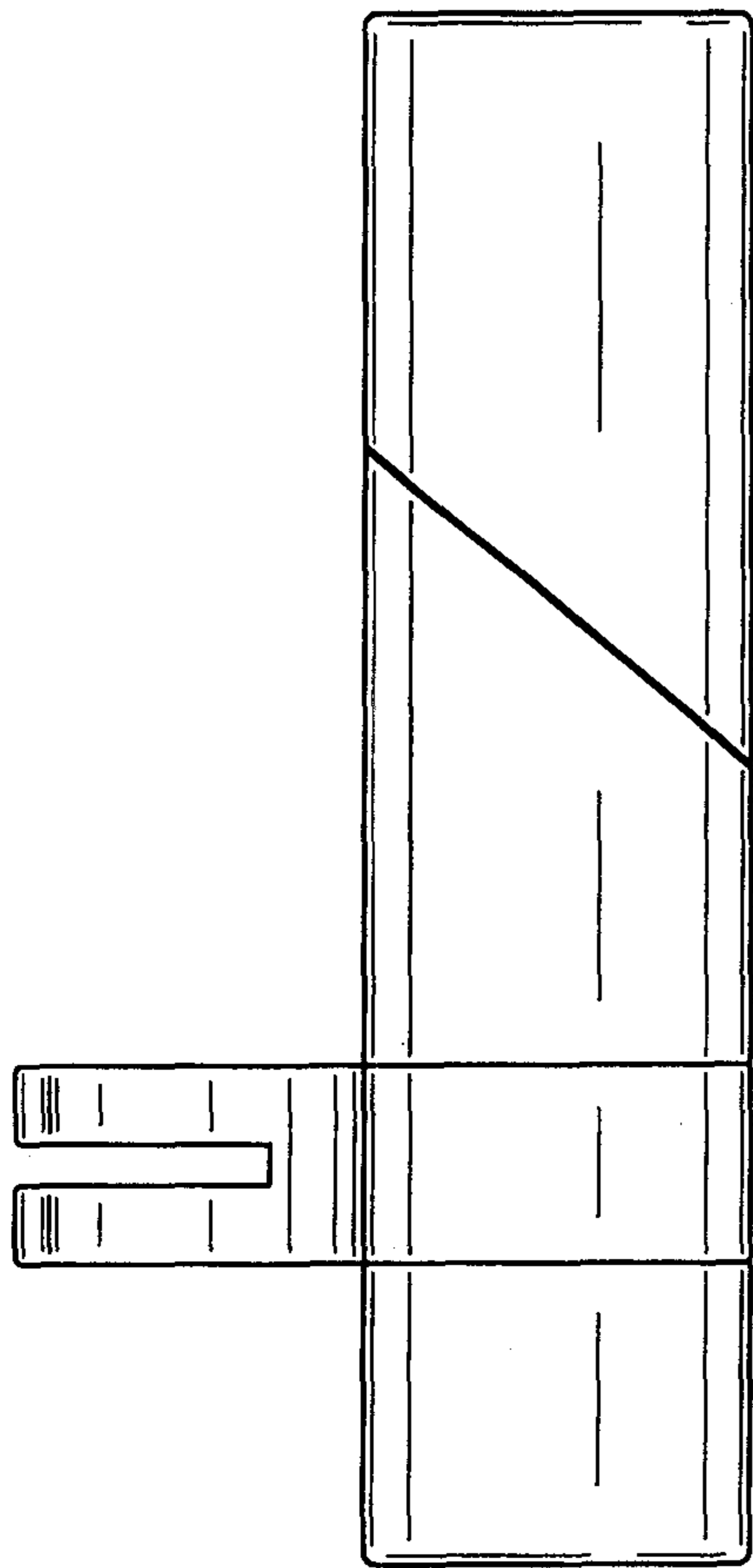

FIG. 4

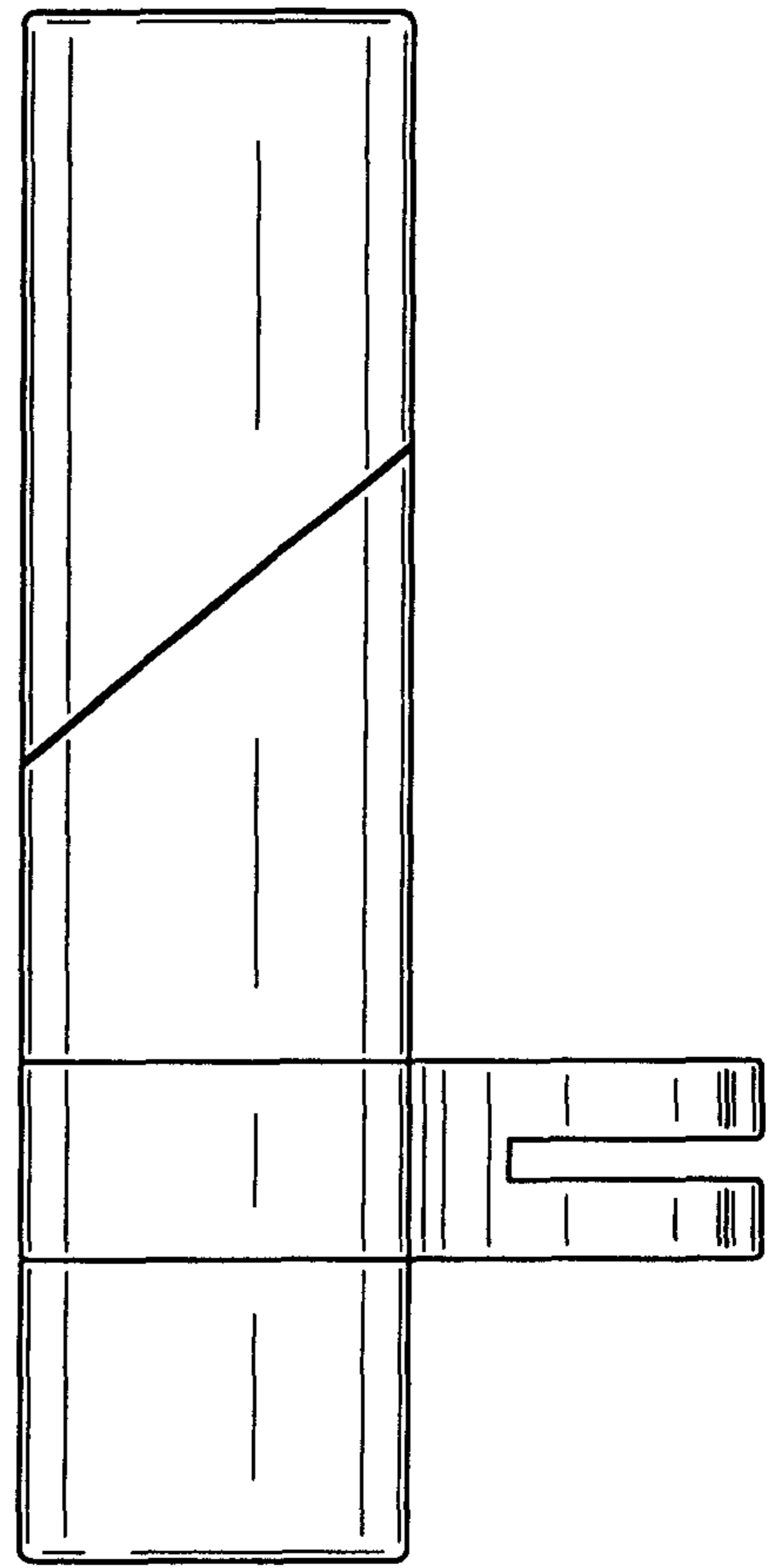

FIG. 5

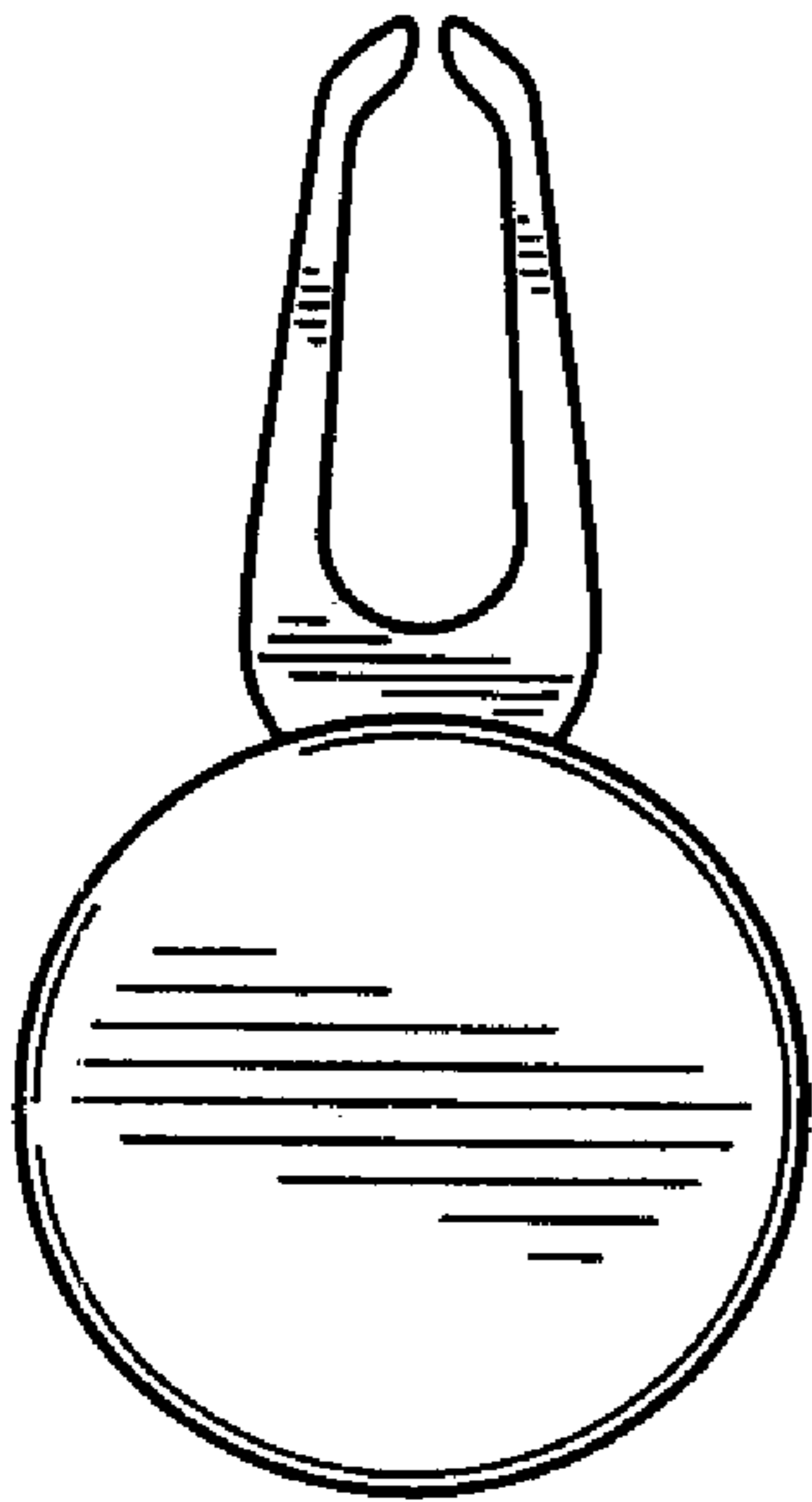

FIG. 6

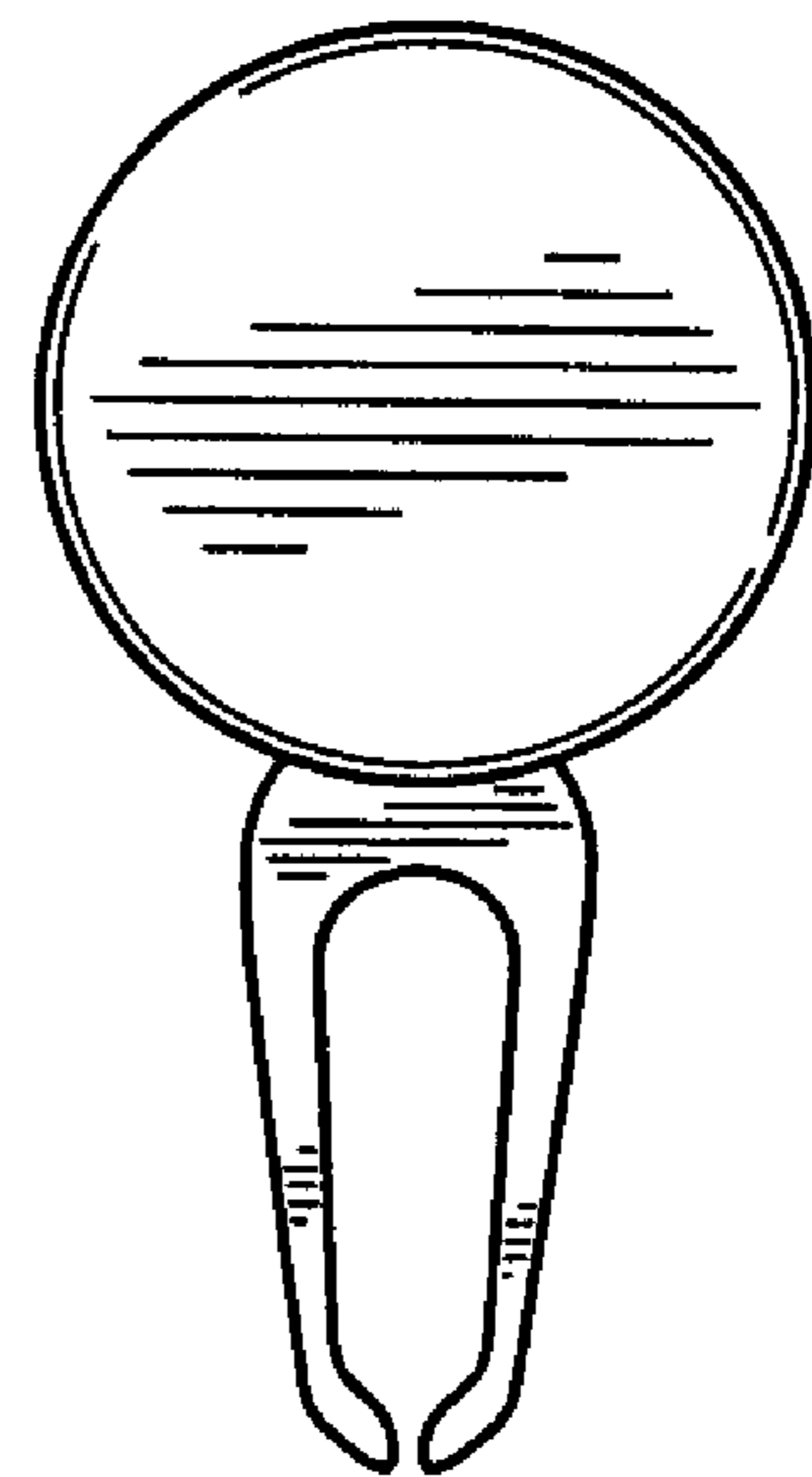

FIG. 7

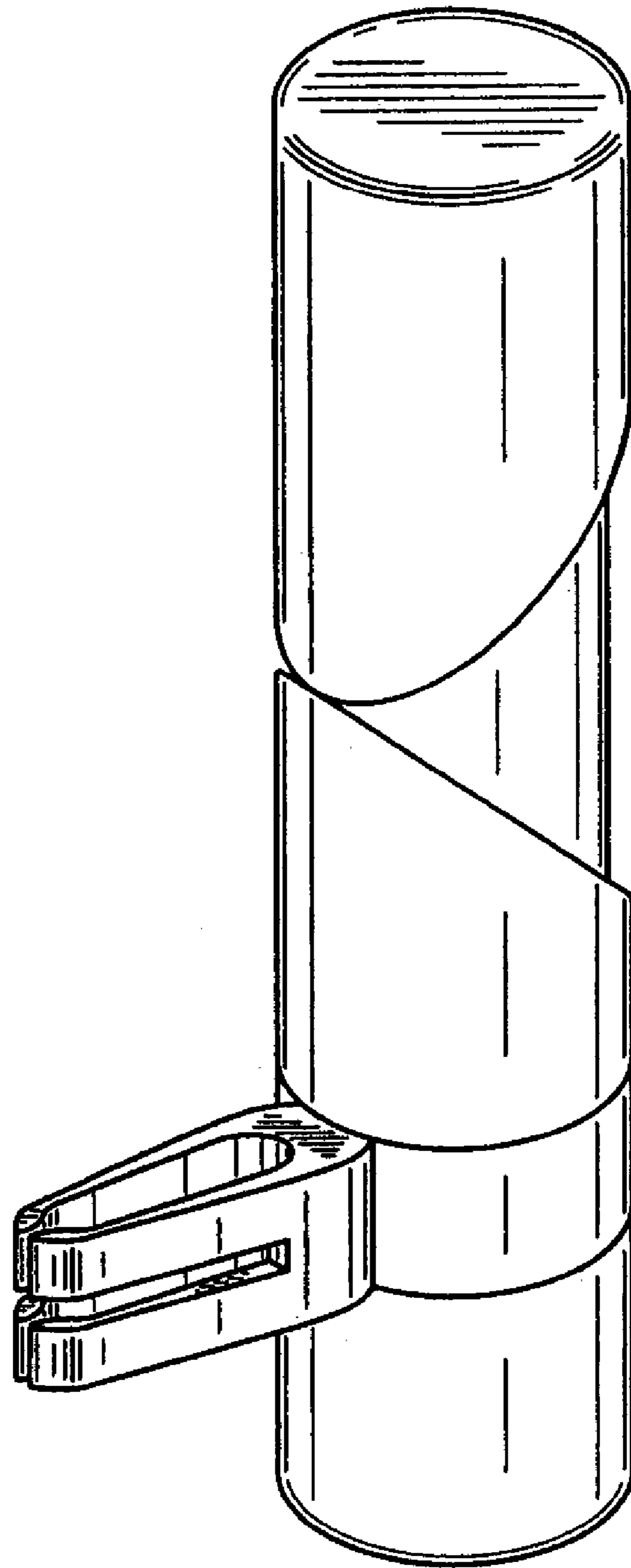

FIG. 8

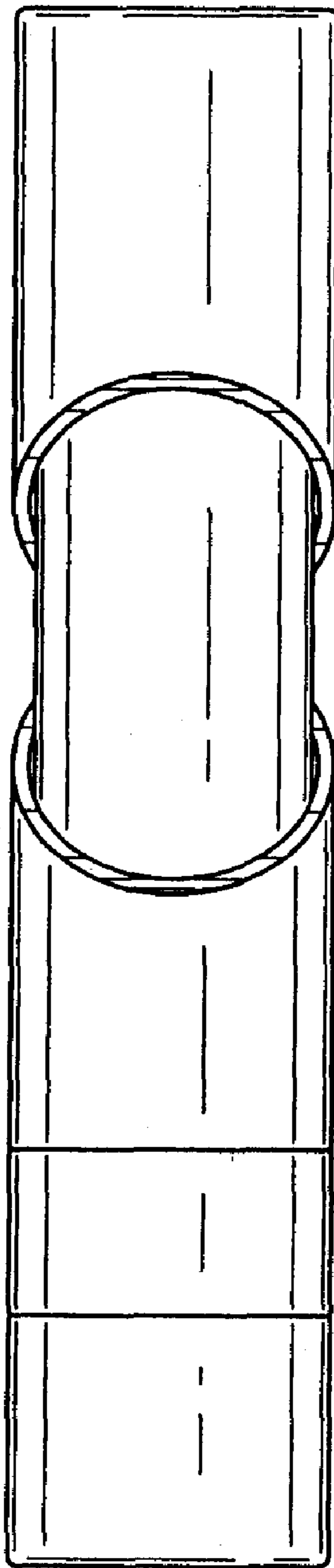

FIG. 9

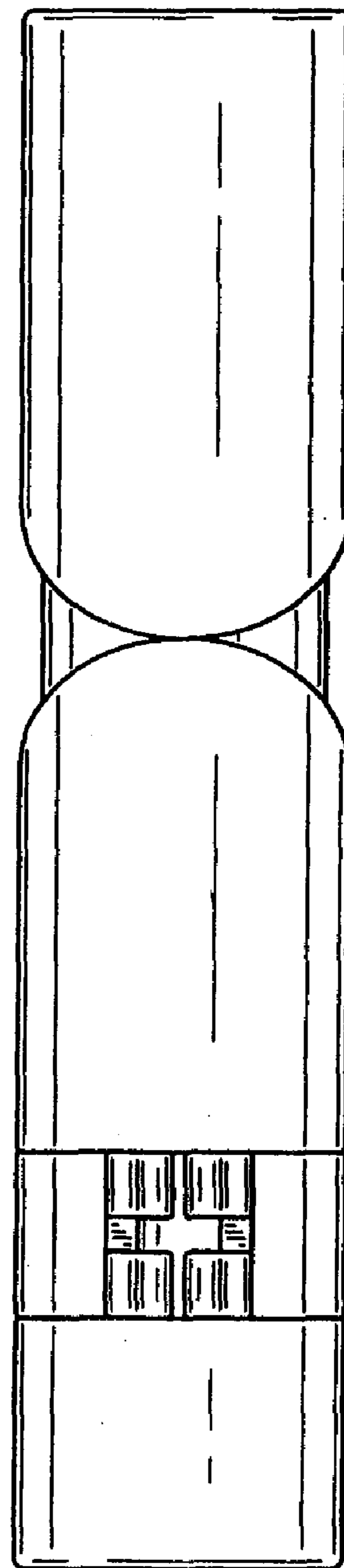

FIG. 10

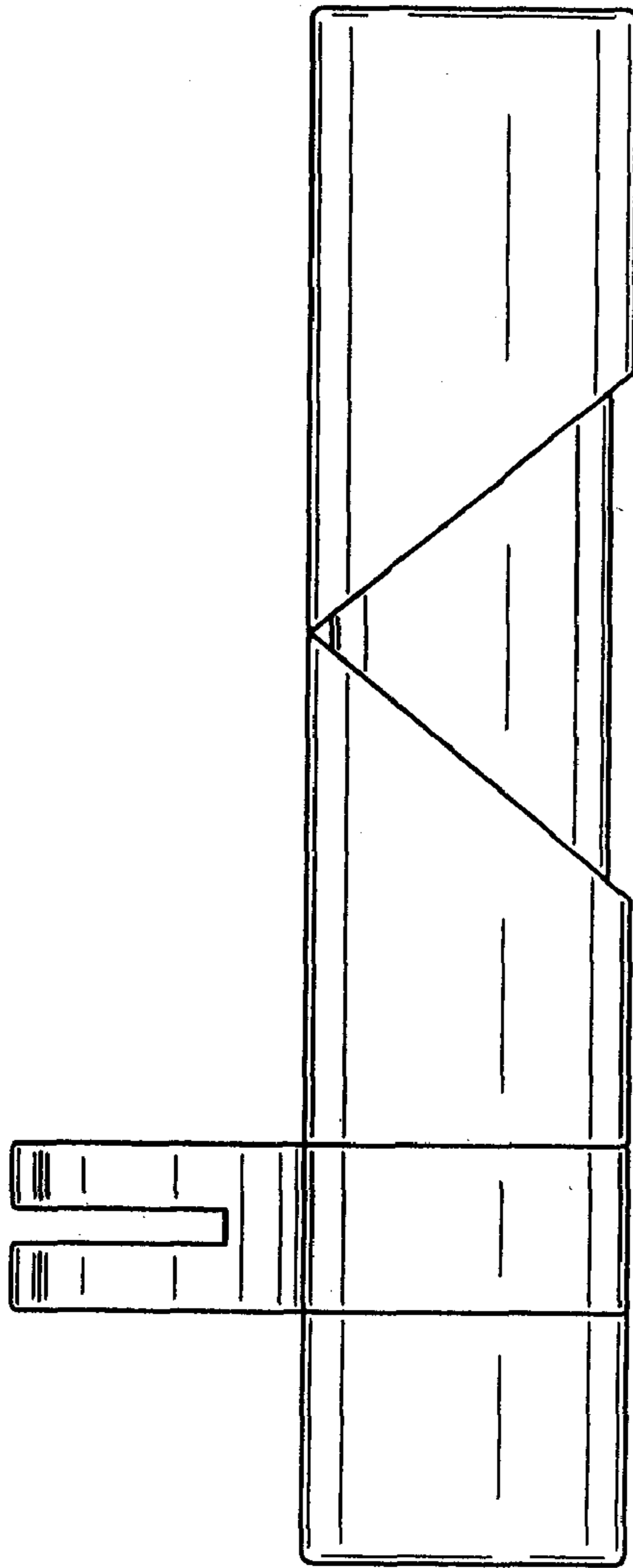

FIG. 11

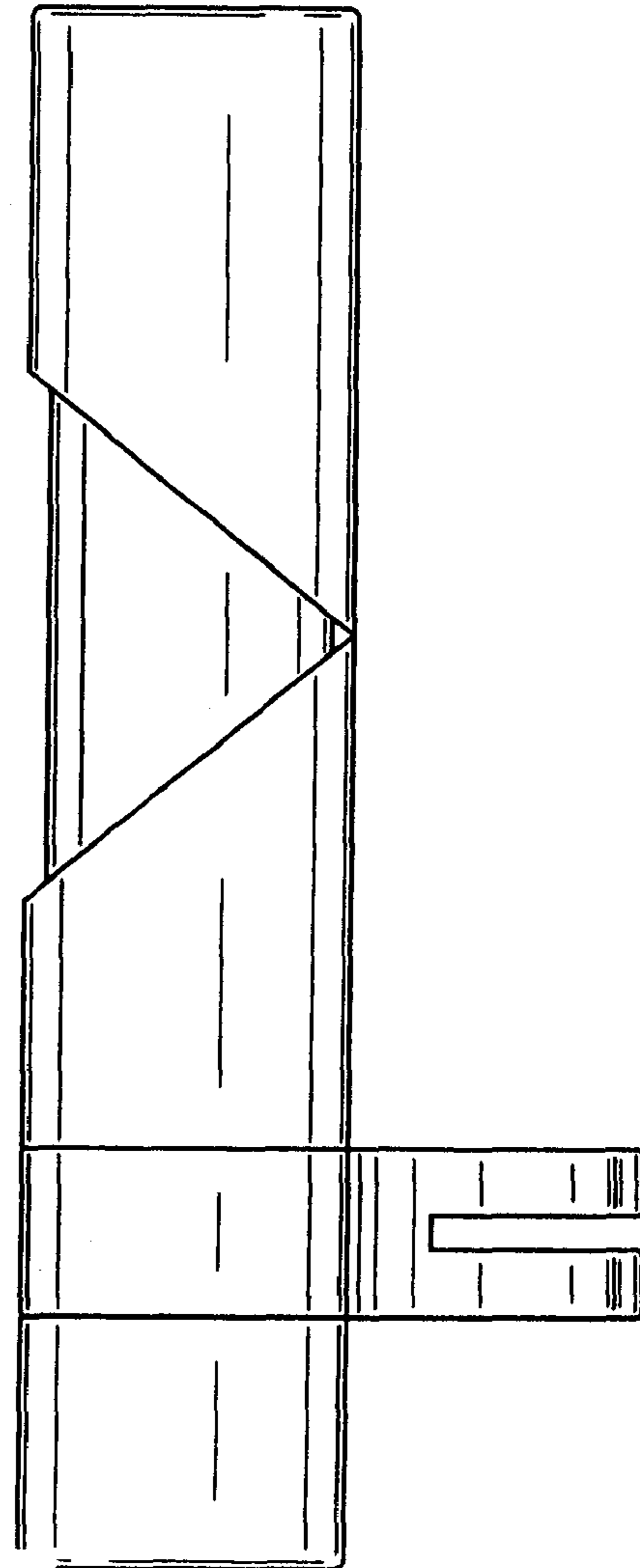

FIG. 12

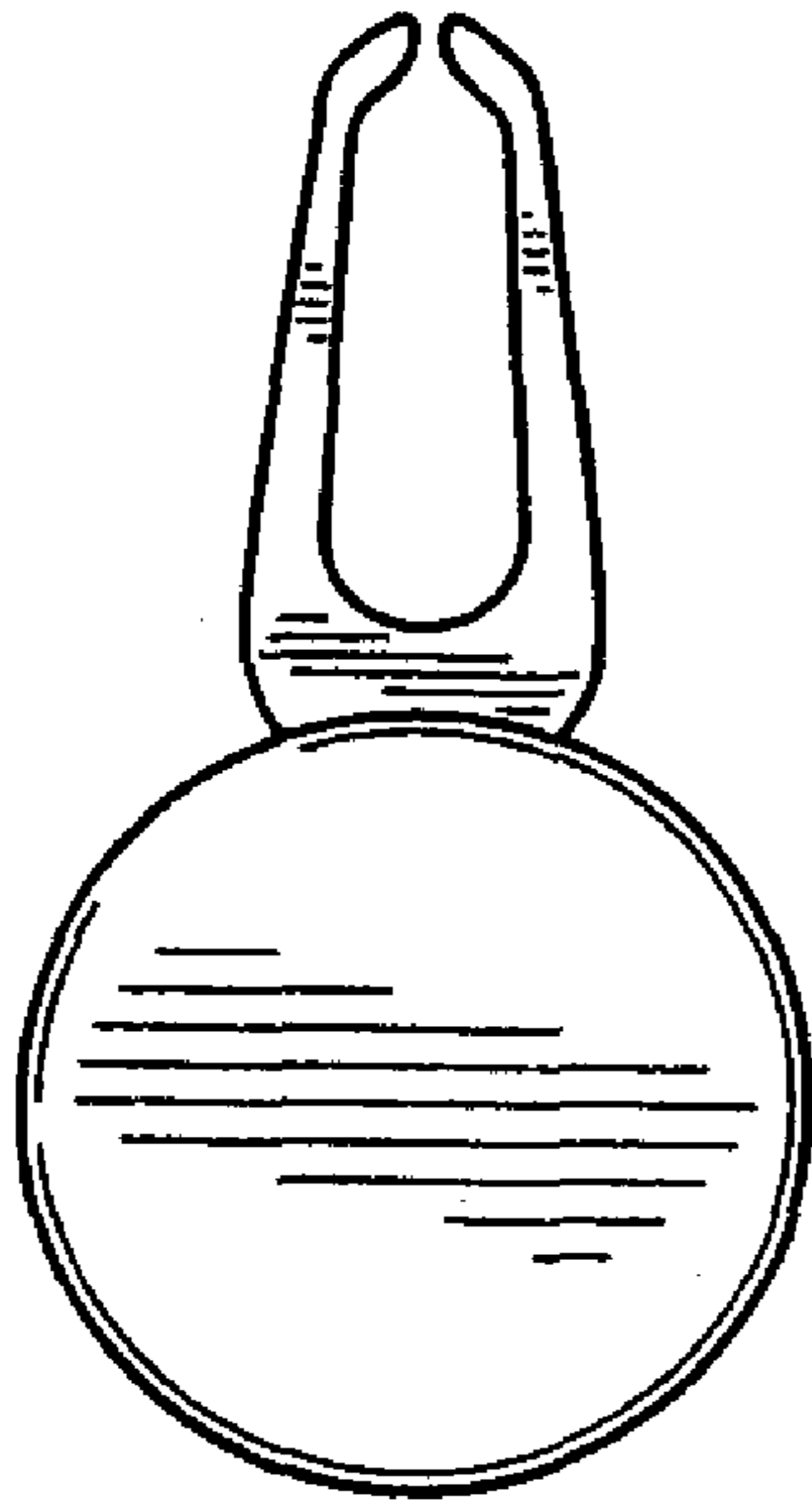

FIG. 13

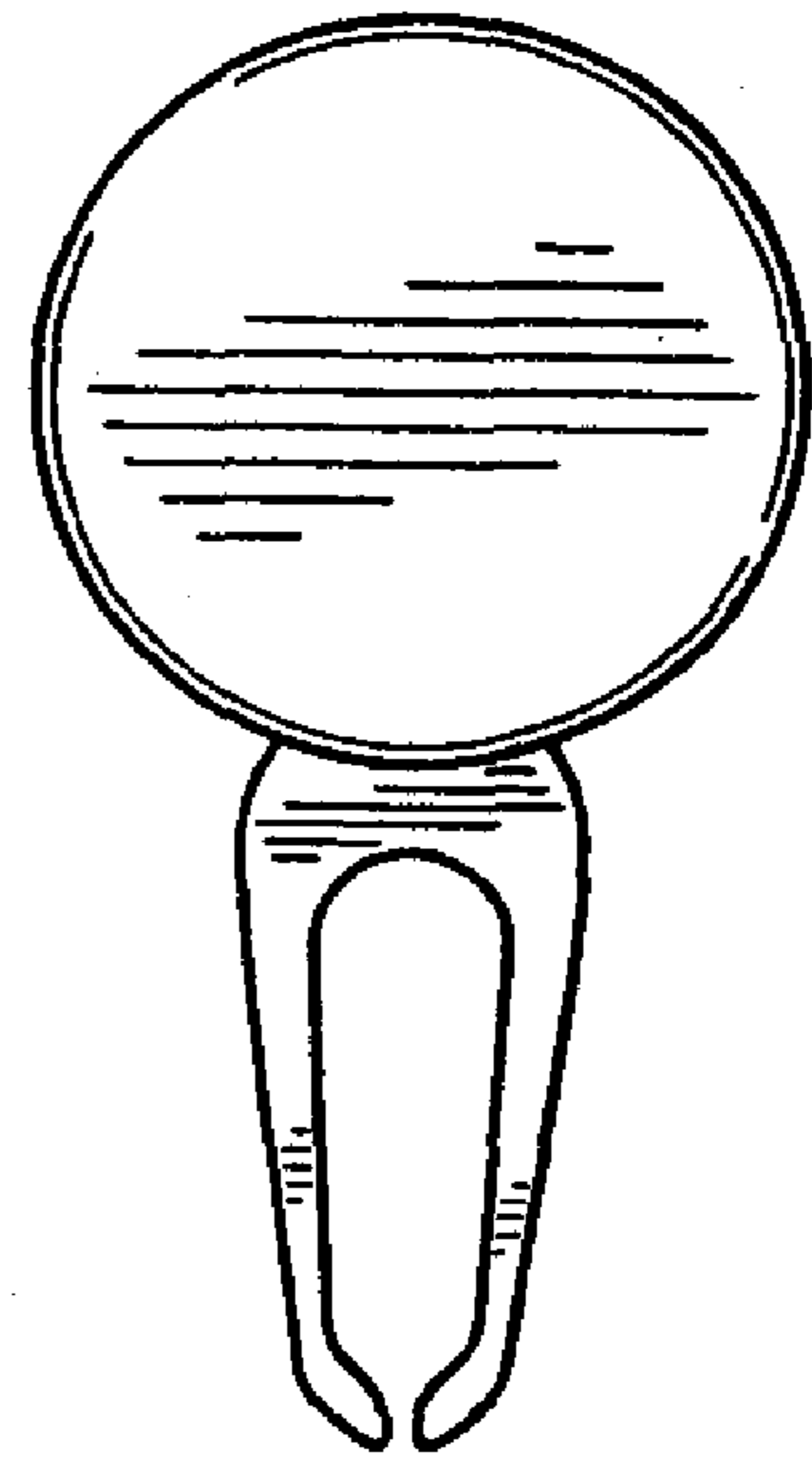

FIG. 14

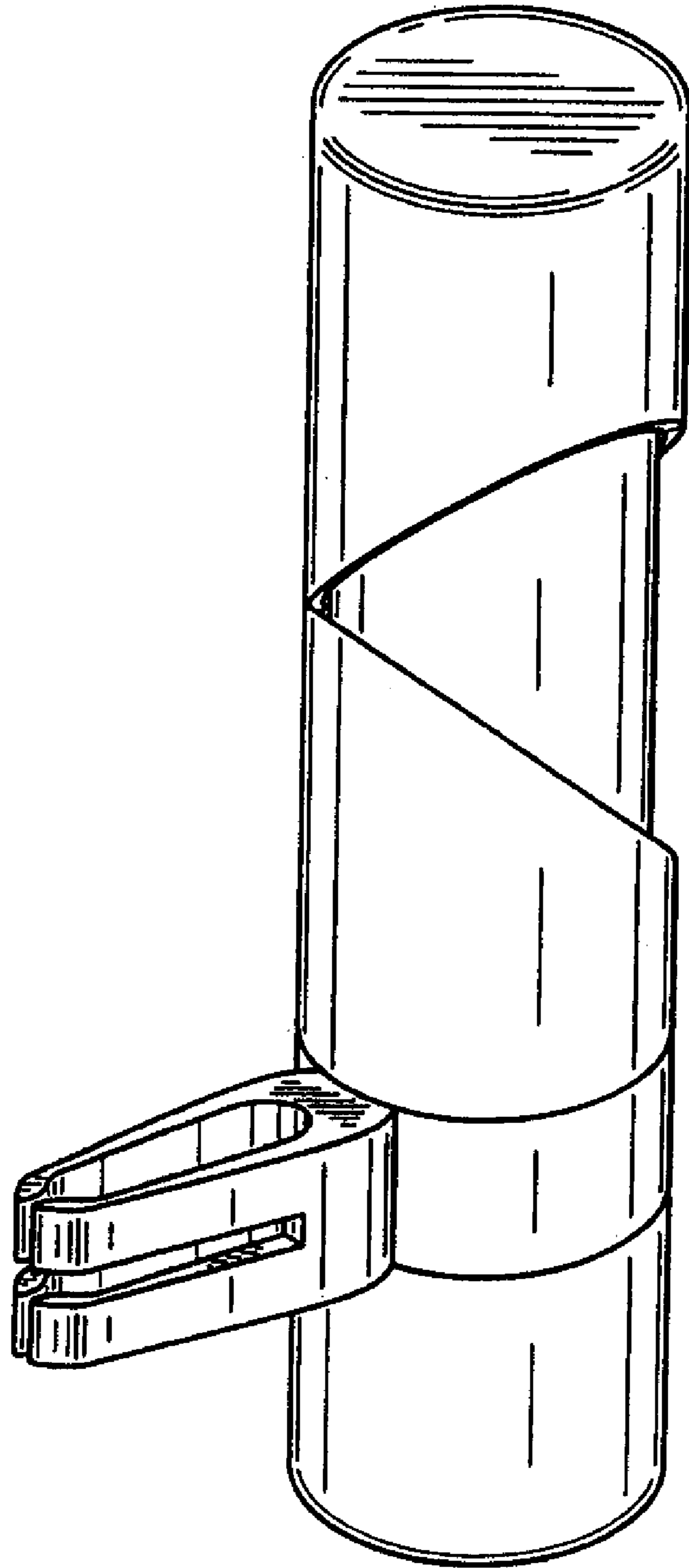

FIG. 15

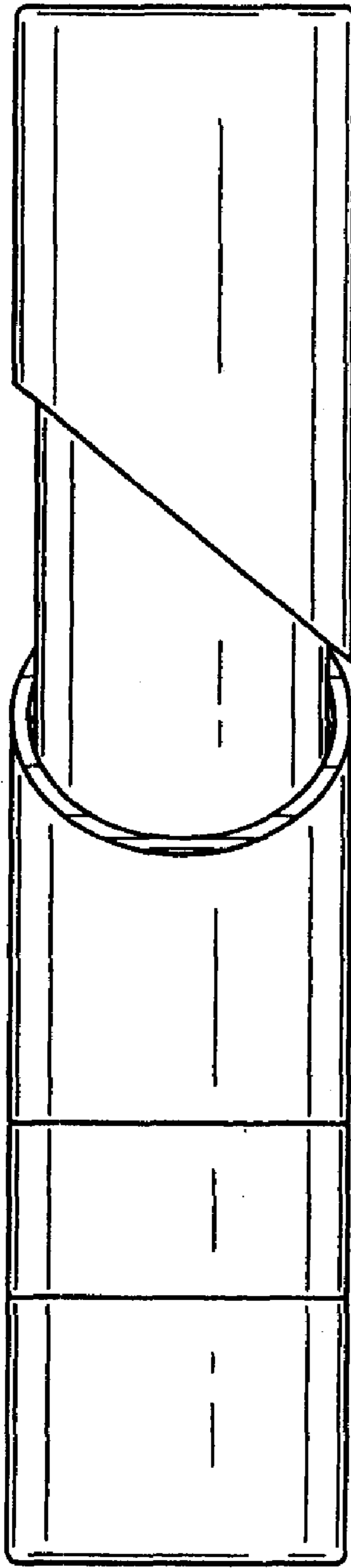

FIG. 16

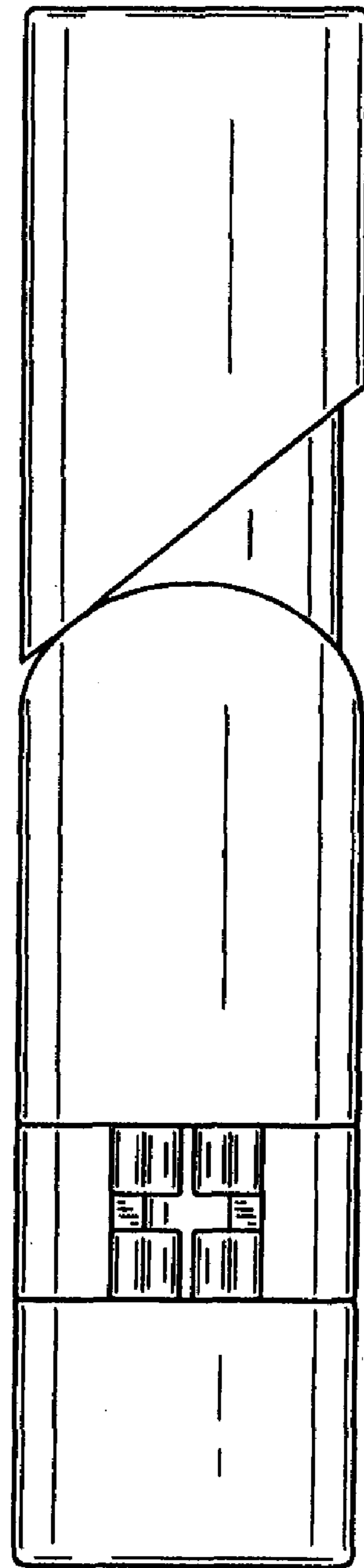

FIG. 17

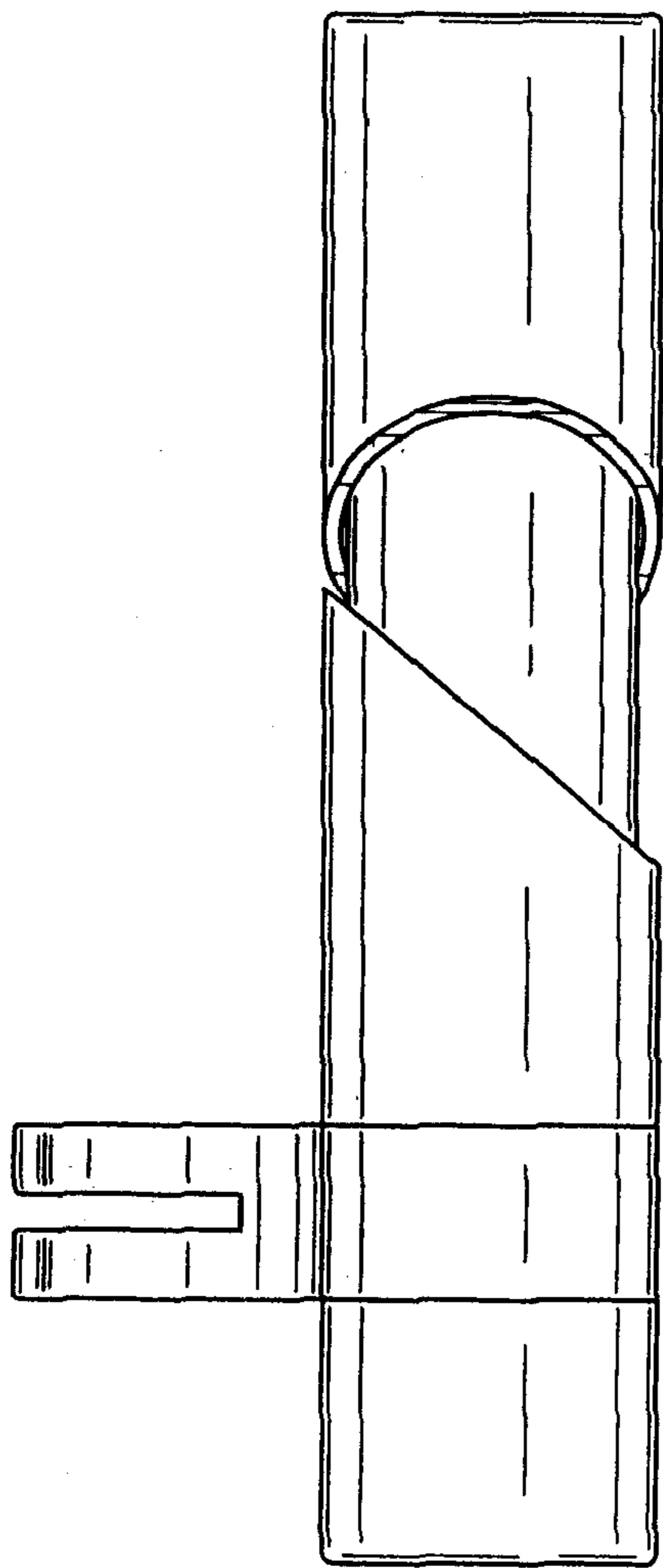

FIG. 18

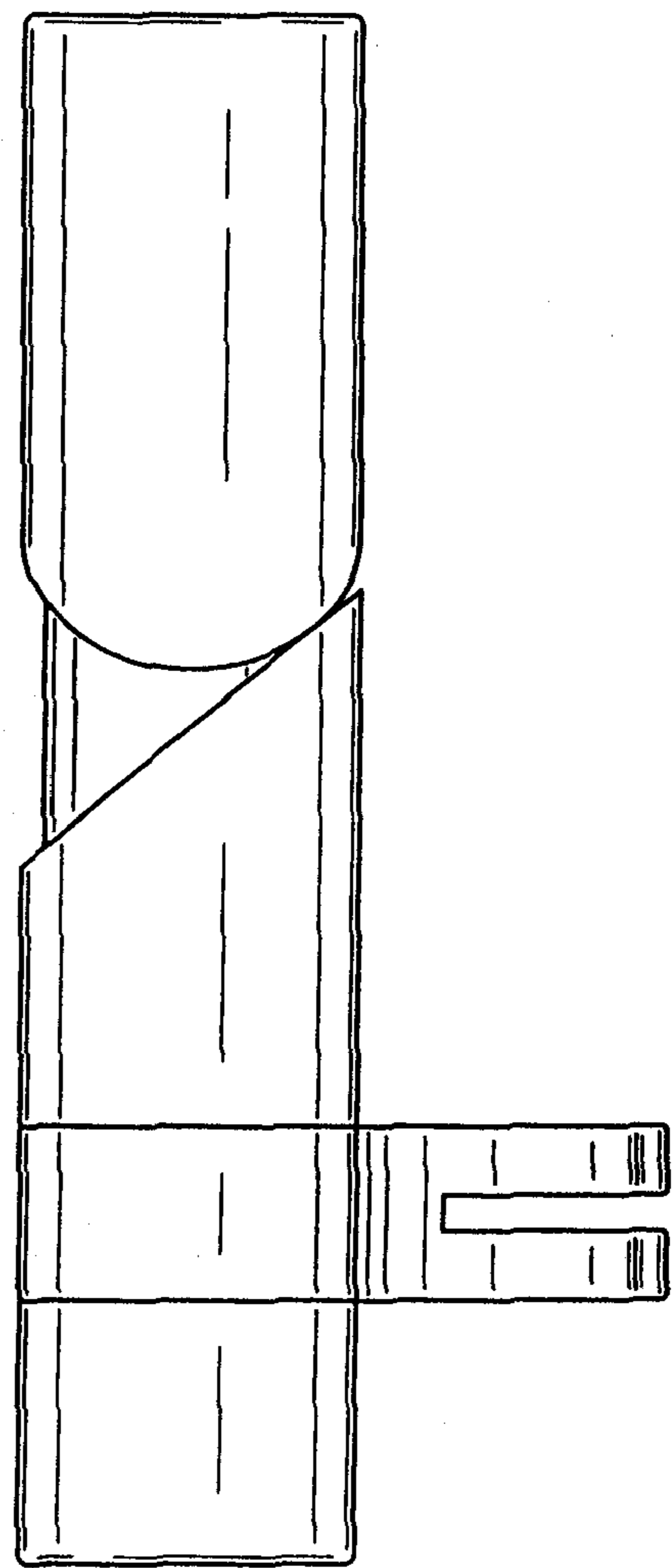

FIG. 19

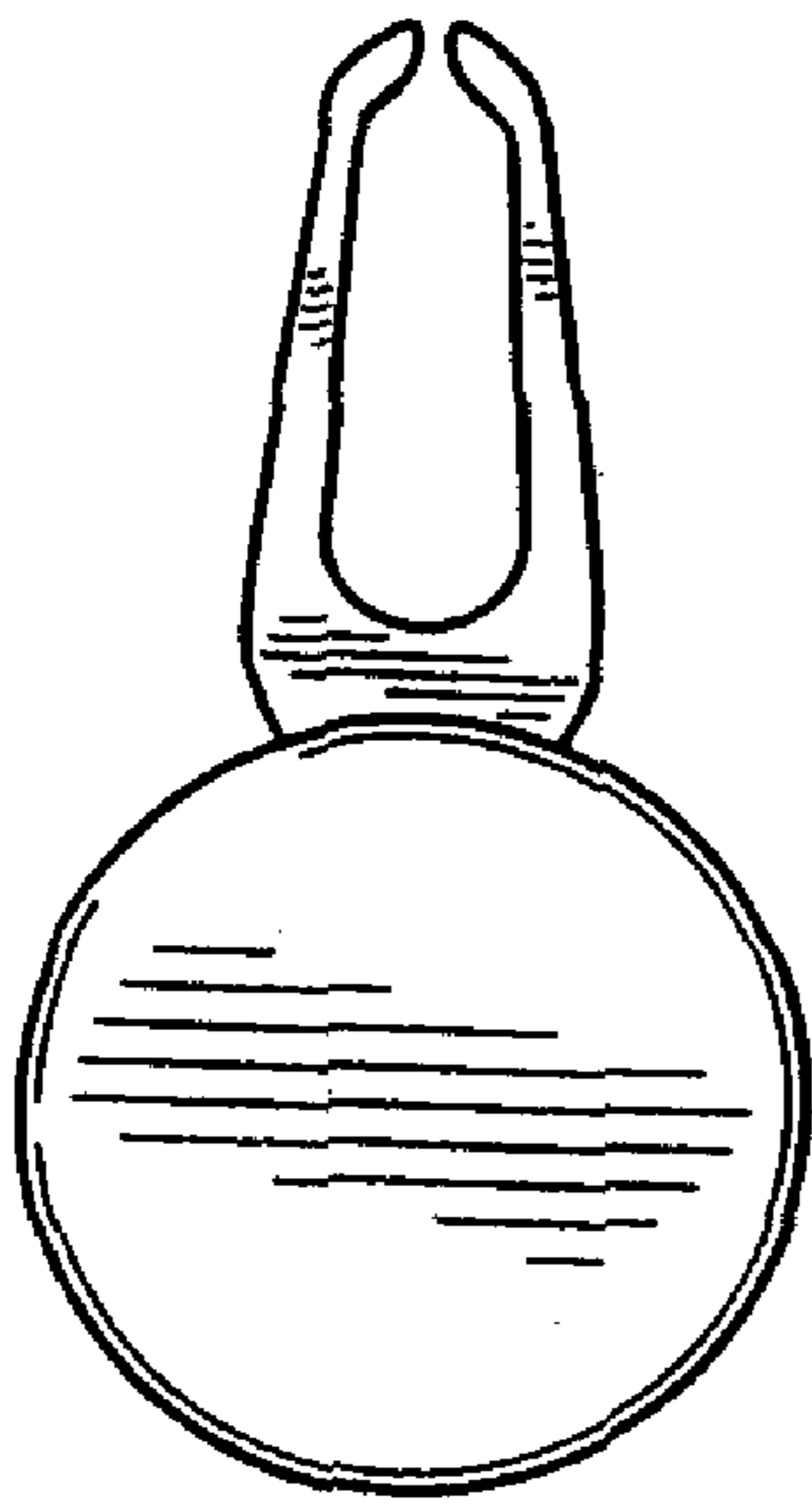

FIG. 20

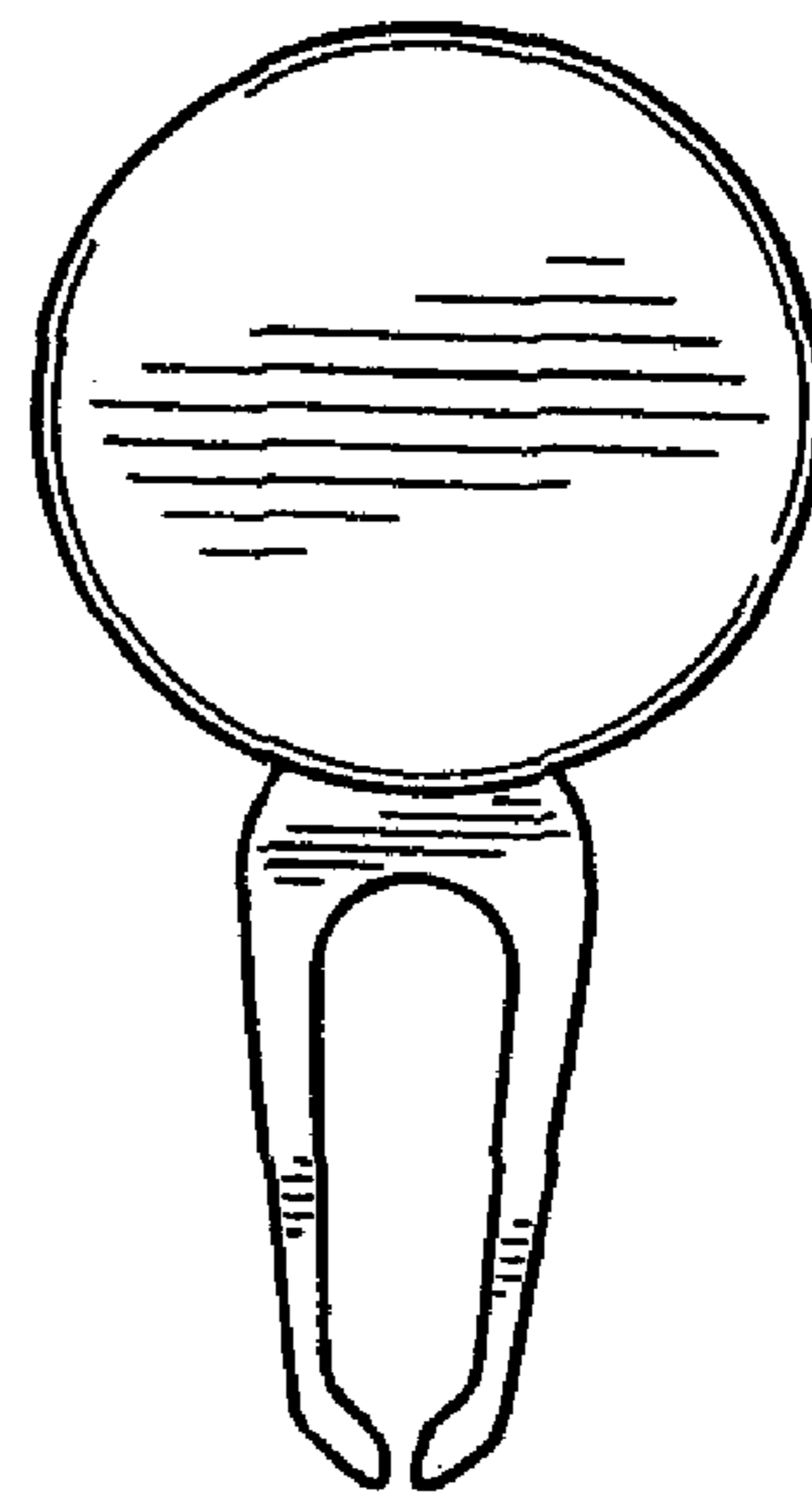

FIG. 21