



US00D535364S

(12) **United States Design Patent**  
**Gilbert**

(10) **Patent No.:** **US D535,364 S**

(45) **Date of Patent:** **\*\* Jan. 16, 2007**

(54) **HANDLE**

(75) **Inventor:** **Christopher Jon Gilbert**, Moreland Hills, OH (US)

(73) **Assignee:** **Moen Incorporated**

(\*\*) **Term:** **14 Years**

(21) **Appl. No.:** **29/258,452**

(22) **Filed:** **Apr. 20, 2006**

(51) **LOC (8) Cl.** ..... **23-01**

(52) **U.S. Cl.** ..... **D23/252**

(58) **Field of Classification Search** ..... D23/238-257;  
D8/250-257, 300-322, DIG. 3; 16/110.1;  
4/675-678; 137/801

See application file for complete search history.

(56) **References Cited**

**U.S. PATENT DOCUMENTS**

D175,819 S	10/1955	Young	
D355,578 S	2/1995	Mark et al.	
D378,984 S	4/1997	Carsello	
D392,721 S	3/1998	Doughty et al.	
D414,247 S	* 9/1999	Kolada et al. ....	D23/252
D416,609 S	11/1999	Mullenmeister	
D434,113 S	11/2000	Lord	
D443,917 S	6/2001	Lord	

D444,853 S	7/2001	Lord
D444,854 S	7/2001	Lord
D444,856 S	7/2001	Green et al.
D471,620 S	3/2003	Zhao
D482,760 S	11/2003	Fraser et al.
D505,714 S	5/2005	Dretzka
2004/0088786 A1 *	5/2004	Malek et al.

\* cited by examiner

*Primary Examiner*—Louis S. Zarfes

*Assistant Examiner*—Gregory Andoll

(74) *Attorney, Agent, or Firm*—Calfee, Halter & Griswold, LLP

(57) **CLAIM**

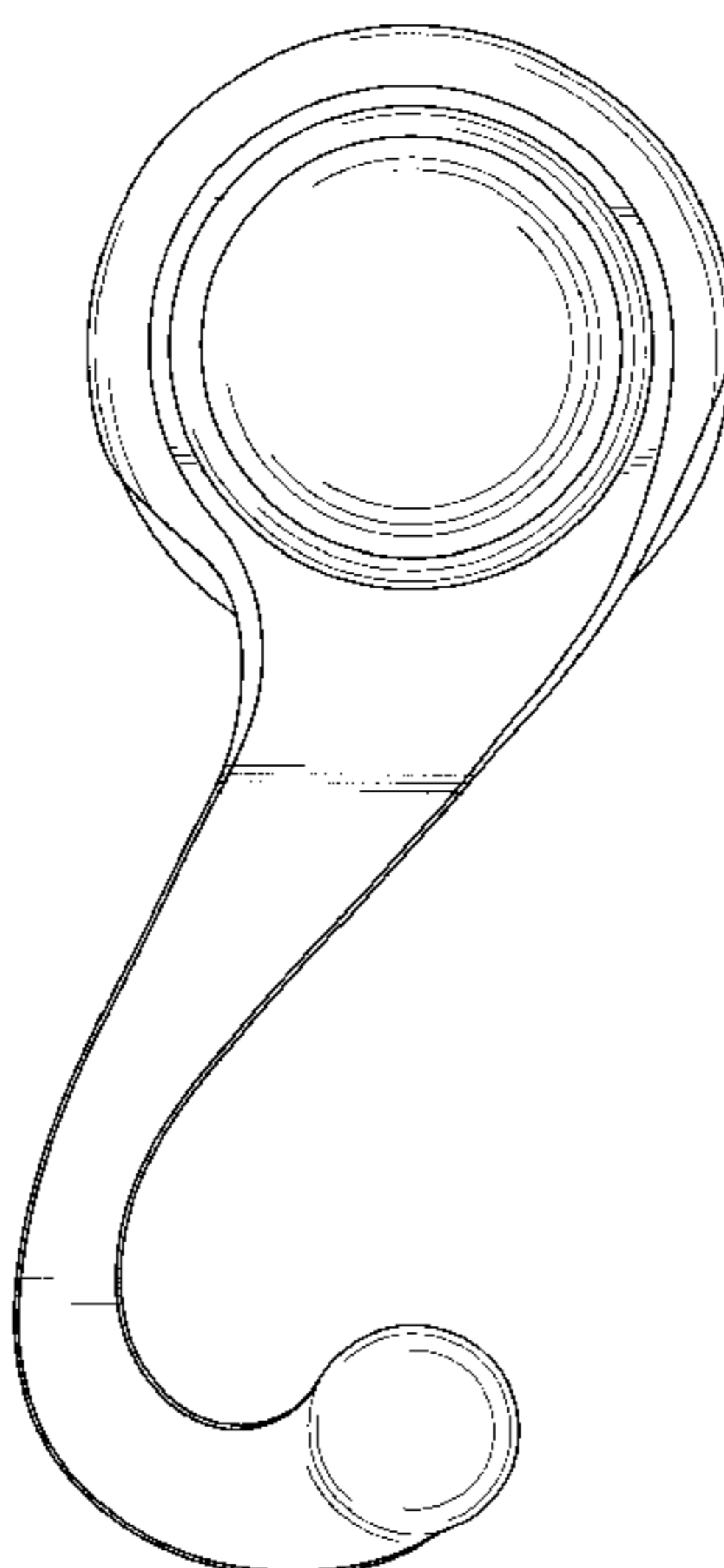
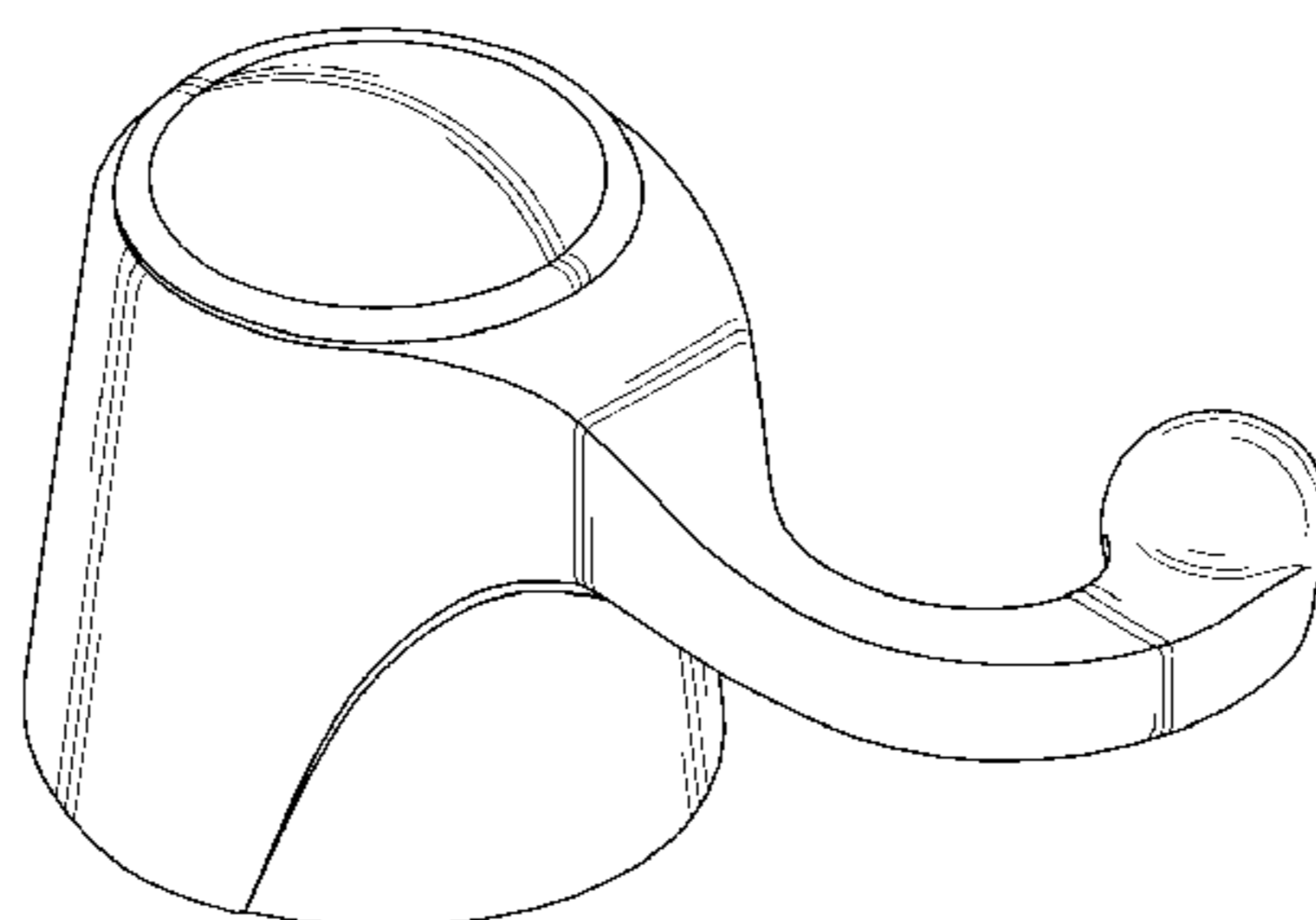
The ornamental design for a handle, as shown and described.

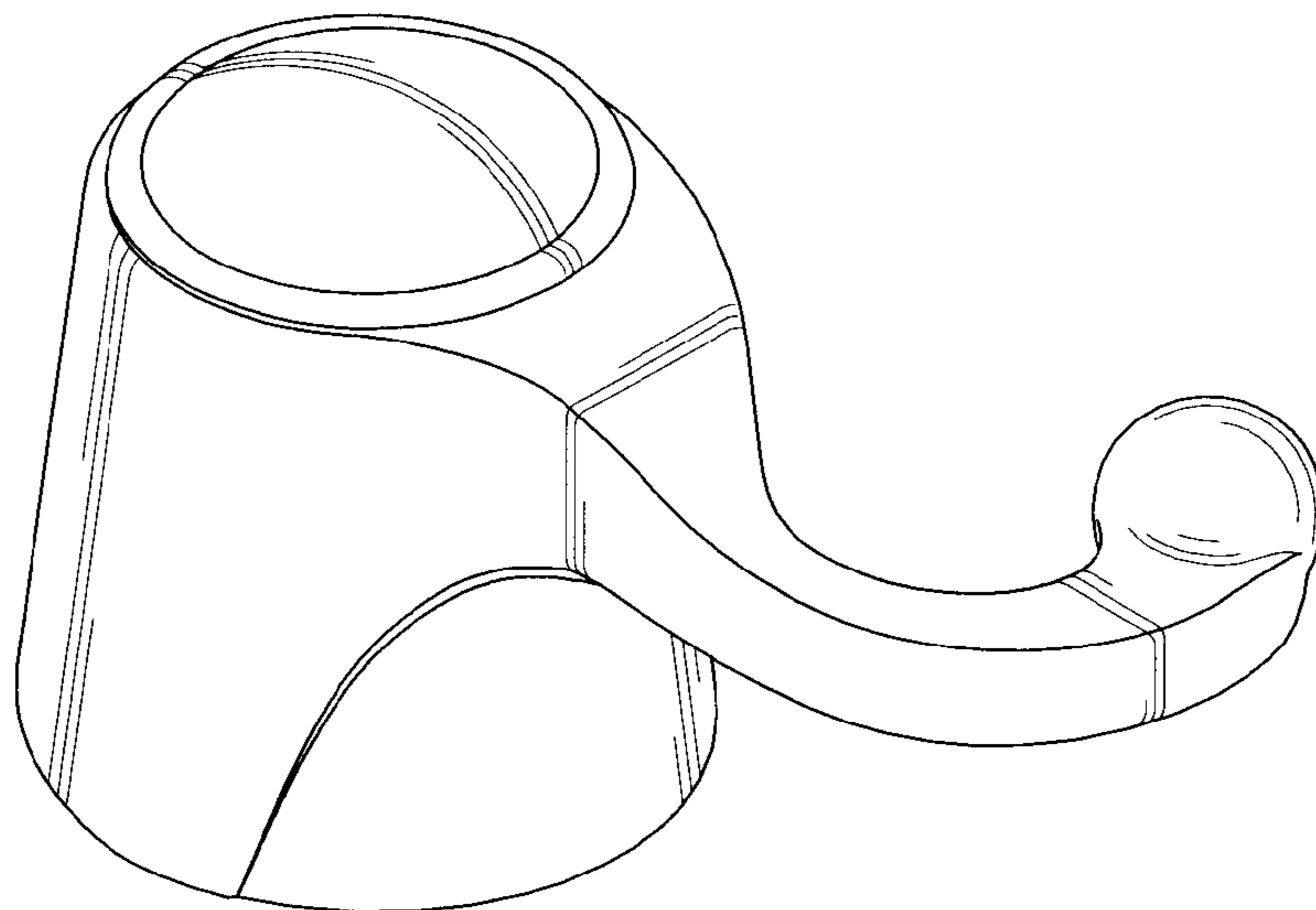
**DESCRIPTION**

FIG. 1 is a perspective view of a handle of the new design; FIG. 2 is a front elevational view of the handle of FIG. 1; FIG. 3 is a rear elevational view of the handle of FIG. 1; FIG. 4 is a left elevational view of the handle of FIG. 1; FIG. 5 is a right elevational view of the handle of FIG. 1; FIG. 6 is a top plan view of the handle of FIG. 1; and FIG. 7 is a bottom plan view of the handle of FIG. 1.

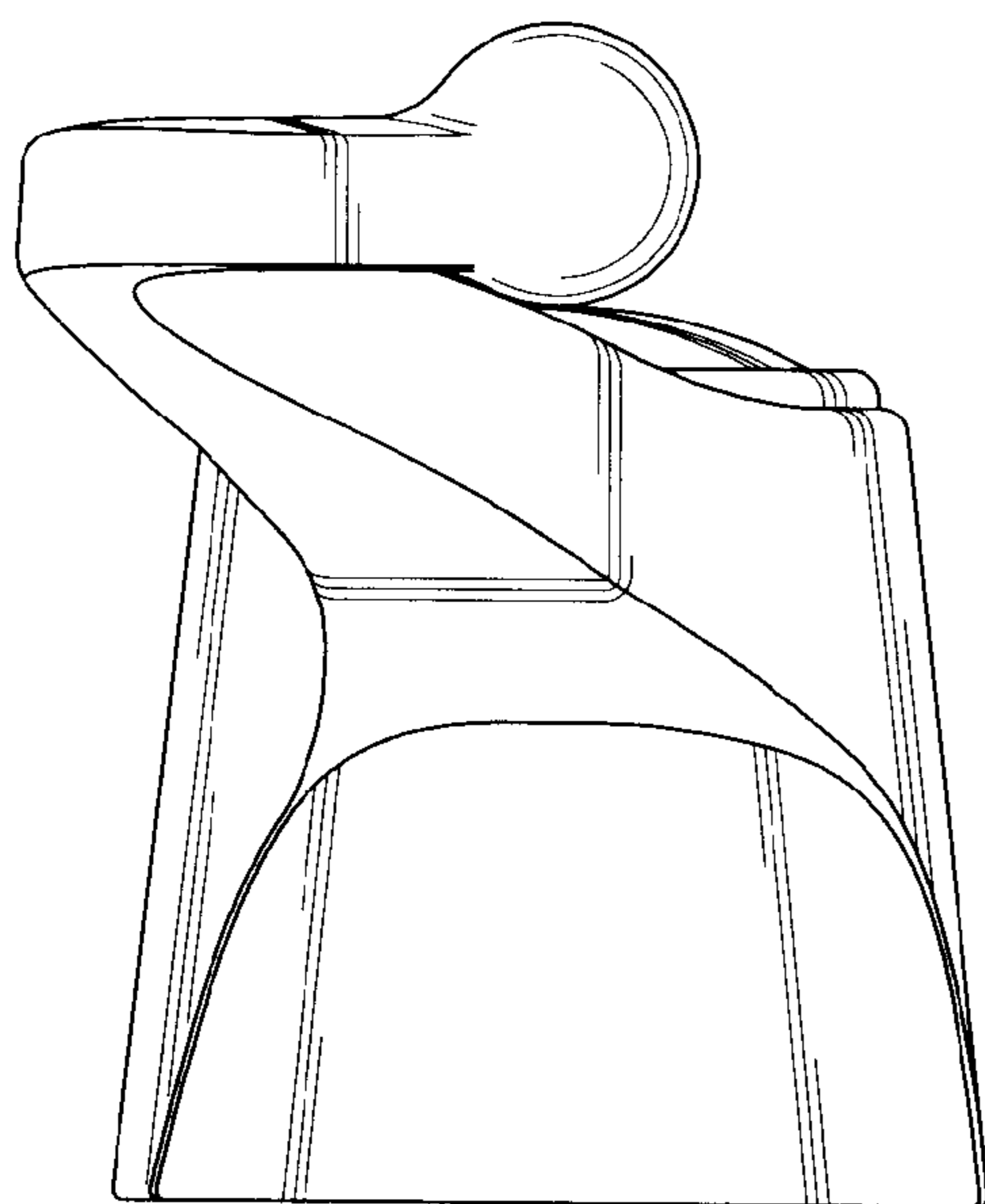
The portions of the Figures shown in broken lines are not part of the claimed design and are for illustration only.

**1 Claim, 3 Drawing Sheets**

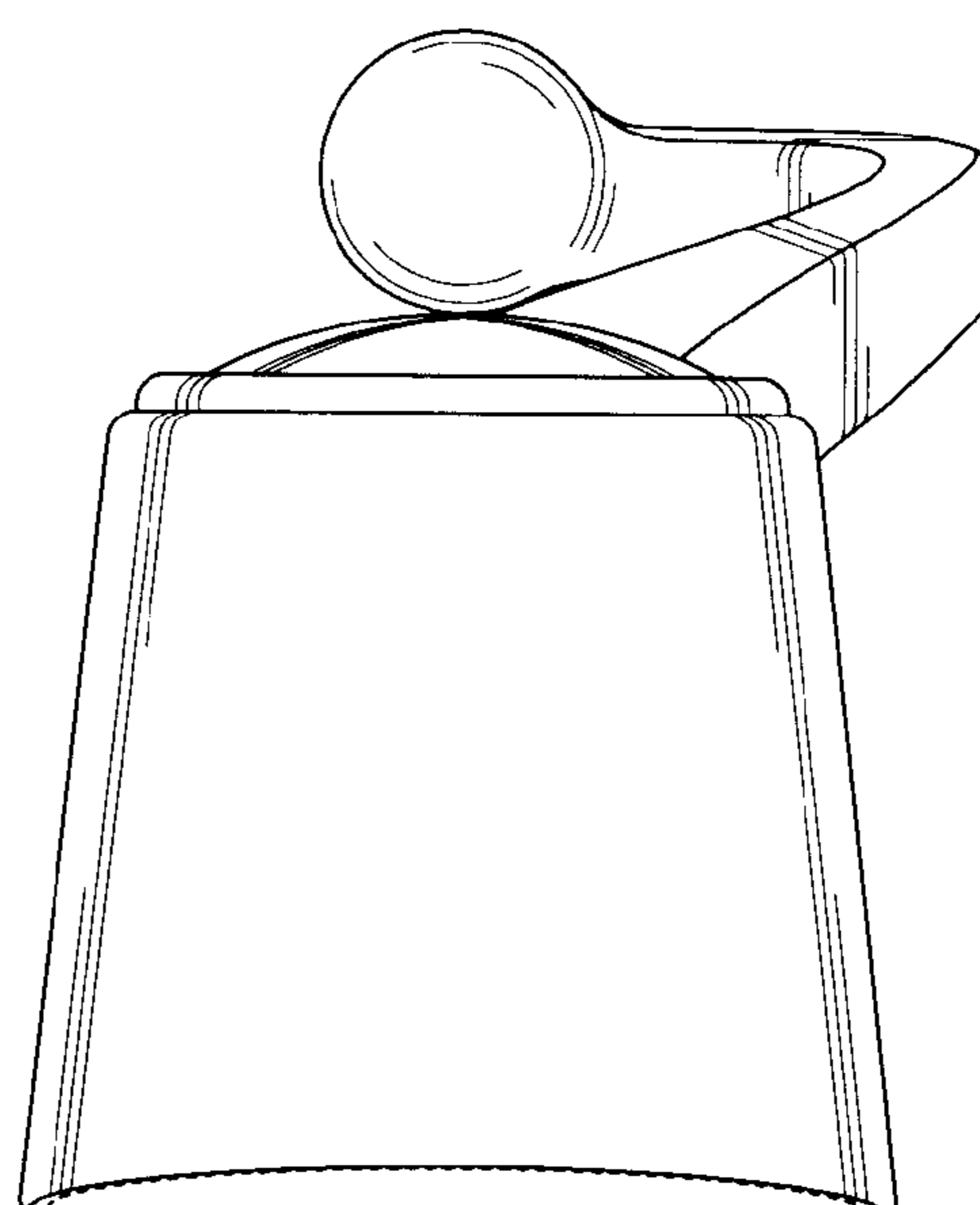




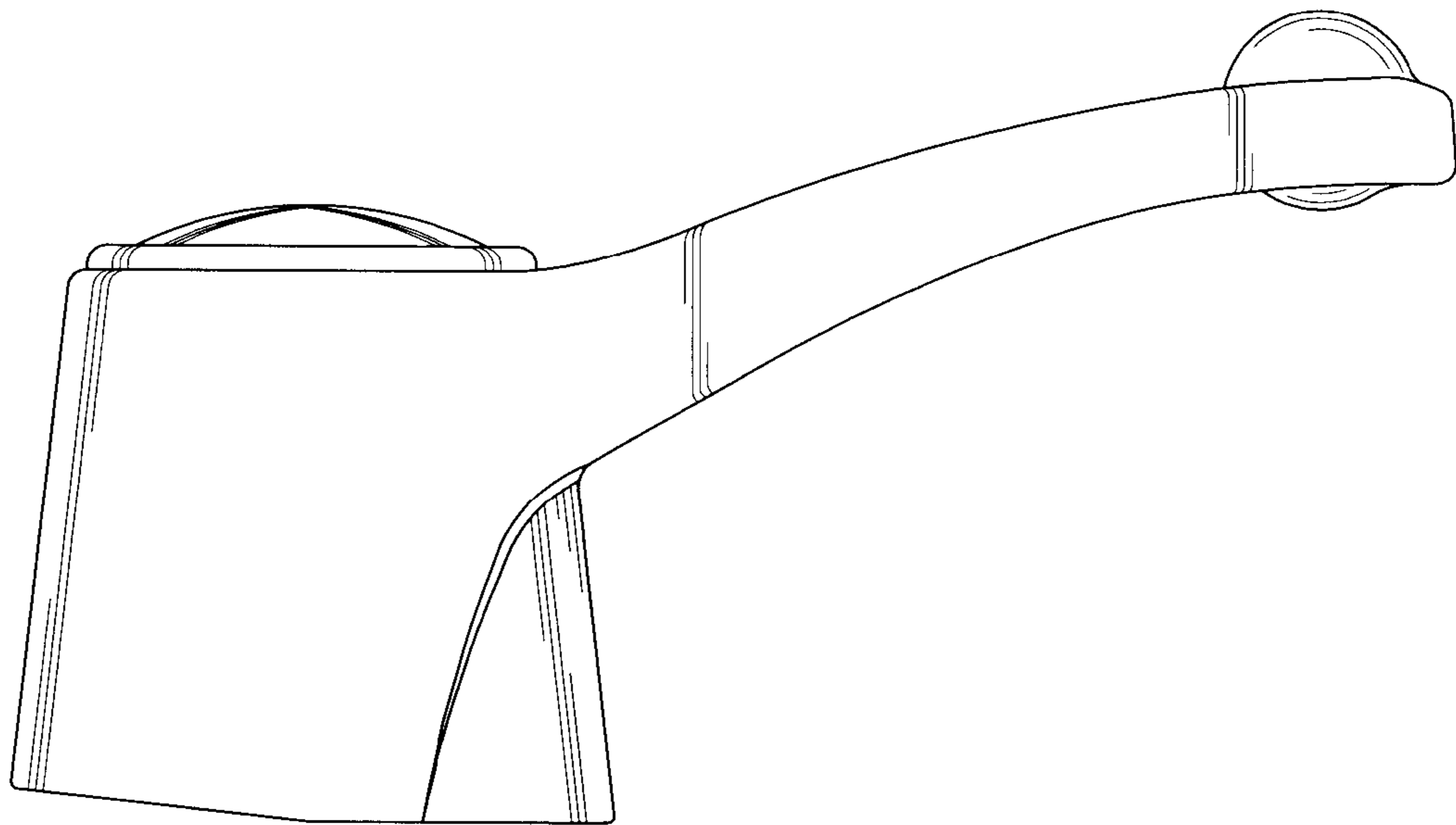
**FIG. 1**



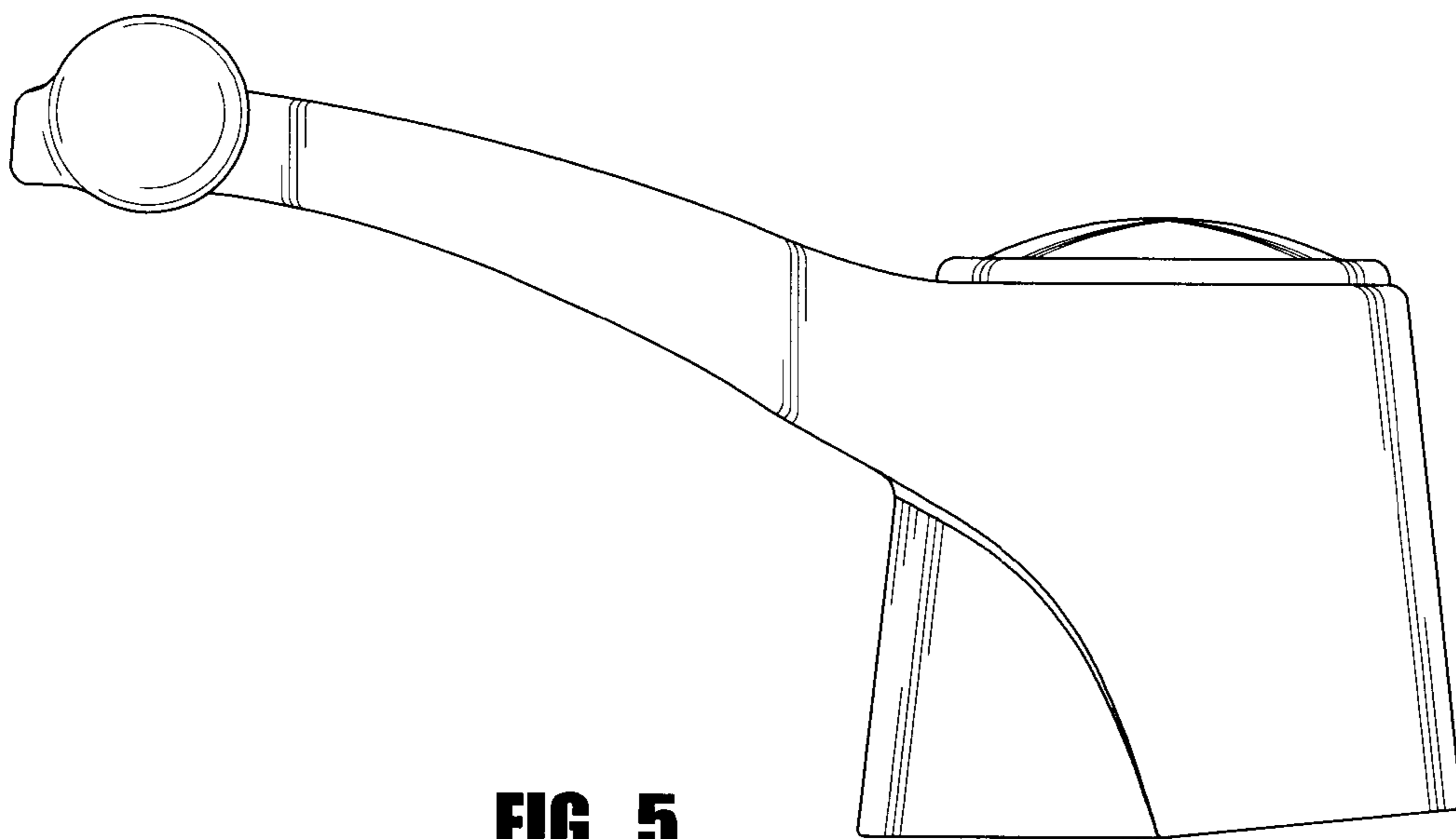
**FIG. 2**



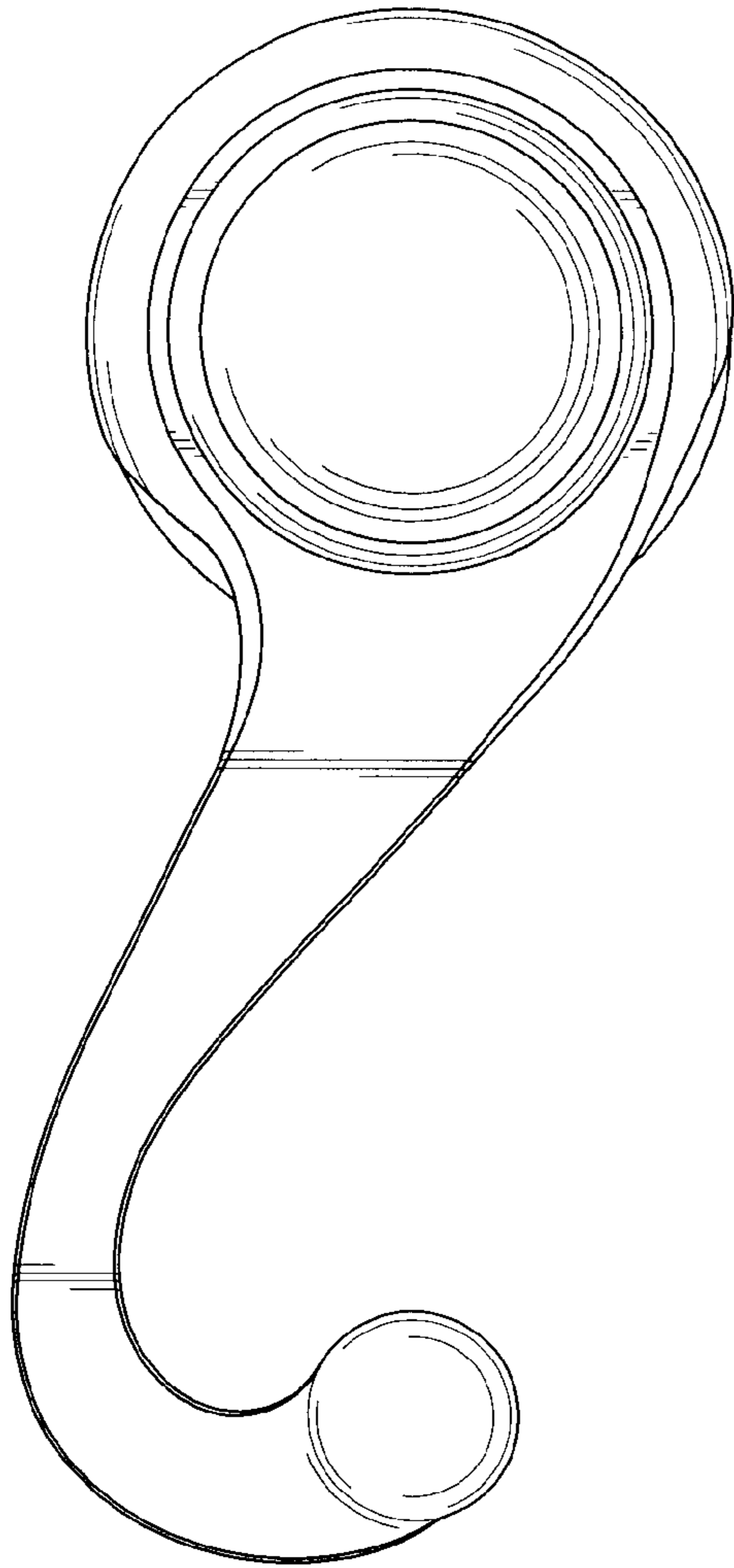
**FIG. 3**



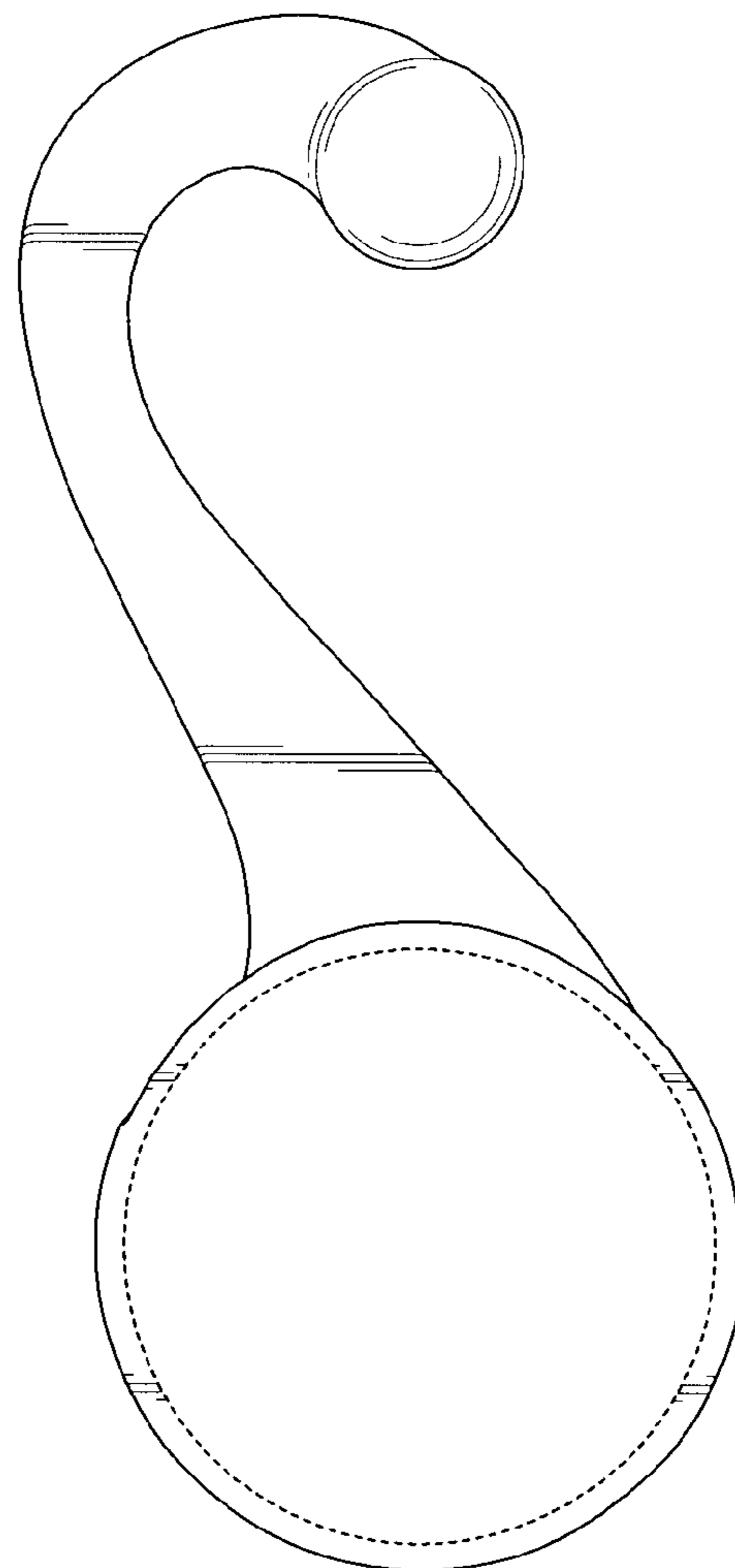
**FIG. 4**



**FIG. 5**



**FIG. 6**



**FIG. 7**