



US00D535161S

(12) **United States Design Patent**
So

(10) **Patent No.:** **US D535,161 S**

(45) **Date of Patent:** **** Jan. 16, 2007**

(54) **FOOD SLICER**

(76) **Inventor:** **Kwok Kuen So**, 2nd Floor, Chaun Yuan
Factory Building, 342-344 Kwun Tong
Road, Kowloon, Hong Kong SAR (HK)

(**) **Term:** **14 Years**

(21) **Appl. No.:** **29/234,954**

(22) **Filed:** **Jul. 25, 2005**

(30) **Foreign Application Priority Data**

Feb. 7, 2005 (EM) 000291711

(51) **LOC (8) Cl.** **07-04**

(52) **U.S. Cl.** **D7/673; D7/678**

(58) **Field of Classification Search** D7/672,
D7/673, 677, 678, 381, 693, 695; 241/93,
241/95, 168, 169, 101.1, 101.2, 273.1-273.4;
83/437.5, 437.7, 932, 856, 699.51, 699.61
See application file for complete search history.

(56) **References Cited**

U.S. PATENT DOCUMENTS

2,737,721 A * 3/1956 Hart 83/437.5

3,858,815 A * 1/1975 Black 241/168
D336,214 S * 6/1993 Boerner D7/673
D347,149 S * 5/1994 Feer et al. D7/678
D494,026 S * 8/2004 Brousseau et al. D7/678

* cited by examiner

Primary Examiner—Terry A. Wallace

(74) *Attorney, Agent, or Firm*—Alix, Yale & Ristas, LLP

(57) **CLAIM**

The ornamental design for a food slicer, as shown and described.

DESCRIPTION

FIG. 1 is a rear end, left side and top perspective view of a food slicer showing my new design;

FIG. 2 is a front end, left side and top perspective view thereof;

FIG. 3 is a left side elevational view thereof; the right side elevational view being a mirror image;

FIG. 4 is a front end elevational view thereof;

FIG. 5 is a rear end elevational view thereof;

FIG. 6 is a top plan view thereof; and,

FIG. 7 is a bottom plan view thereof.

1 Claim, 3 Drawing Sheets

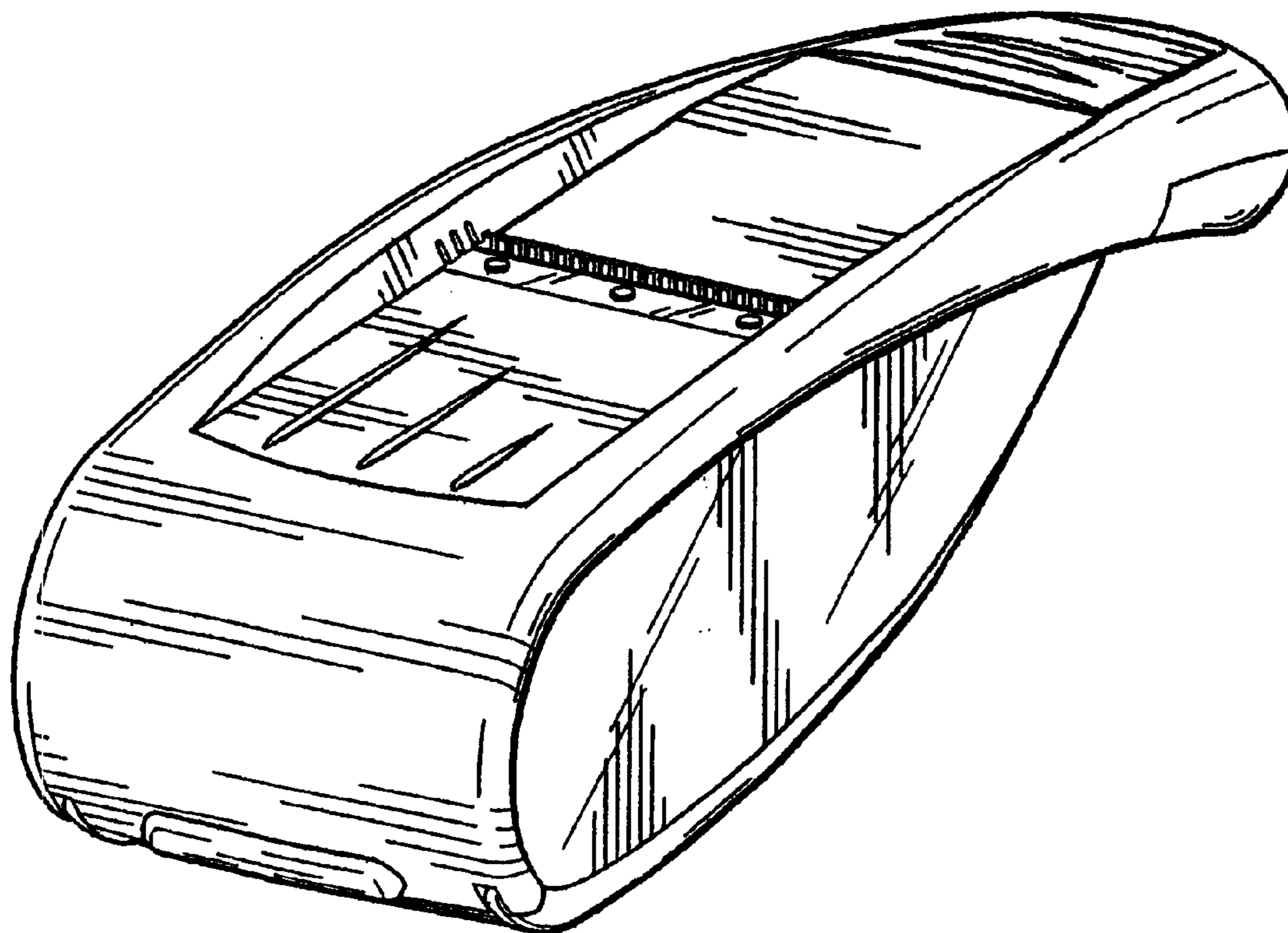

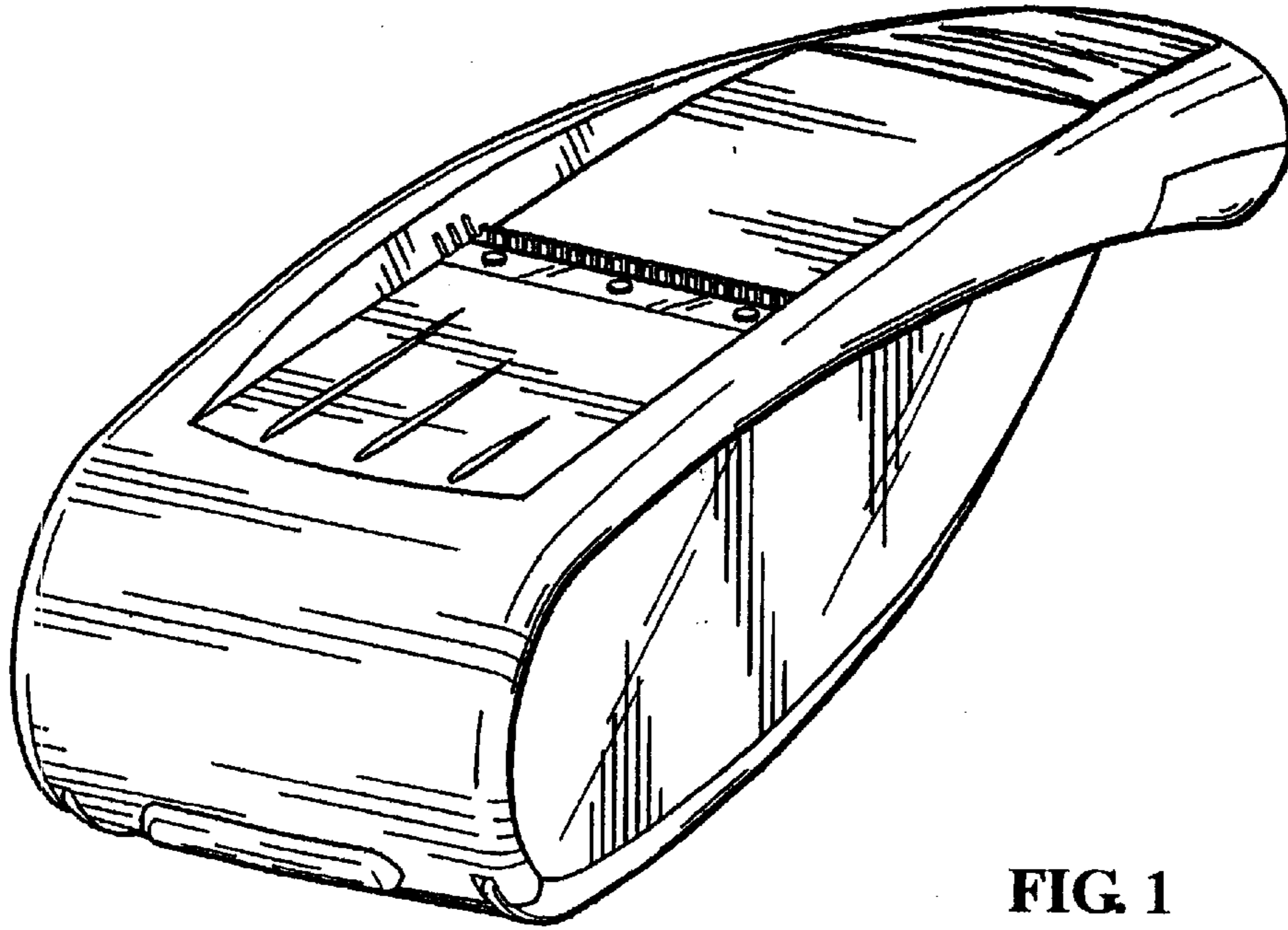

FIG. 1

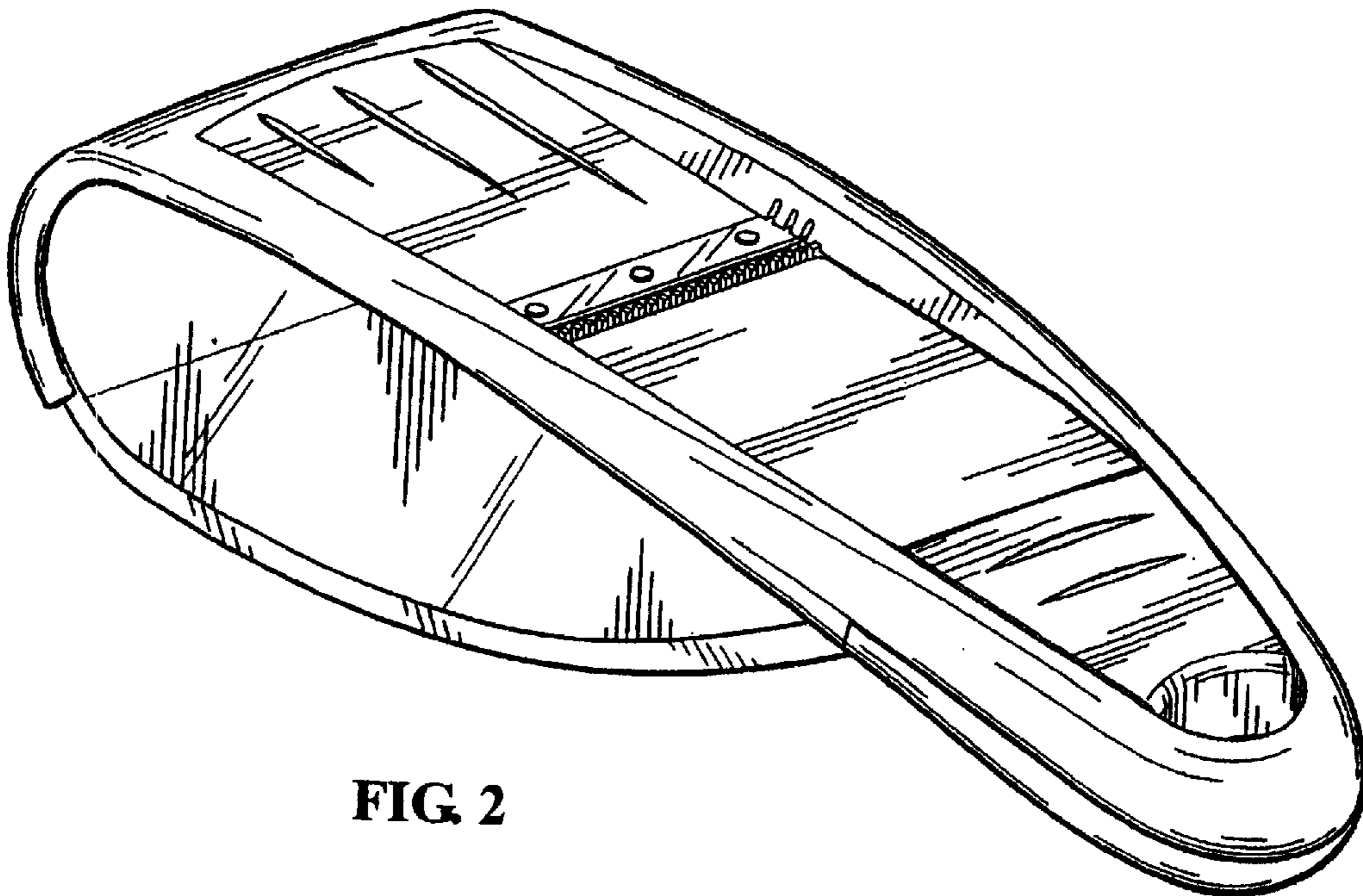

FIG. 2

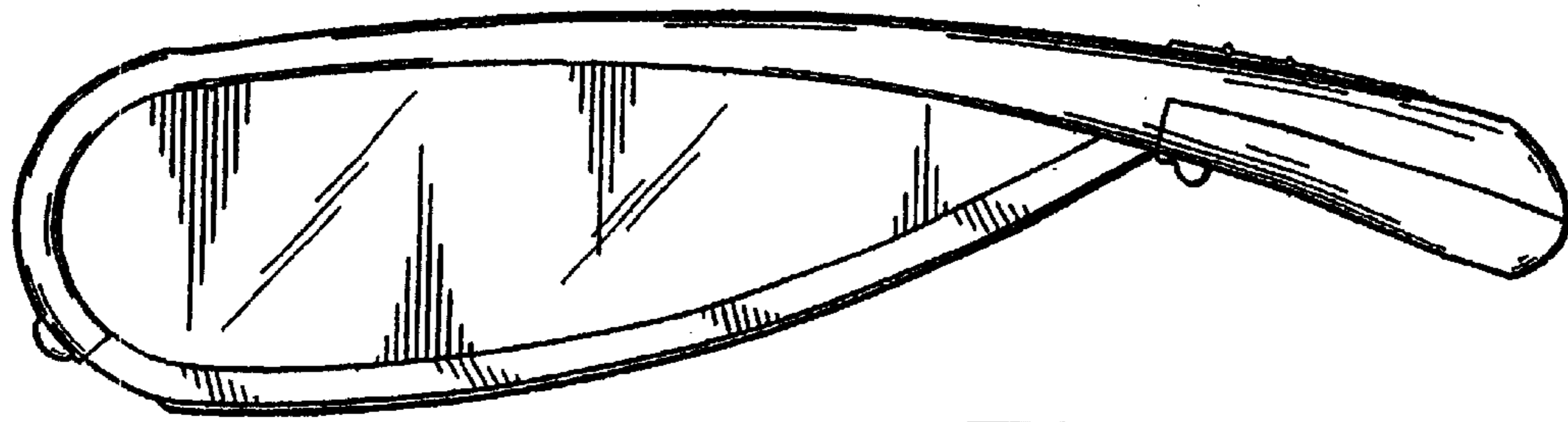

FIG. 3

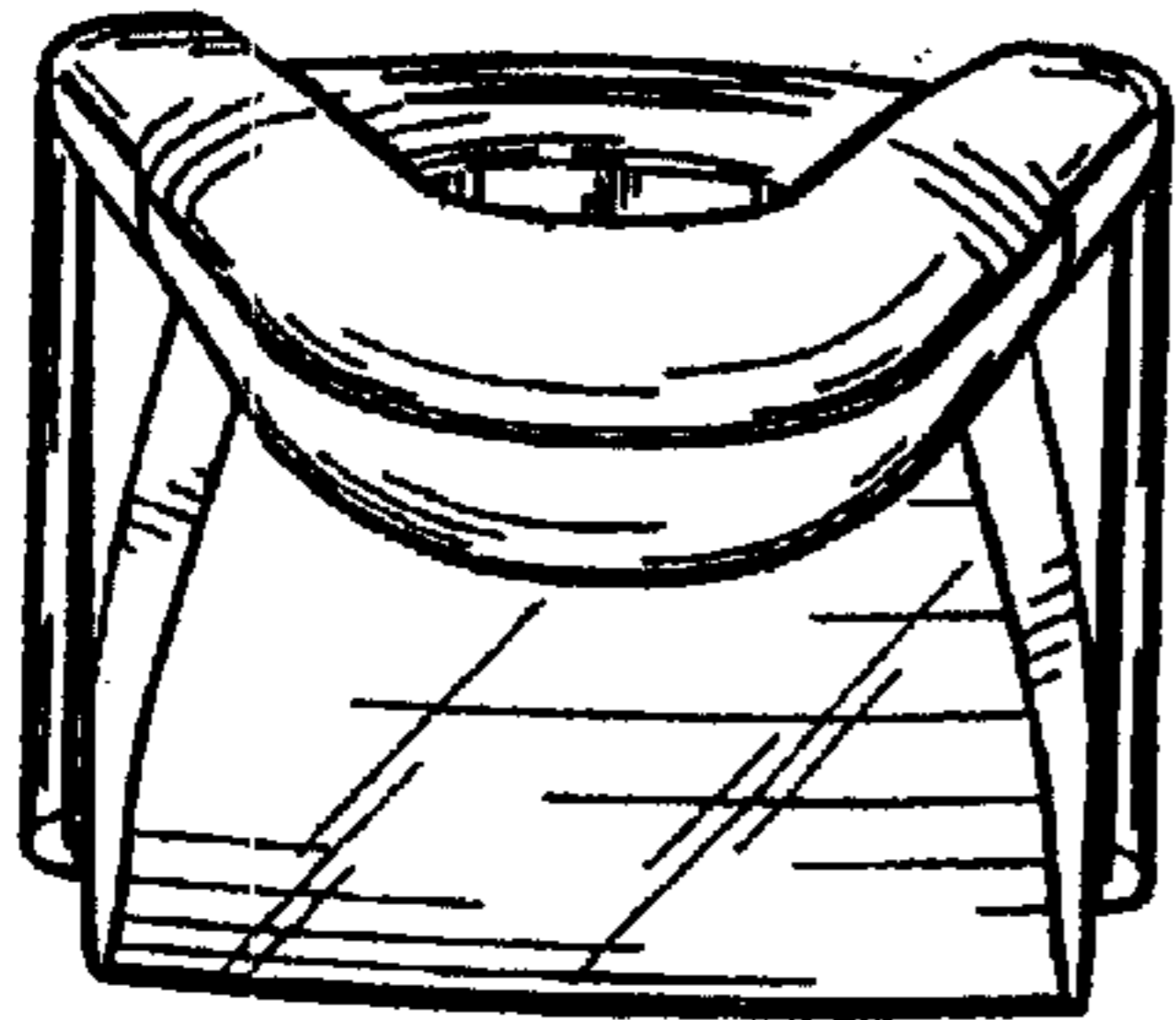

FIG. 4

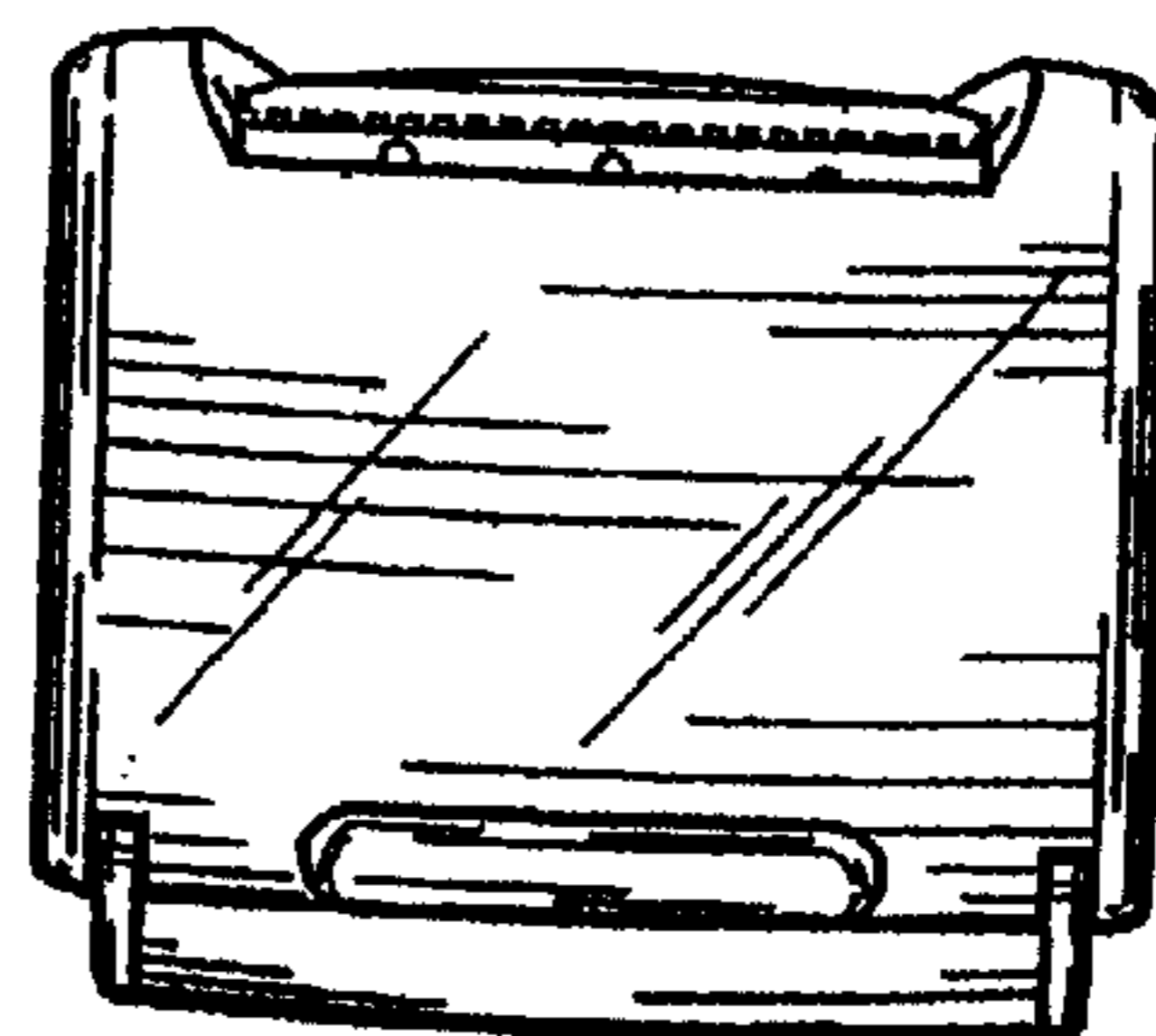

FIG. 5

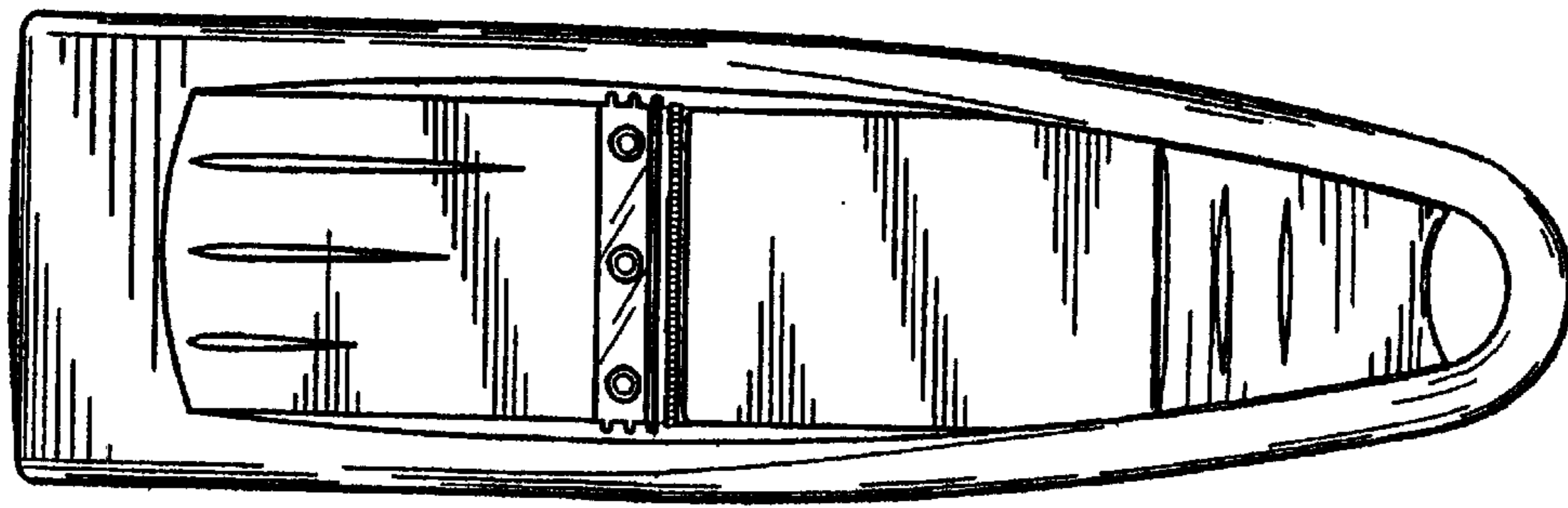

FIG. 6

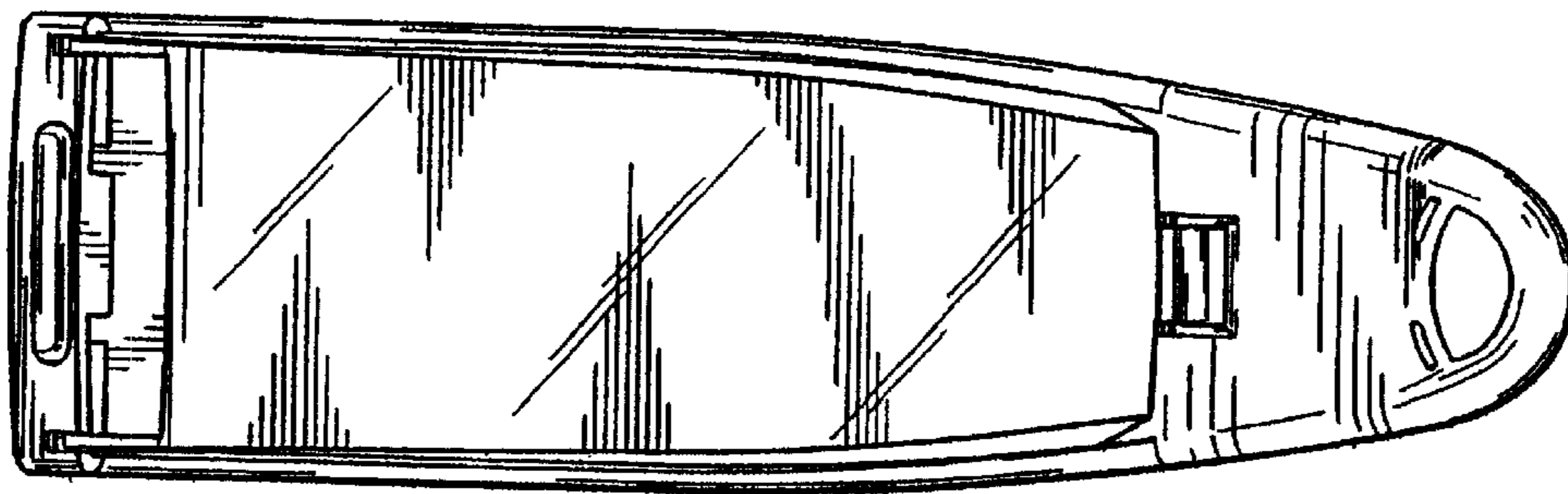

FIG. 7