



US00D535126S

(12) **United States Design Patent**
Loew et al.

(10) **Patent No.:** **US D535,126 S**
(45) **Date of Patent:** **** *Jan. 16, 2007**

(54) **SEAT AND BACK**

(75) Inventors: **Glen Oliver Loew**, Hamburg (DE);
Kurt R. Heidmann, Grand Rapids, MI
(US); **Bruce M. Smith**, Grand Rapids,
MI (US)

(73) Assignee: **Steelcase Development Corporation**,
Caledonia, MI (US)

(*) Notice: This patent is subject to a terminal dis-
claimer.

(**) Term: **14 Years**

(21) Appl. No.: **29/254,841**

(22) Filed: **Feb. 28, 2006**

Related U.S. Application Data

(62) Division of application No. 29/200,702, filed on Mar. 3,
2004.

(51) **LOC (8) Cl.** **06-06**

(52) **U.S. Cl.** **D6/500; D6/366**

(58) **Field of Classification Search** D6/334-336,
D6/364, 365, 366, 367, 369, 370, 500-502;
297/411.2, 411.27, 411.36, 452.29, 300.1,
297/452.63

See application file for complete search history.

(56) **References Cited**

U.S. PATENT DOCUMENTS

D444,309 S * 7/2001 Nagamitsu D6/366
D476,493 S * 7/2003 Nagamitsu D6/366

D477,469 S * 7/2003 Brooks D6/366
D499,895 S * 12/2004 Olson et al. D6/366
D509,671 S * 9/2005 Olson et al. D6/366
D509,969 S * 9/2005 Loew et al. D6/366
2004/0051358 A1 * 3/2004 Bodnar et al. 297/300.1
2004/0245827 A1 * 12/2004 Bedford et al. 297/300.1
2004/0245839 A1 * 12/2004 Bodnar et al. 297/452.63
2005/0029848 A1 * 2/2005 Heidmann et al. 297/300.1

* cited by examiner

Primary Examiner—Mimosa De

(74) *Attorney, Agent, or Firm*—Price, Heneveld, Cooper,
DeWitt & Litton LLP

(57) **CLAIM**

We claim the ornamental design for a seat and back, as
shown and described.

DESCRIPTION

FIGS. 1-2 are front and rear perspective views of a first
embodiment of a seat and back embodying the present
invention; and

FIGS. 3-8 are right, front, left, rear, top, and bottom views,
respectively, of the seat and back shown in FIGS. 1-2.

FIGS. 9-10 are front and rear perspective views of a second
embodiment of a seat and back embodying the present
invention; and,

FIGS. 11-16 are right, front, left, rear, top, and bottom
views, respectively, of the seat and back shown in FIGS.
9-10.

The dashed lines in FIGS. 1-16 show the environment of the
present articles, but do not form a part of the claimed
invention.

1 Claim, 8 Drawing Sheets

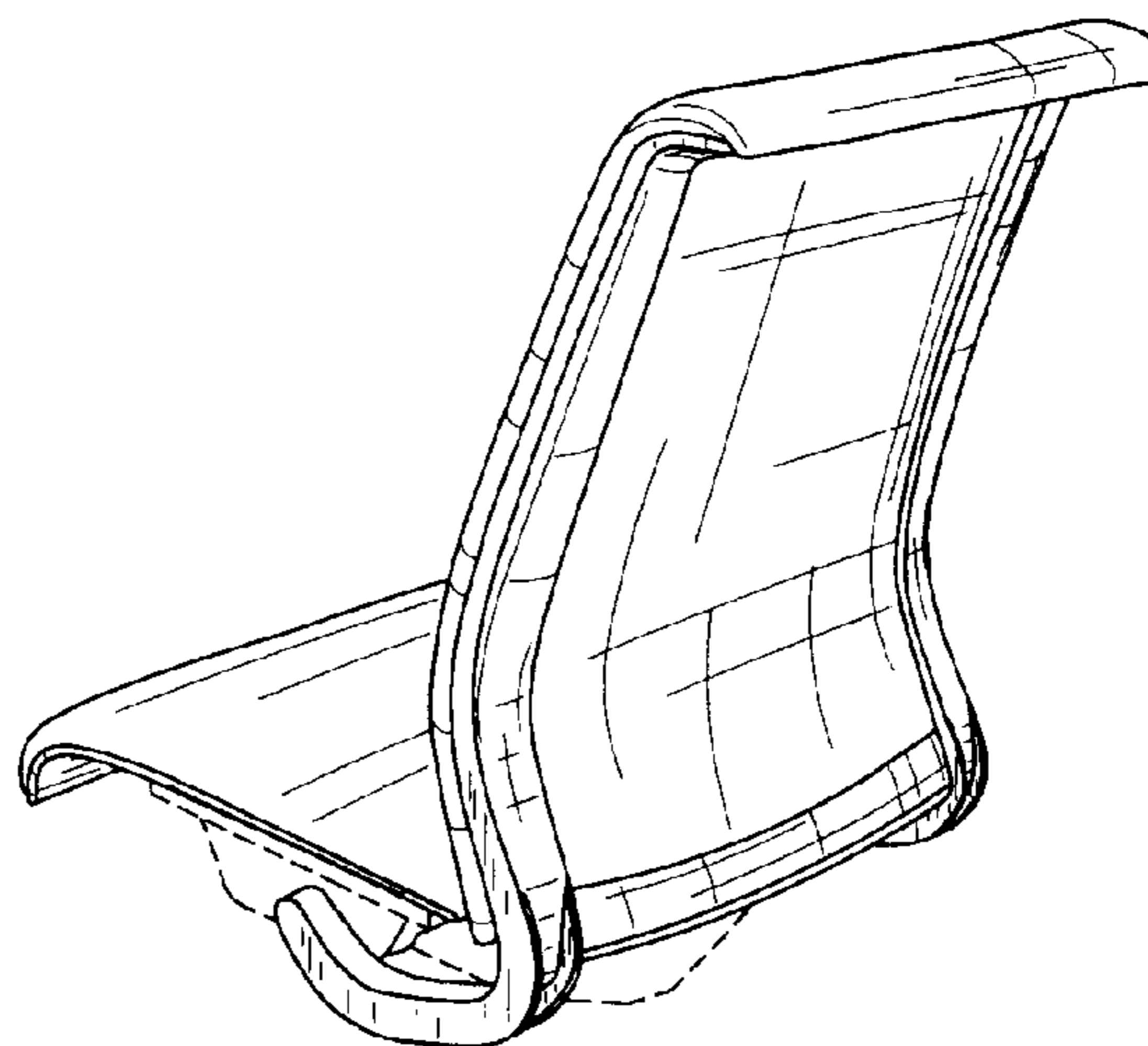
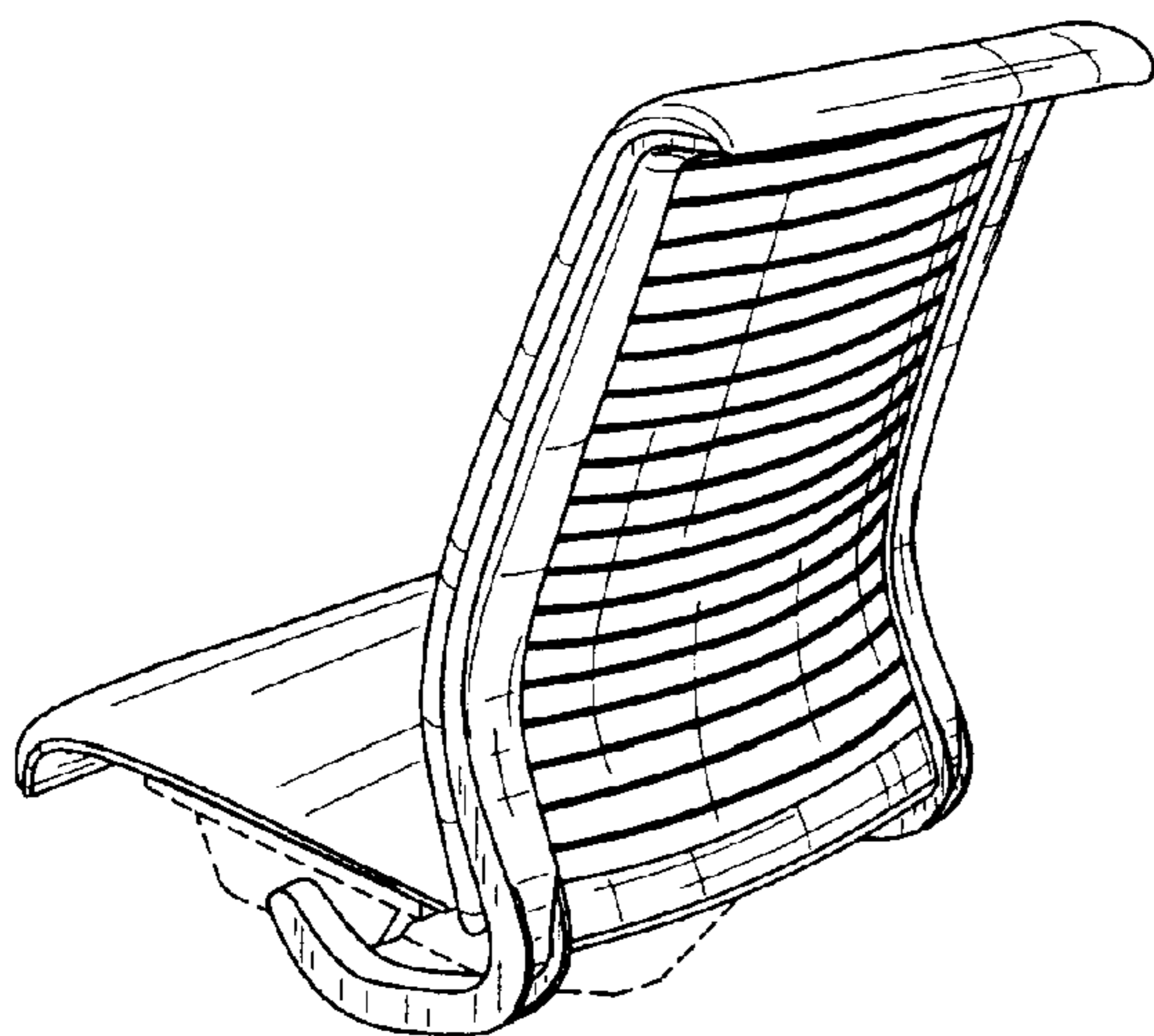

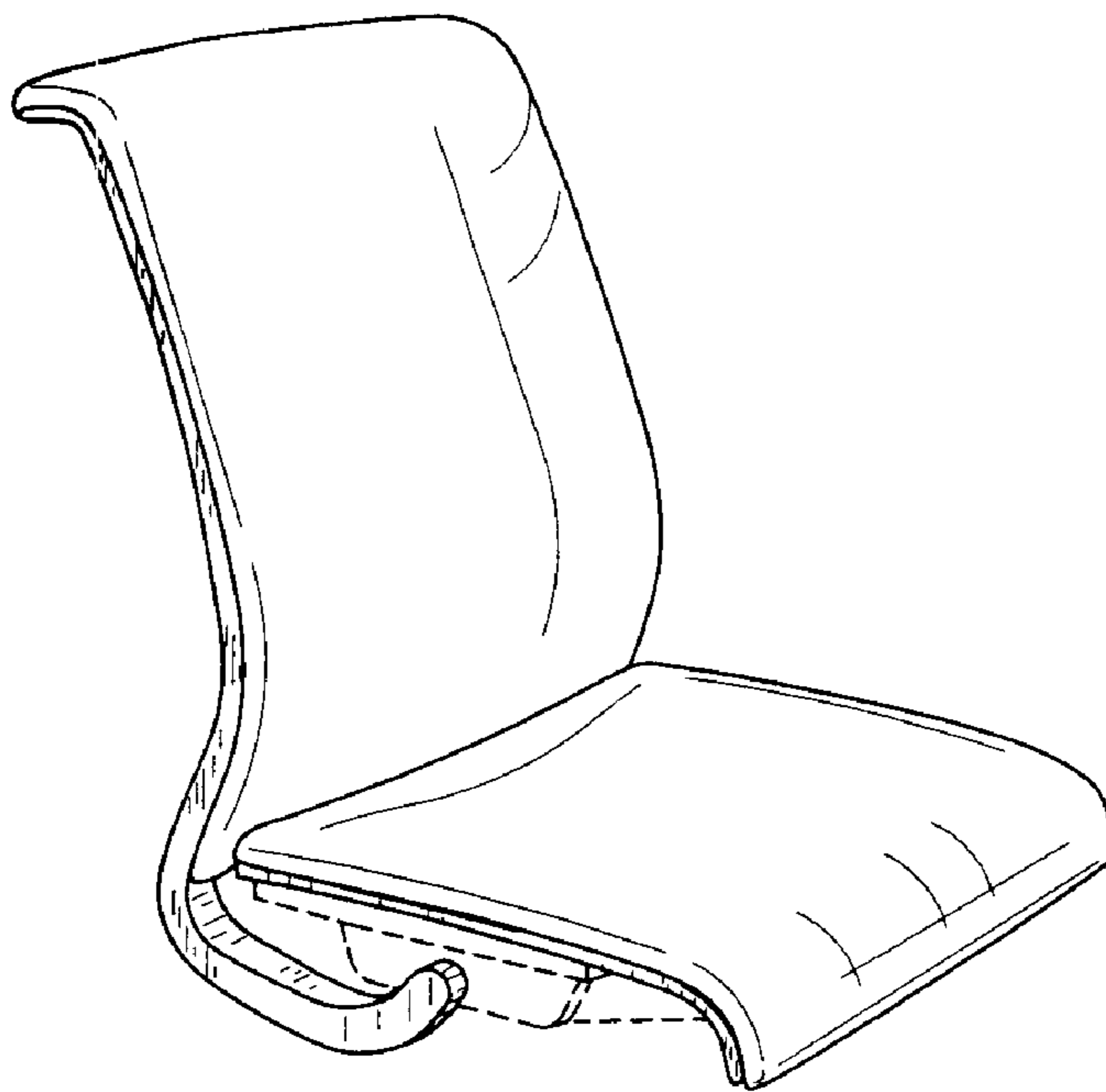

FIG. 1

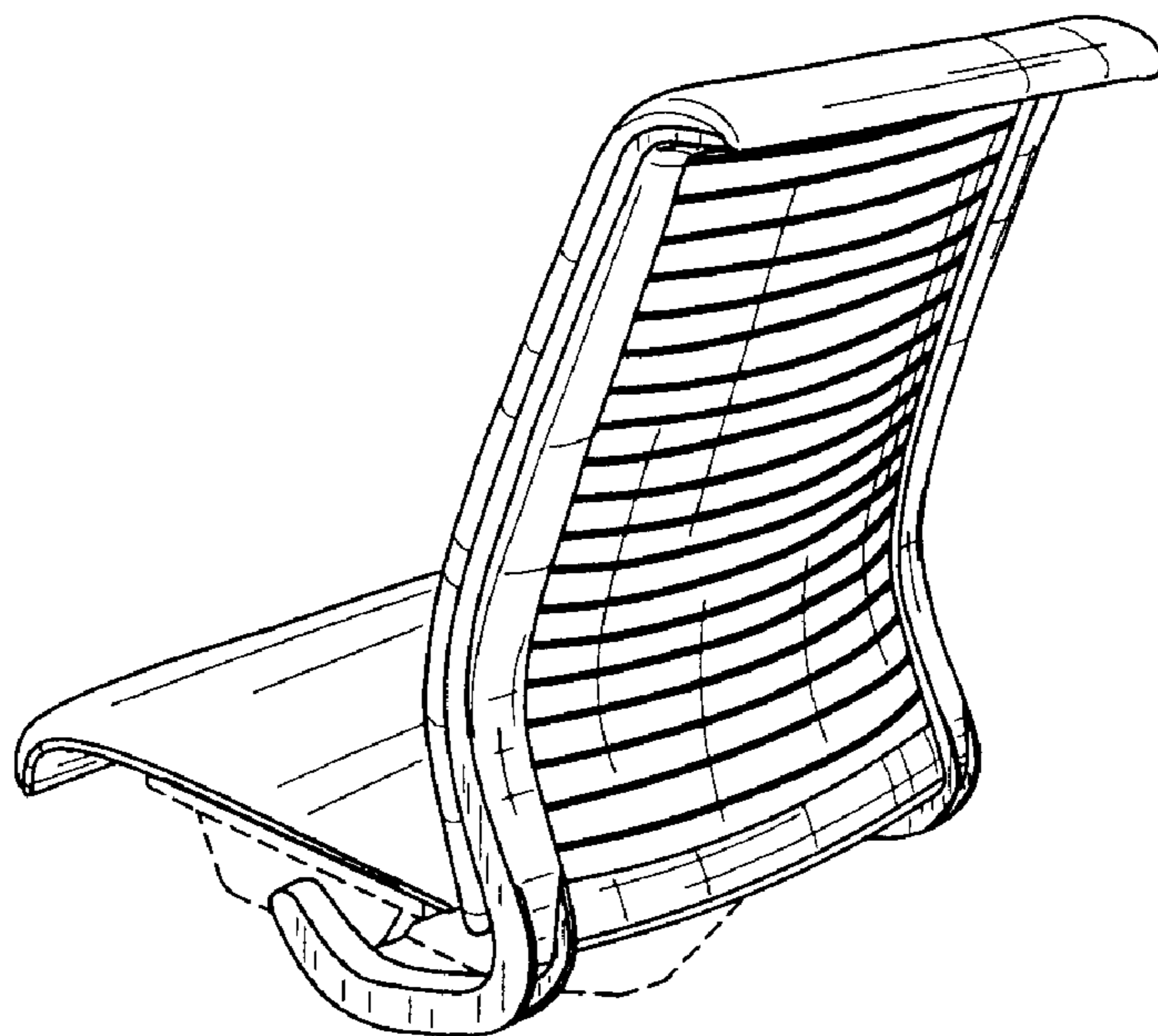

FIG. 2

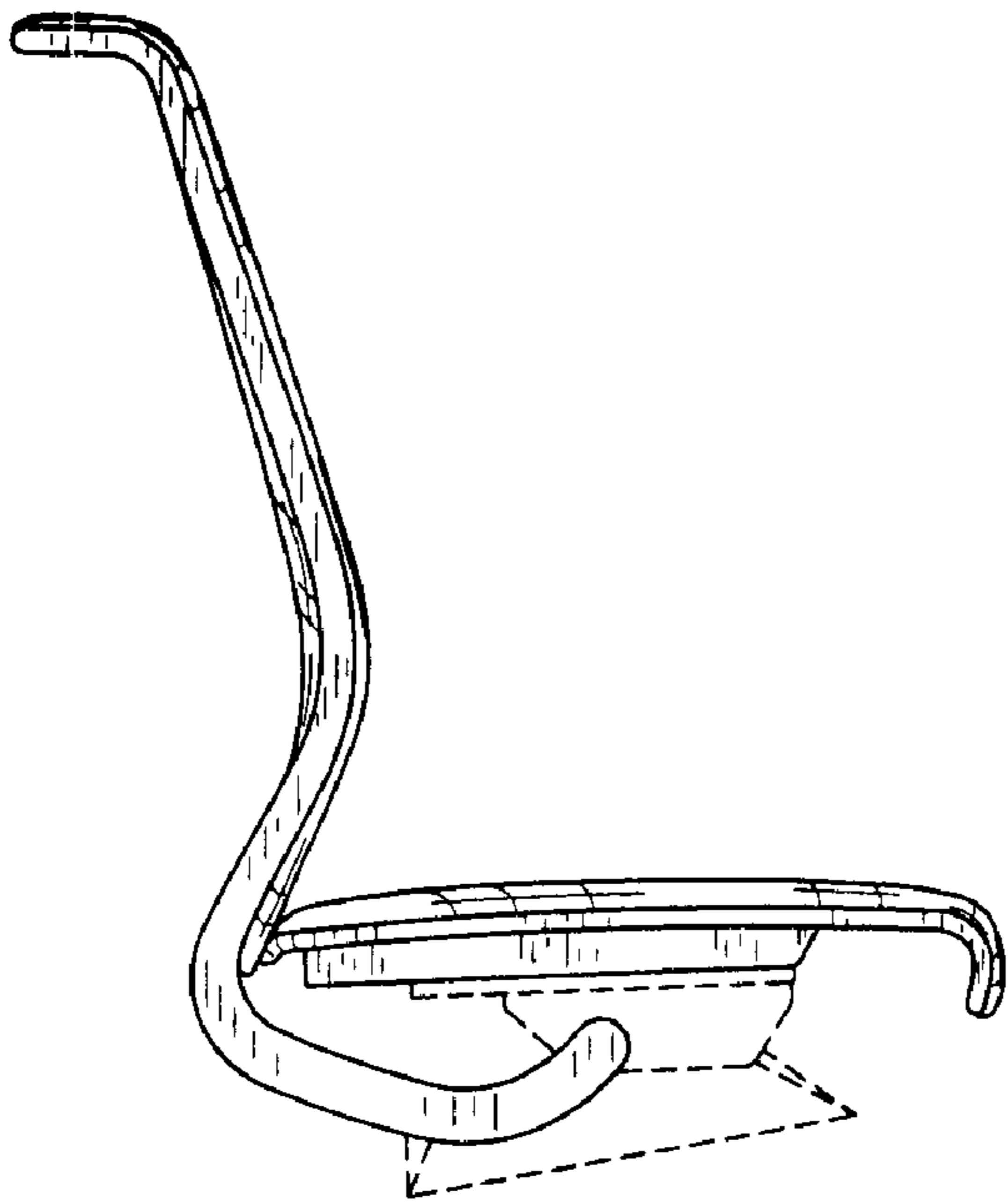

FIG. 3

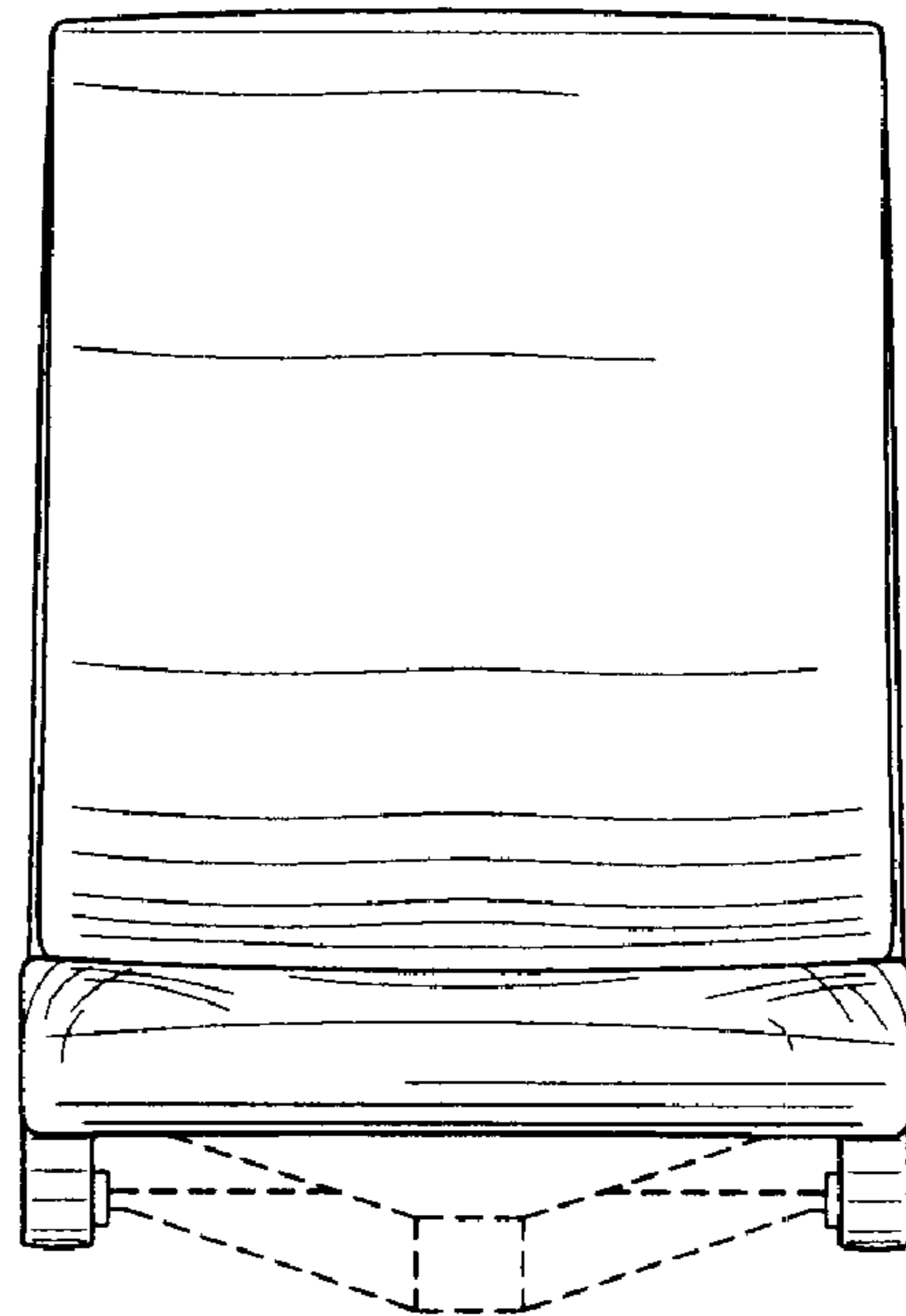

FIG. 4

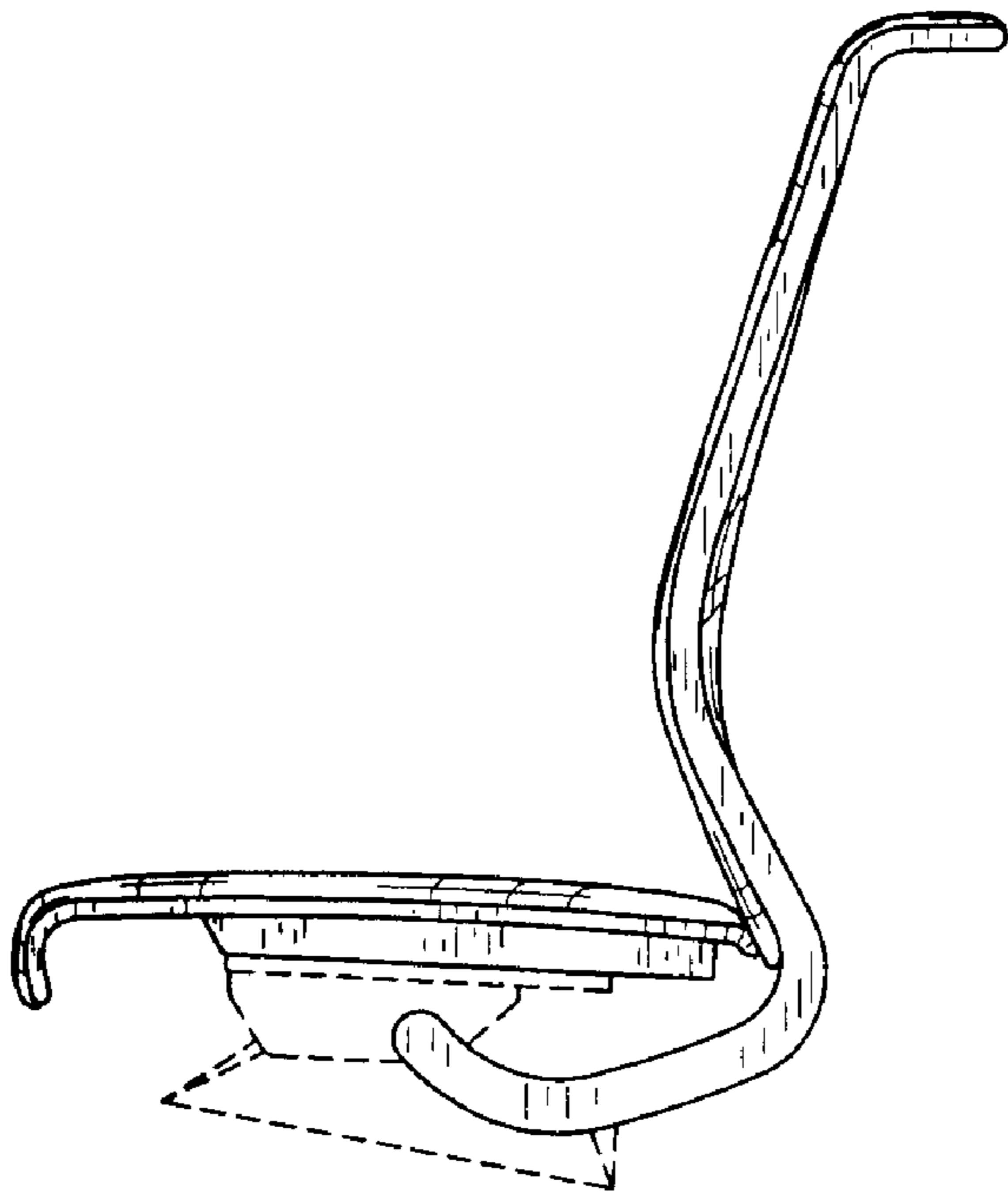

FIG. 5

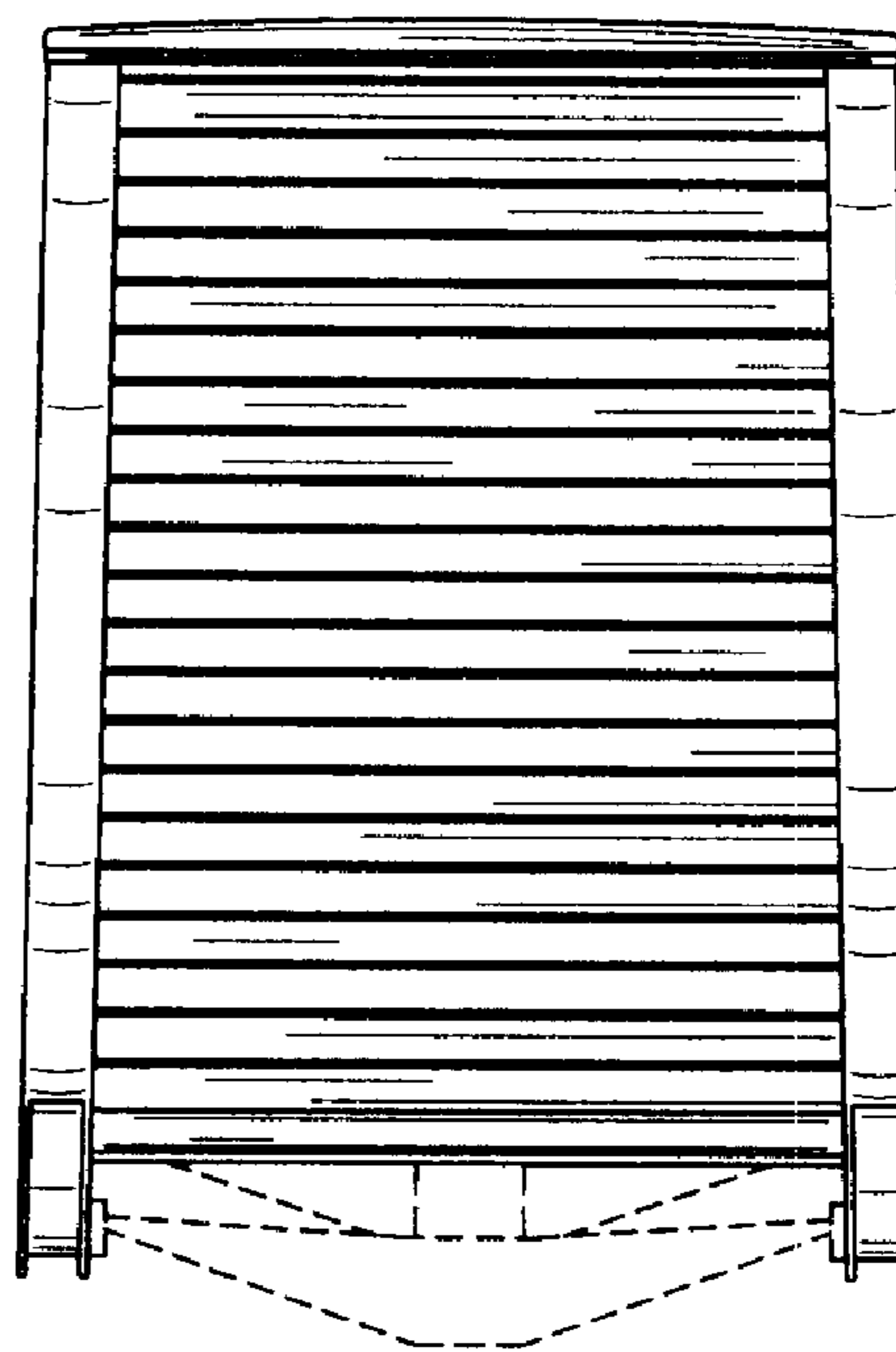

FIG. 6

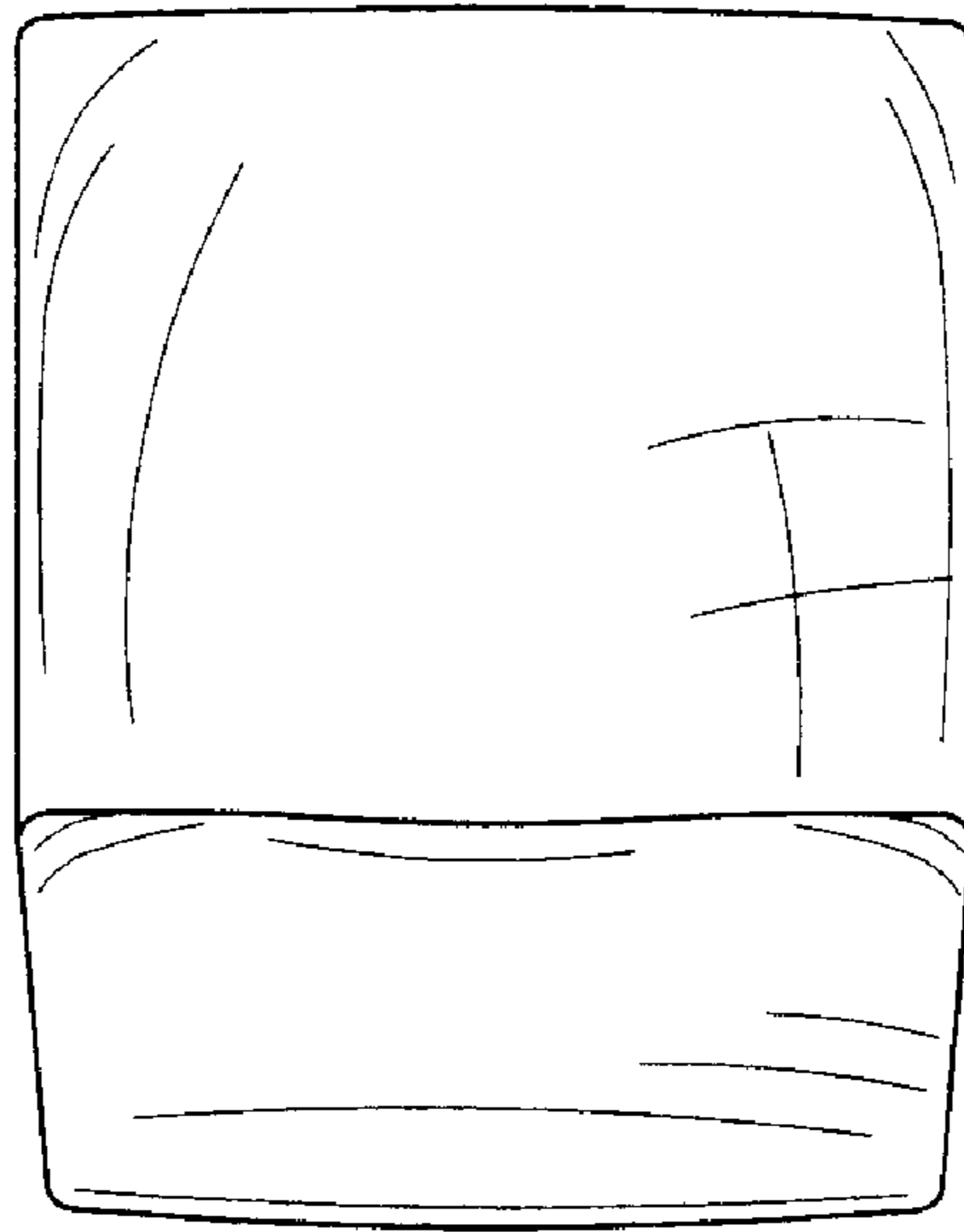

FIG. 7

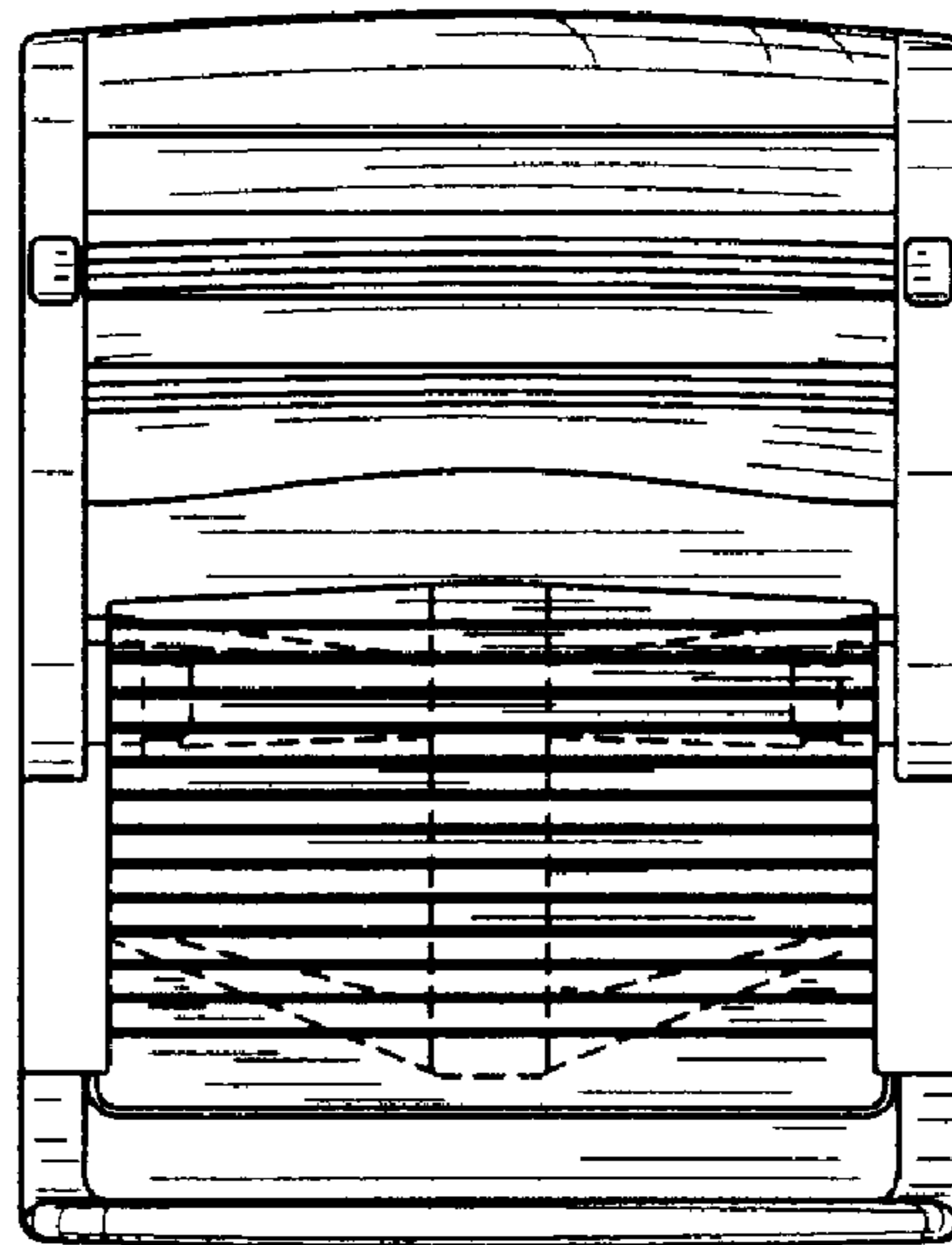

FIG. 8

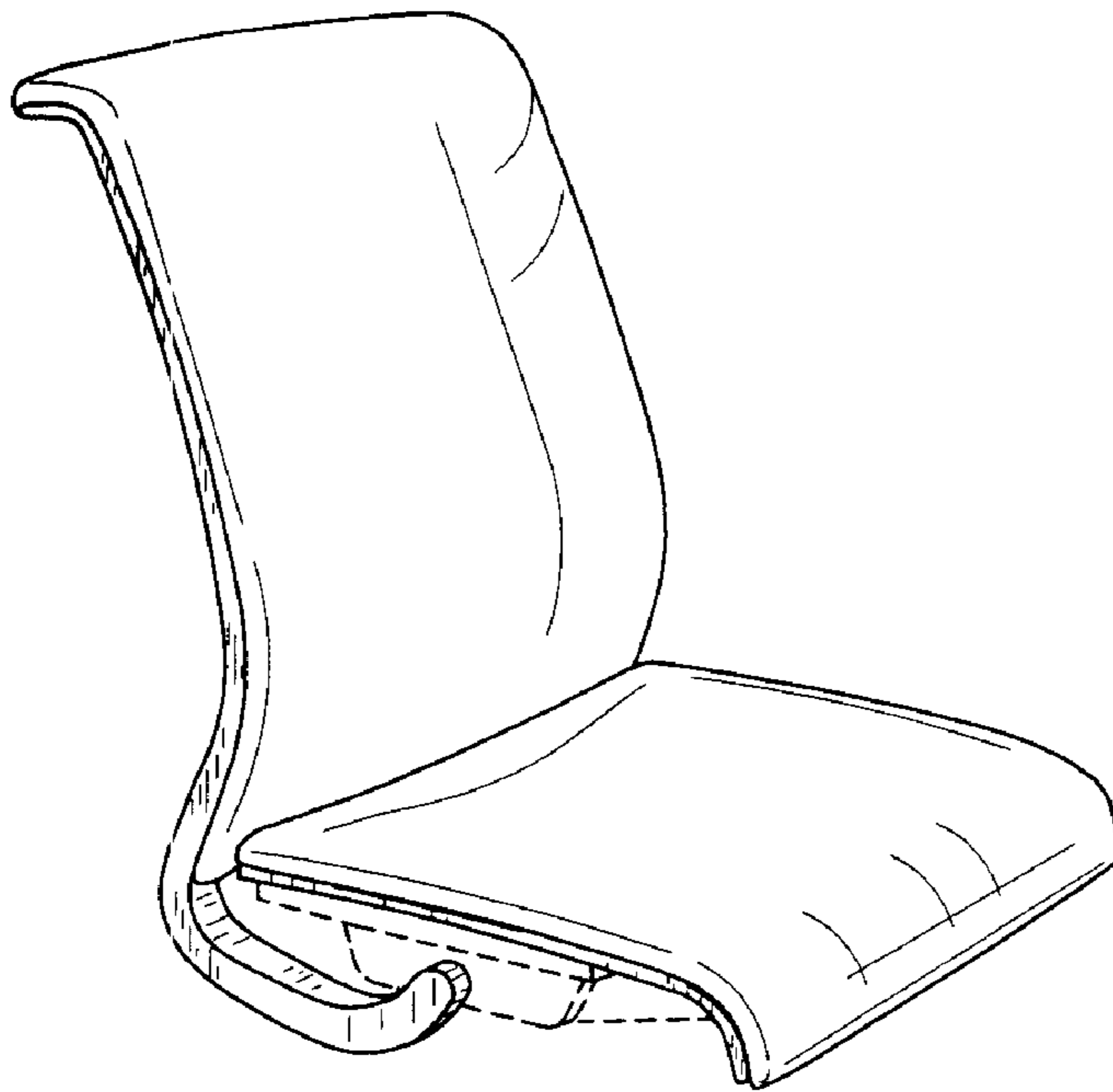

FIG. 9

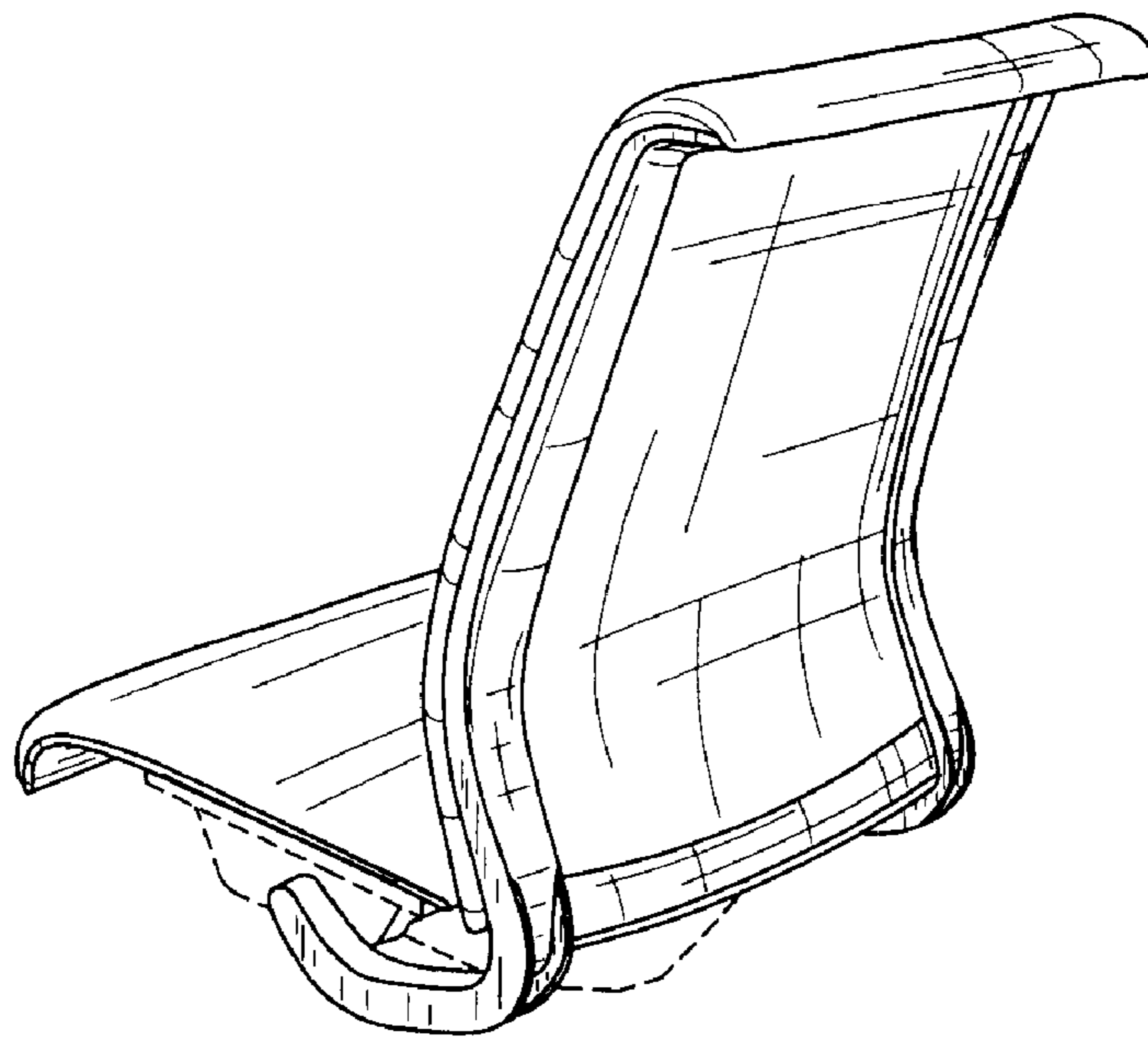

FIG. 10

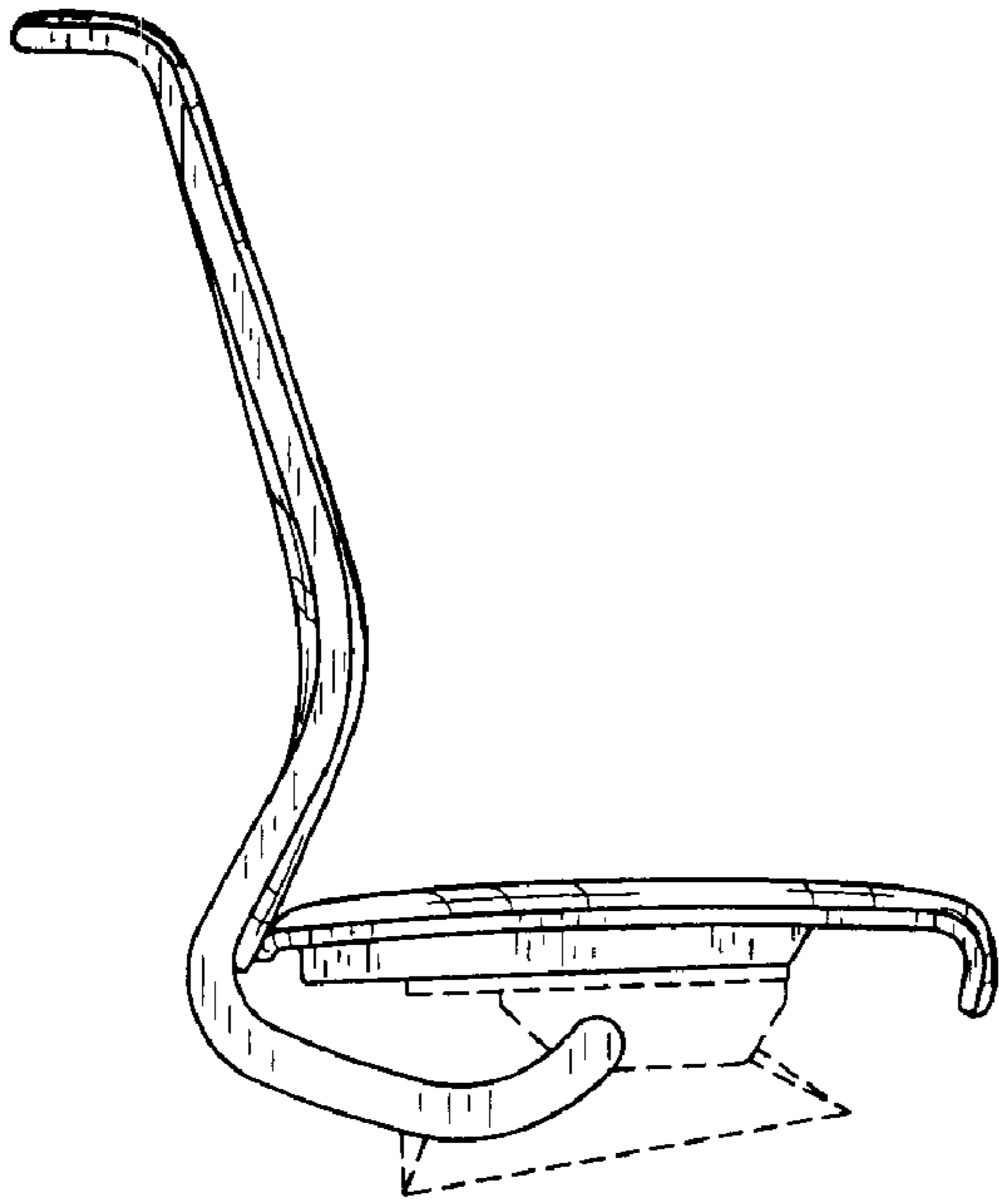

FIG. 11

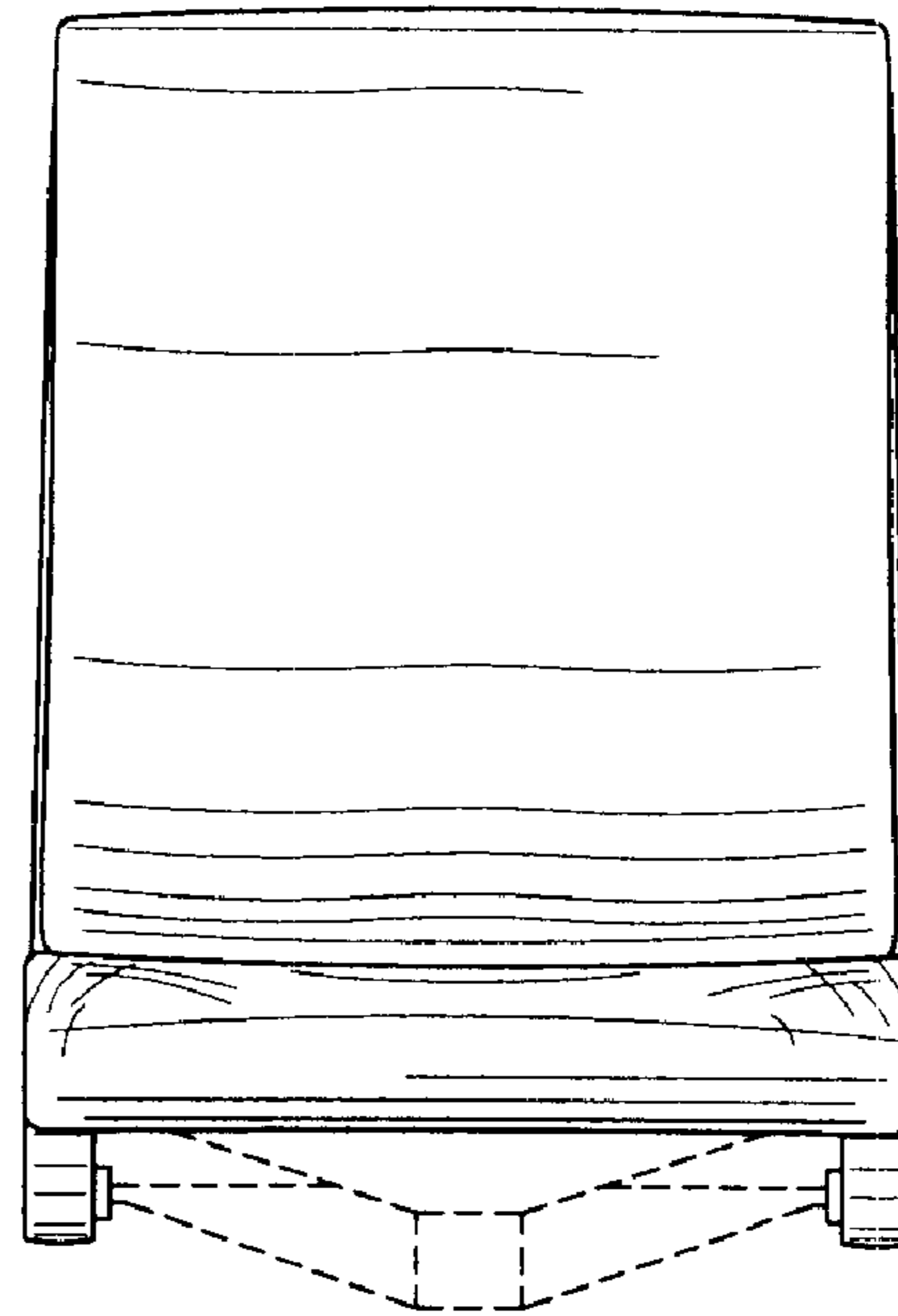

FIG. 12

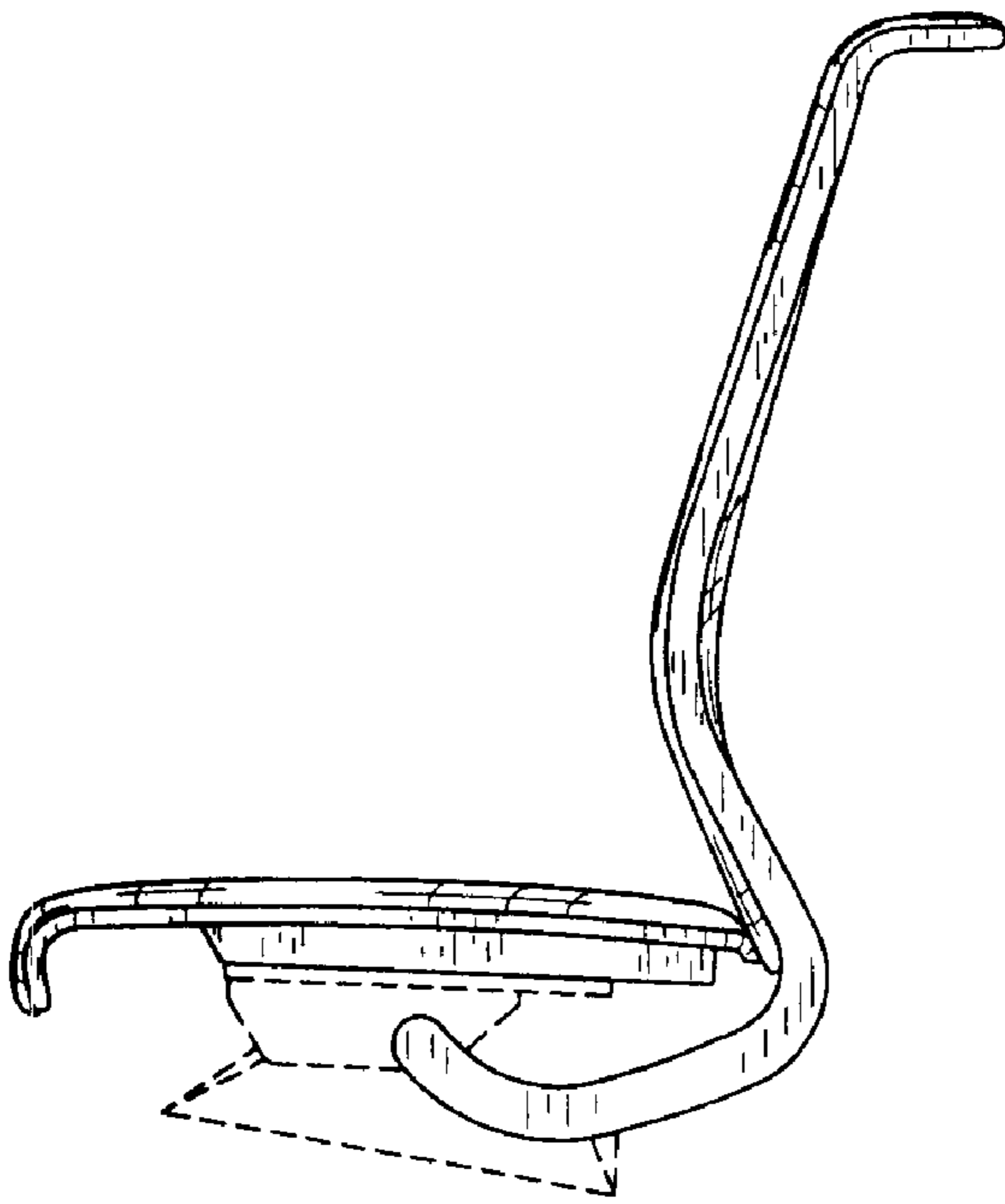

FIG. 13

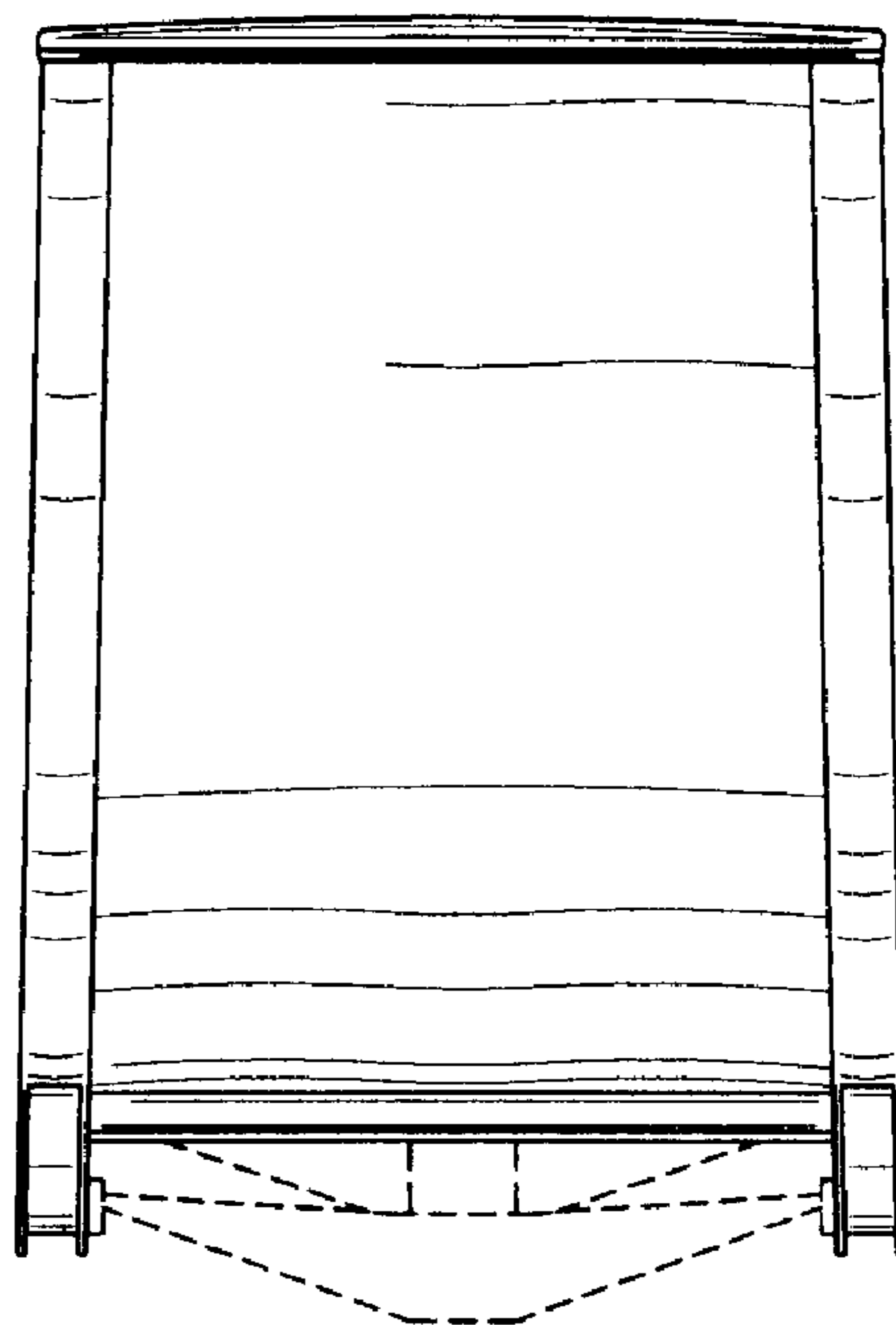

FIG. 14

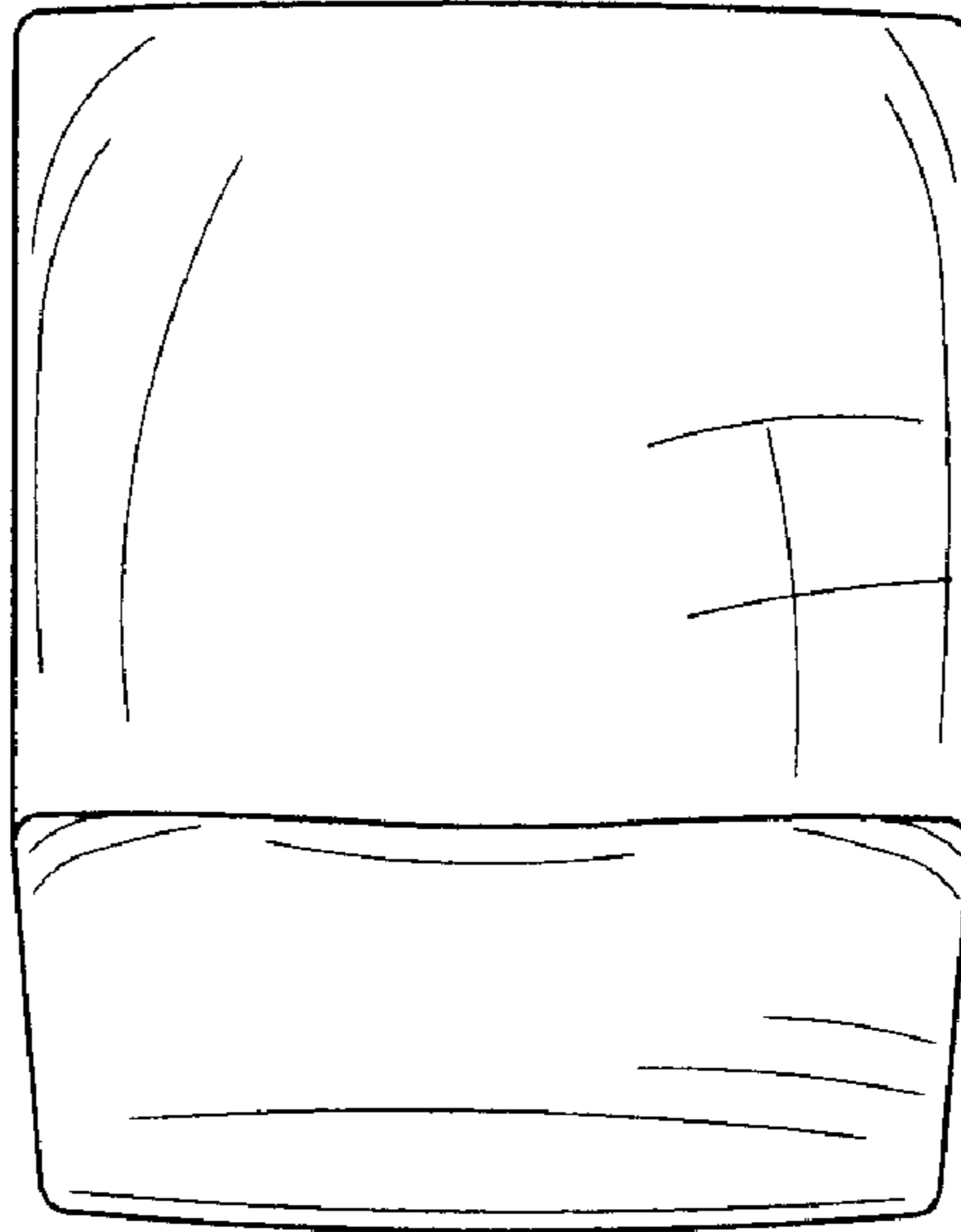

FIG. 15

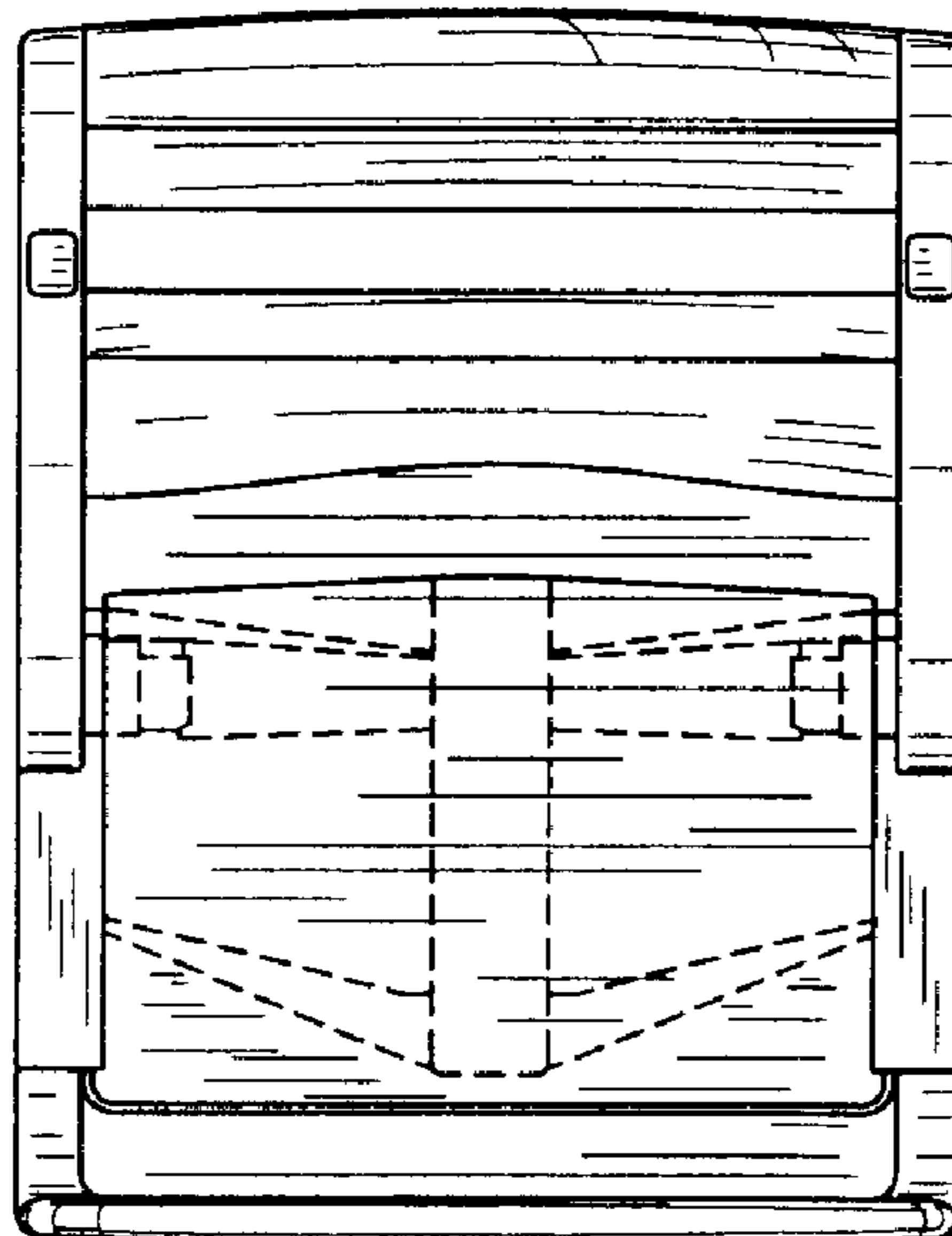

FIG. 16