



US00D535042S

(12) **United States Design Patent**
Nakayama

(10) **Patent No.:** **US D535,042 S**
(45) **Date of Patent:** **** Jan. 9, 2007**

(54) **REAR COMBINATION LAMP**

(75) Inventor: **Ryo Nakayama**, Wako (JP)
(73) Assignee: **Honda Motor Co. Ltd.**, Tokyo (JP)
(**) Term: **14 Years**

(21) Appl. No.: **29/240,635**
(22) Filed: **Oct. 17, 2005**

(30) **Foreign Application Priority Data**

Apr. 18, 2005 (JP) 2005-011415

(51) **LOC (8) Cl.** **26-06**
(52) **U.S. Cl.** **D26/28**
(58) **Field of Classification Search** D26/28-36;
362/459-468, 475-478, 485-487
See application file for complete search history.

(56) **References Cited**

U.S. PATENT DOCUMENTS

D423,126 S * 4/2000 Doss D26/28
D462,467 S * 9/2002 Nakazawa et al. D26/28
D498,012 S * 11/2004 Ballentine D26/28
D523,980 S * 6/2006 Ito et al. D26/28

* cited by examiner

Primary Examiner—Marcus A. Jackson
(74) *Attorney, Agent, or Firm*—Arent Fox PLLC

(57) **CLAIM**

The ornamental design for a rear combination lamp, as shown and described.

DESCRIPTION

FIG. 1 is a front view of a rear combination lamp showing my new design.

FIG. 2 is a rear view thereof.

FIG. 3 is a plan view thereof.

FIG. 4 is a bottom view thereof.

FIG. 5 is a left side view thereof.

FIG. 6 is a right side view thereof.

FIG. 7 is a perspective view thereof as seen from the right front side; and,

FIG. 8 is a perspective view thereof as seen from the left rear side.

The broken line showing of the rear of the rear combination lamp is for illustrative purposes only and forms no part of the claimed design.

1 Claim, 4 Drawing Sheets

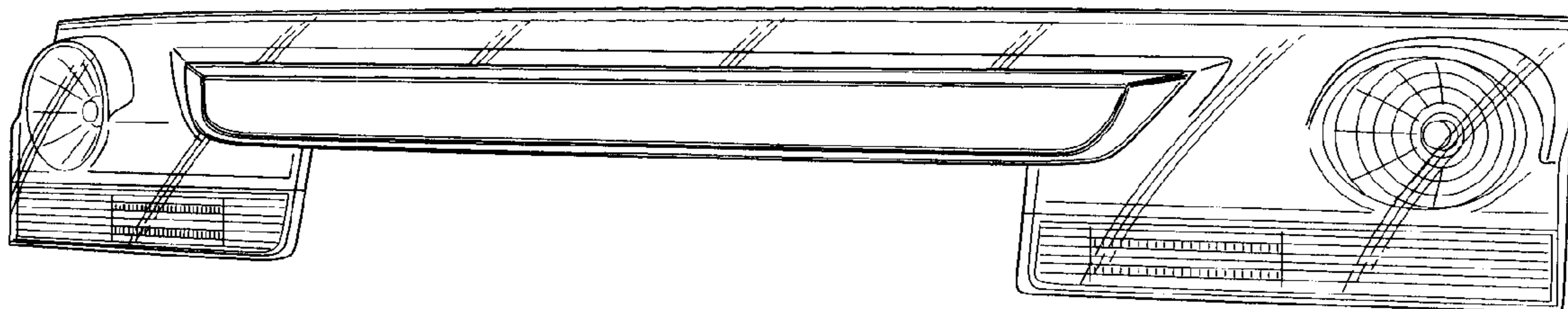

FIG.1

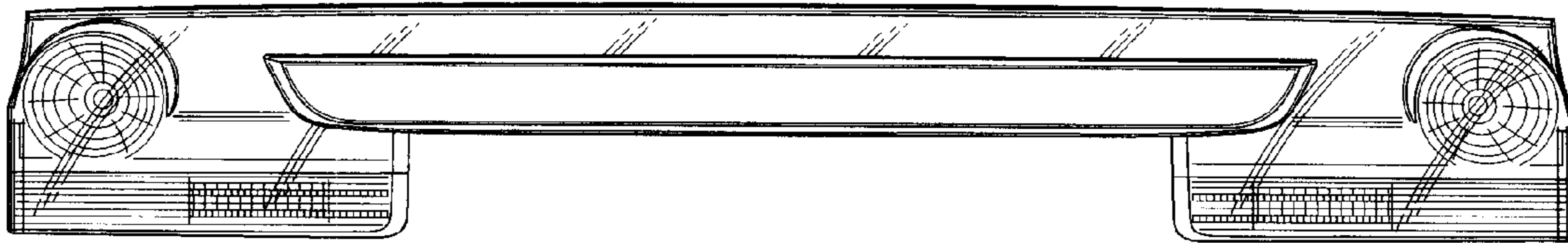

FIG.2

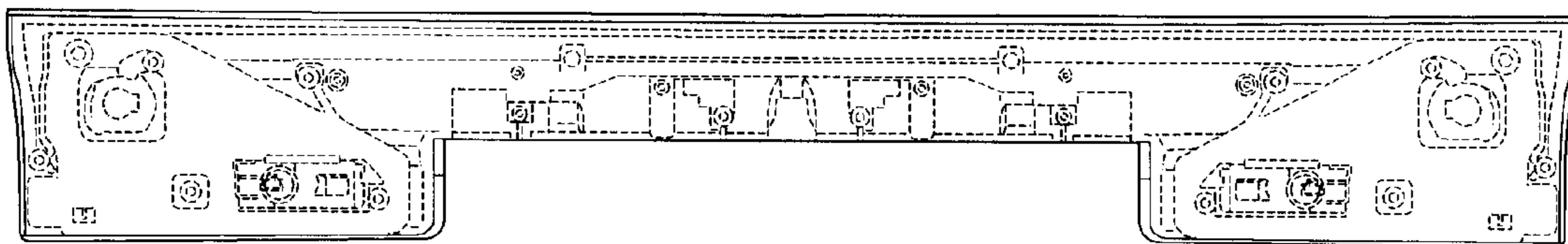

FIG.3

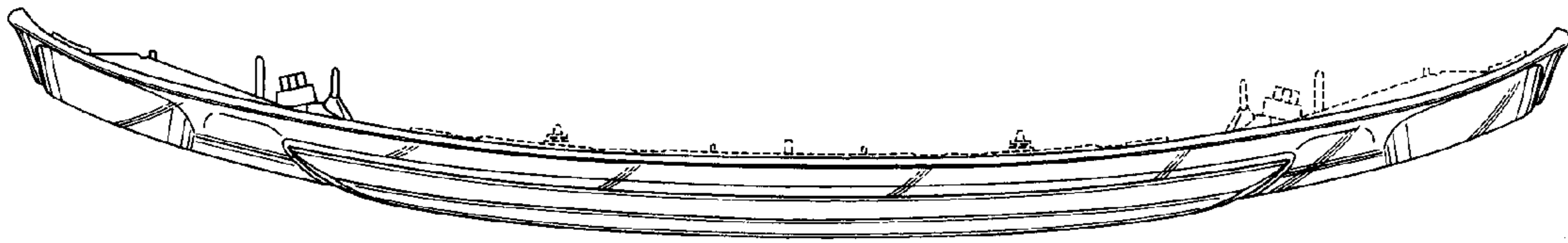

FIG.4

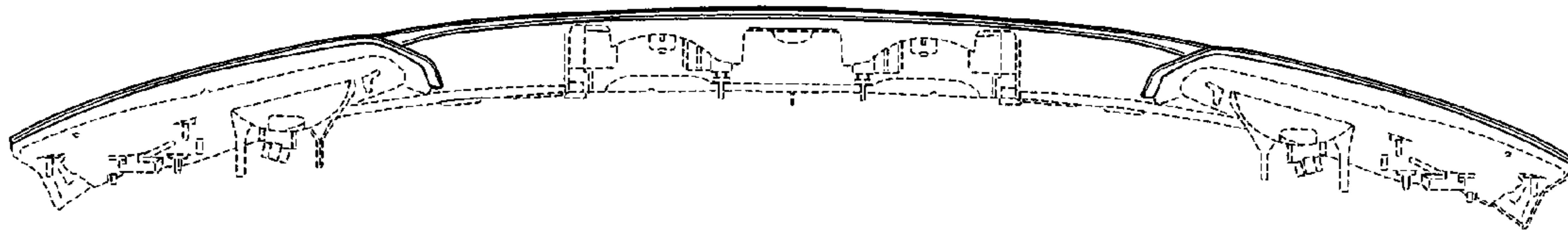

FIG.5

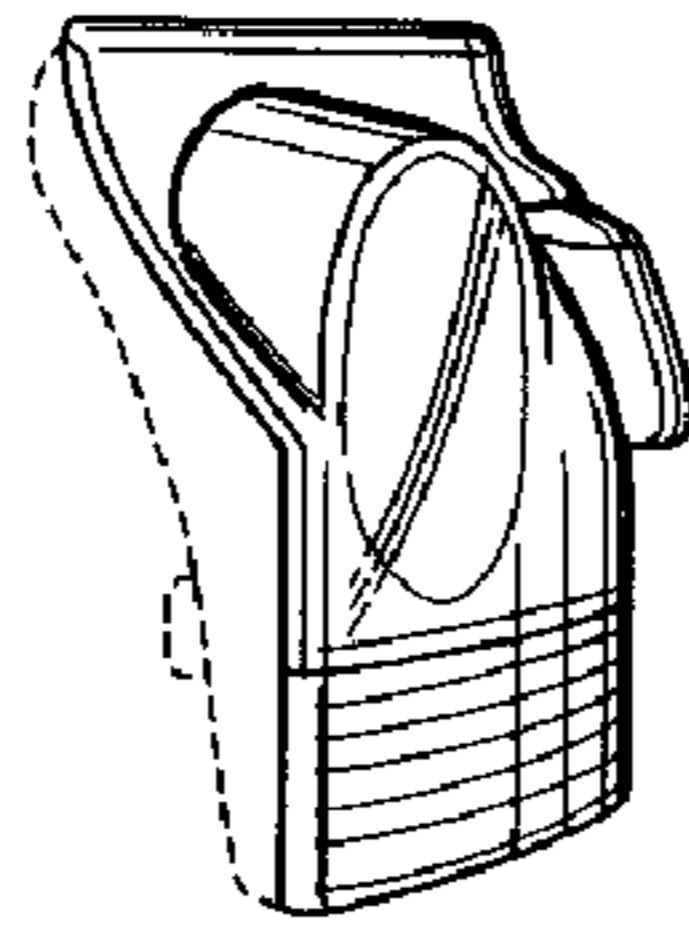

FIG.6

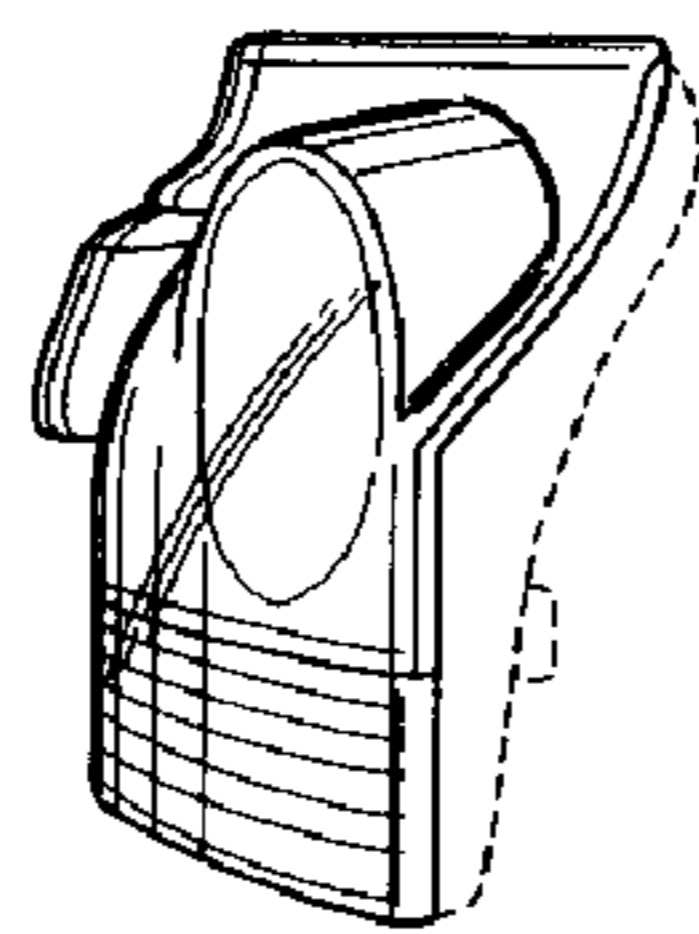

FIG.7



FIG.8

