



US00D534843S

(12) **United States Design Patent**
Higashi

(10) **Patent No.:** **US D534,843 S**
(45) **Date of Patent:** **** Jan. 9, 2007**

(54) **PORTION OF A GRIP**

(75) Inventor: **Yumiko Higashi**, Niizashi Saitama (JP)

(73) Assignee: **Honda Access Corp.**, Saitama (JP)

(**) Term: **14 Years**

(21) Appl. No.: **29/231,797**

(22) Filed: **Jun. 10, 2005**

(30) **Foreign Application Priority Data**

Jan. 6, 2005 (JP) 2005-000080

(51) **LOC (8) Cl.** **12-11**

(52) **U.S. Cl.** **D12/174**

(58) **Field of Classification Search** D12/110,
D12/114, 178, 174; 180/219, 321, 333; 74/551.8,
74/551.9, 488, 489, 484 R; 200/4, 61.85,
200/157, 293.1, 553, 310, 313, 314; D13/126,
D13/158; D8/303

See application file for complete search history.

(56) **References Cited**

U.S. PATENT DOCUMENTS

4,191,866 A * 3/1980 Nakajima et al. 200/4

D265,816 S * 8/1982 Matre D12/174

4,455,463 A * 6/1984 Rohl 200/61.85

* cited by examiner

Primary Examiner—Alan P. Douglas

Assistant Examiner—Linda Brooks

(74) *Attorney, Agent, or Firm*—Westerman, Hattori,
Daniels & Adrian, LLP

(57) **CLAIM**

The ornamental design for a portion of a grip, as shown and described.

DESCRIPTION

FIG. 1 is a perspective view of a portion of a grip;

FIG. 2 is a perspective view thereof;

FIG. 3 is a plan view thereof;

FIG. 4 is a frontal view thereof;

FIG. 5 is a bottom view thereof;

FIG. 6 is a back view thereof;

FIG. 7 is a right side view thereof;

FIG. 8 is a left side view thereof; and,

FIG. 9 is a view thereof on a reduced scale showing the design in a position of use on a portion of a motorcycle.

The broken lines showing the remainder of the grip in FIGS. 1–8, and the portion of a motorcycle in FIG. 9, are for illustrative purposes only and form no part of the claimed design. The broken lines immediately adjacent the shaded areas represent the boundaries of the claimed design and form no part thereof.

1 Claim, 5 Drawing Sheets

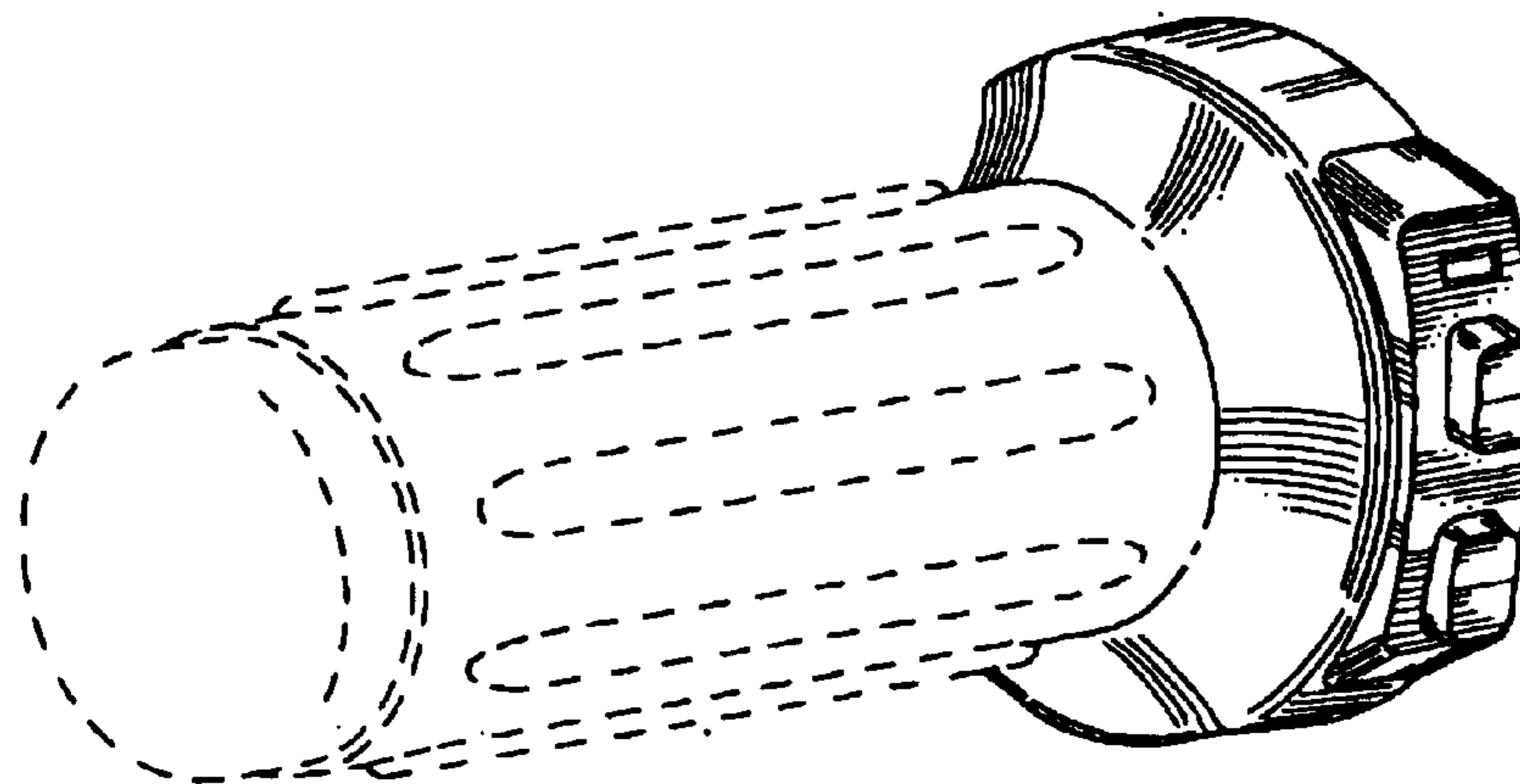

FIG. 1

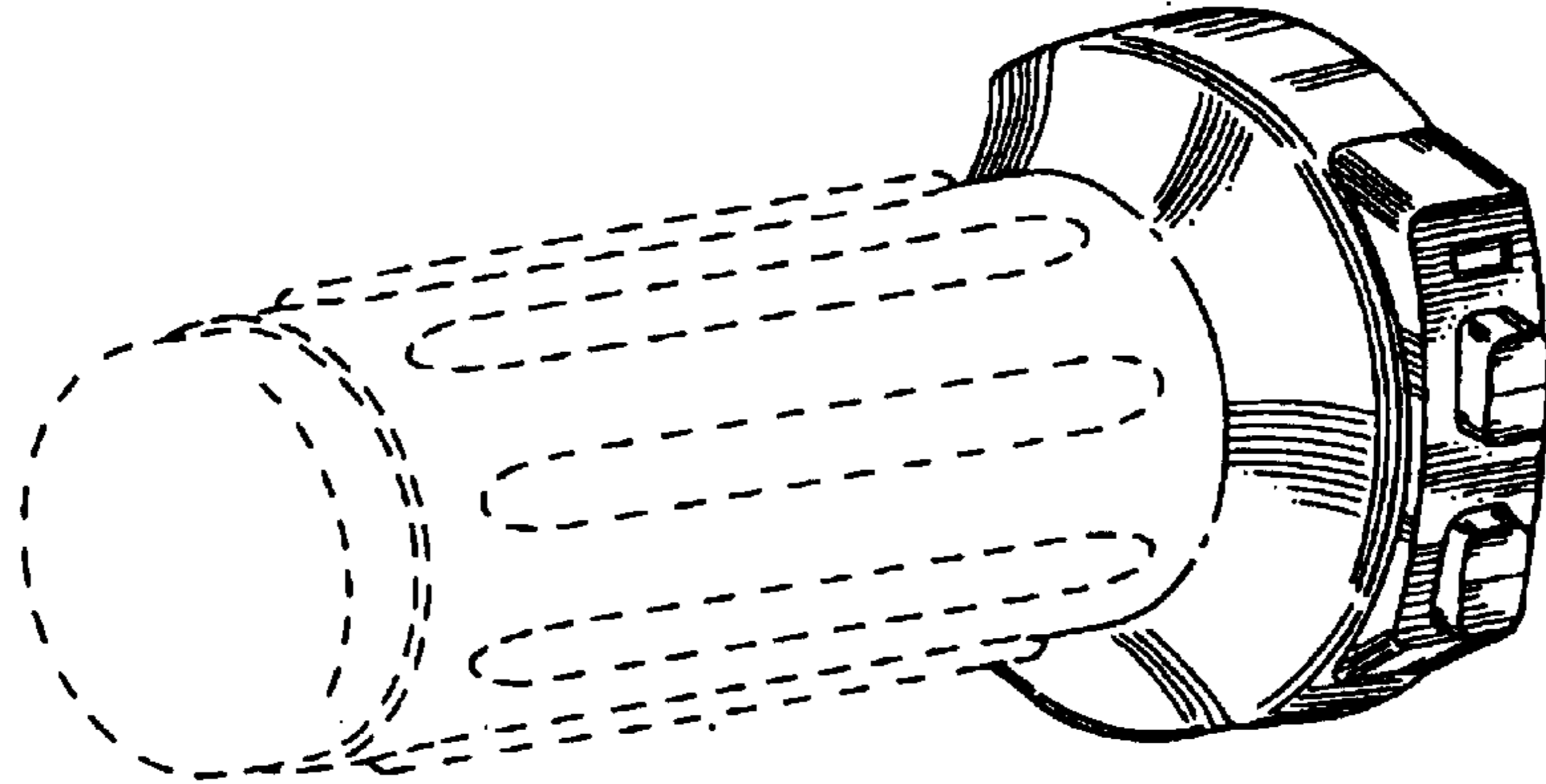

FIG. 2

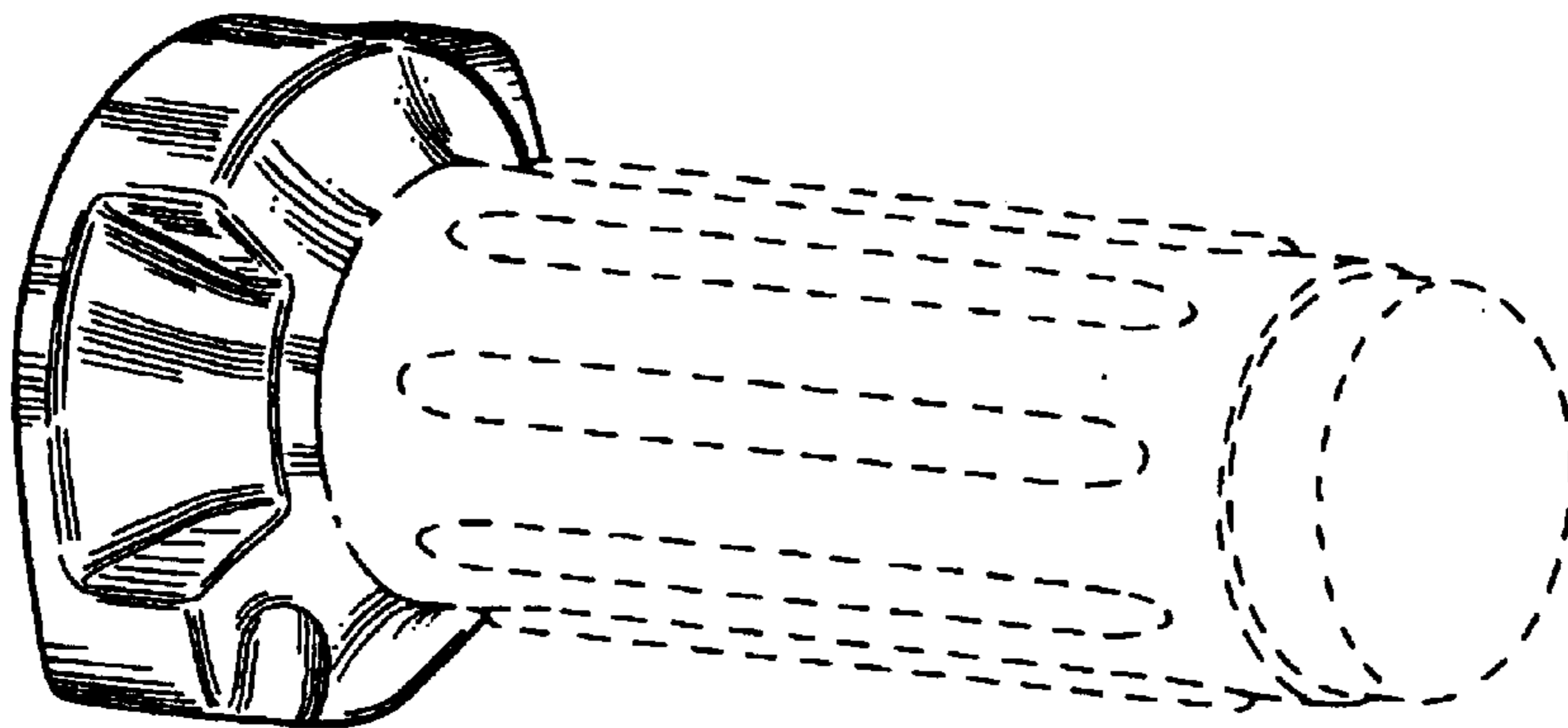

FIG. 3

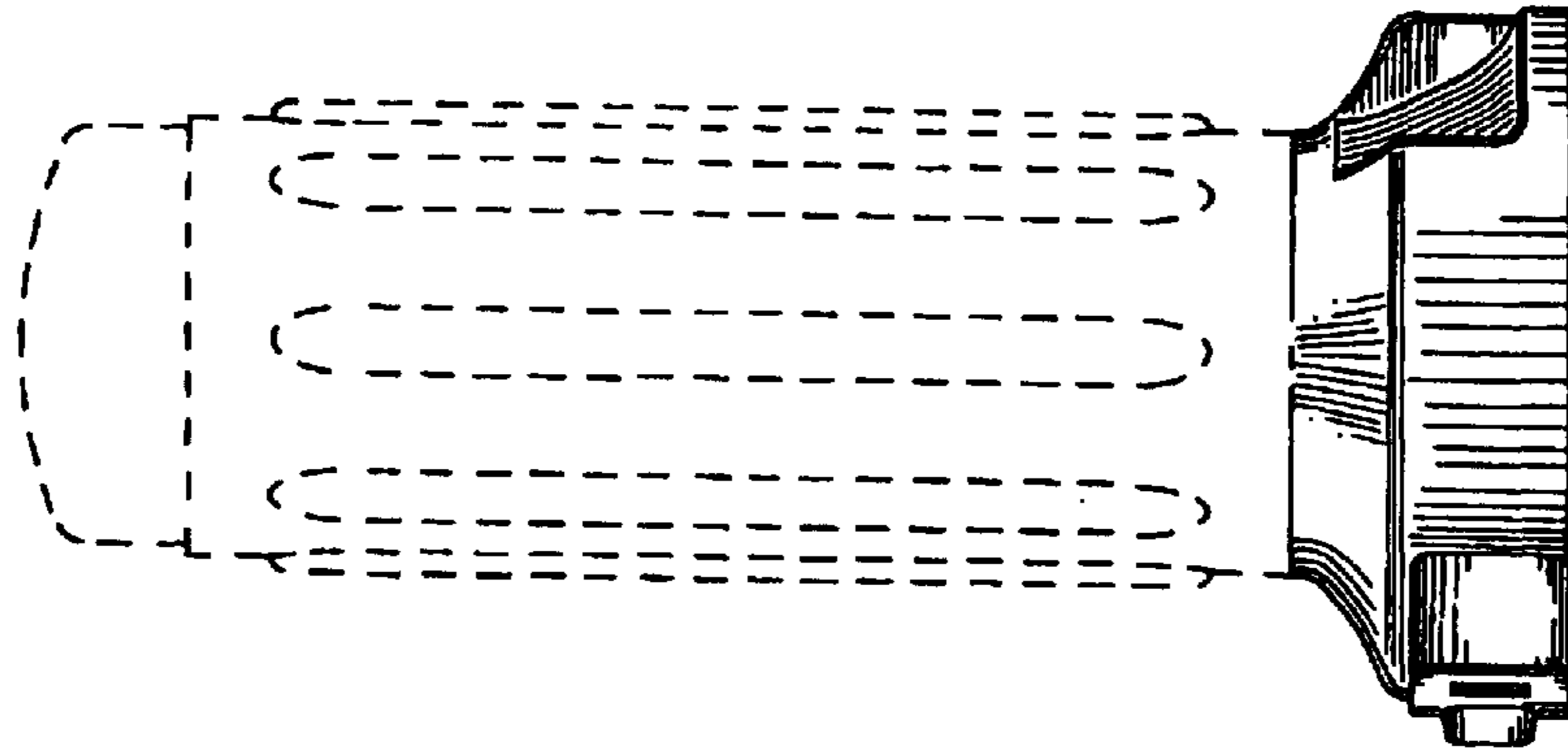

FIG. 4

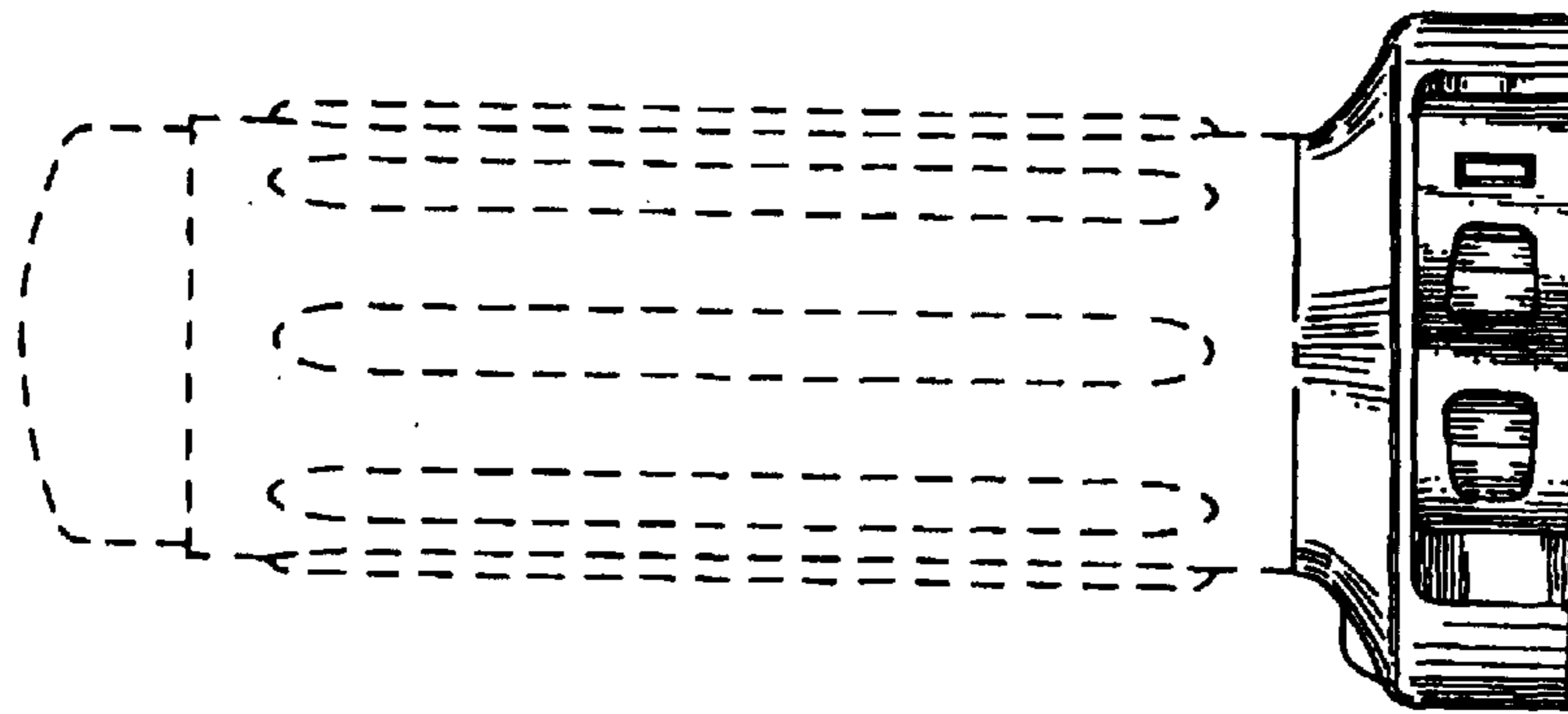

FIG. 5

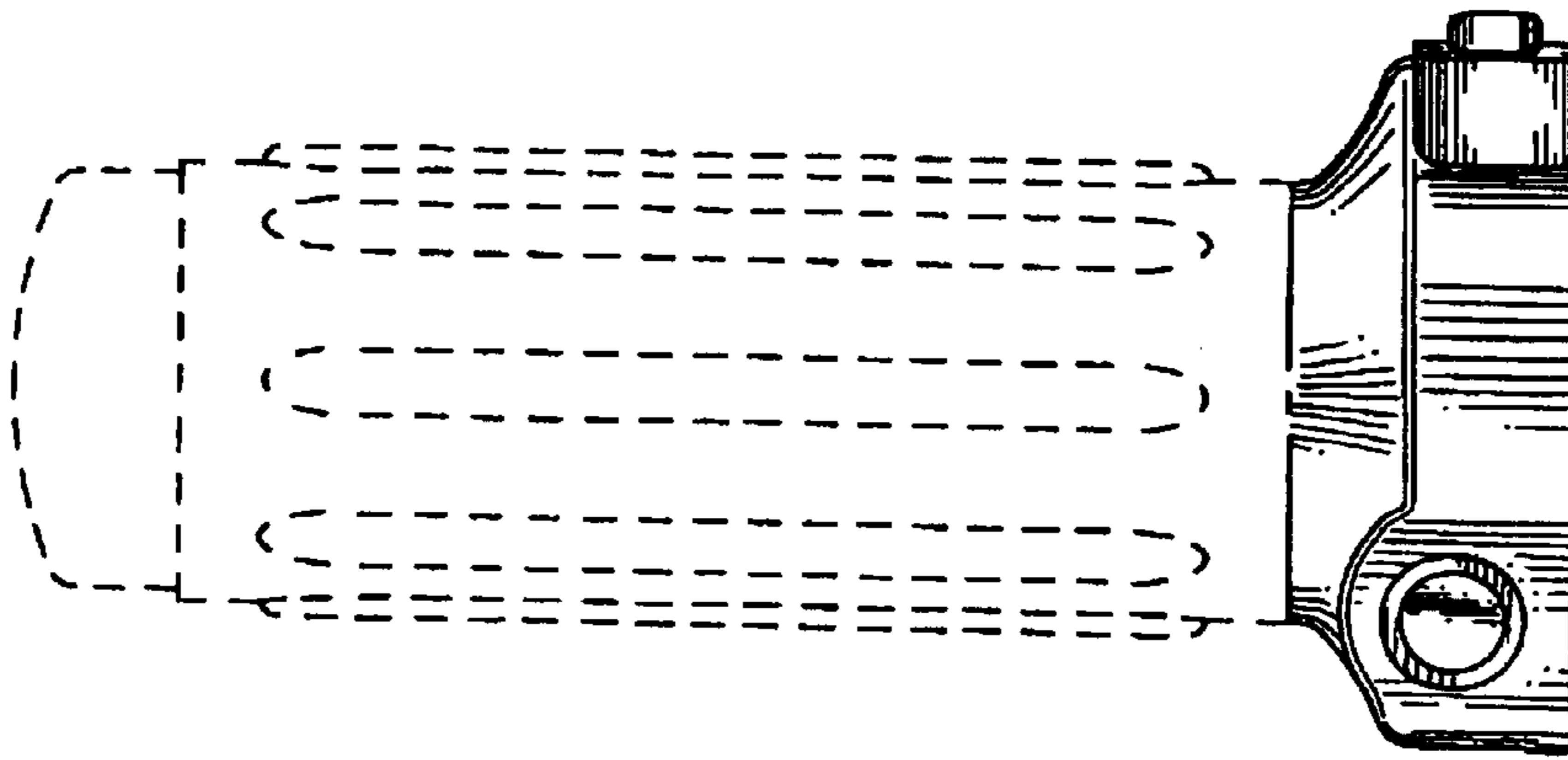

FIG. 6

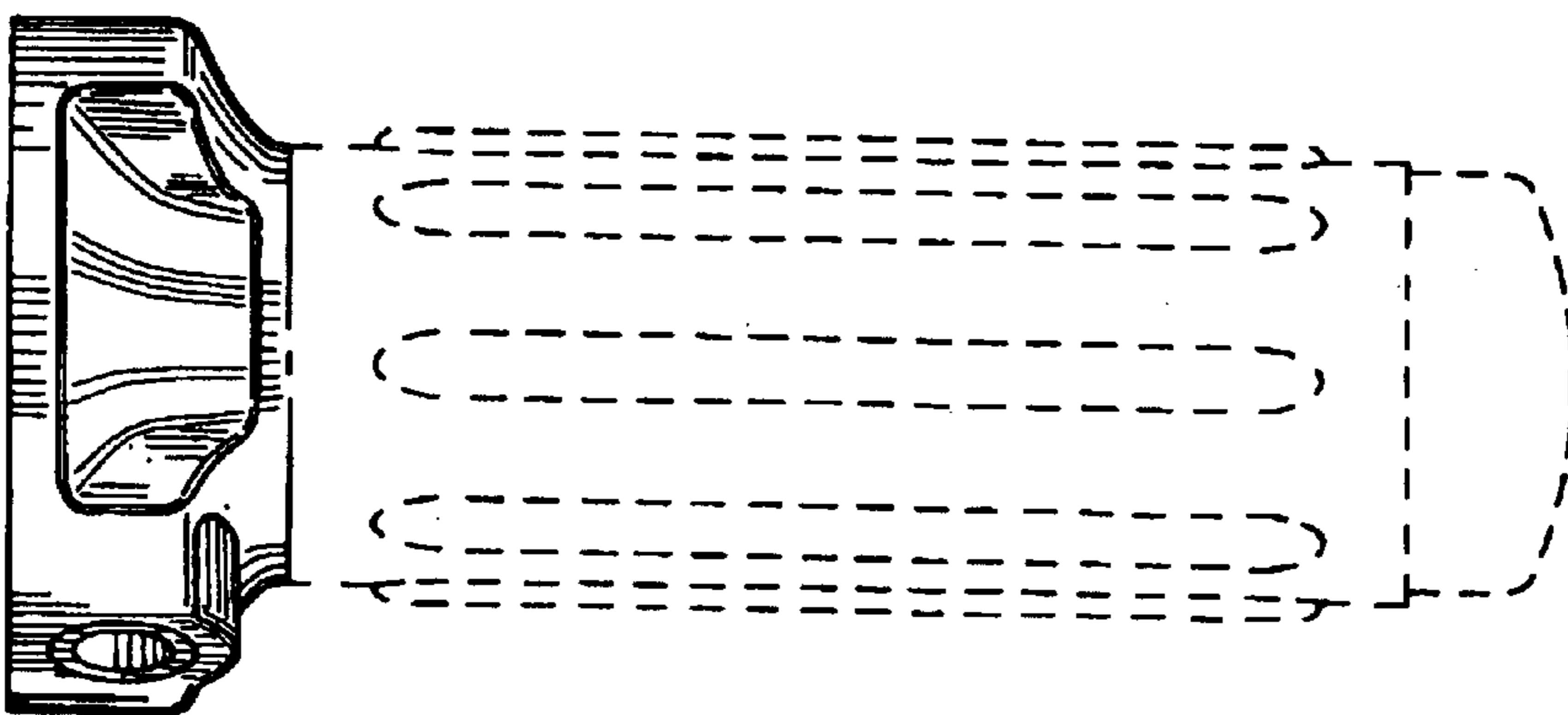

FIG. 7

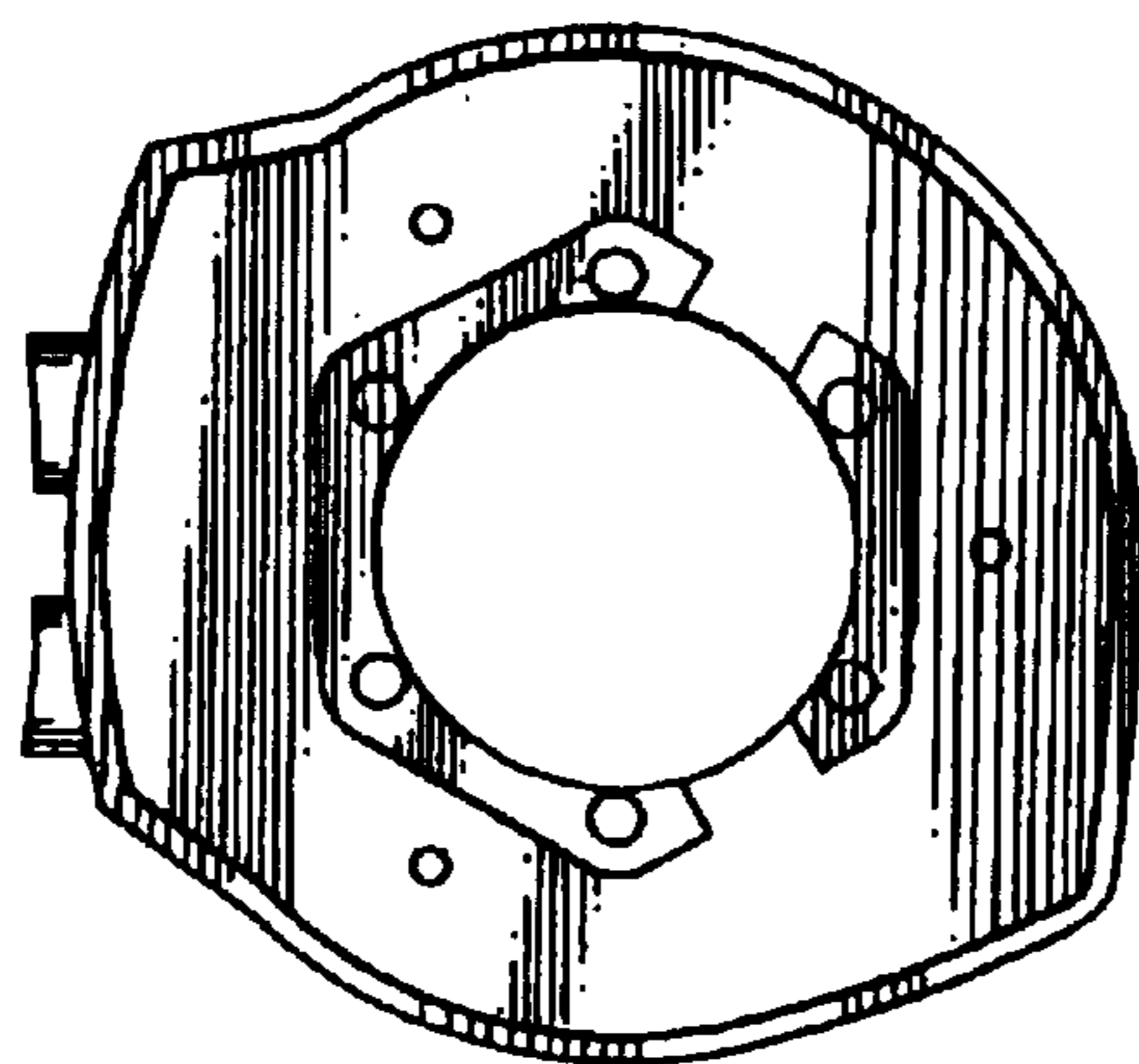

FIG. 8

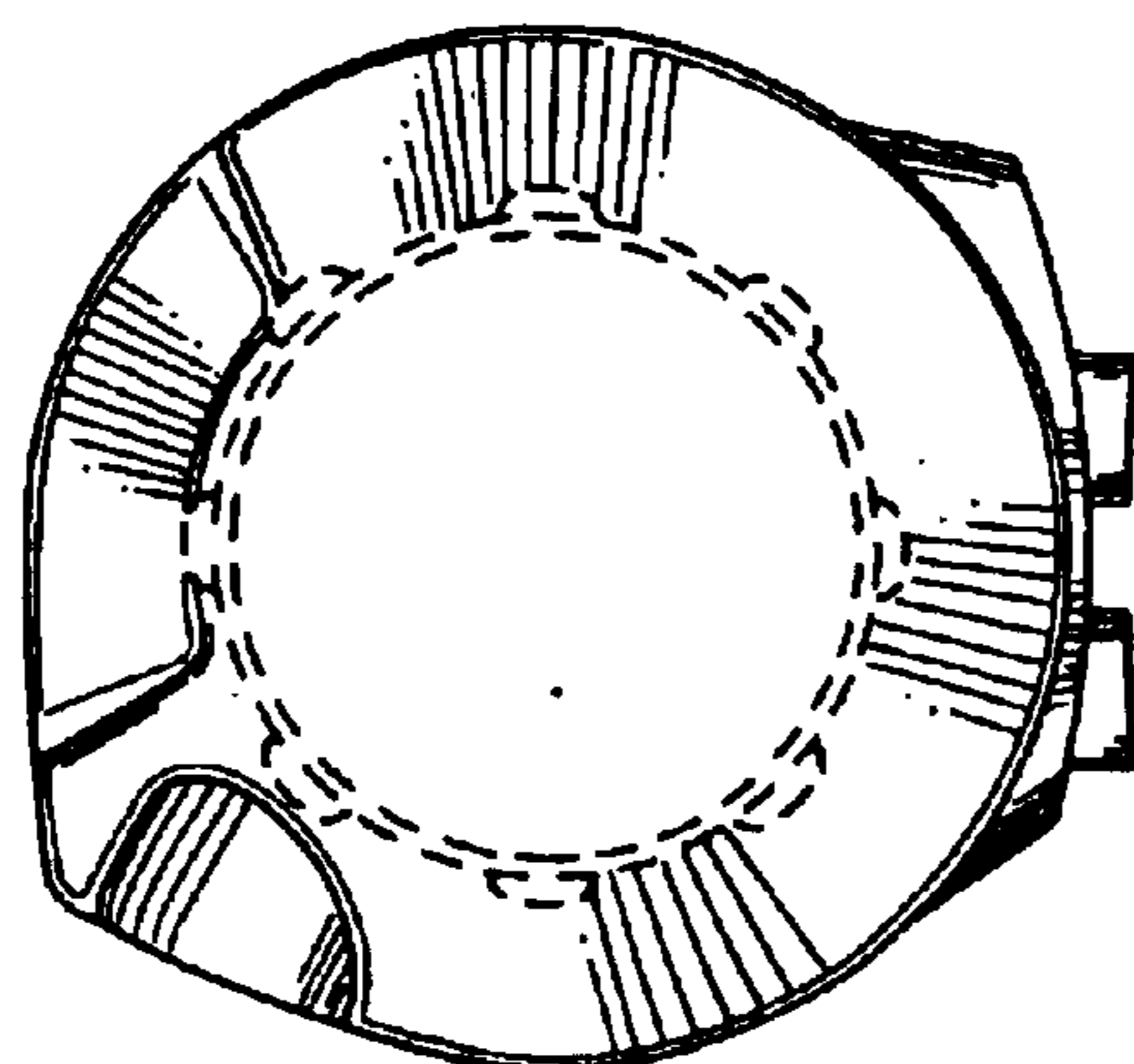

FIG. 9

