



US00D534755S

(12) **United States Design Patent**  
**Knight**

(10) **Patent No.:** **US D534,755 S**

(45) **Date of Patent:** **\*\* Jan. 9, 2007**

(54) **BARBEQUE OVEN**

(75) Inventor: **David B. Knight**, Cape Girardeau, MO (US)

(73) Assignee: **David B. Knight & Associates, Inc.**, Cape Girardeau, MO (US)

(\*\*) Term: **14 Years**

(21) Appl. No.: **29/228,979**

(22) Filed: **Apr. 29, 2005**

(51) **LOC (8) Cl.** ..... **07-02**

(52) **U.S. Cl.** ..... **D7/332**

(58) **Field of Classification Search** ..... D7/332-338, D7/339, 347-348, 402-405; 99/339-340, 99/420, 421 A, 421 H, 421 M, 422, 423, 99/427, 443 C, 441, 443 R, 445, 447-448, 99/482, 450; 126/4, 9 R, 25 R, 25 A, 25 AA, 126/37 R, 37 B, 40, 41 R, 50; D99/29

See application file for complete search history.

**OTHER PUBLICATIONS**

Ole Hickory Pits product specification Model EL-EC, Apr. 18, 2005.

Ole Hickory Pits product specification Model EL-ED, Apr. 18, 2005.

Ole Hickory Pits product specification Model EL-EW, Apr. 18, 2005.

Ole Hickory Pits product specification Model EL-IB, Apr. 18, 2005.

Ole Hickory Pits product specification Model EL, Apr. 18, 2005.

Ole Hickory Pits product specification Model SSJ-AE, Apr. 18, 2005.

Ole Hickory Pits product specification Model SSE, Apr. 18, 2005.

\* cited by examiner

*Primary Examiner*—Ruth McInroy

(74) *Attorney, Agent, or Firm*—Senniger Powers

(57) **CLAIM**

The ornamental design for a barbecue oven, as shown and described.

(56) **References Cited**

**U.S. PATENT DOCUMENTS**

2,510,856	A	6/1950	Bettencourt	
2,558,569	A	6/1951	Koch	
D175,820	S	* 10/1955	Aaronson	D7/338
D177,055	S	* 3/1956	Levin	D7/338
2,833,201	A	5/1958	Simank	
D185,251	S	* 5/1959	Wilson	D7/338
2,956,497	A	10/1960	Bernstein	
D203,087	S	* 11/1965	Vaughan	D7/338
D206,700	S	* 1/1967	Wilson	D7/338
D238,897	S	* 2/1976	Wilson	D7/338
D254,308	S	* 2/1980	Polak et al.	D7/338
D292,863	S	* 11/1987	Johansson	D7/338
D349,419	S	* 8/1994	Koopman	D7/338
D369,503	S	* 5/1996	Meister et al.	D7/338
D418,005	S	* 12/1999	Morris	D7/338
D471,756	S	* 3/2003	Joosten	D7/338
6,810,792	B1	11/2004	Knight	

**DESCRIPTION**

FIG. 1 is a perspective of a first embodiment of the barbecue oven;

FIG. 2 is a front elevation thereof;

FIG. 3 is a right side elevation thereof;

FIG. 4 is a left side elevation thereof;

FIG. 5 is a rear elevation thereof;

FIG. 6 is a top plan thereof;

FIG. 7 is a perspective of a second embodiment of the barbecue oven having a pair of doors;

FIG. 8 is a front elevation view of FIG. 7, the right, left and rear views being substantially identical to the corresponding views of the first embodiment;

FIG. 9 is a top plan view of FIG. 7;

FIG. 10 is a perspective view of FIG. 7 with the doors in an open position;

FIG. 11 is a perspective view of a third embodiment of the barbecue oven having a single door;

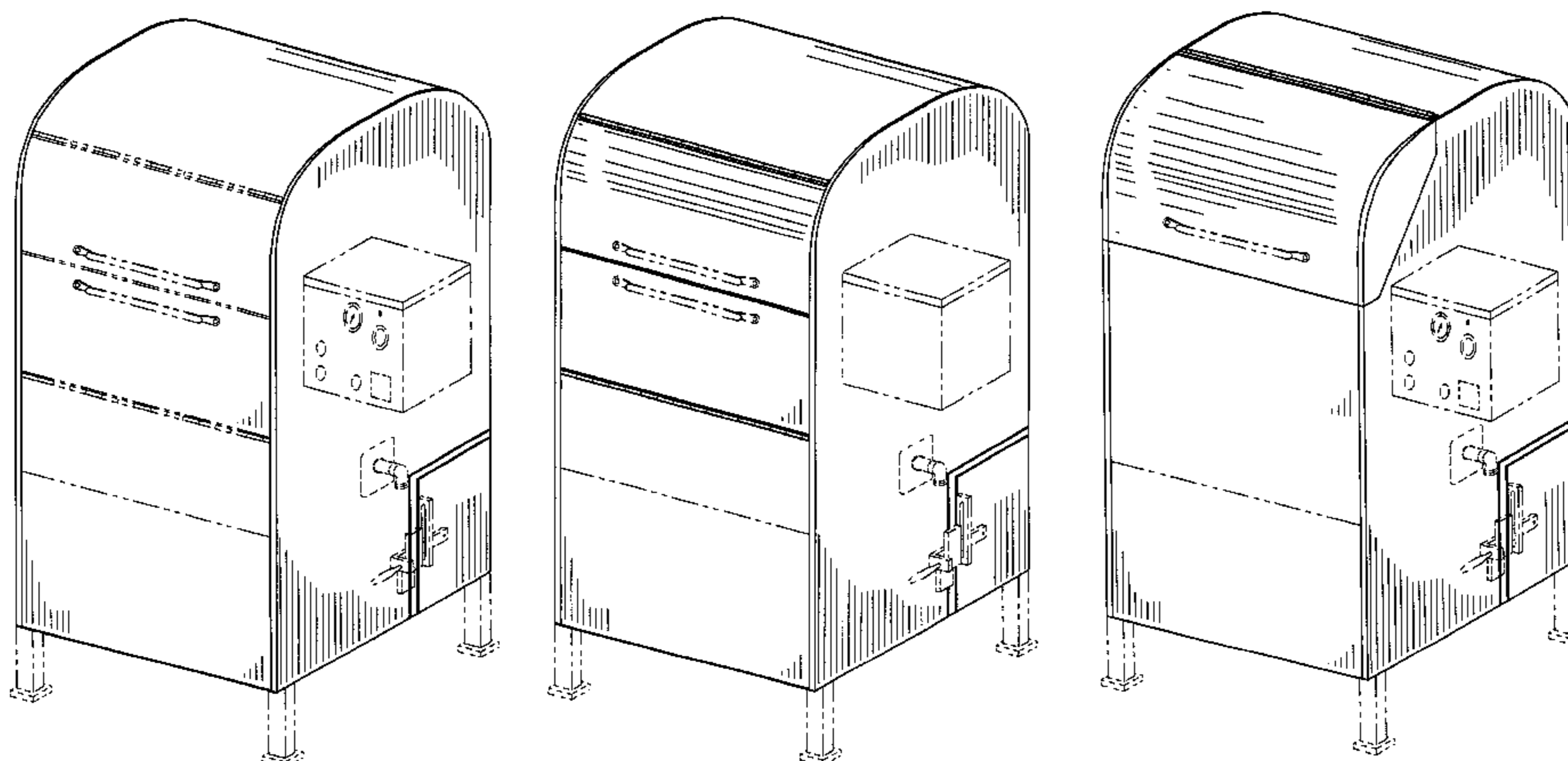

FIG. 12 is a front elevation view of FIG. 11, the right, left and rear views being substantially identical to the corresponding views of the first embodiment;

FIG. 13 is a perspective view of FIG. 11 with the door opened;

FIG. 14 is a perspective view of a fourth embodiment of the barbeque oven having a door on the side;

FIG. 15 is a front elevation view of FIG. 14;

FIG. 16 is a right side elevation view of FIG. 14;

FIG. 17 is a perspective view of FIG. 14 with the door in an open position;

FIG. 18 is a perspective view of a fifth embodiment of the barbeque oven having a single curved door;

FIG. 19 is a front elevation view of FIG. 18, the rear and top views being substantially identical to the corresponding views of the first embodiment;

FIG. 20 is a right side elevation view of FIG. 18;

FIG. 21 is a left side elevation view of FIG. 18; and,

FIG. 22 is a perspective view of FIG. 18 with the door open.

The broken lines shown in the drawings indicate structure and features which form no part of the claimed design.

**1 Claim, 22 Drawing Sheets**

FIG. 1

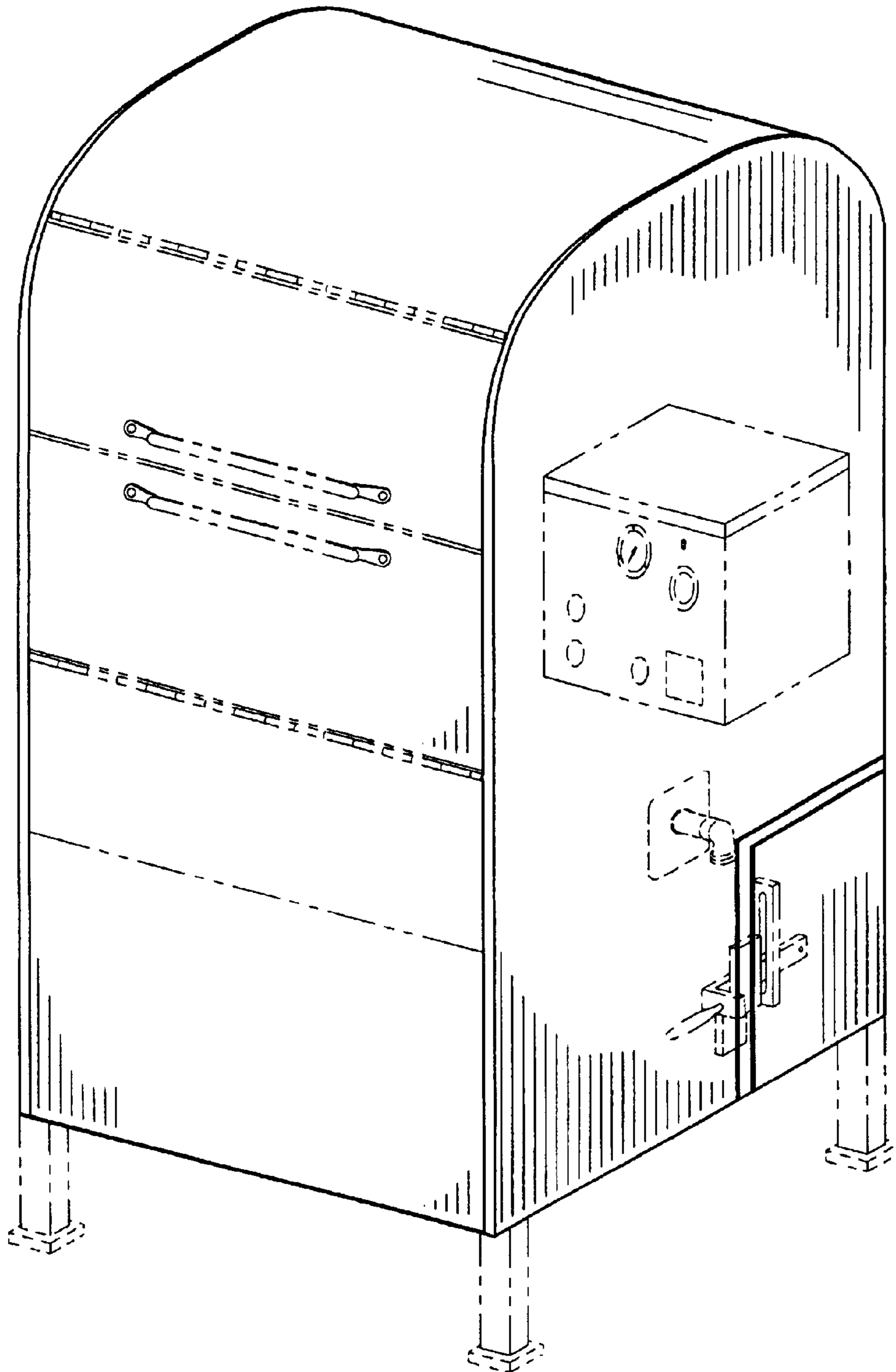

FIG. 2

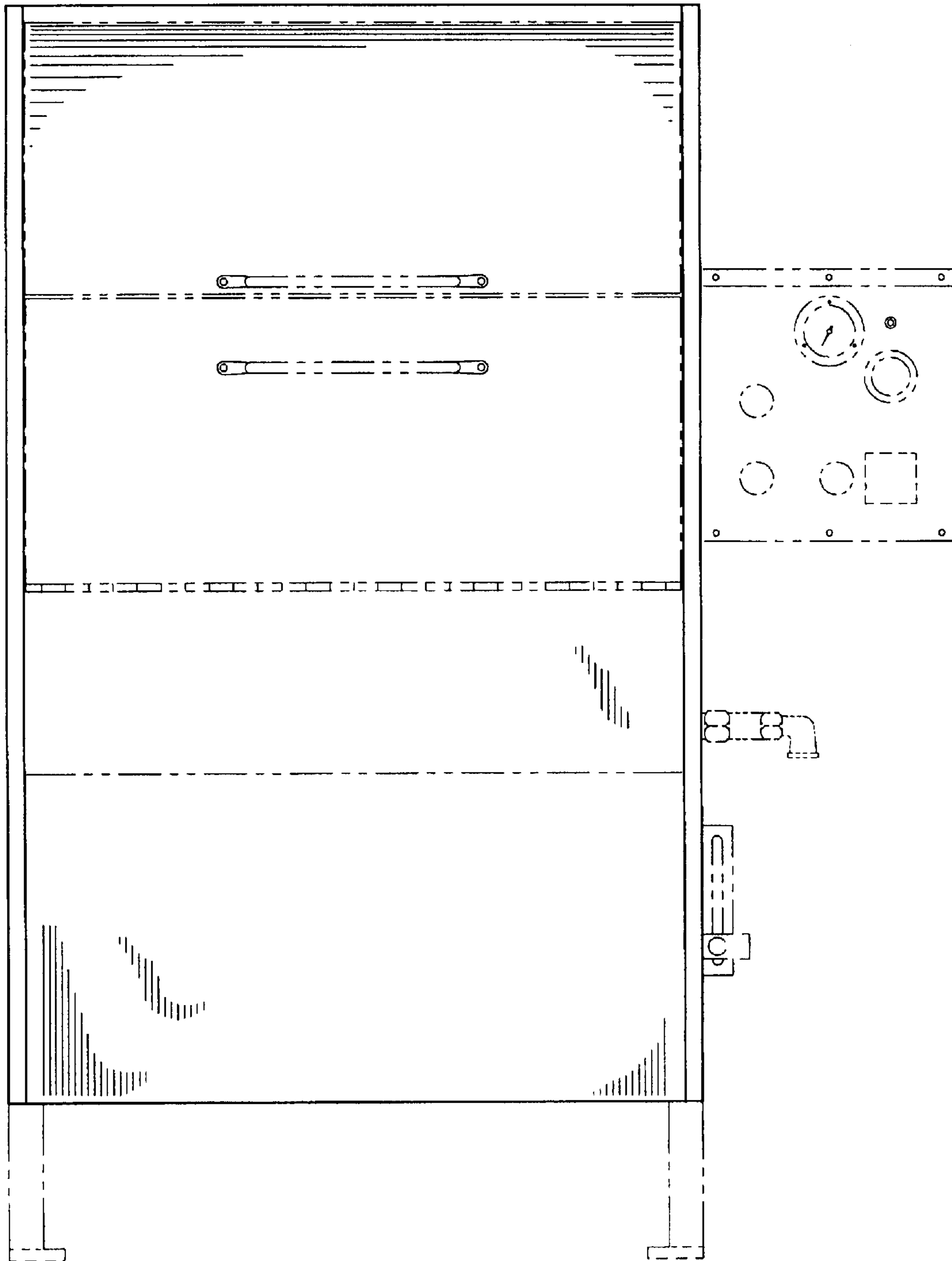

FIG. 3

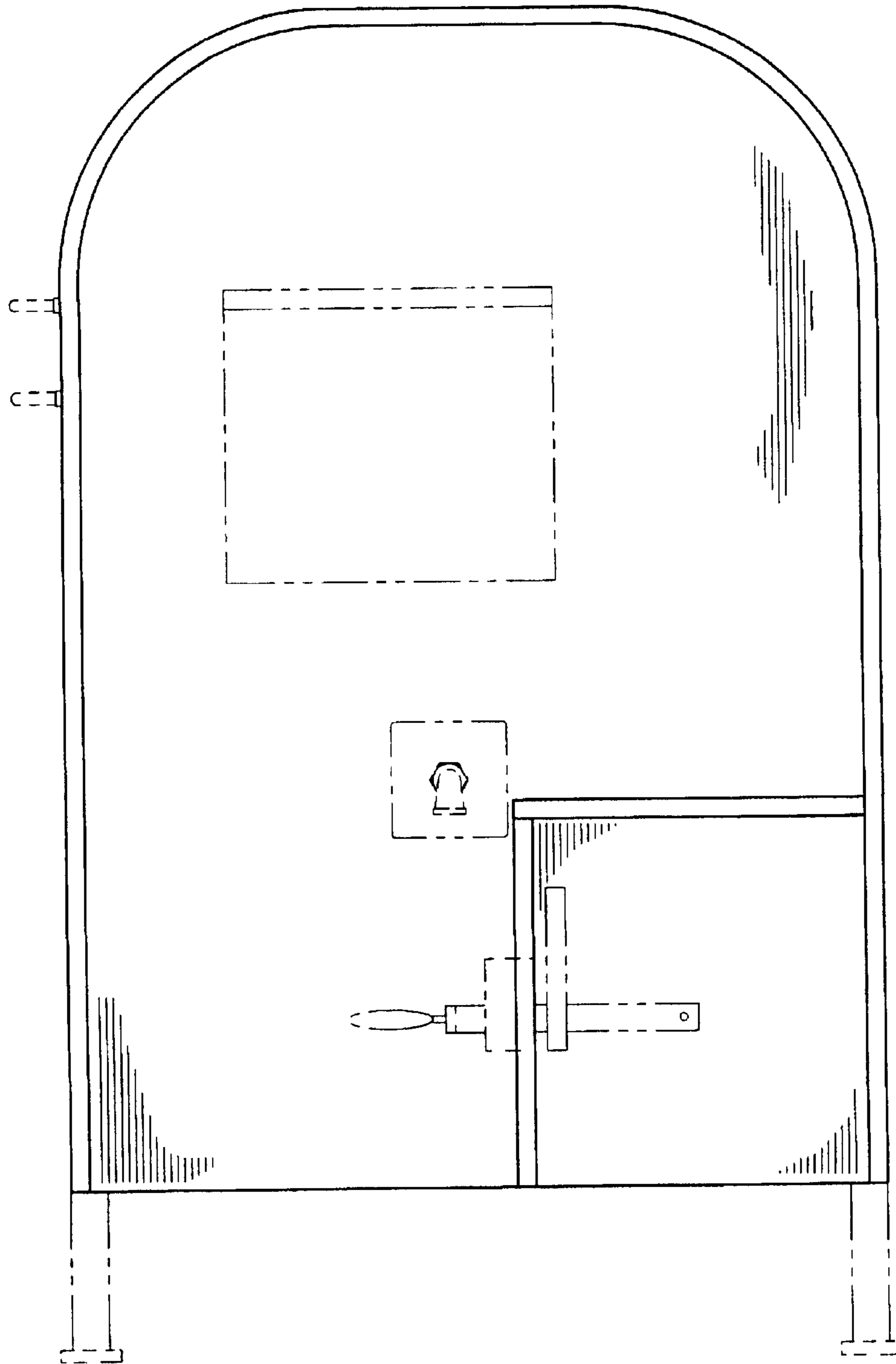

FIG. 4

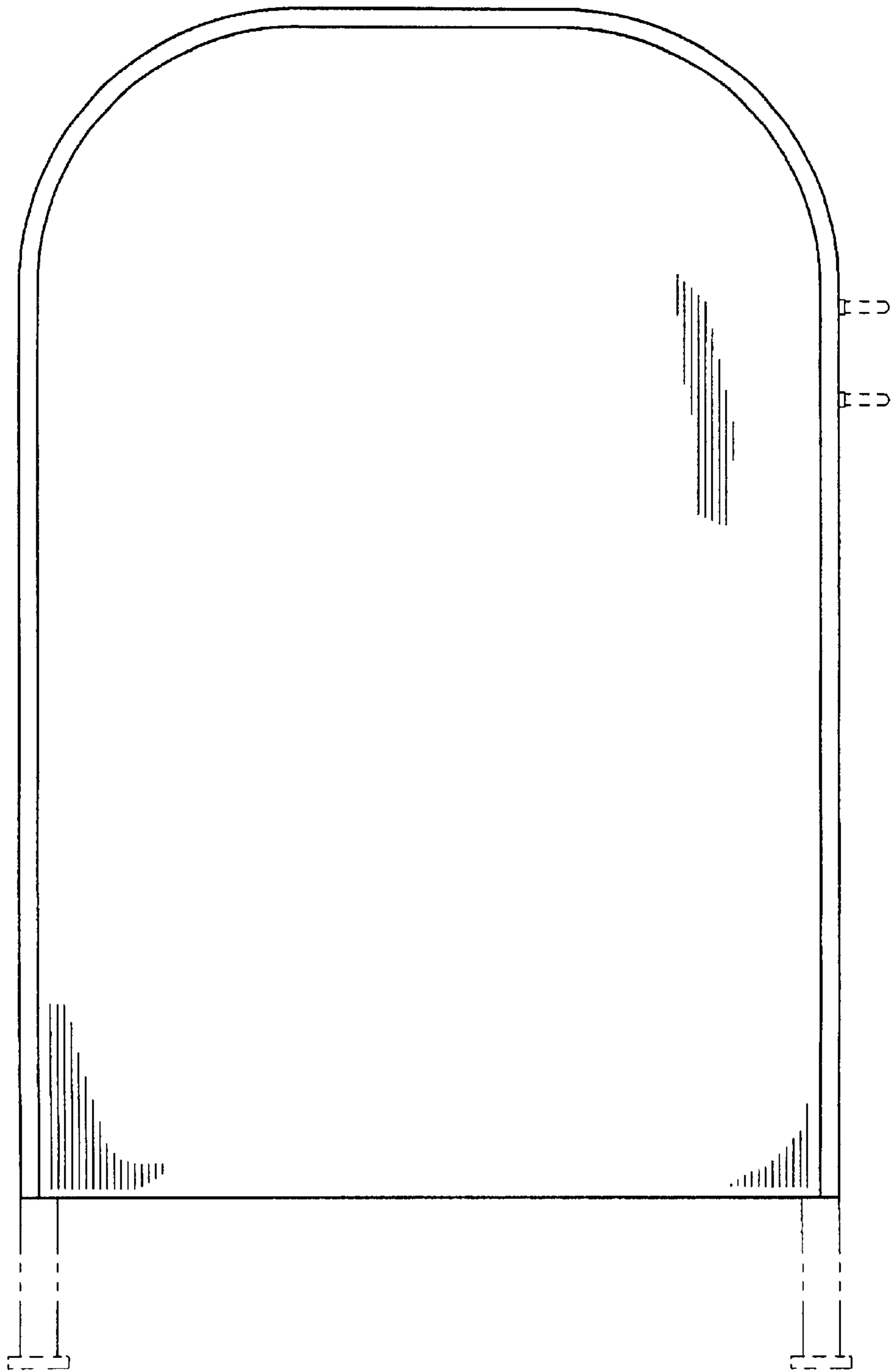

FIG. 5

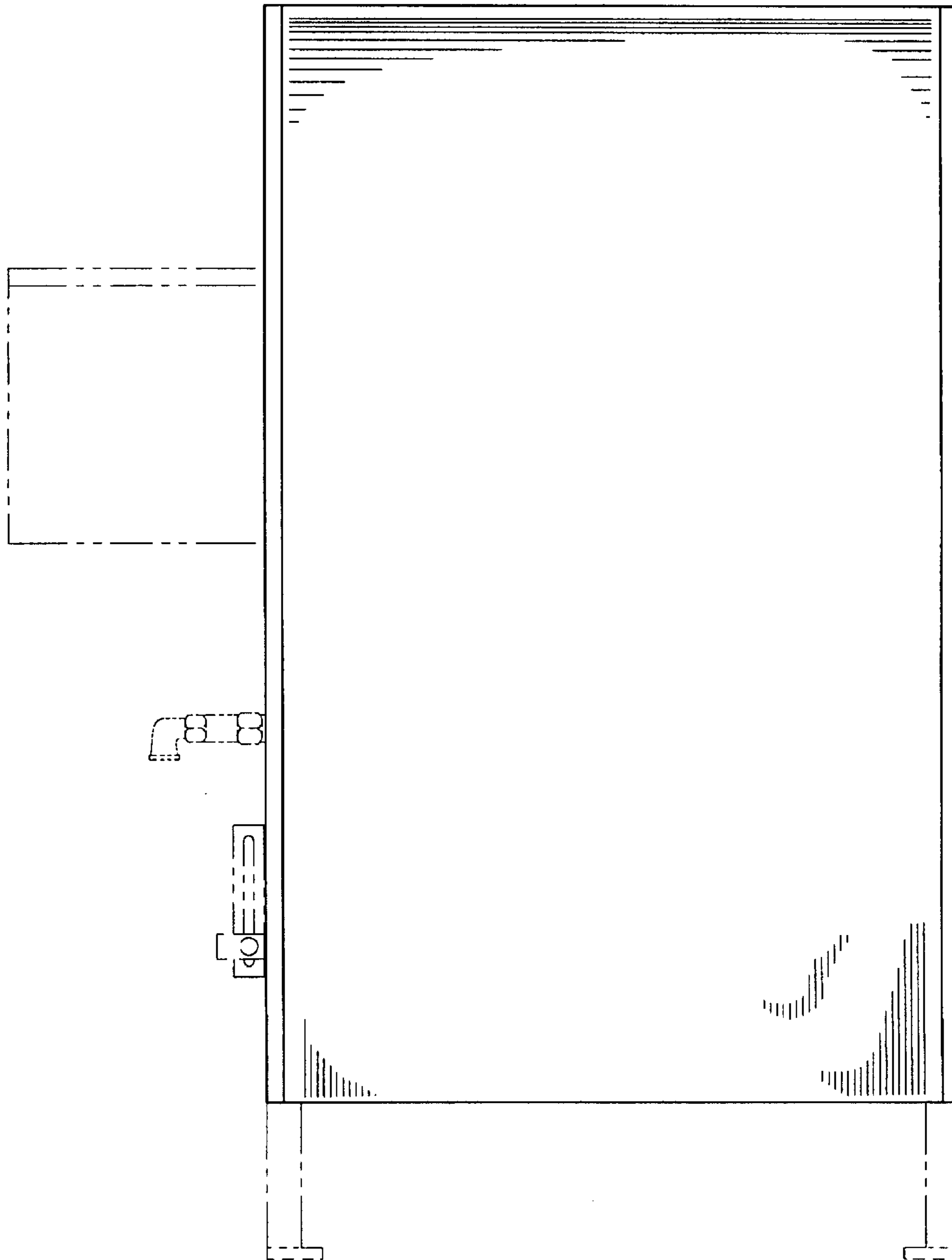



FIG. 6

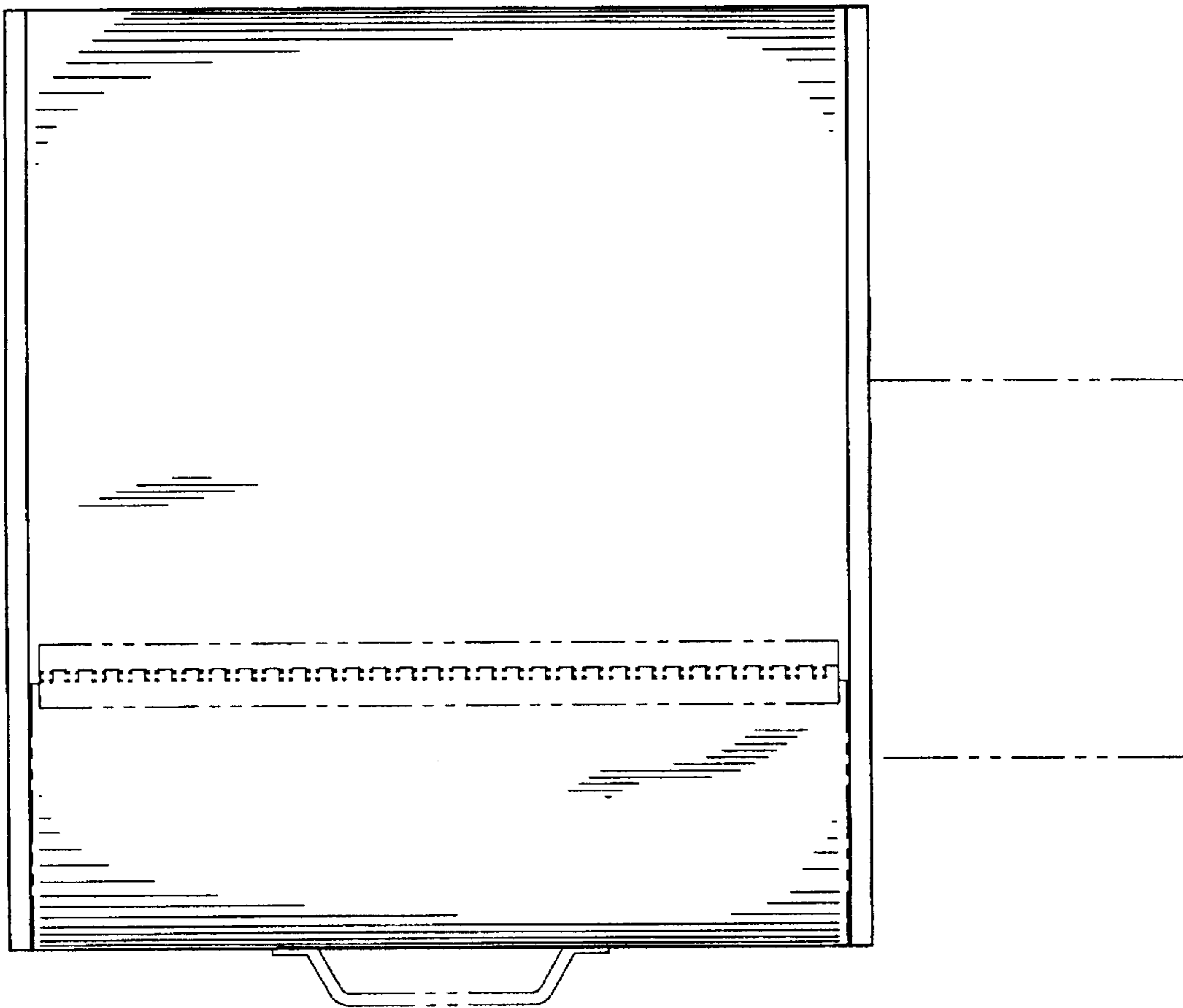



FIG. 7

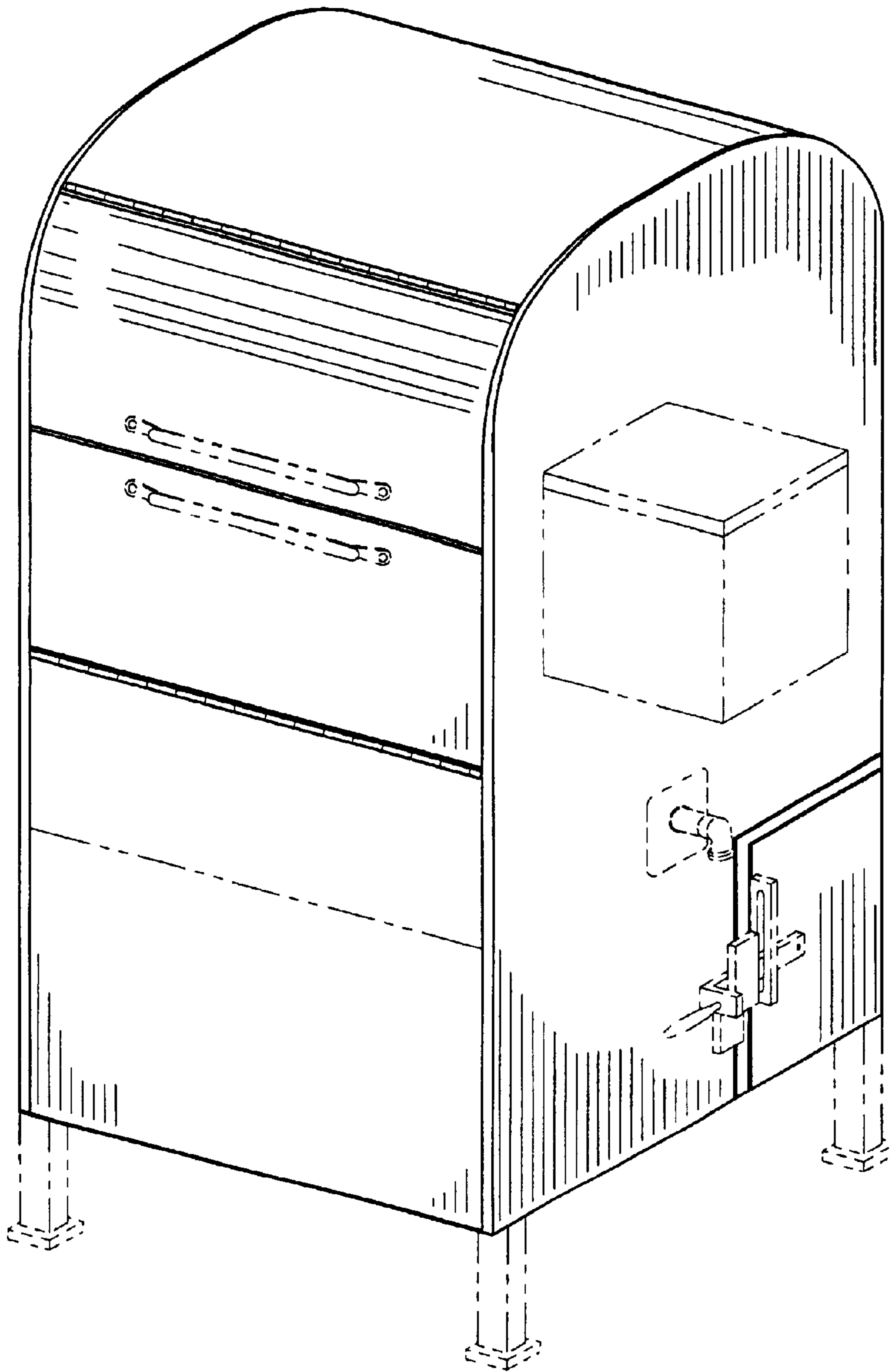

FIG. 8

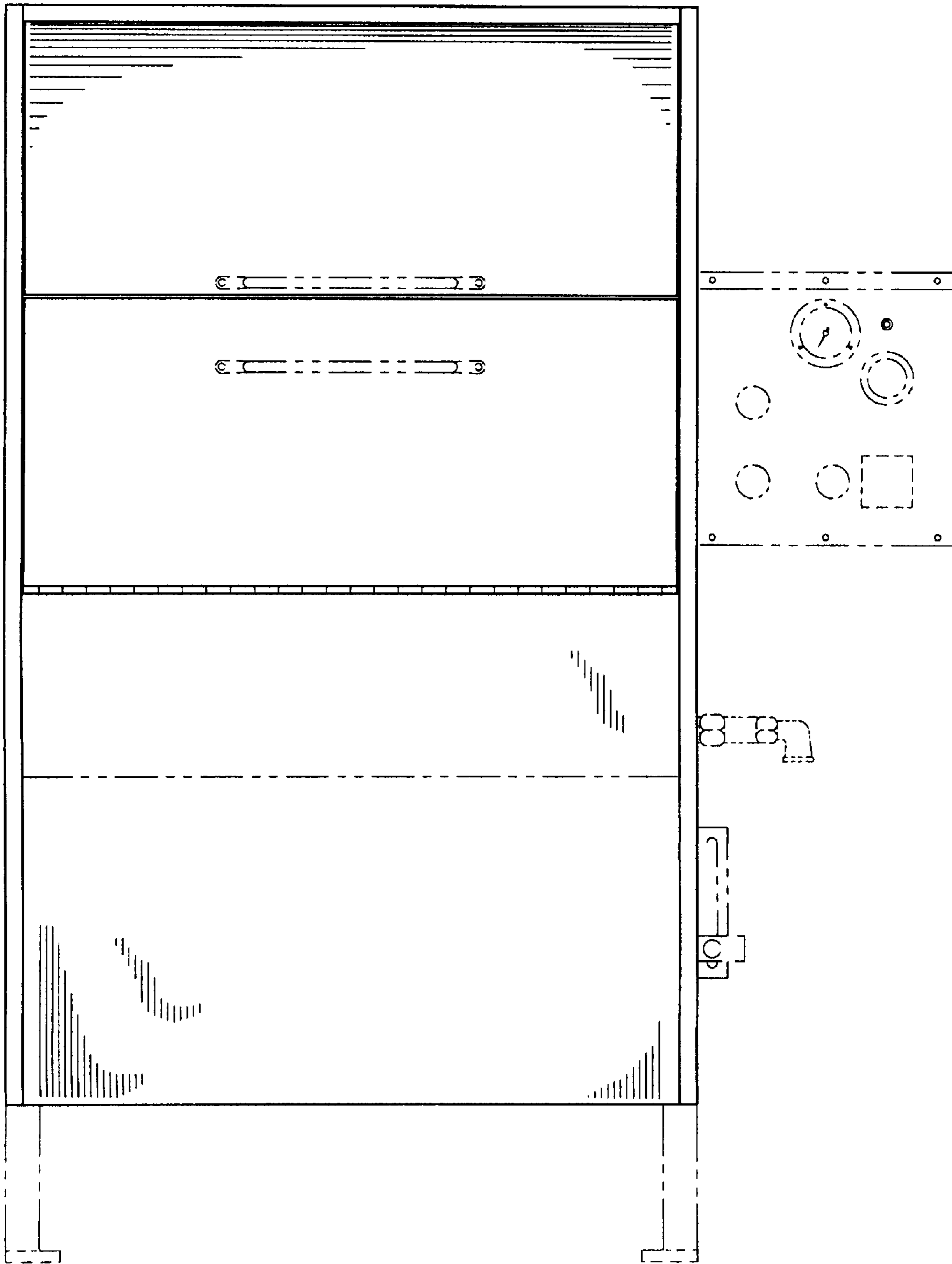

FIG. 9

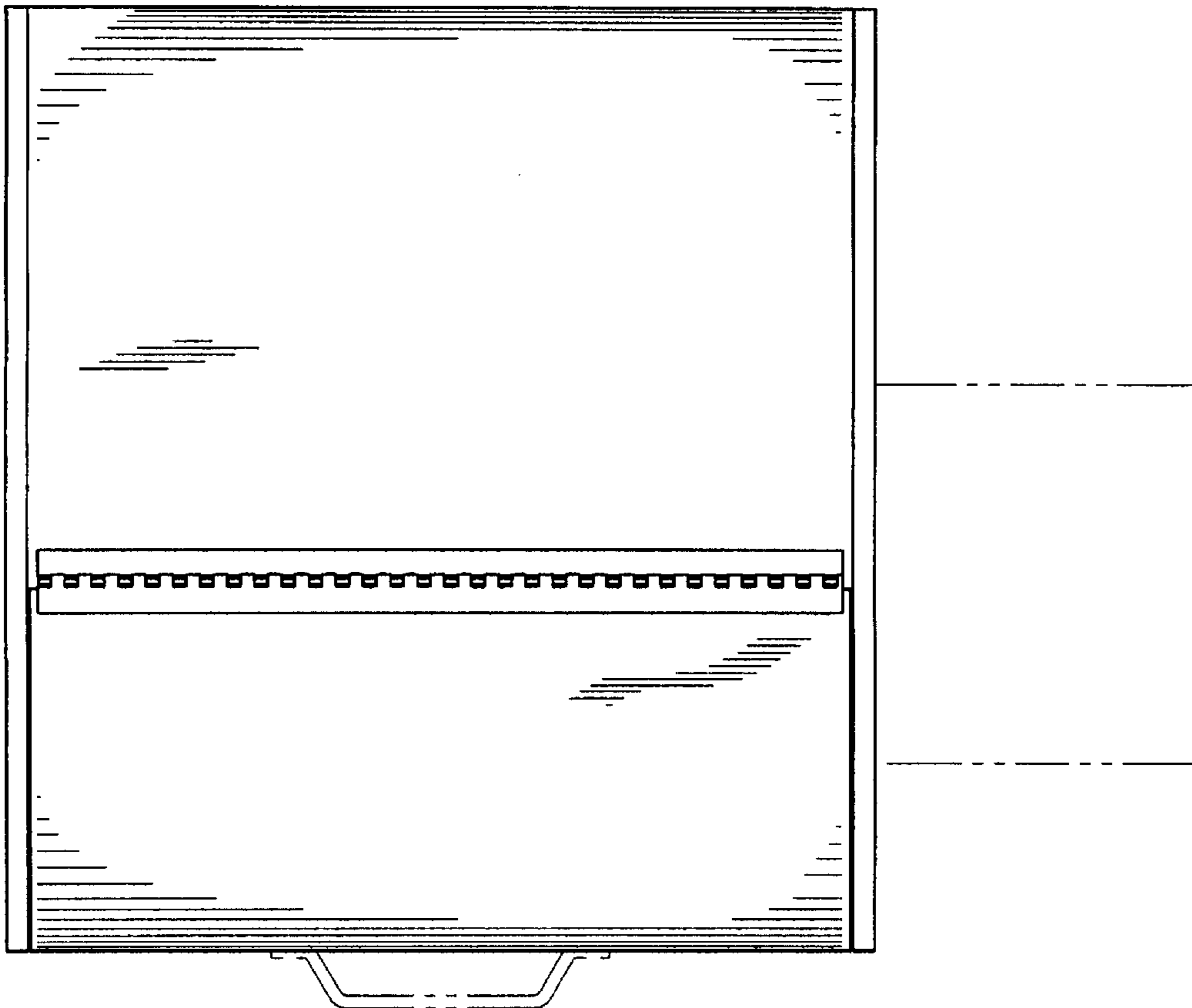

FIG. 10

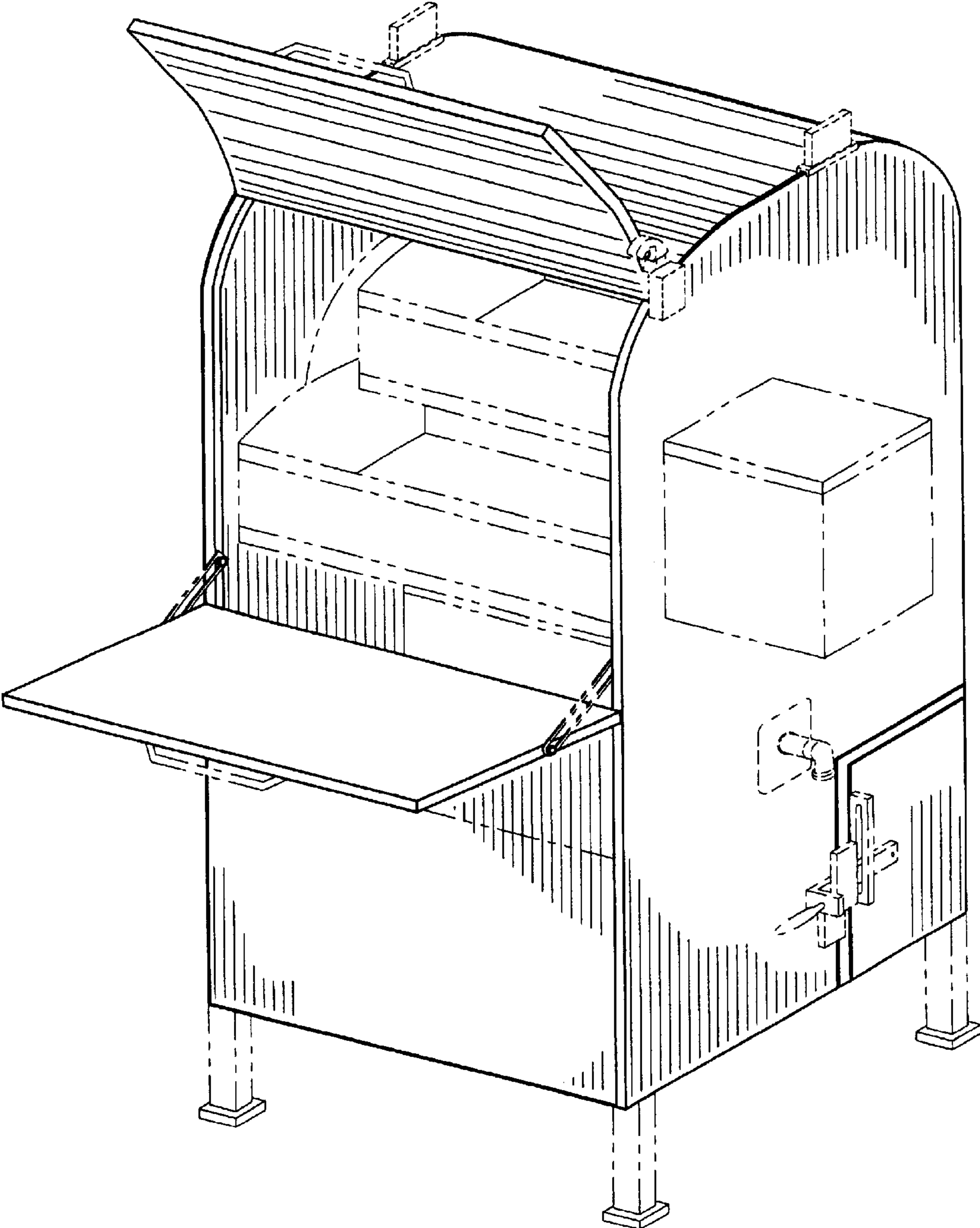

FIG. 11

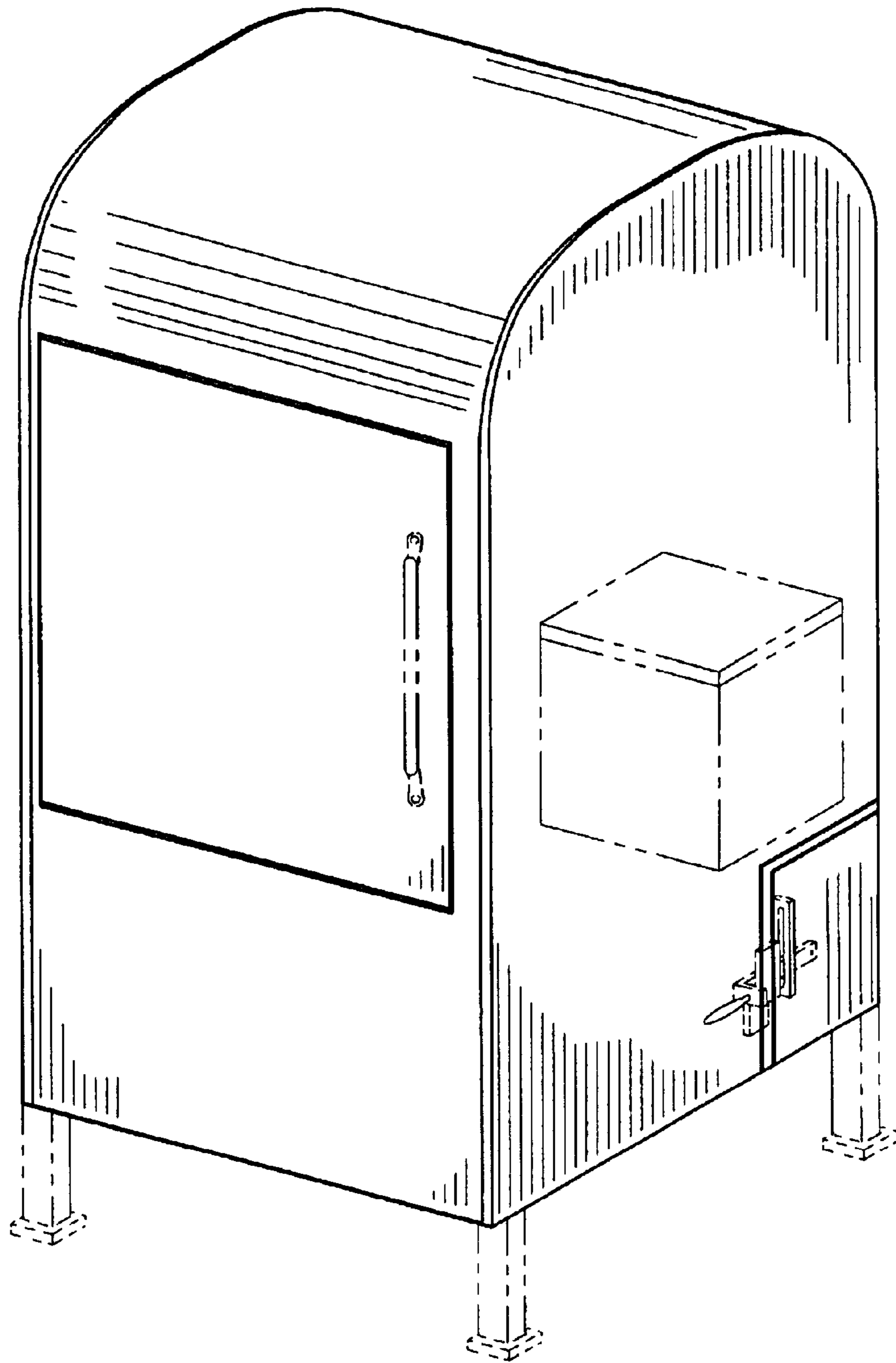

FIG. 12

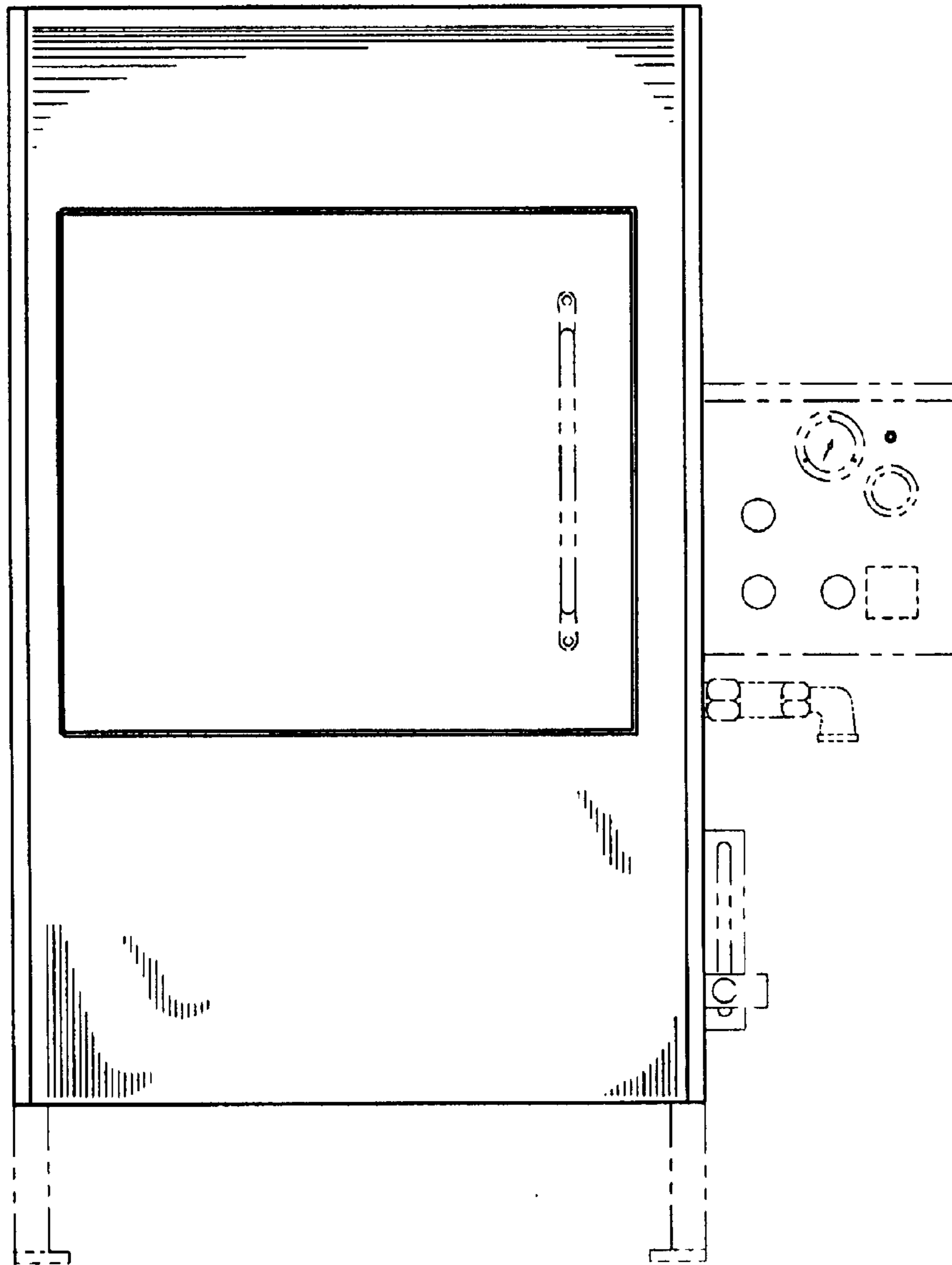

FIG. 13

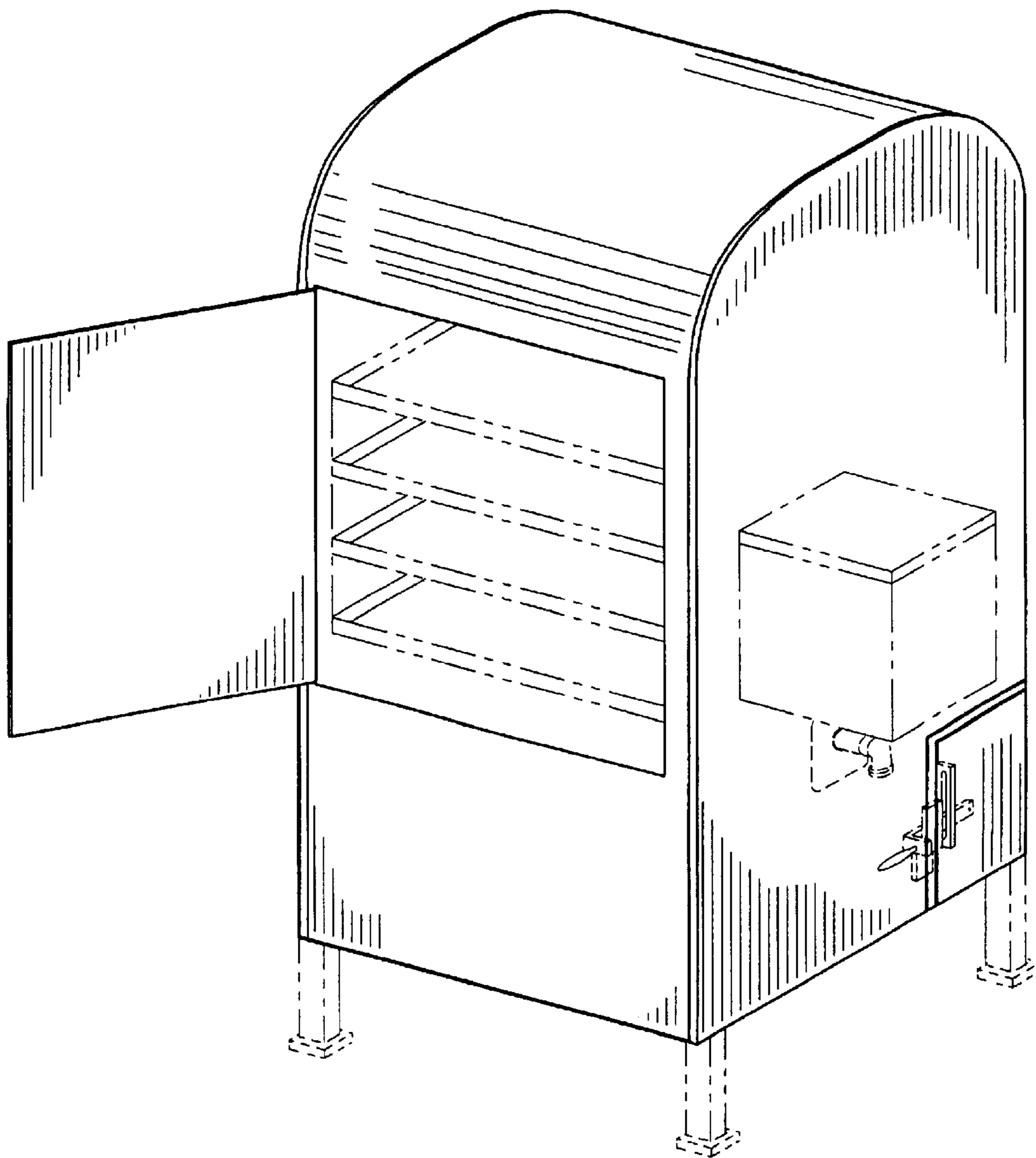



FIG. 14

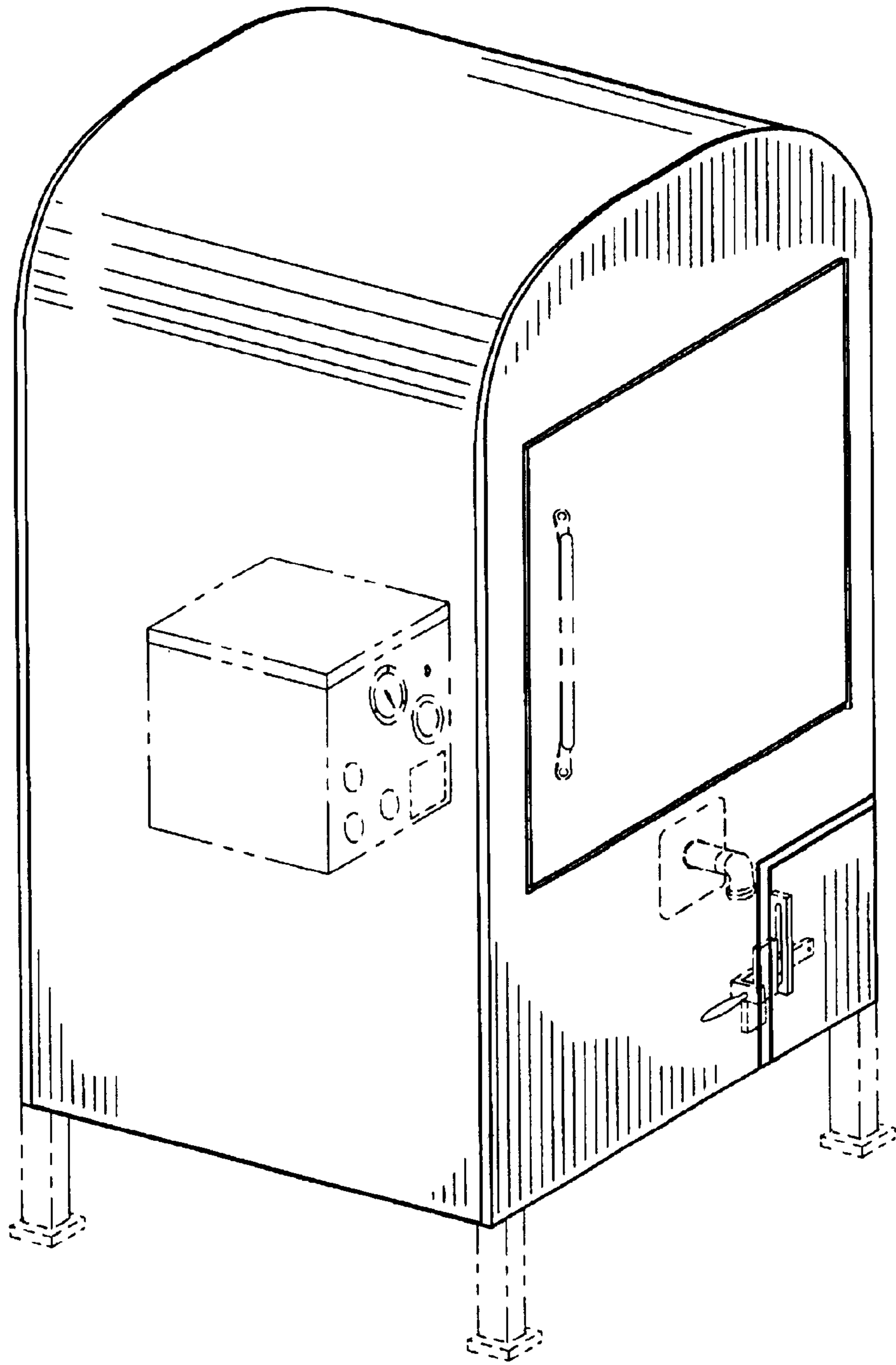

FIG. 15

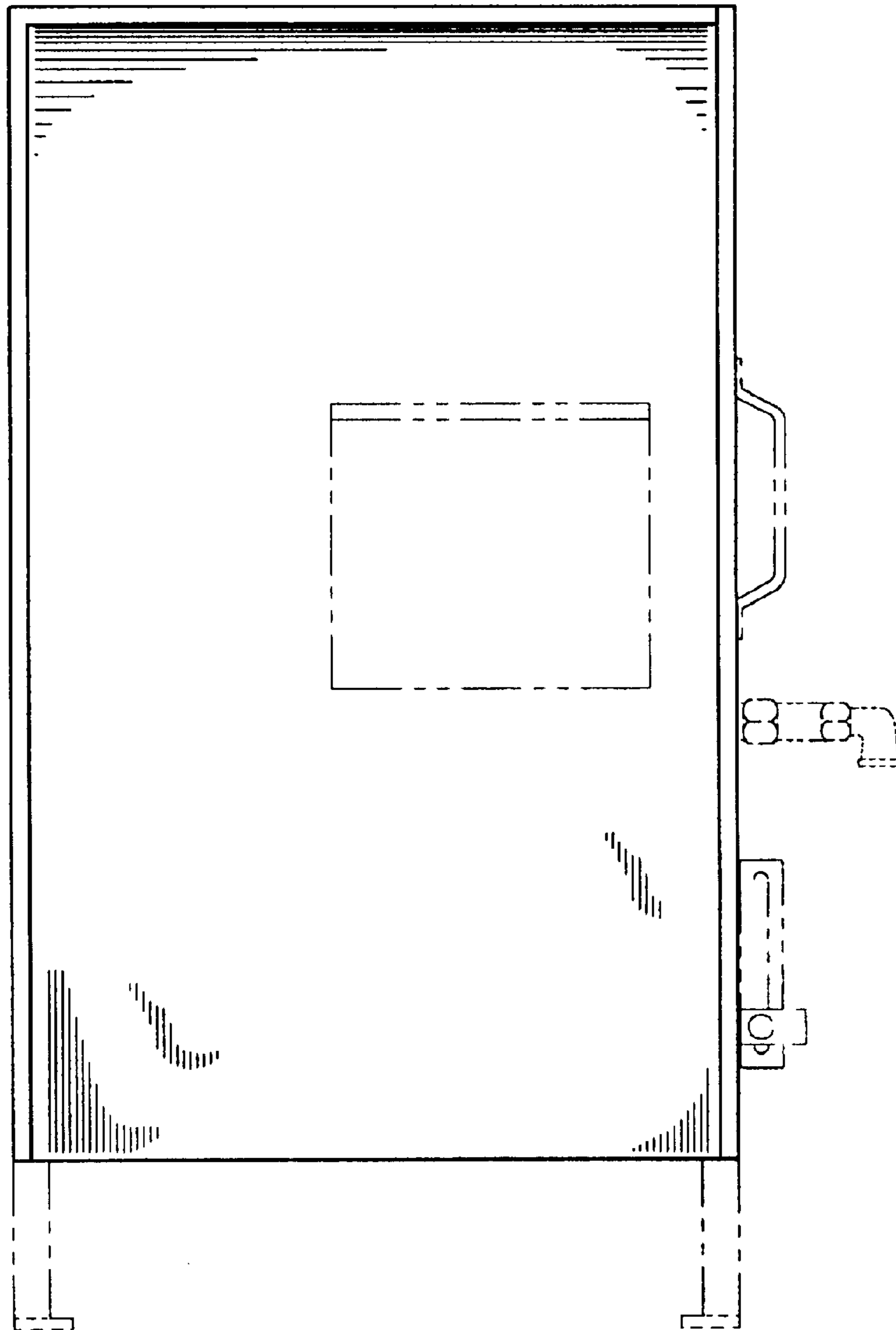

FIG. 16

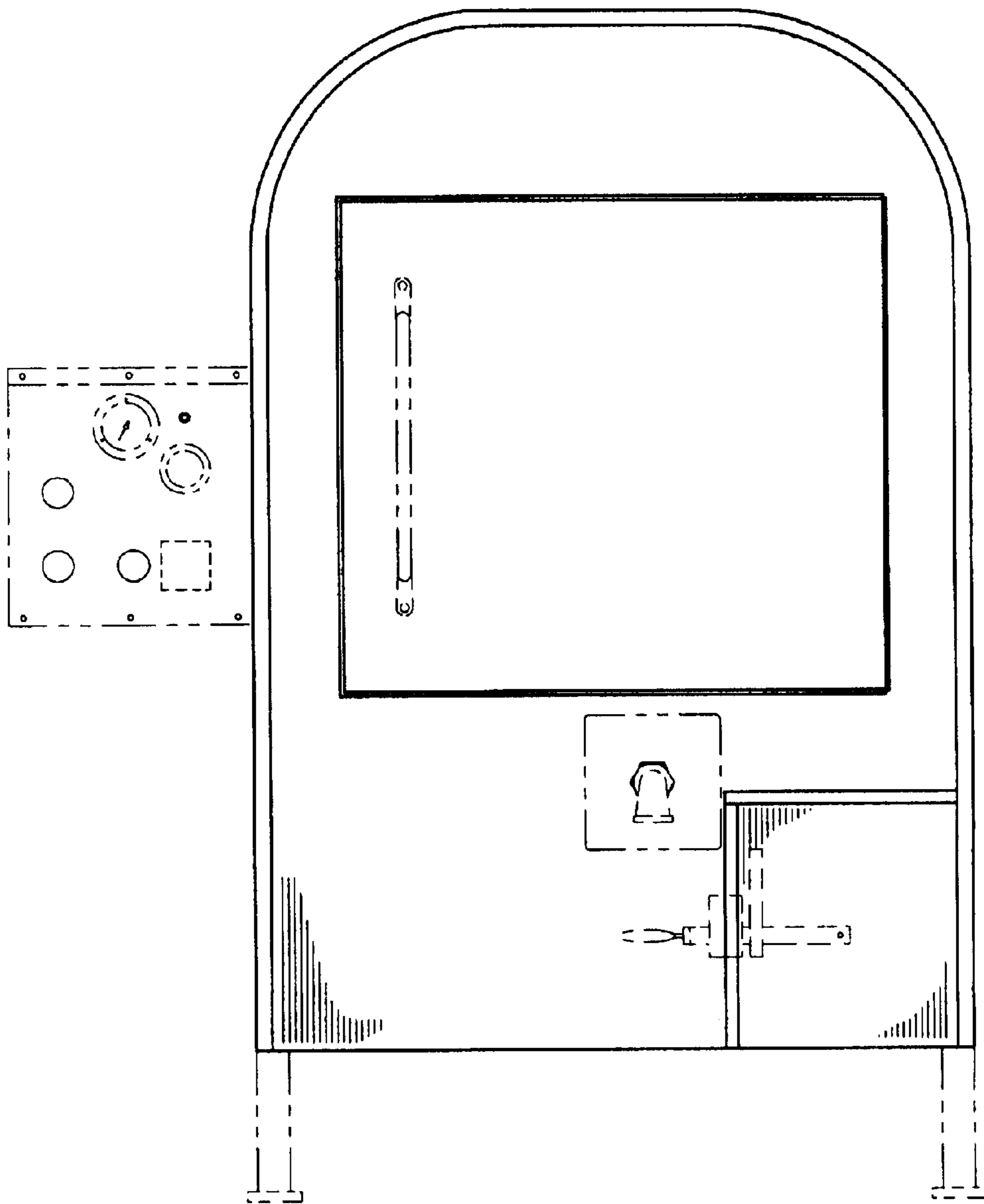

FIG. 17

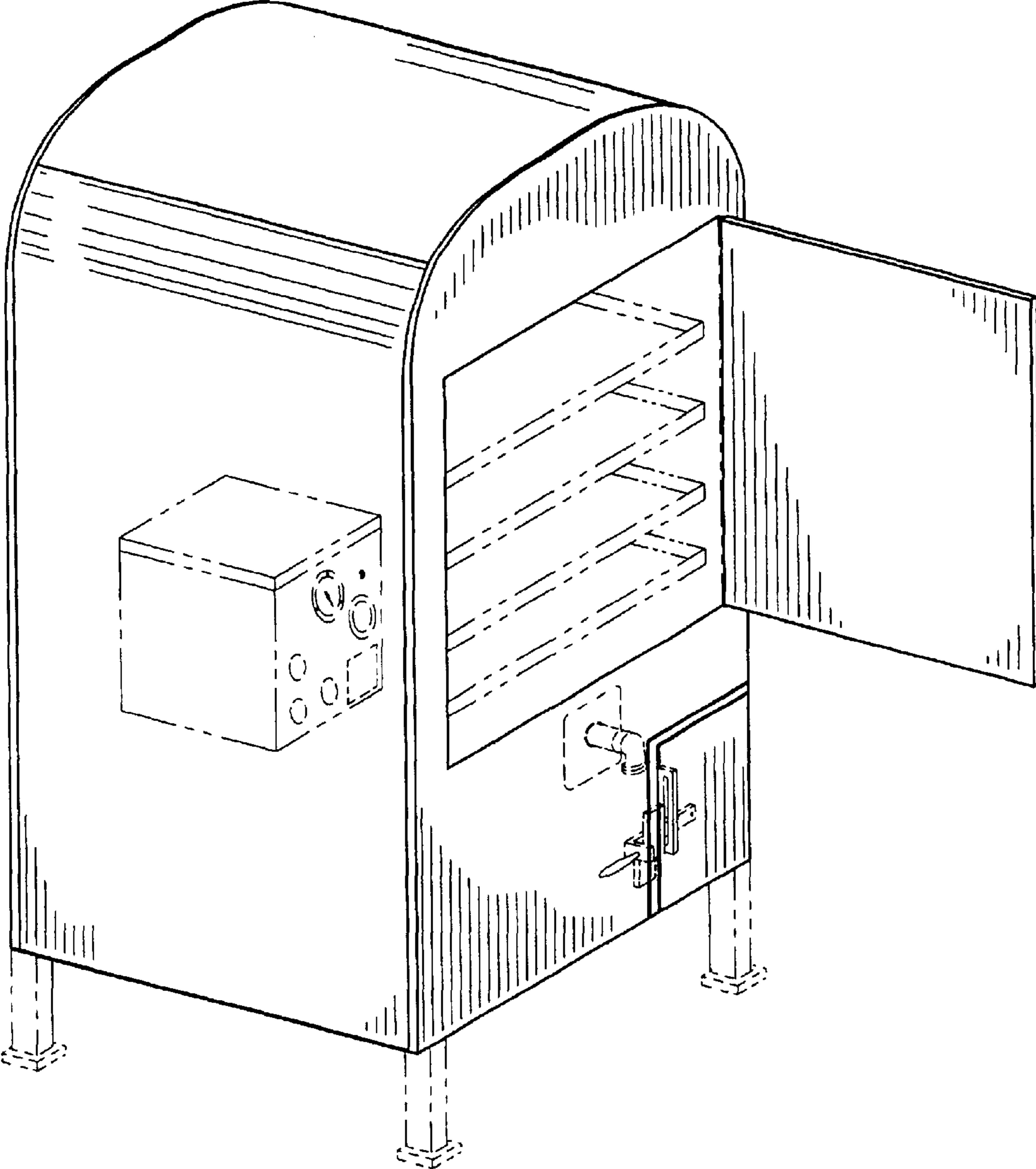

FIG. 18

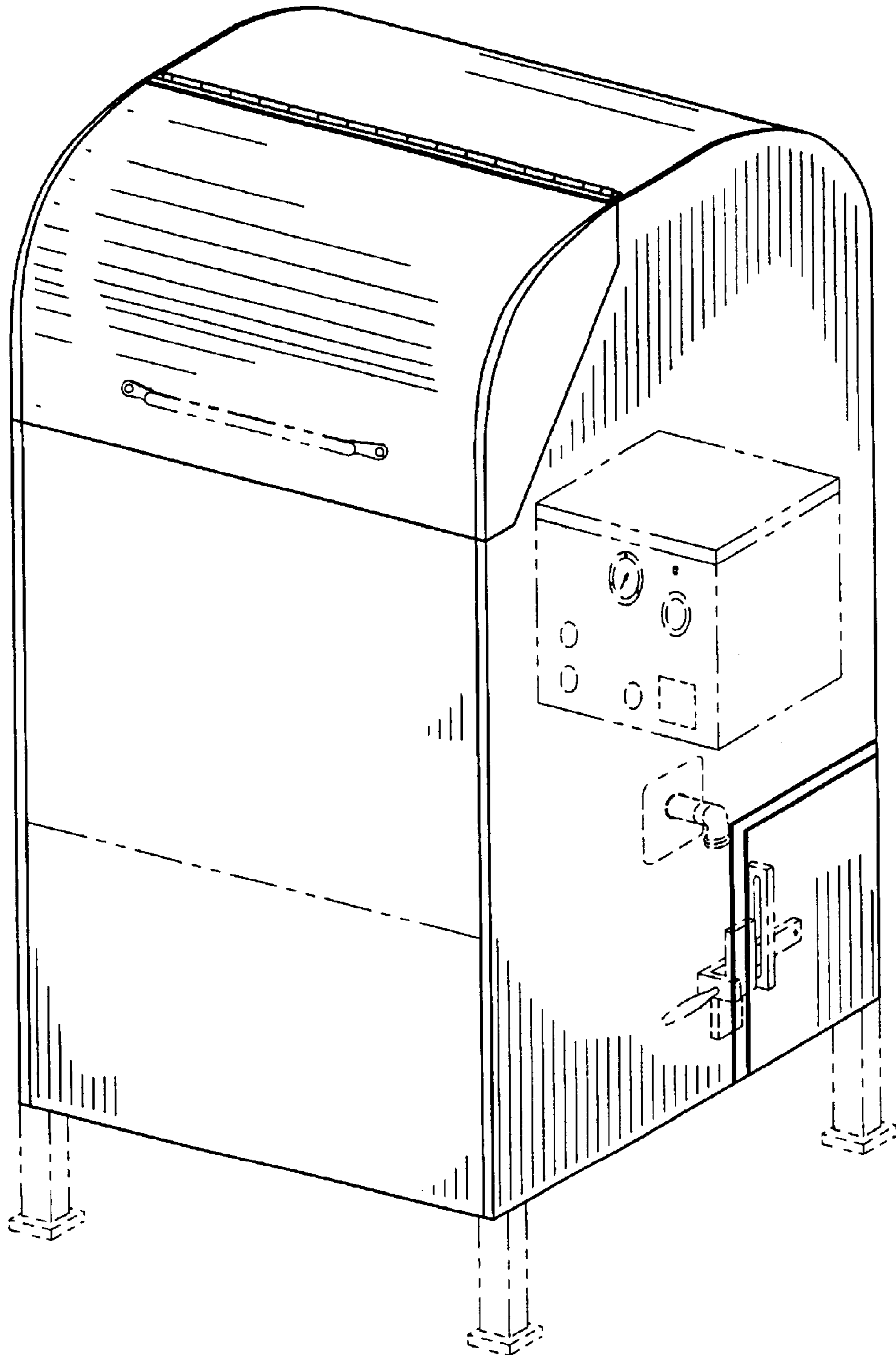

FIG. 19

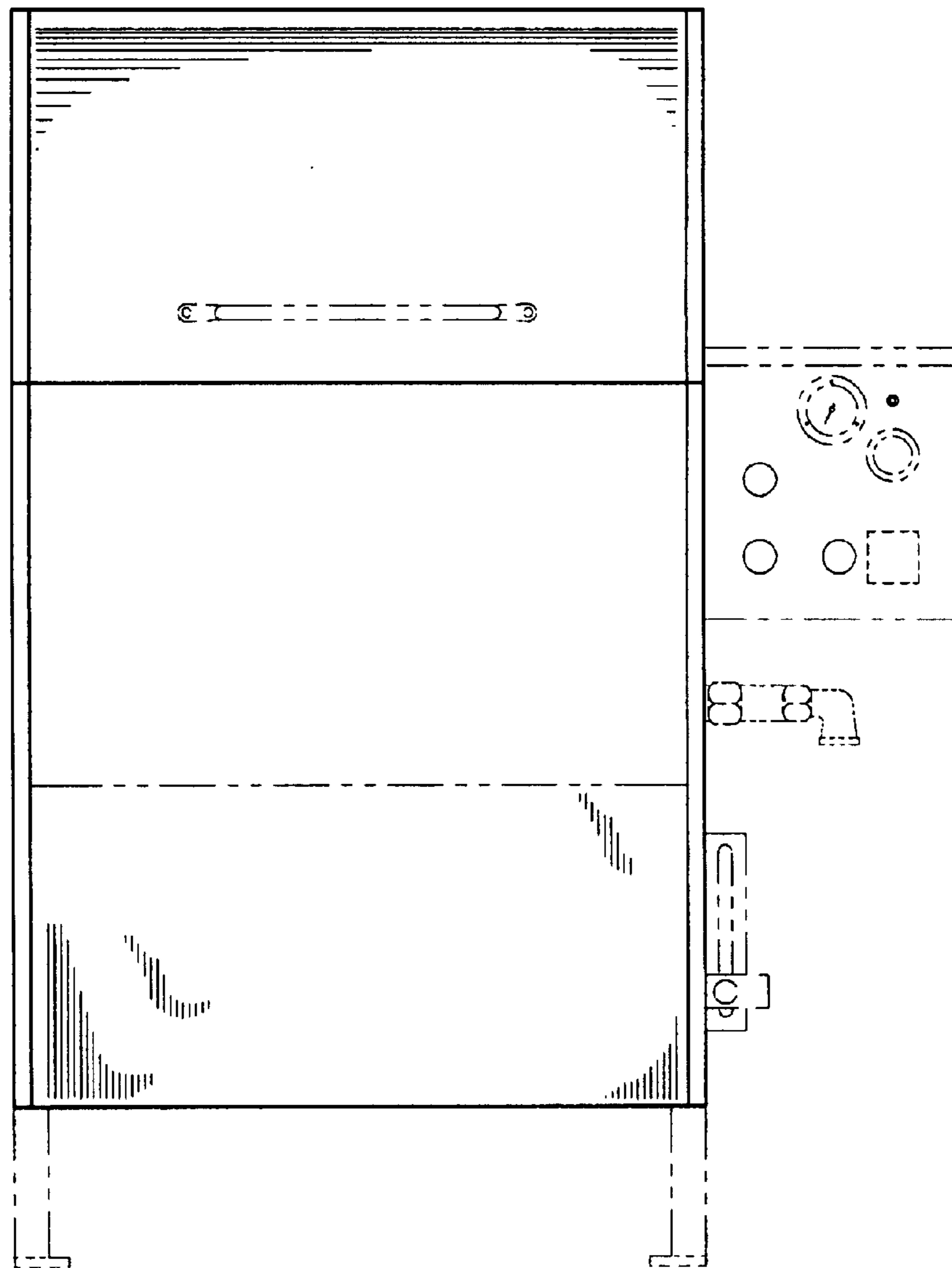

FIG. 20

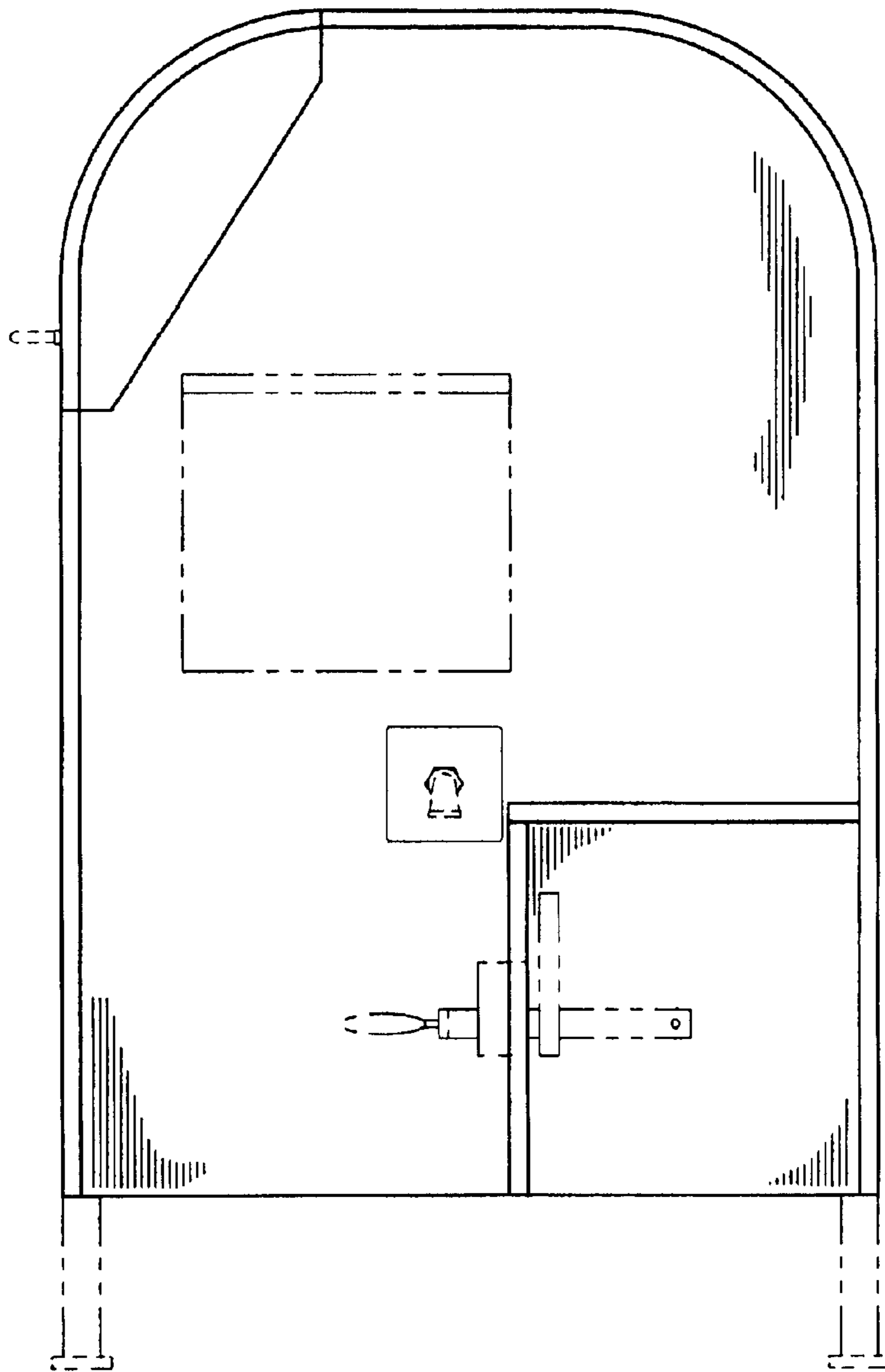



FIG. 21

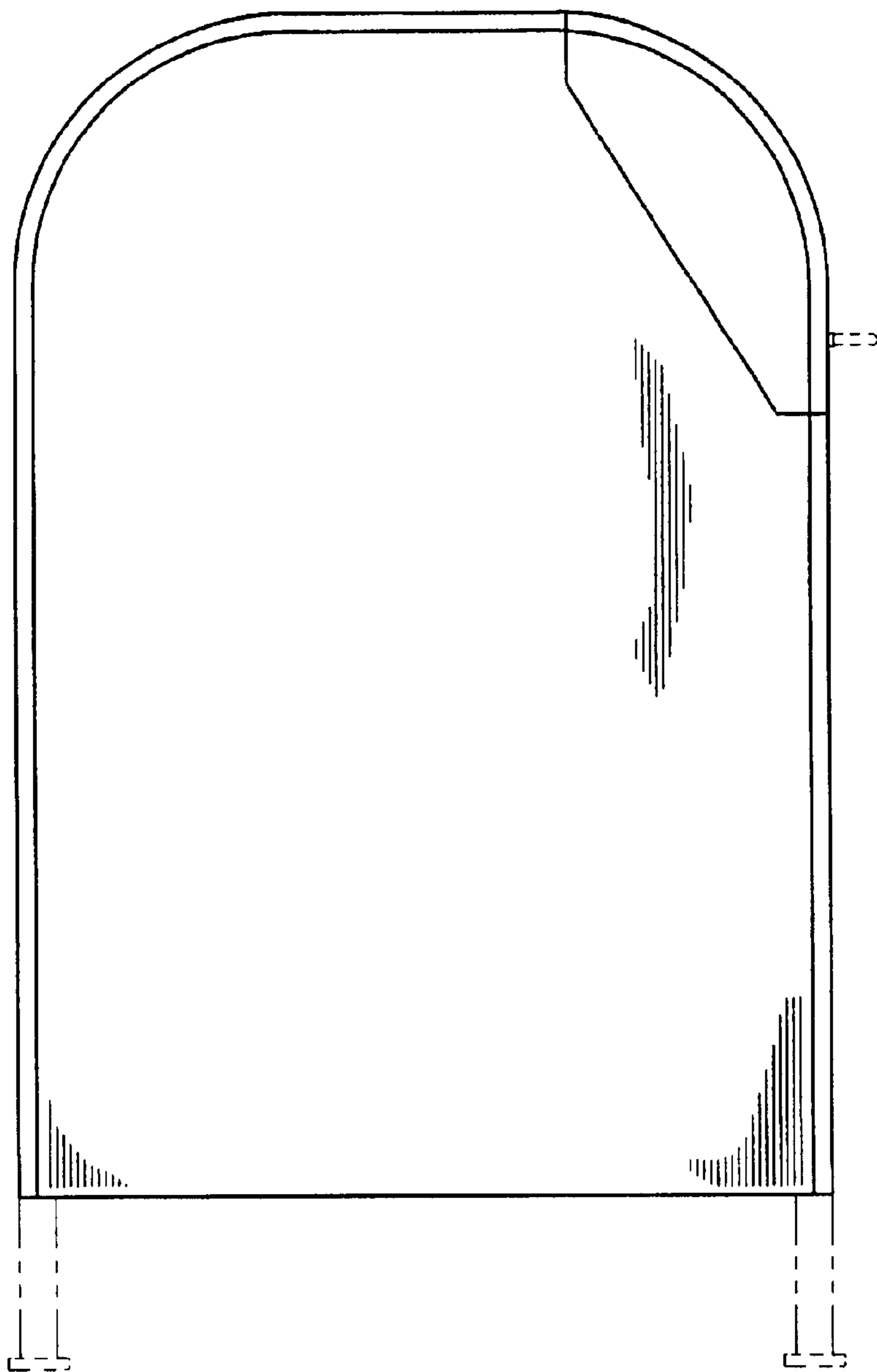

FIG. 22

