



US00D534735S

(12) **United States Design Patent**  
**Maltz**

(10) **Patent No.:** **US D534,735 S**

(45) **Date of Patent:** **\*\* Jan. 9, 2007**

(54) **SEAT**  
(76) **Inventor:** **Dean Maltz**, 330 W. 38<sup>th</sup> St., Suite 811,  
New York, NY (US) 10018

D148,511 S \* 1/1948 Young ..... D6/378  
2,481,725 A \* 9/1949 Culley et al. .... 297/137  
D454,441 S \* 3/2002 Bermudez et al. .... D6/378  
D482,535 S \* 11/2003 Williams et al. .... D6/334

(\*\*) **Term:** **14 Years**

\* cited by examiner

(21) **Appl. No.:** **29/238,048**

*Primary Examiner*—Mimosa De

(22) **Filed:** **Dec. 31, 2003**

(74) *Attorney, Agent, or Firm*—Steven, Davis, Miller &  
Mosher, LLP

(30) **Foreign Application Priority Data**

(57) **CLAIM**

Sep. 11, 2003 (EM) ..... 75387

The ornamental design of a seat, as shown and described.

(51) **LOC (8) Cl.** ..... **06-01**

**DESCRIPTION**

(52) **U.S. Cl.** ..... **D6/375**

(58) **Field of Classification Search** ..... D6/334,  
D6/335, 336, 374, 375, 376, 377, 378, 381,  
D6/500–502, 482, 483; 297/232, 423.19,  
297/445.1, 446.1, 137

FIG. 1 is a front view of a seat of the present invention.  
FIG. 2 is a right side view thereof.  
FIG. 3 is a left side view thereof.  
FIG. 4 is a back view thereof.  
FIG. 5 is a top view thereof.  
FIG. 6 is a bottom view thereof.  
FIG. 7 is a front-corner view thereof.  
FIG. 8 is a back-corner view thereof; and,  
FIG. 9 is a perspective view thereof.

See application file for complete search history.

(56) **References Cited**

**U.S. PATENT DOCUMENTS**

D146,981 S \* 6/1947 Noll ..... D6/378

**1 Claim, 3 Drawing Sheets**

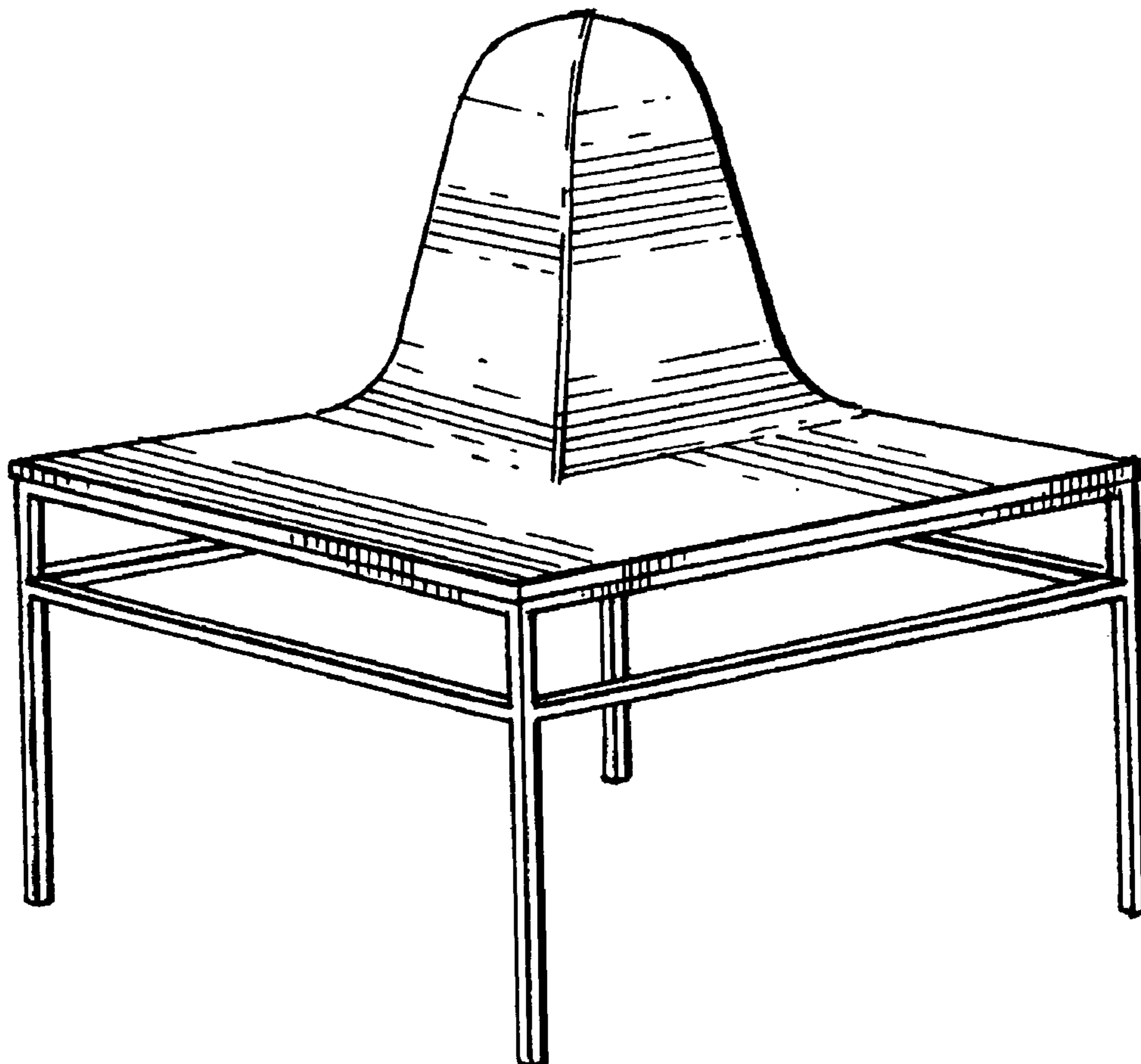

FIG. 1

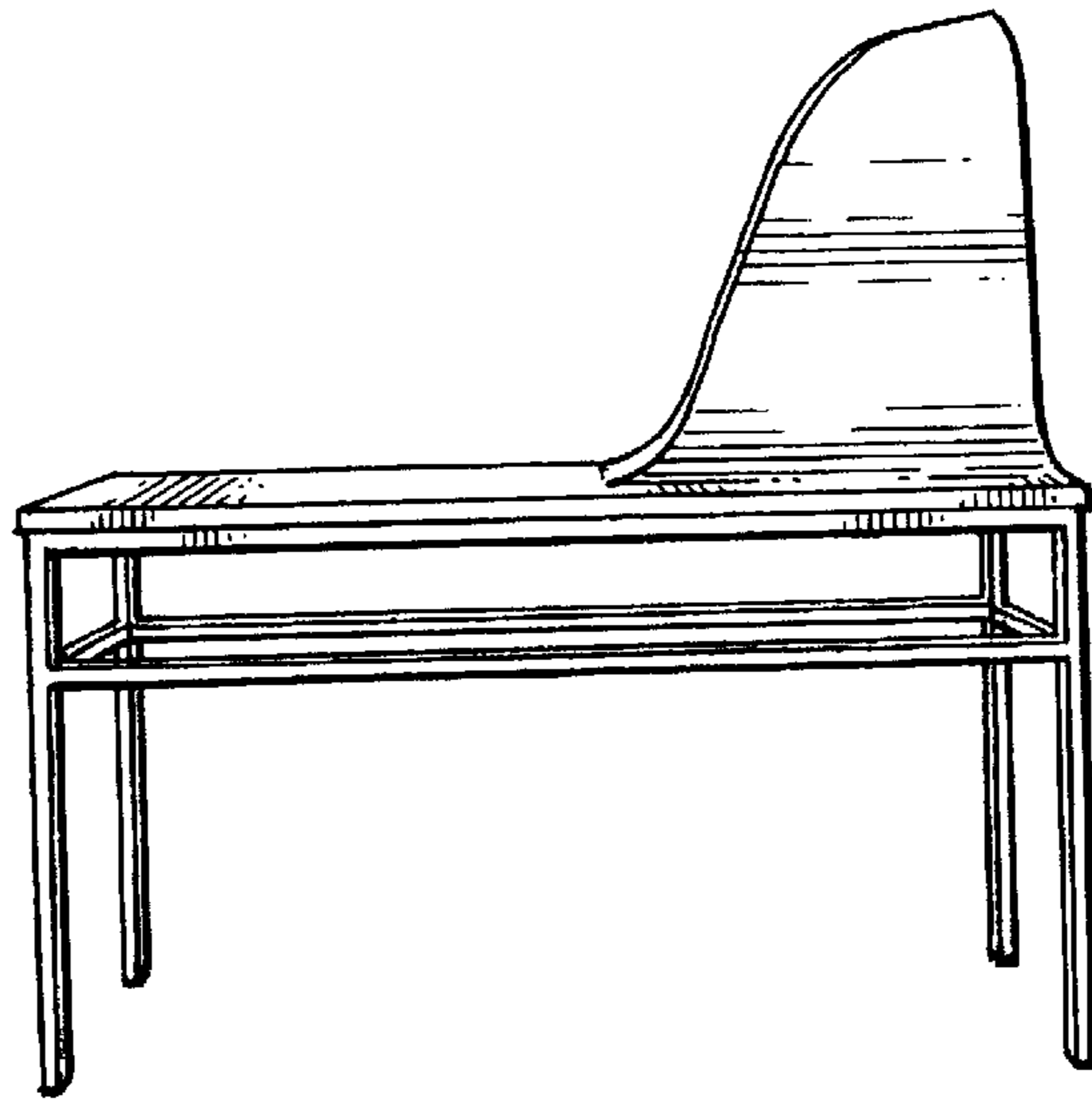

FIG. 2

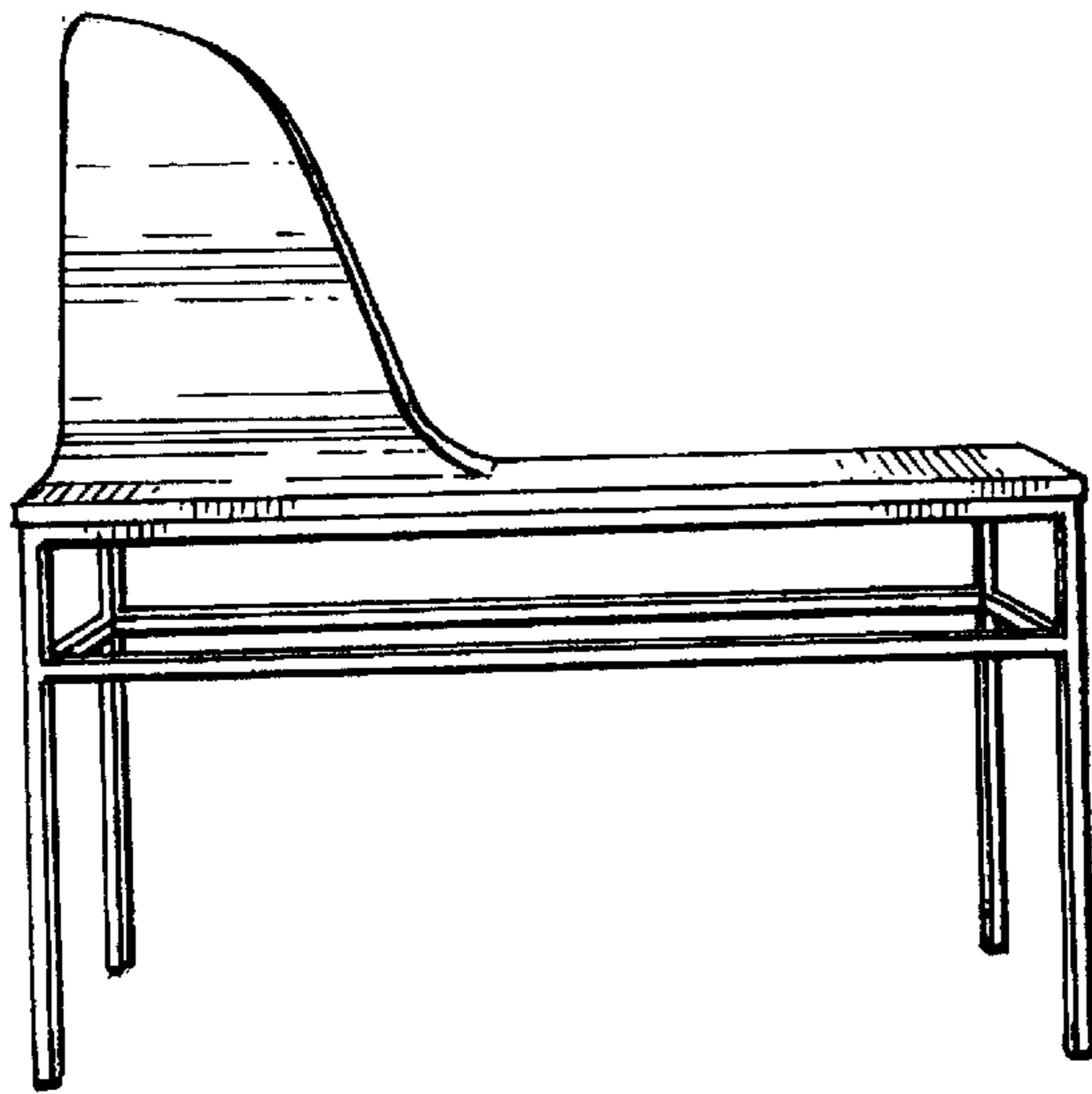

FIG. 3

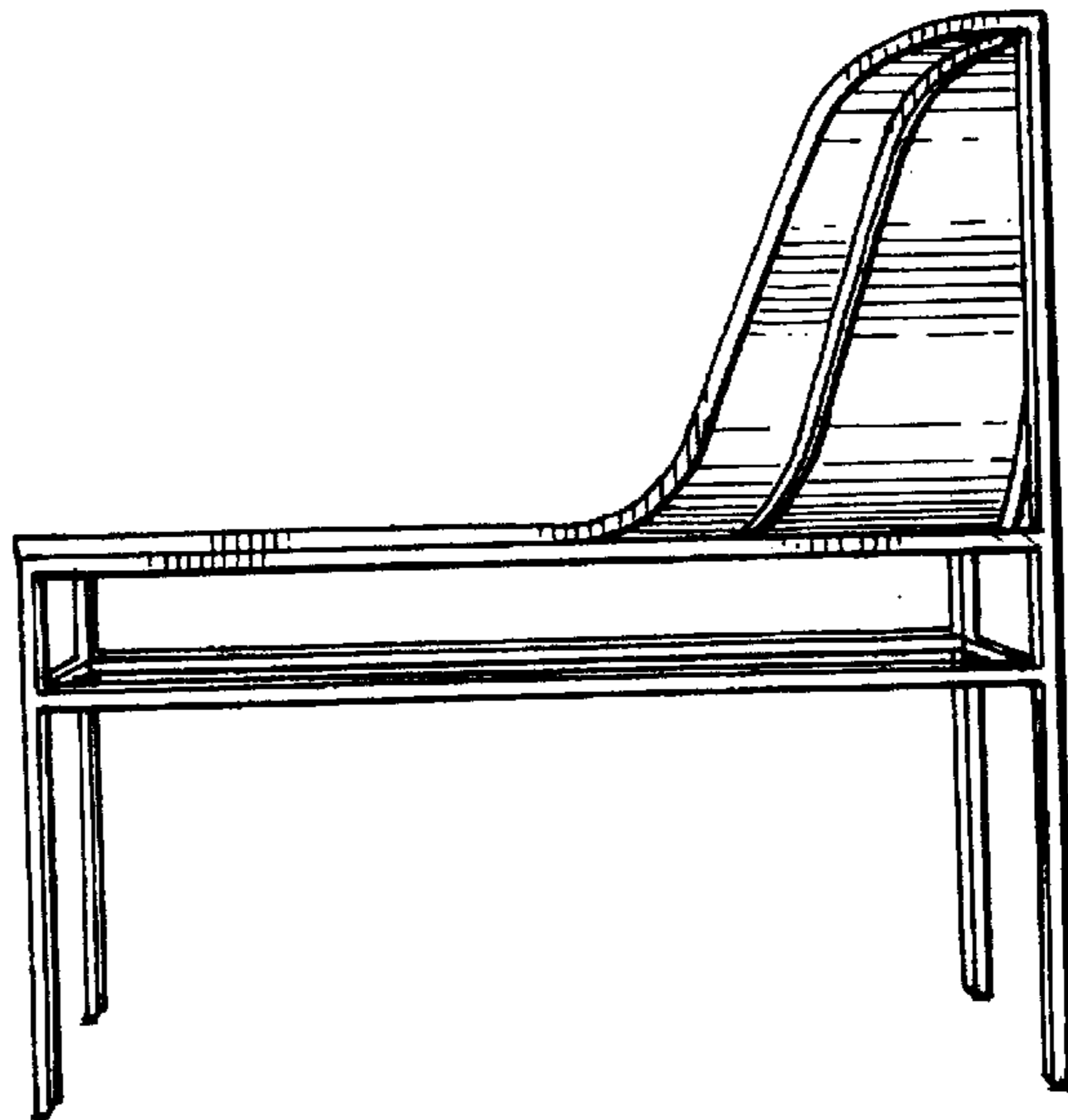

FIG. 4

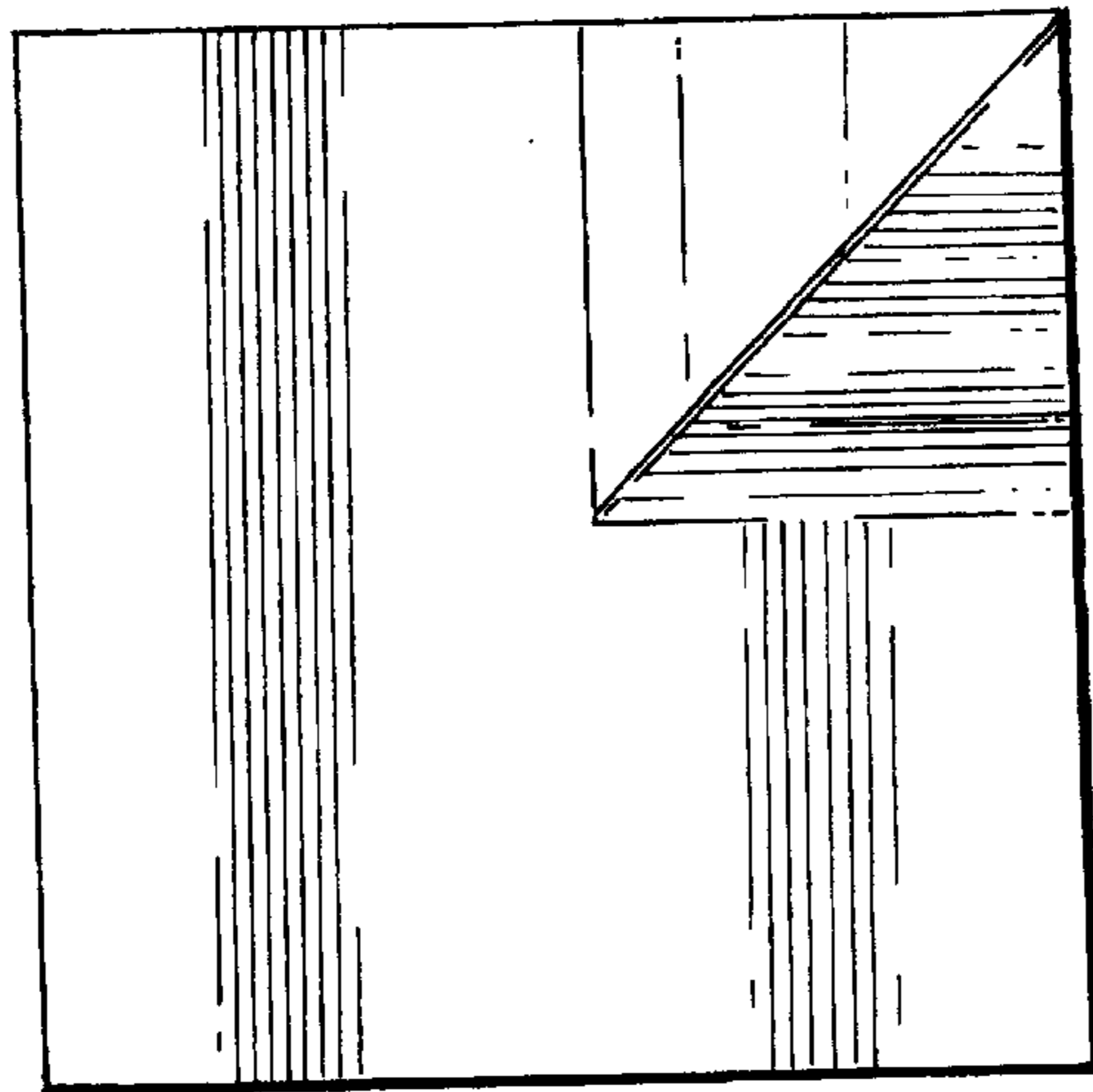
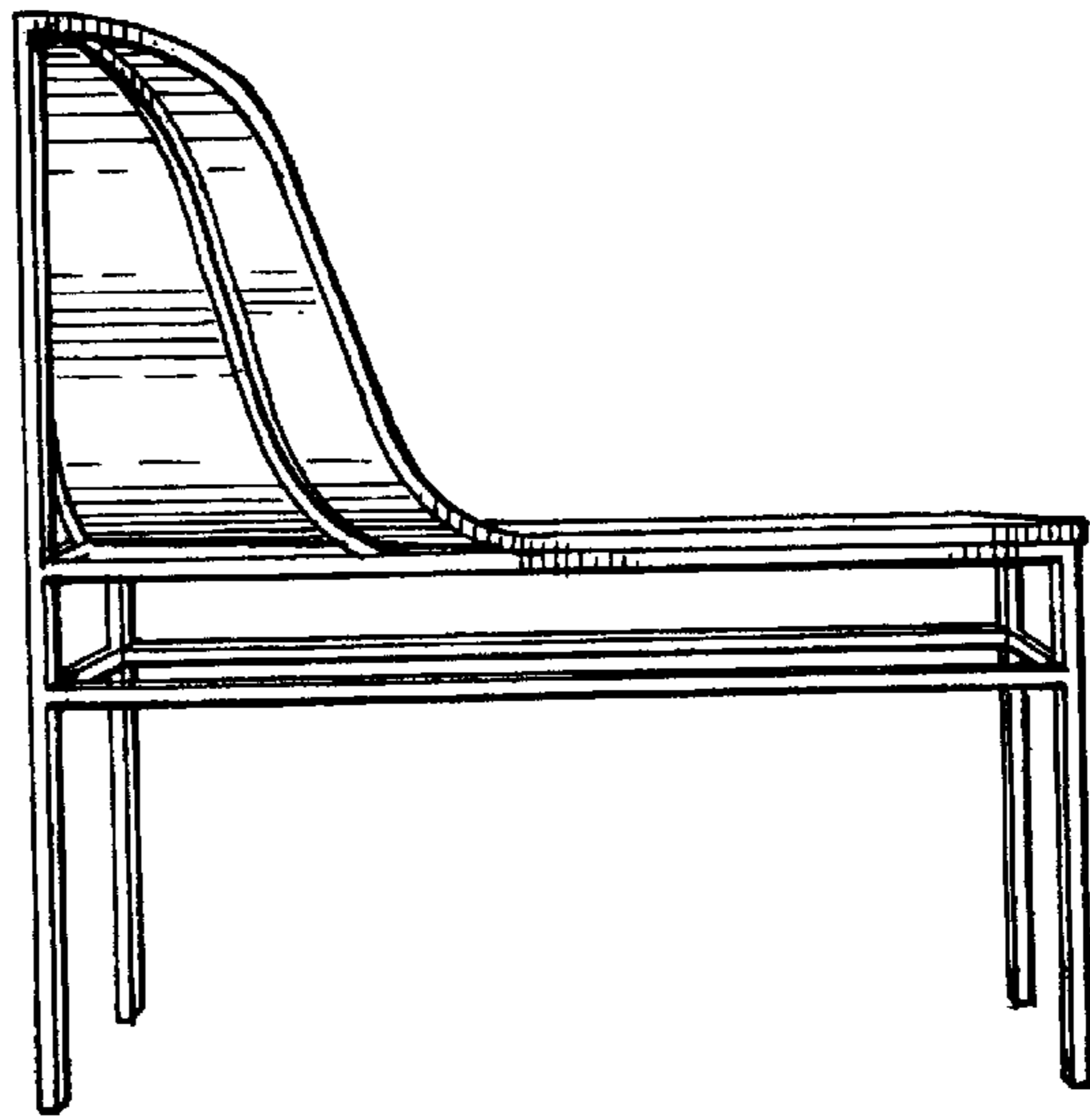

FIG. 5

FIG. 6

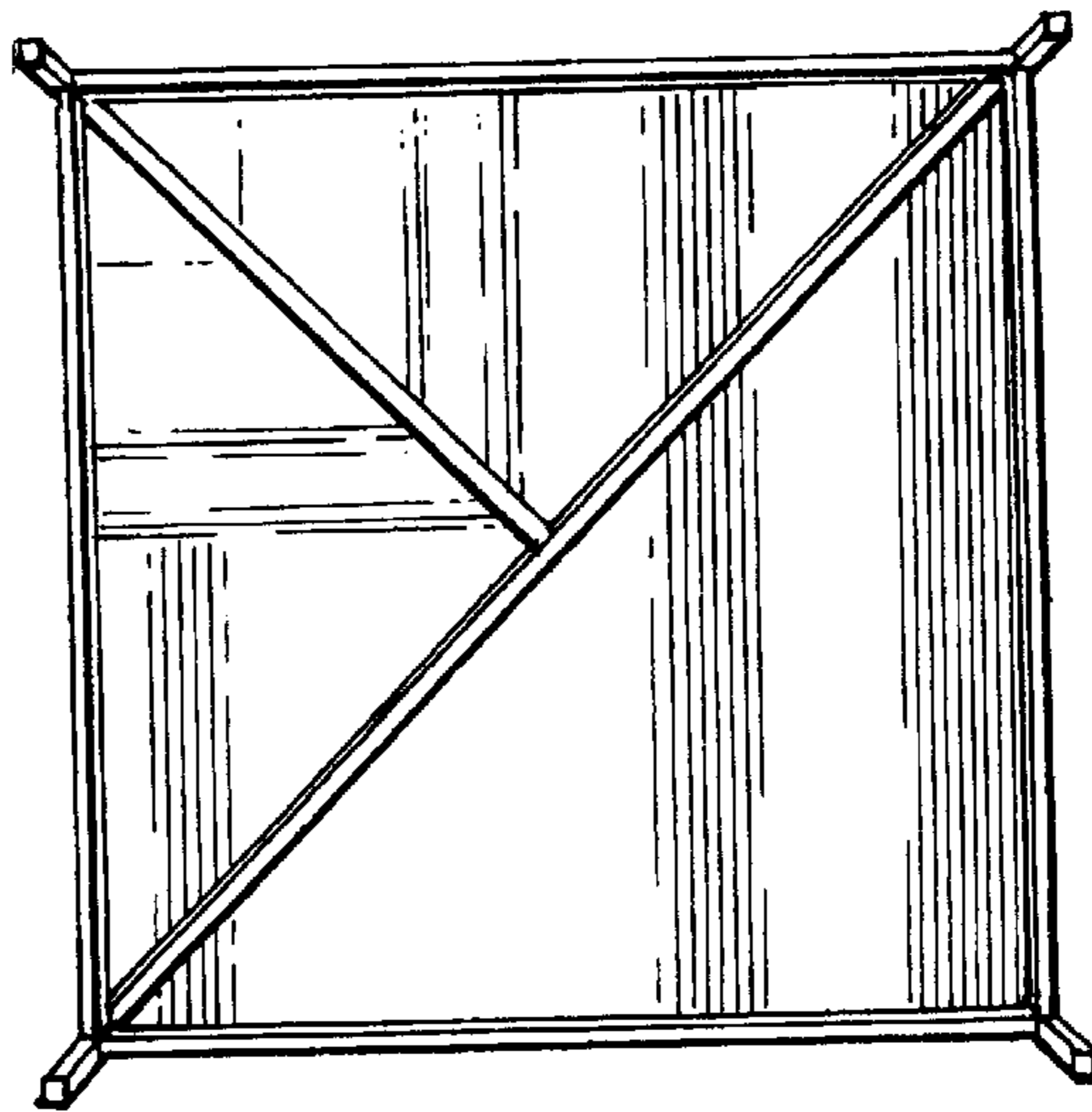

FIG. 7

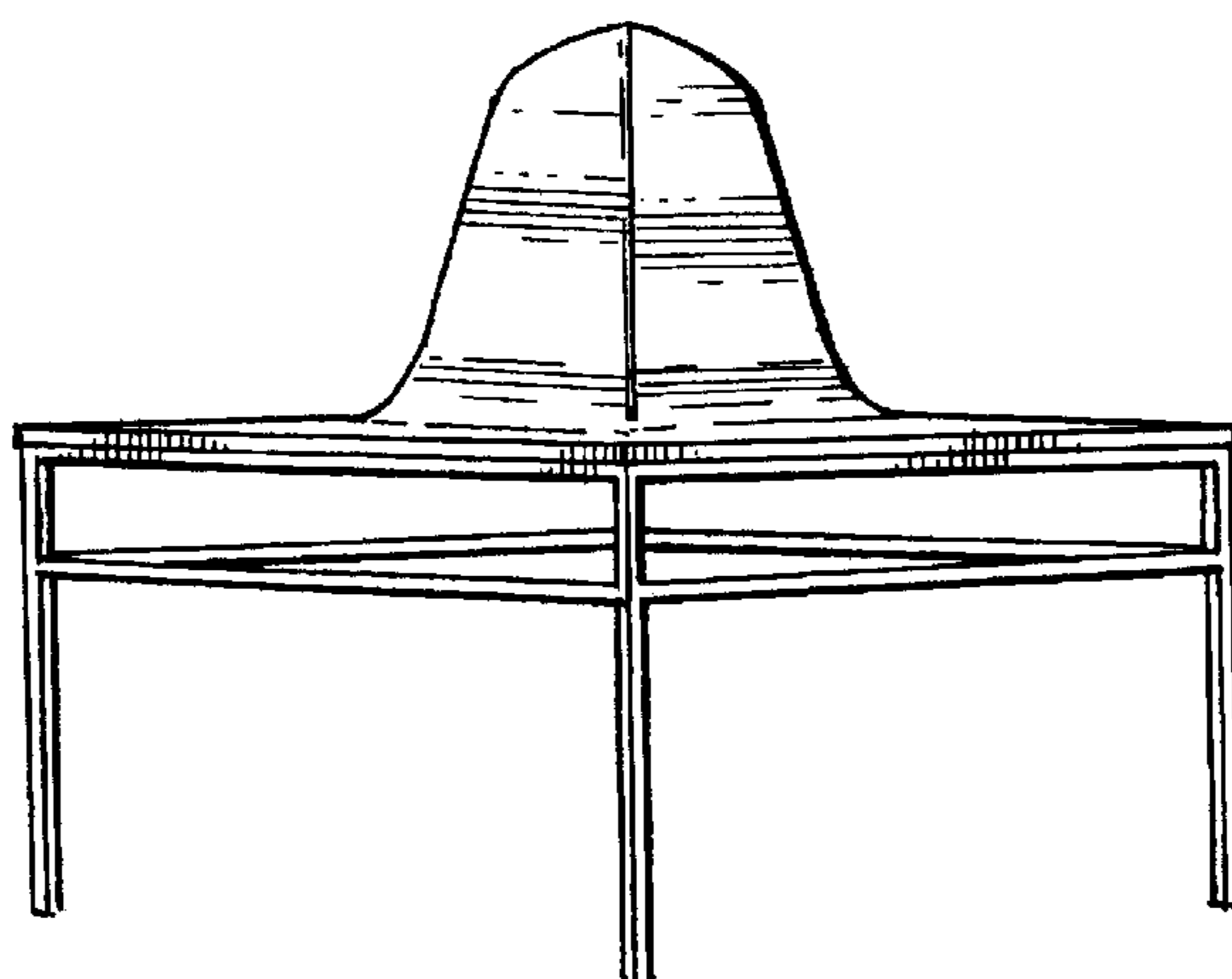

FIG. 8

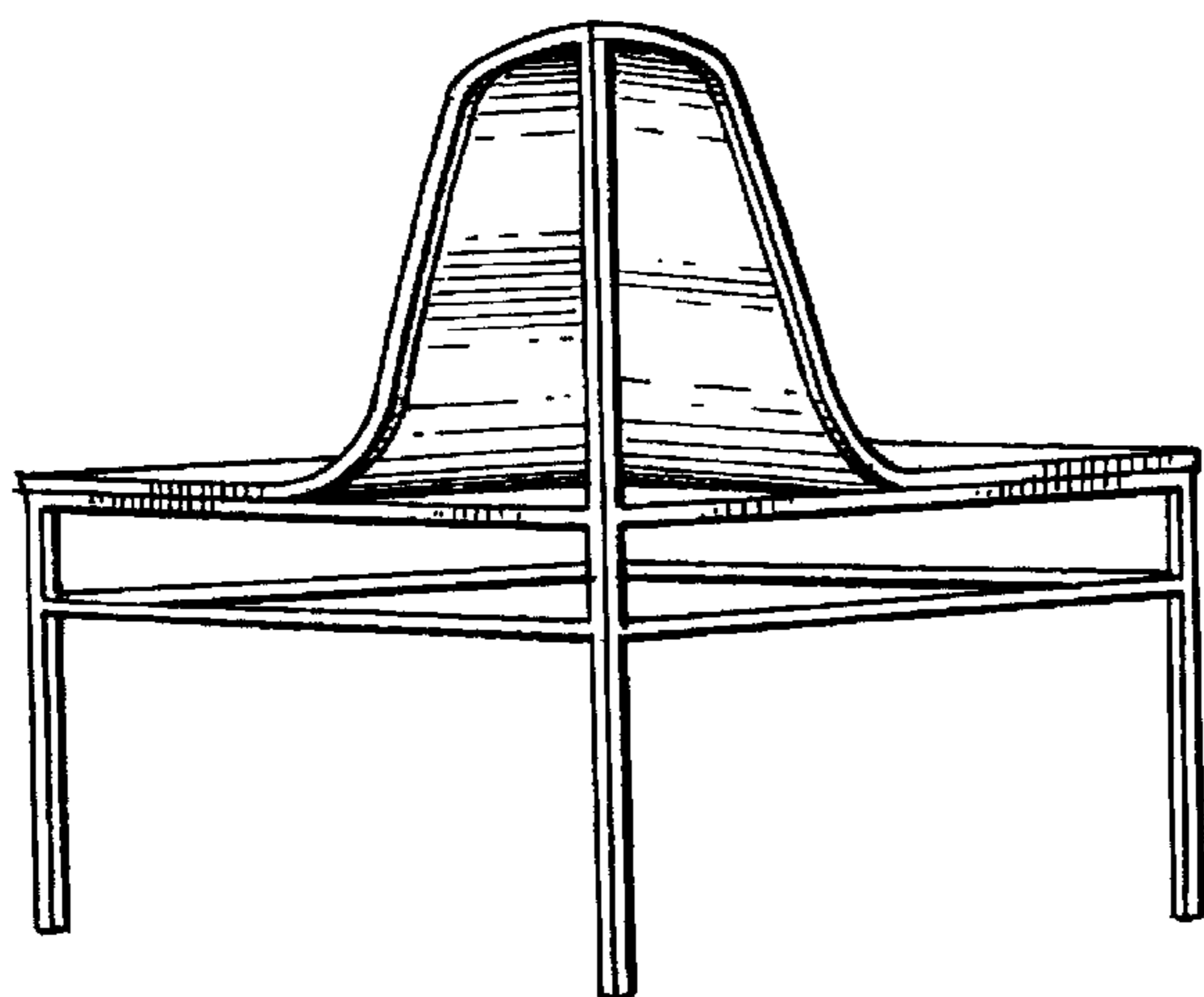

FIG. 9

