

US00D534646S

(12) **United States Design Patent**
Chang et al.

(10) **Patent No.:** **US D534,646 S**
(45) **Date of Patent:** **** Jan. 2, 2007**

(54) **NUTRITIONAL SUPPLEMENT TABLET**
(75) Inventors: **David S. Chang**, Fullerton, CA (US);
Russell K. Randolph, Anaheim, CA
(US); **Mary A. Murray**, Irvine, CA
(US)

(73) Assignee: **Access Business Group International
LLC**, Ada, MI (US)

(**) Term: **14 Years**

(21) Appl. No.: **29/251,330**

(22) Filed: **Jan. 6, 2006**

(51) **LOC (8) Cl.** **28-01**

(52) **U.S. Cl.** **D24/101**

(58) **Field of Classification Search** D24/100-104;
D28/4, 8.1, 8.2; D1/100, 121, 125-128; 424/464-482;
D9/663

See application file for complete search history.

(56) **References Cited**

U.S. PATENT DOCUMENTS

D88,622 S * 12/1932 Bordman D9/663
D98,665 S * 2/1936 Elmer D9/663
4,713,248 A * 12/1987 Kjornaes et al. 424/468

D297,575 S * 9/1988 Yates D24/103
D304,626 S * 11/1989 Contractor et al. D28/8.1
D359,554 S * 6/1995 Dansereau et al. D24/101
D383,535 S * 9/1997 Bryan et al. D24/103
D403,396 S * 12/1998 Lundbom et al. D24/101
D423,141 S * 4/2000 Binstock et al. D28/8.1
D485,963 S * 2/2004 Norton D1/127
D500,849 S * 1/2005 Rinker et al. D24/101

* cited by examiner

Primary Examiner—Charles A. Rademaker

(74) *Attorney, Agent, or Firm*—Alticor Inc.

(57) **CLAIM**

The ornamental design for a nutritional supplement tablet, as shown and described.

DESCRIPTION

FIG. 1 is a top perspective view of a nutritional supplement tablet showing our new design;
FIG. 2 is a top plan view thereof;
FIG. 3 is a bottom plan view thereof;
FIG. 4 is a left side elevational view thereof;
FIG. 5 is a right side elevational view thereof;
FIG. 6 is a rear elevational view thereof; and,
FIG. 7 is a front elevational view thereof.

1 Claim, 6 Drawing Sheets

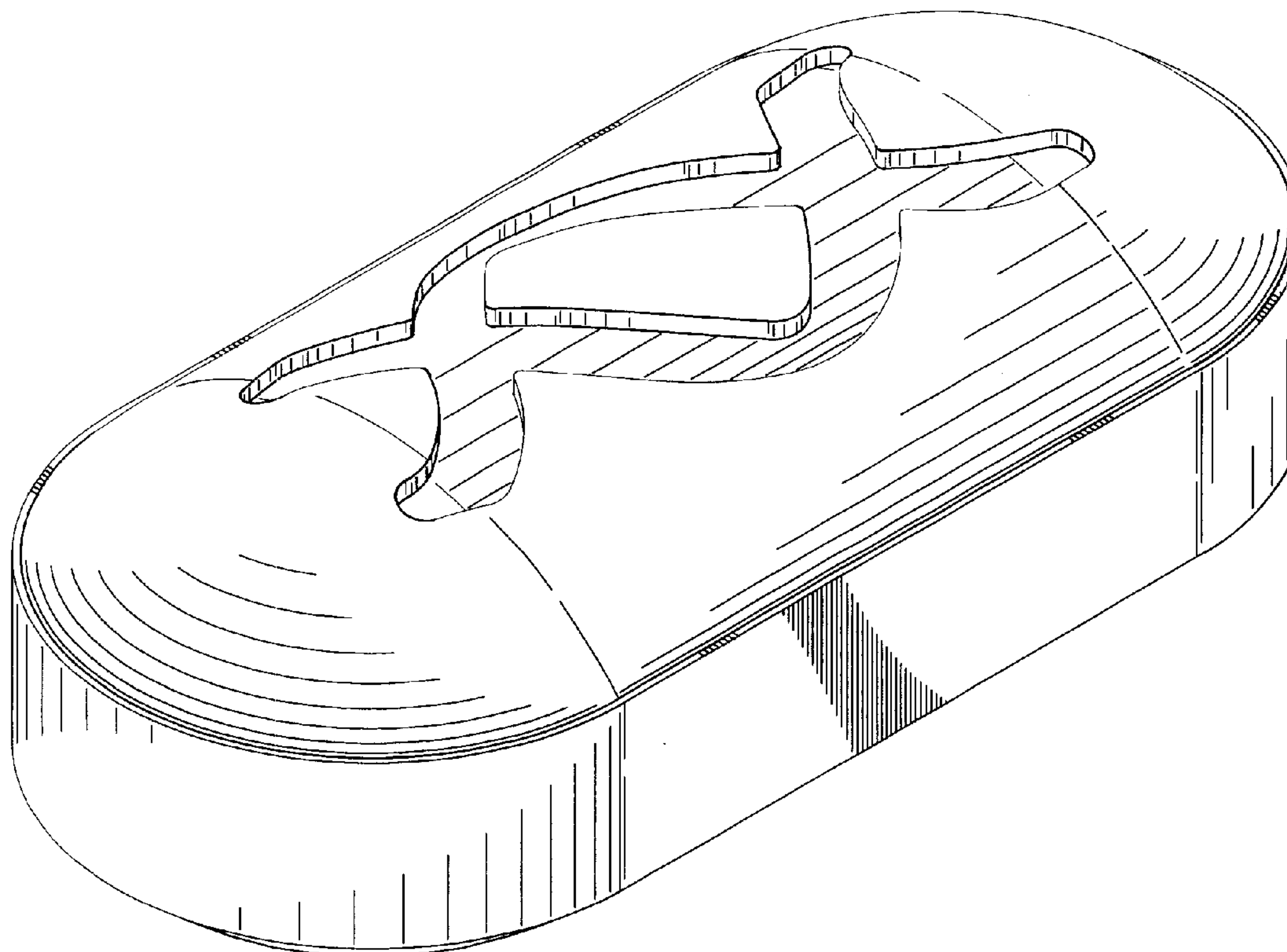

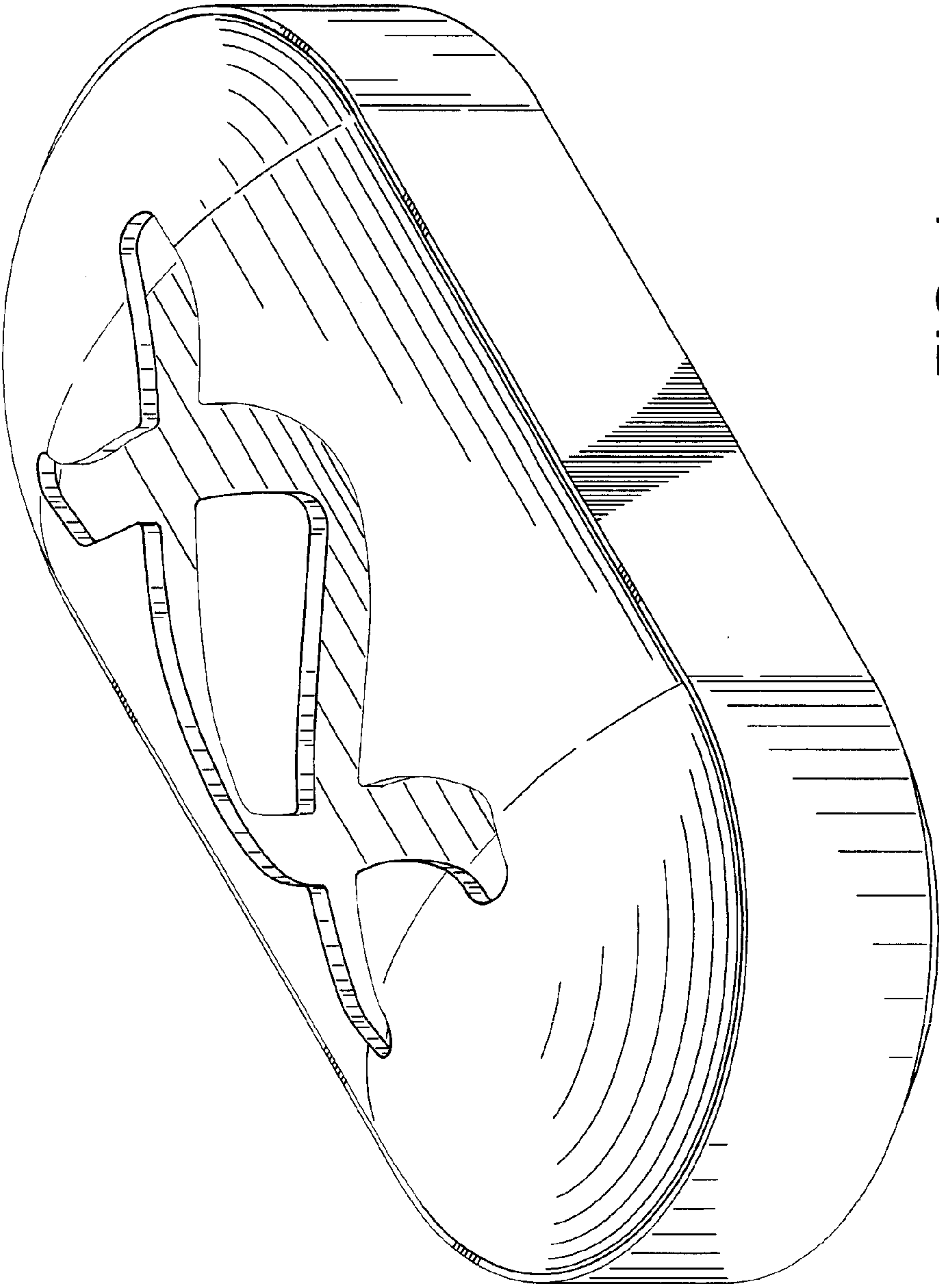

FIG. 1

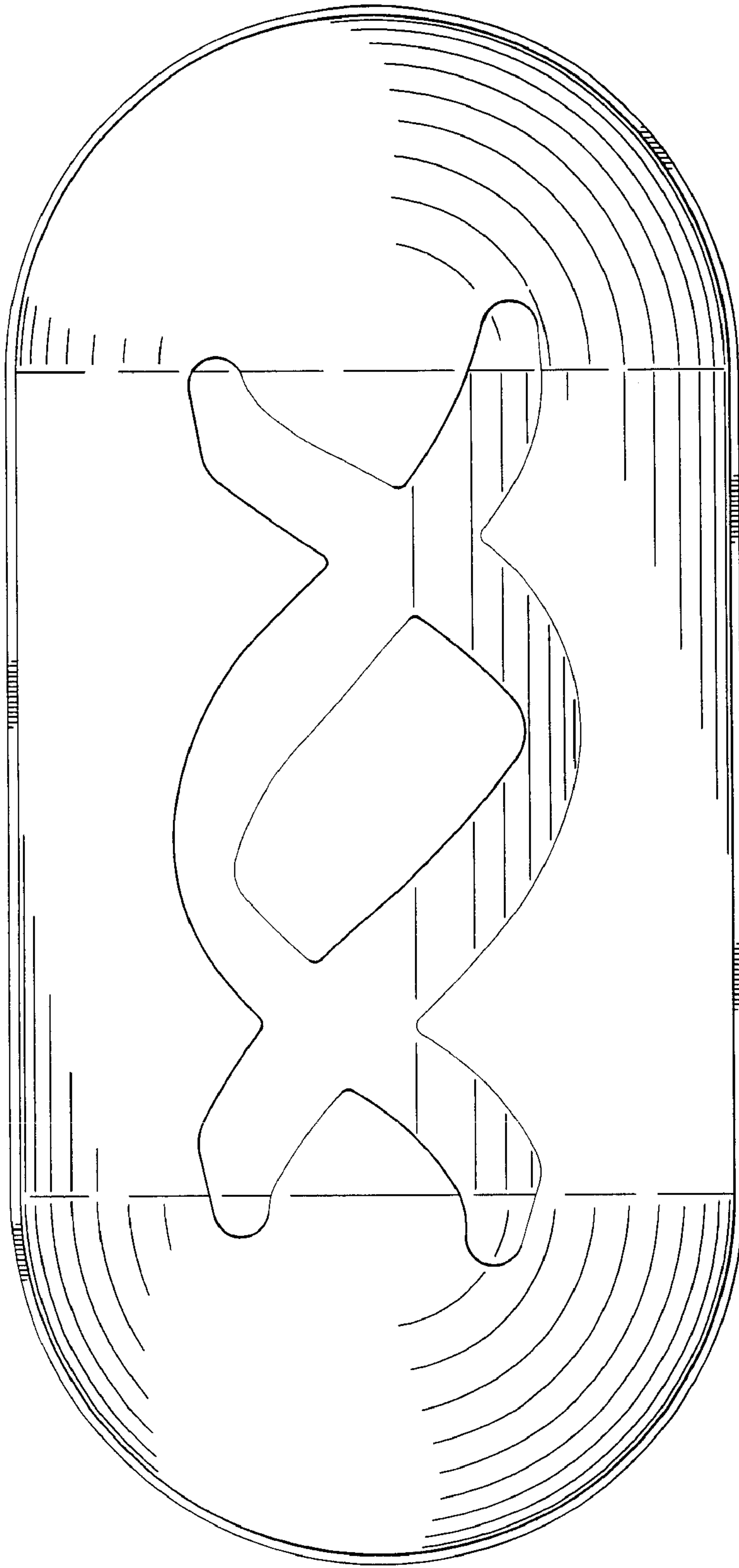

FIG. 2

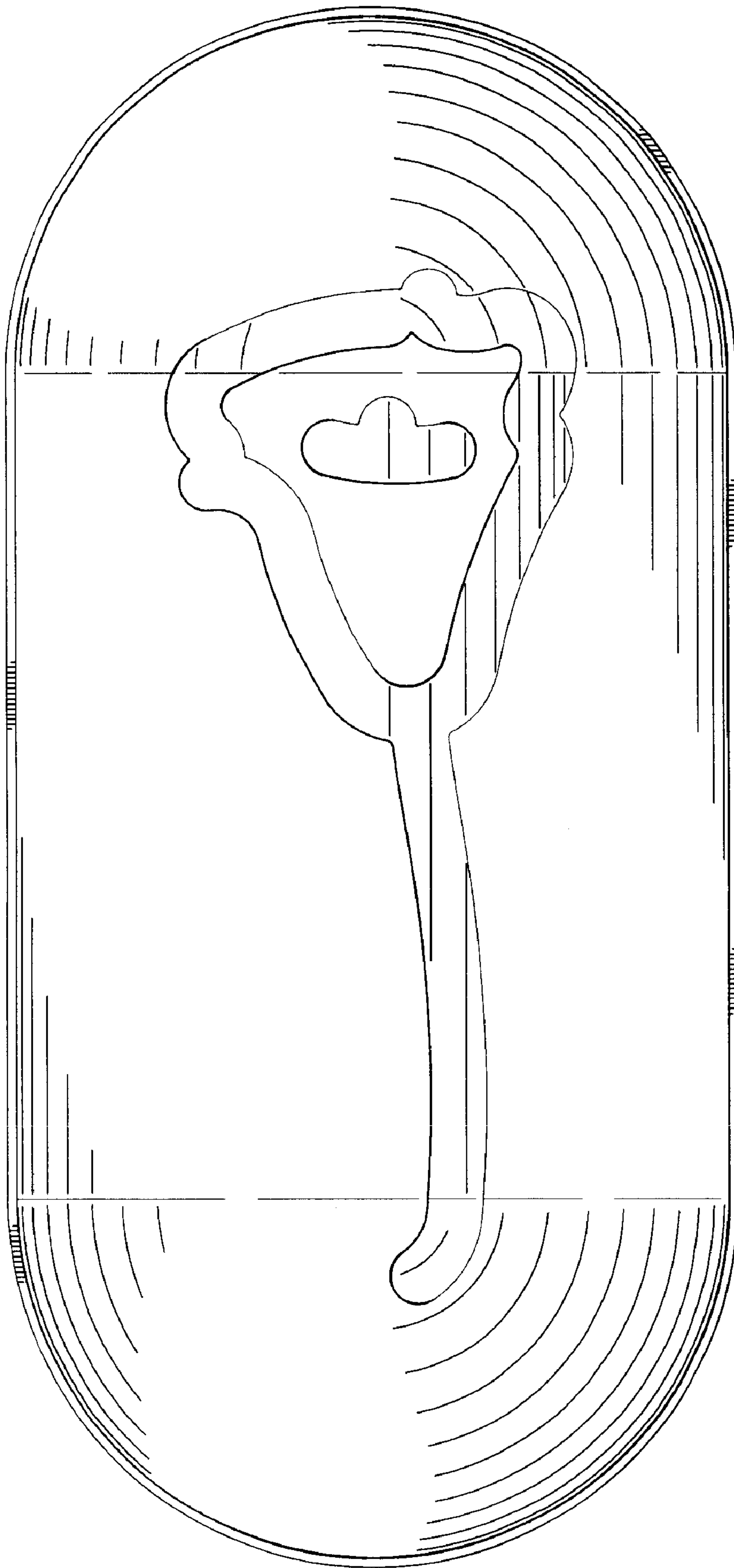

FIG. 3

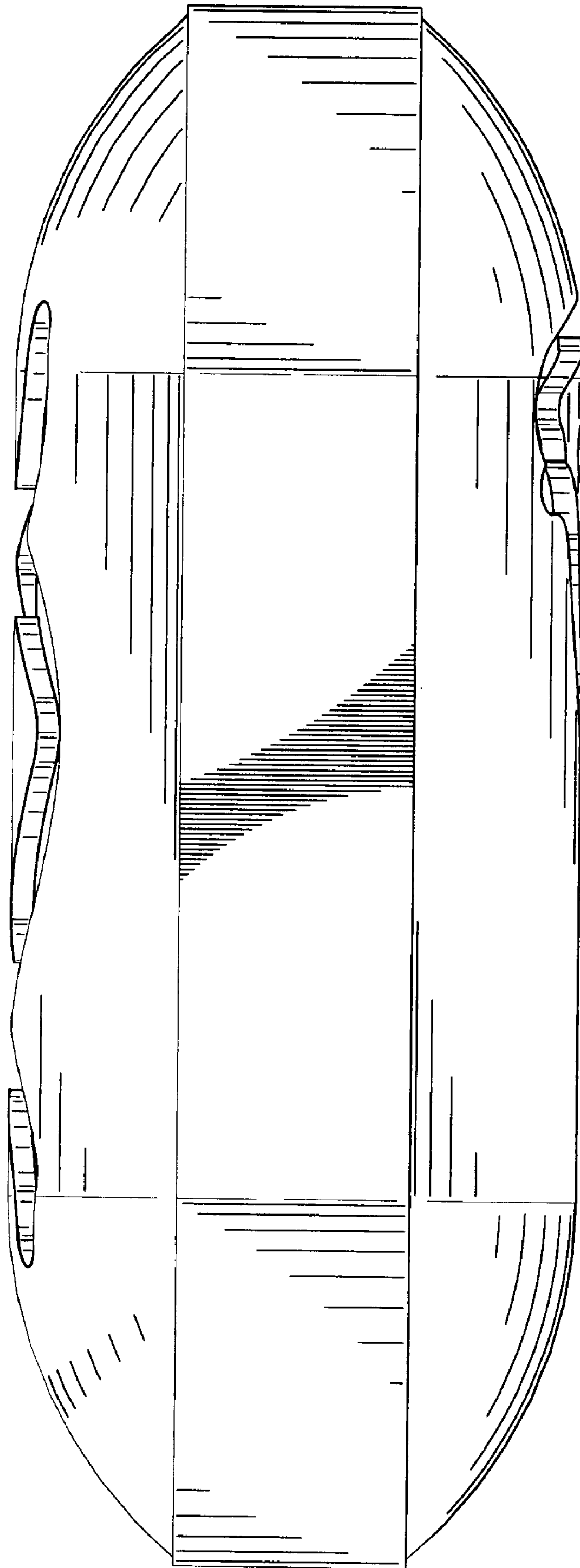

FIG. 4

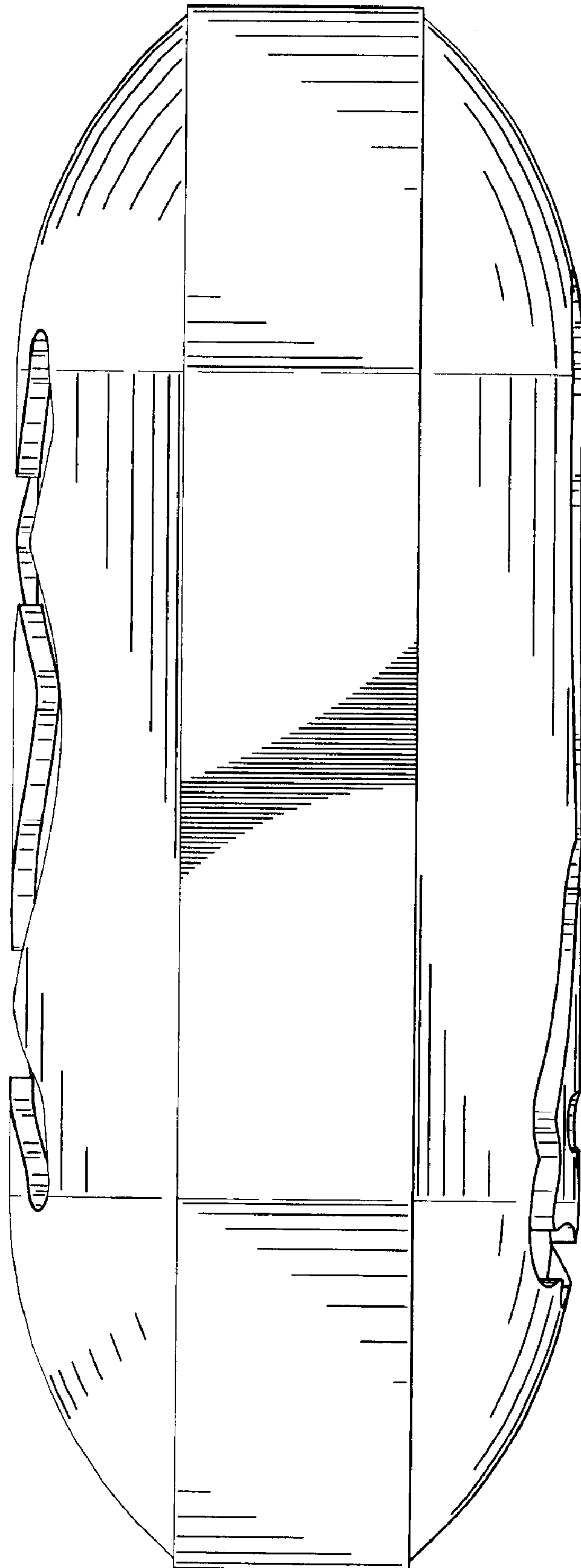

FIG. 5

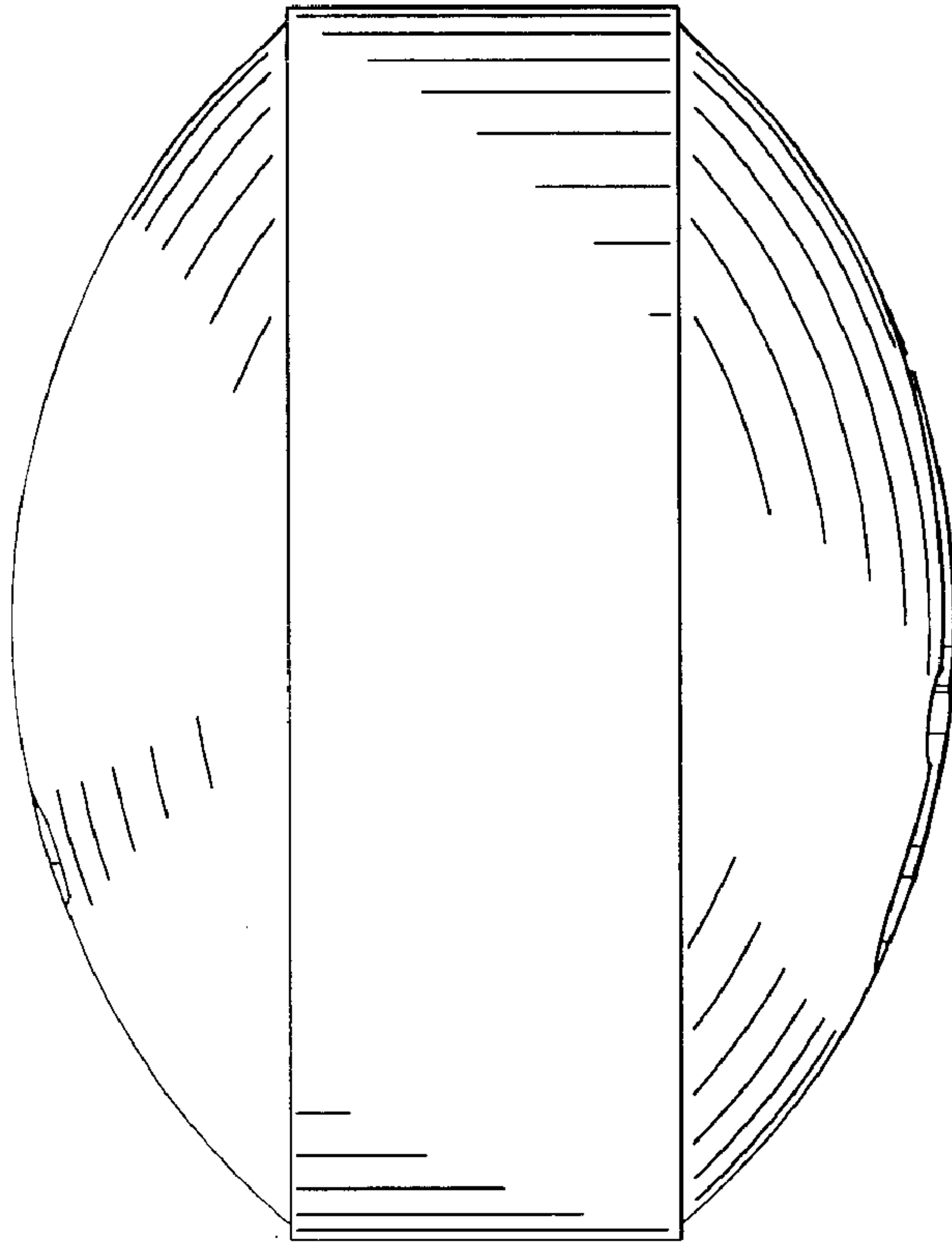

FIG. 7

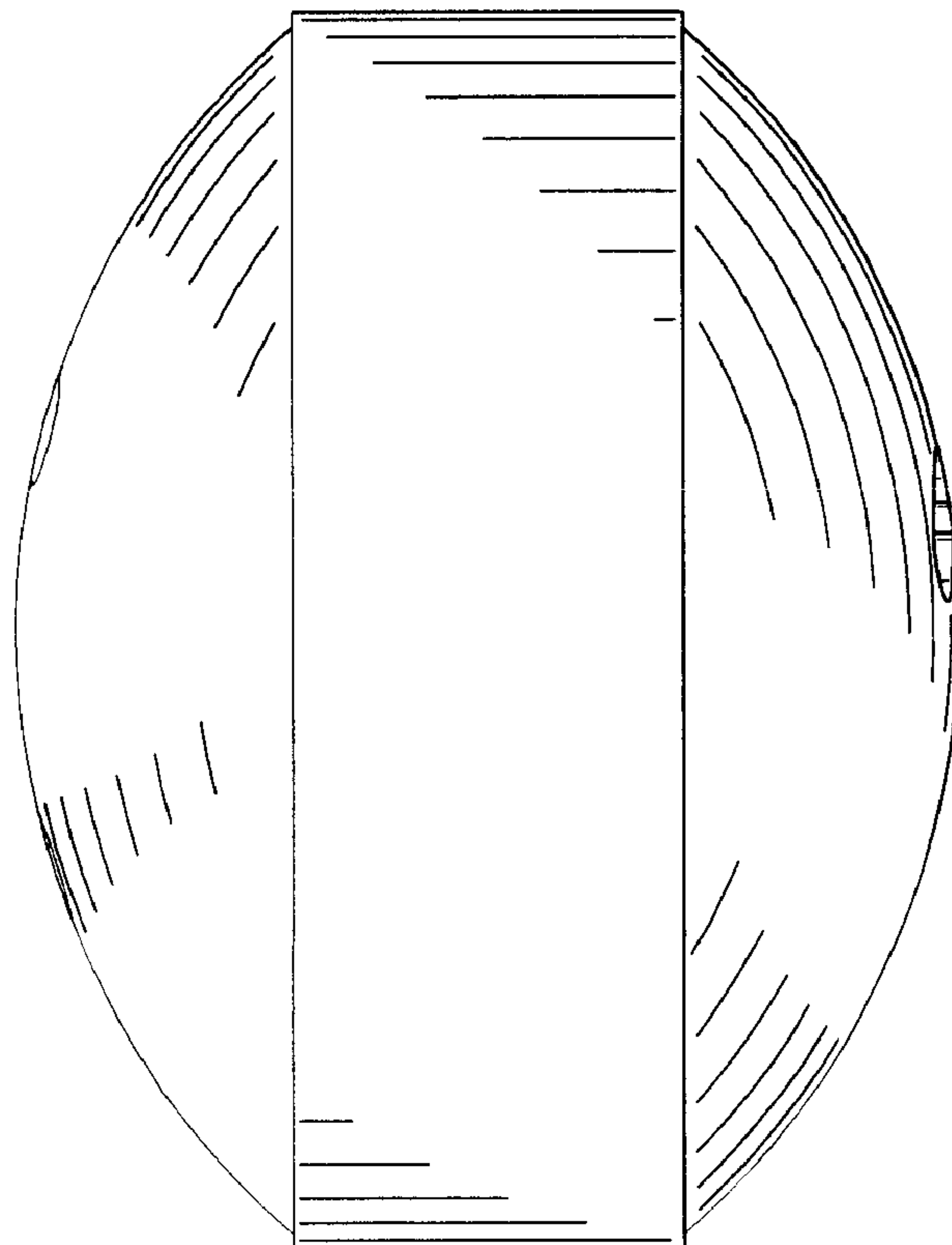

FIG. 6