



US00D534629S

(12) **United States Design Patent**
Bucher et al.

(10) **Patent No.:** **US D534,629 S**
(45) **Date of Patent:** **** Jan. 2, 2007**

(54) **HEATER SUPPORTED BY A ROTATABLE STAND**

(75) Inventors: **John C. Bucher**, Hillsboro Bch, FL (US); **Chad Ricker**, North Lauderdale, FL (US)

(73) Assignee: **King of Fans, Inc.**, Ft. Lauderdale, FL (US)

(**) Term: **14 Years**

(21) Appl. No.: **29/230,075**

(22) Filed: **May 17, 2005**

(51) **LOC (8) Cl.** **23-04**

(52) **U.S. Cl.** **D23/335**

(58) **Field of Classification Search** D23/332, D23/314, 335-338, 340-345, 349-350; 392/360, 392/365-369, 373-376; 312/326; 126/110 B, 126/90 A, 92 A

See application file for complete search history.

(56) **References Cited**

U.S. PATENT DOCUMENTS

D284,504 S	*	7/1986	Okamoto et al.	D23/335
D340,971 S		11/1993	Pirro	D23/370
5,278,936 A		1/1994	Shao	392/365
D348,724 S		7/1994	Lee	D23/328
D395,490 S	*	6/1998	Jane' et al.	D23/337
D410,074 S		5/1999	Lee	D23/332
D429,323 S		8/2000	Rossman et al.	D23/341
D431,640 S	*	10/2000	Rong	D23/335
D448,071 S	*	9/2001	Birdsell et al.	D23/335

D462,429 S	*	9/2002	Gao	D23/335
D462,753 S	*	9/2002	Gao	D23/335
D467,324 S	*	12/2002	Ching	D23/335
D467,325 S	*	12/2002	Ching	D23/335
D468,415 S		1/2003	Moreno et al.	D23/341
D476,404 S		6/2003	Chen et al.	D23/341
D476,724 S		7/2003	Chuang et al.	D23/335
D483,102 S	*	12/2003	Ching	D23/335

* cited by examiner

Primary Examiner—Brian N Vinson

(74) *Attorney, Agent, or Firm*—Brian S. Steinberger; Law Offices of Brian S. Steinberger, P.A.

(57) **CLAIM**

The ornamental design for a novel heater supported by a rotatable stand, as shown and described.

DESCRIPTION

FIG. 1 is a right front perspective view of the novel heater supported by a rotatable stand showing our new design; FIG. 2 is a left front perspective view thereof; FIG. 3 is a right rear perspective view thereof; FIG. 4 is a left rear perspective view thereof; FIG. 5 is a left side view thereof; FIG. 6 is a right side view thereof; FIG. 7 is a front view thereof; FIG. 8 is a rear view of thereof; FIG. 9 is top perspective view thereof; and FIG. 10 is bottom view thereof.

The broken-line disclosure in the views is for illustrative purposes only and forms no part of the claimed design.

1 Claim, 10 Drawing Sheets

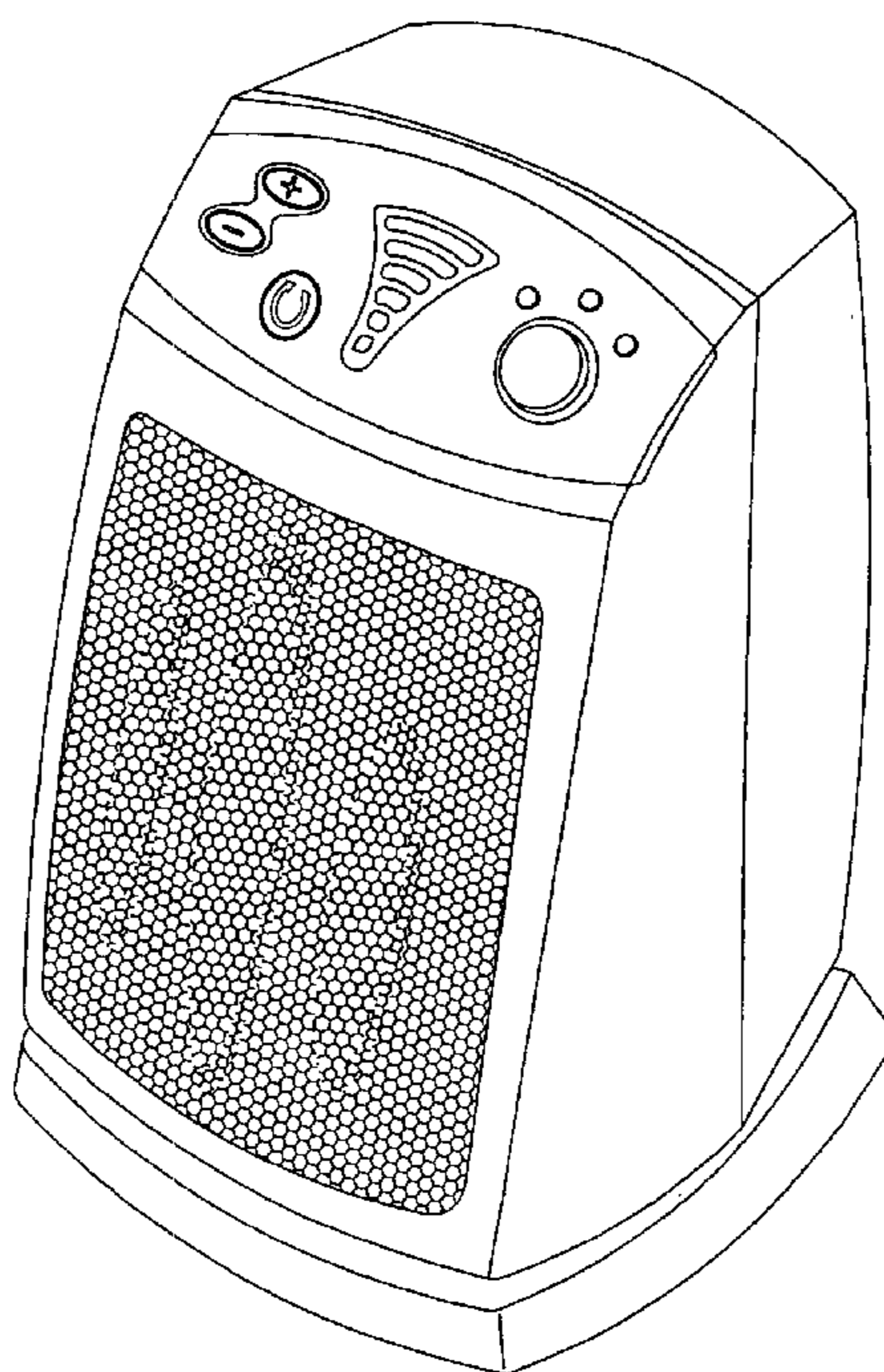

FIG. 1

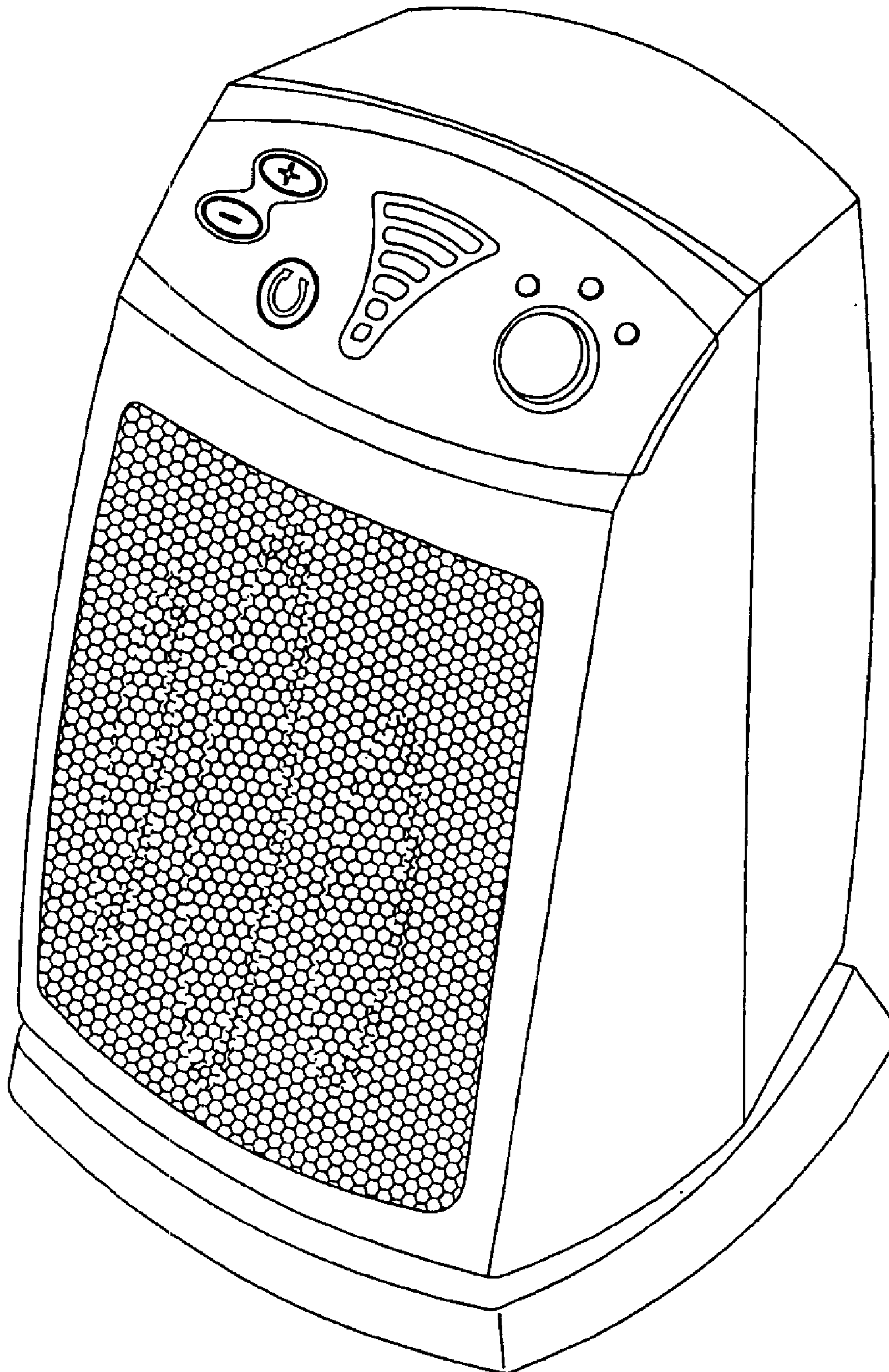

FIG. 2

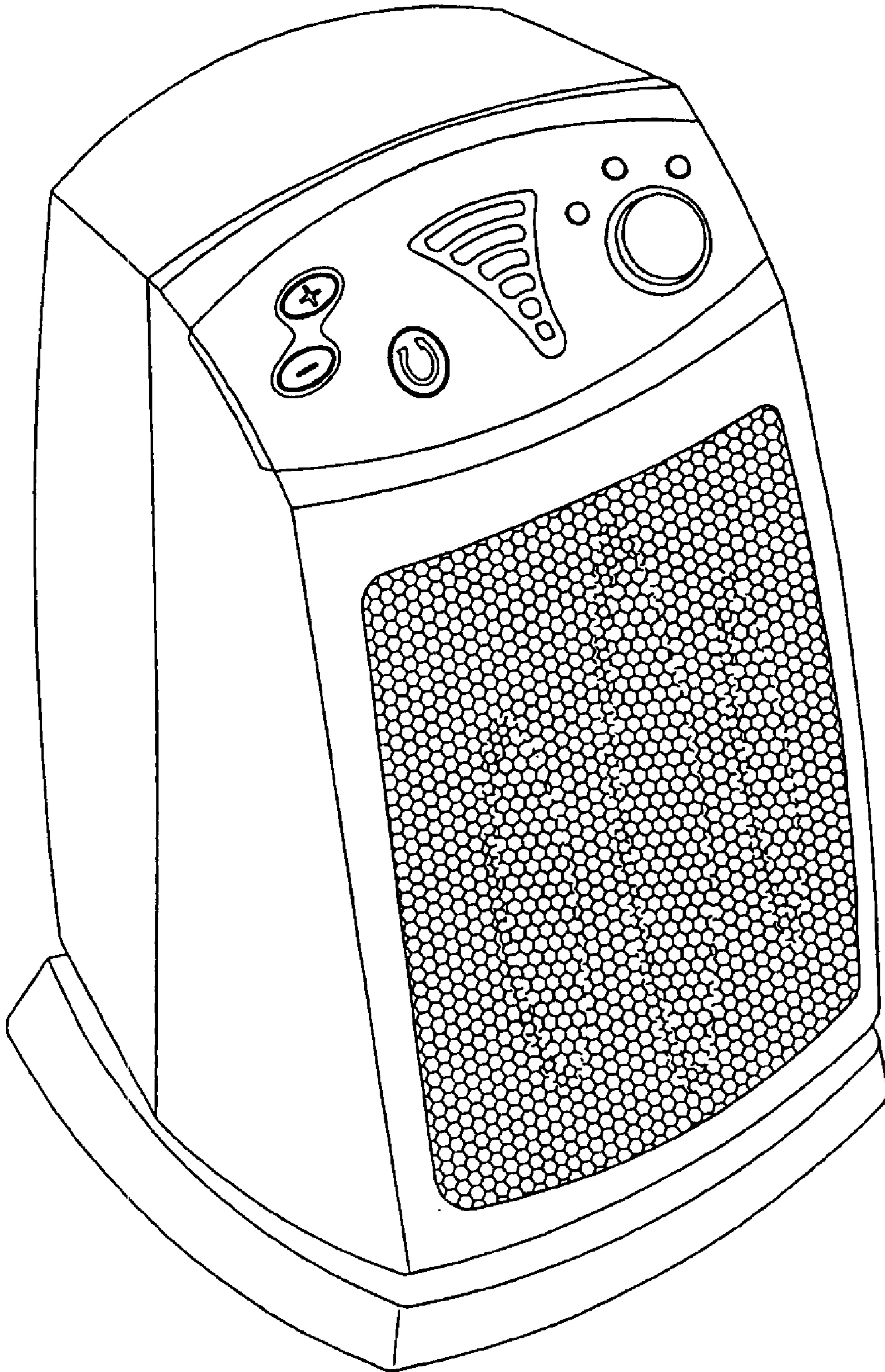

FIG. 3

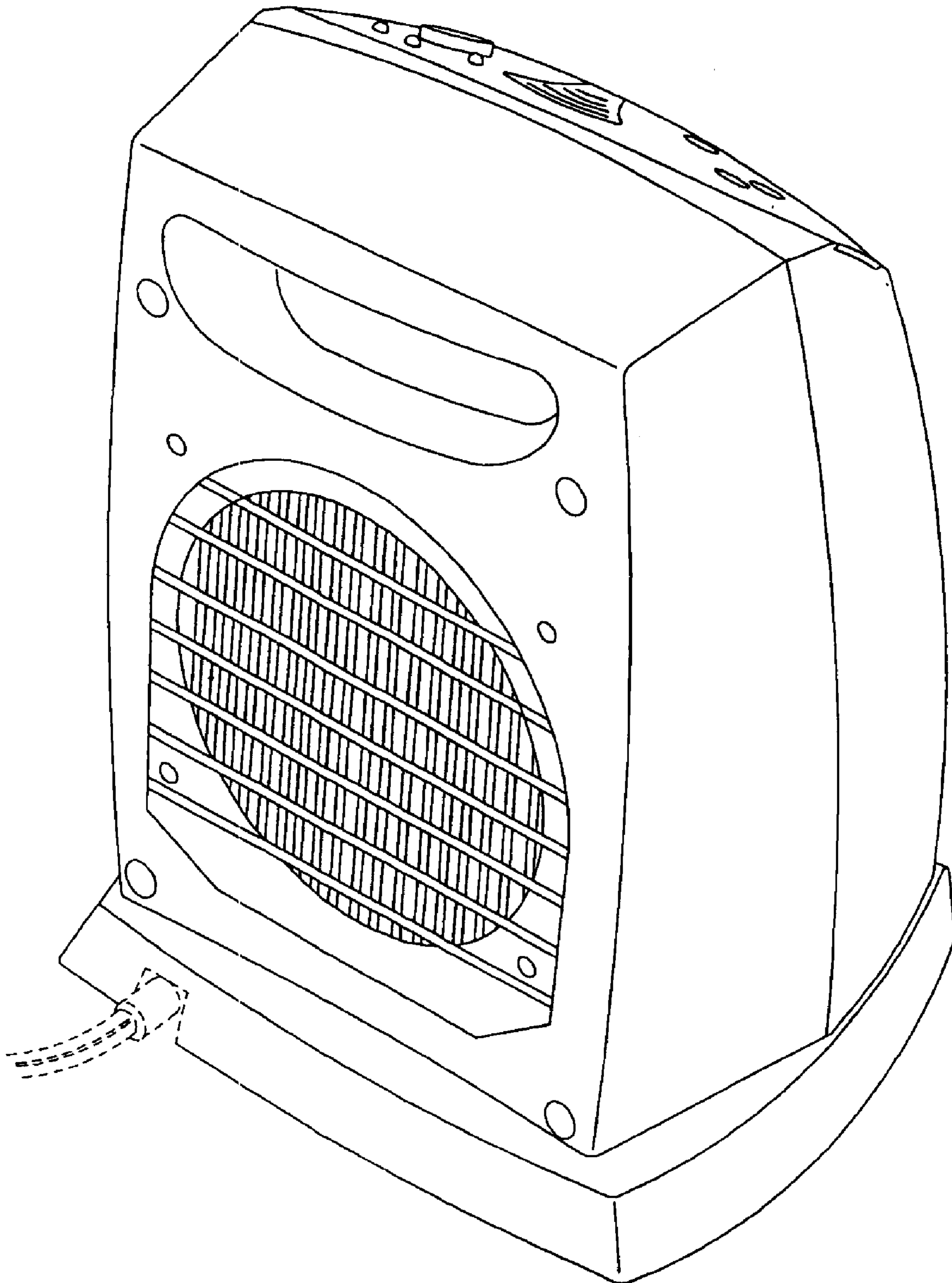

FIG. 4

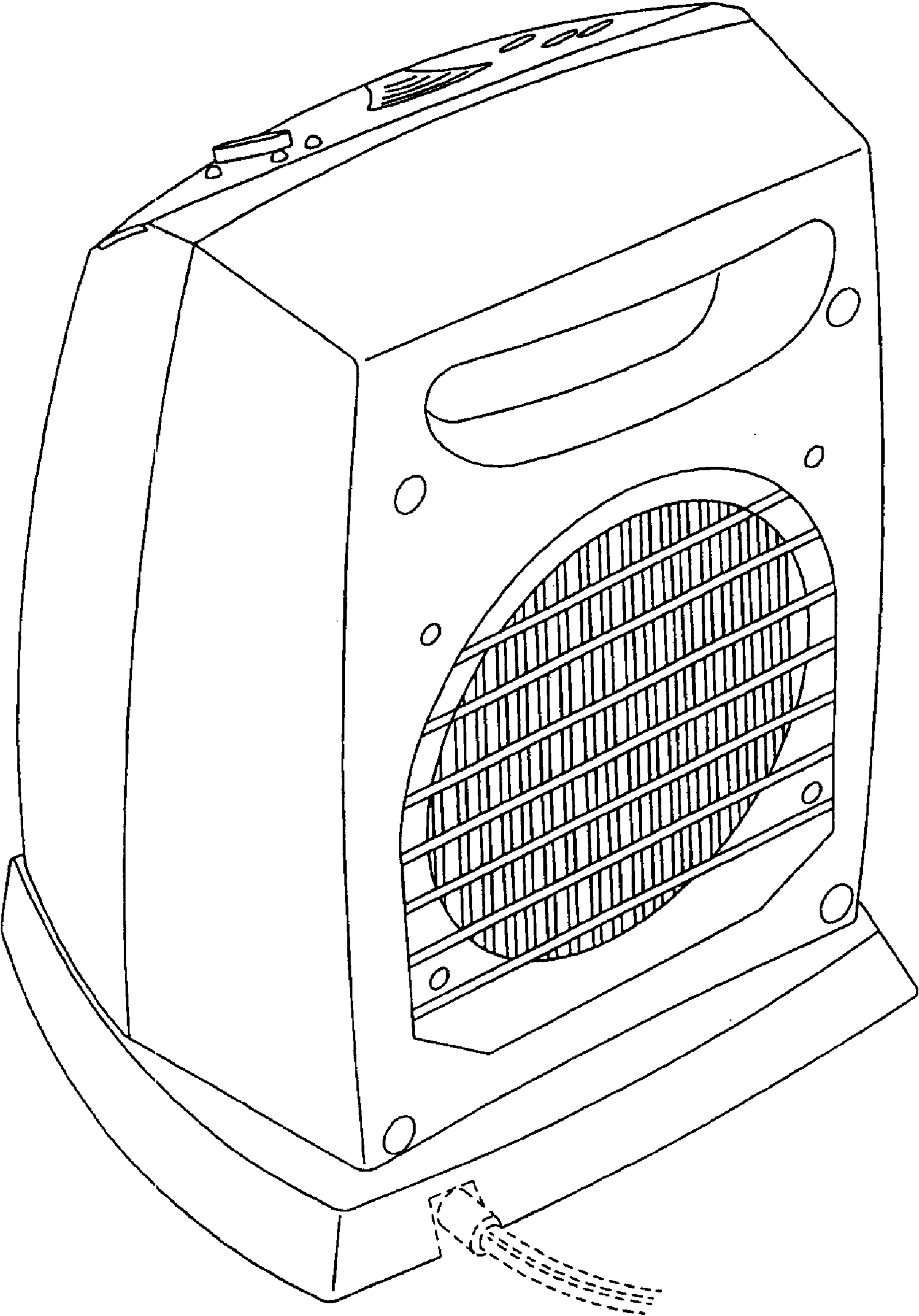

FIG. 5

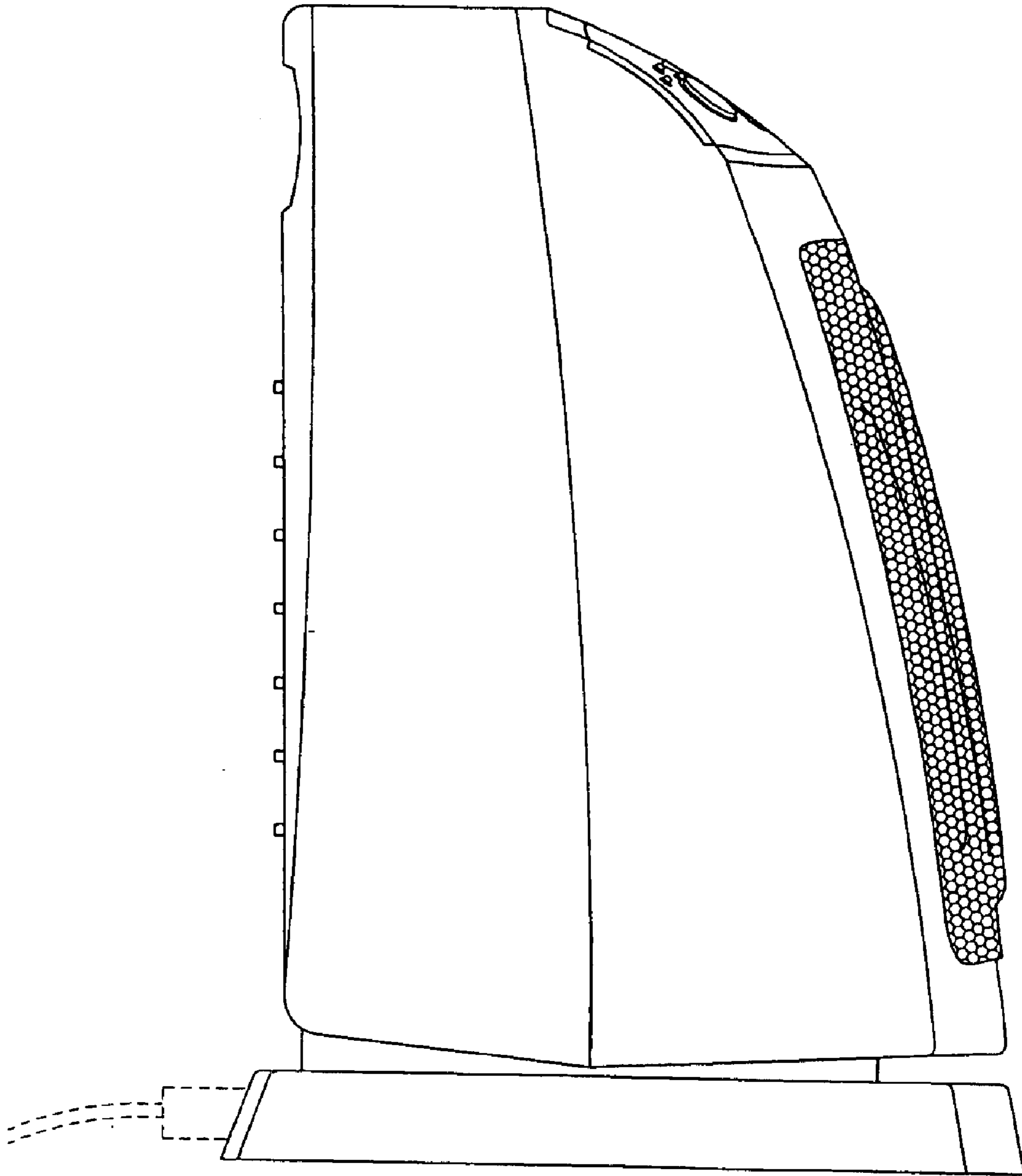

FIG. 6

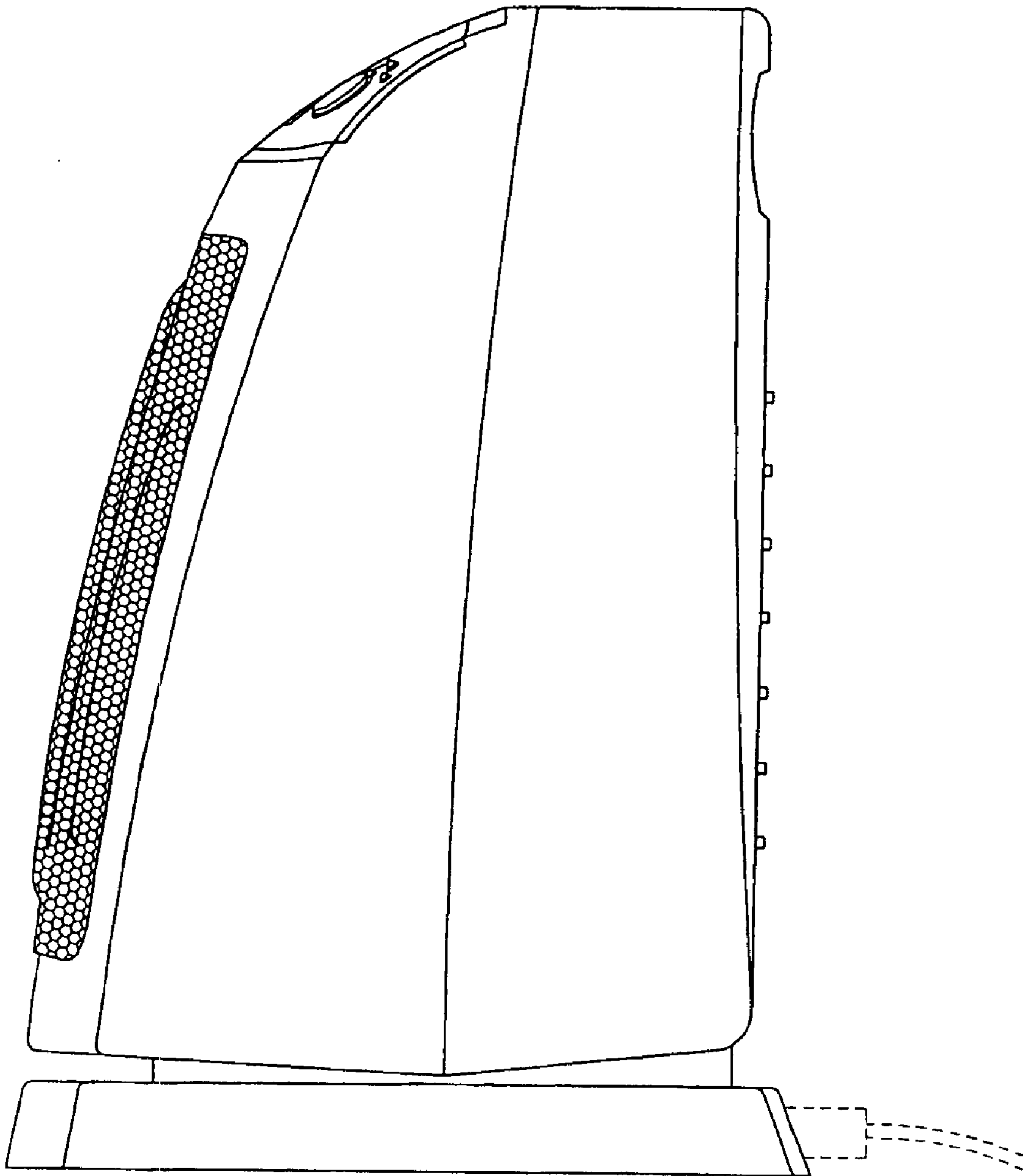

FIG. 7

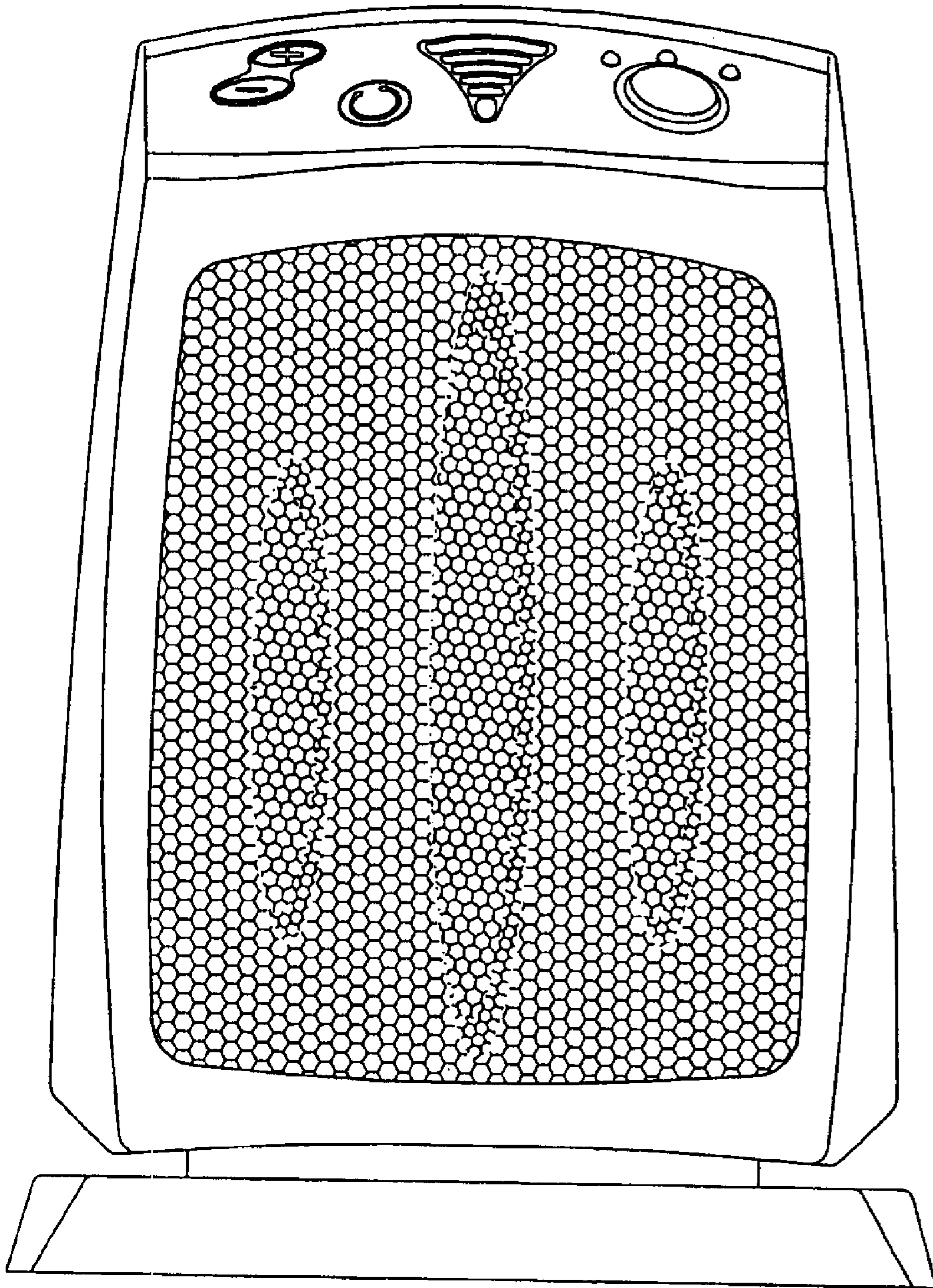

FIG. 8

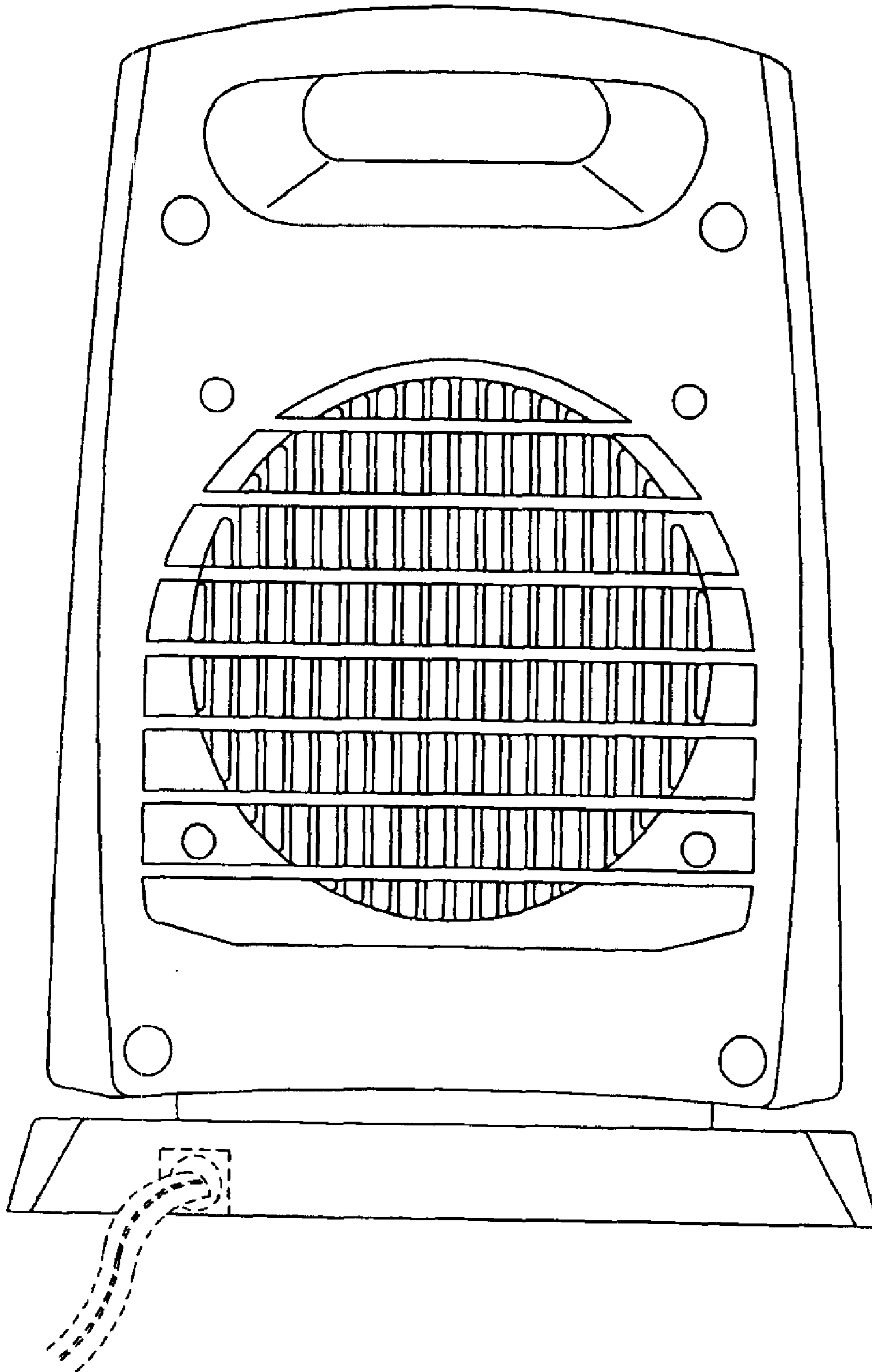

FIG. 9

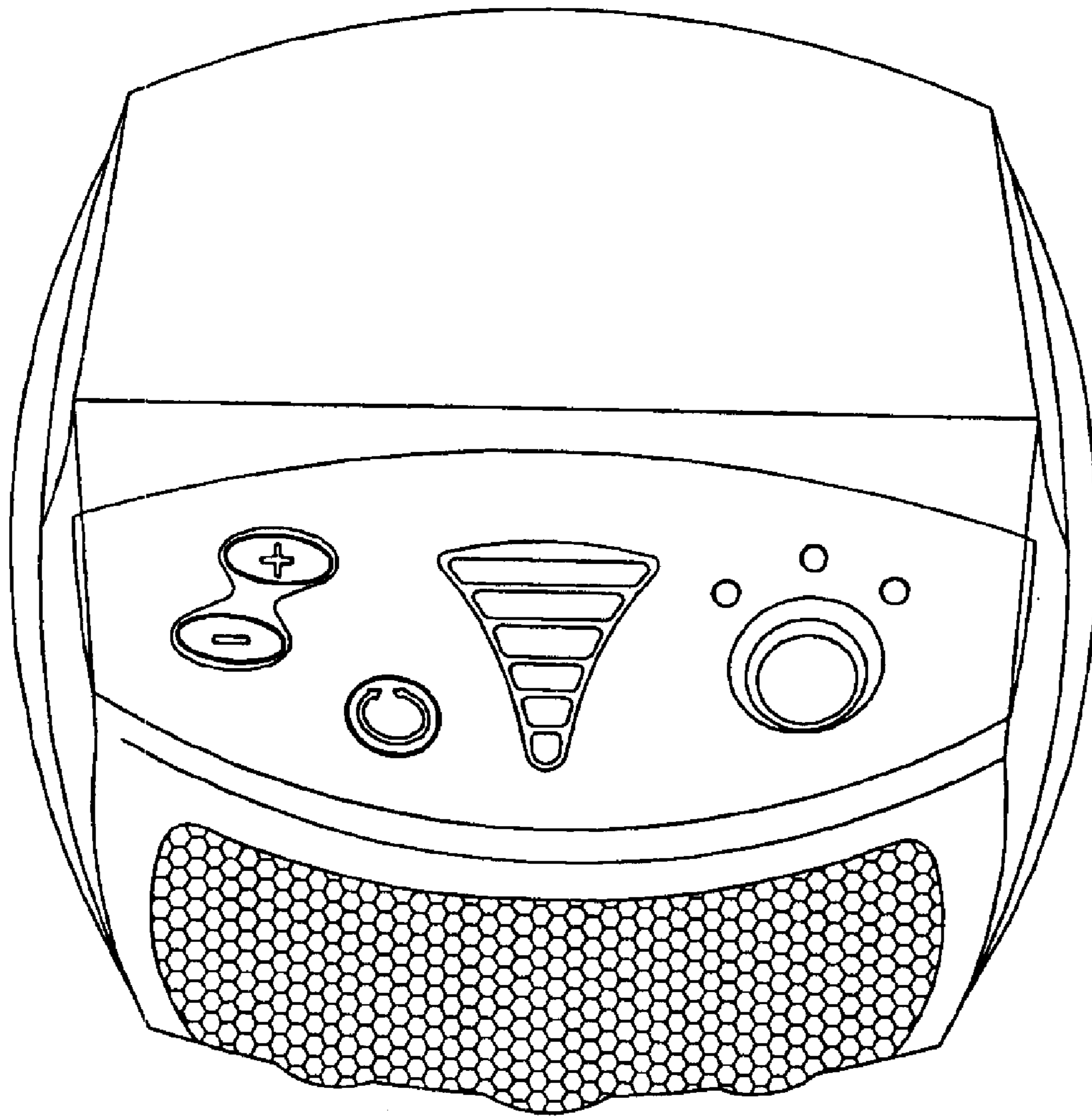

FIG. 10

