



US00D534622S

(12) **United States Design Patent**
Chu et al.

(10) **Patent No.:** **US D534,622 S**

(45) **Date of Patent:** **** Jan. 2, 2007**

(54) **FAUCET**

(75) Inventors: **Aaron Chu**, Taichung (TW); **Ken Hsui**,
Taichung (TW); **Jau-Chi Lai**, Taichung
(TW)

(73) Assignee: **Globe Union Industrial Corp.**,
Taichung (TW)

(**) Term: **14 Years**

(21) Appl. No.: **29/258,601**

(22) Filed: **Apr. 25, 2006**

(51) **LOC (8) Cl.** **23-01**

(52) **U.S. Cl.** **D23/238**

(58) **Field of Classification Search** D23/238-257;
4/675-678; 137/801

See application file for complete search history.

(56) **References Cited**

U.S. PATENT DOCUMENTS

- D438,934 S * 3/2001 Mark et al. D23/238
- D443,337 S * 6/2001 Mark et al. D23/238
- D444,212 S * 6/2001 Fleischmann D23/243

- D470,224 S * 2/2003 Hanna D23/238
- D487,798 S * 3/2004 Bayer D23/238
- D488,210 S * 4/2004 Lord D23/238
- D499,795 S * 12/2004 Bayer D23/238
- D511,560 S * 11/2005 Kulig et al. D23/238
- D519,190 S * 4/2006 Lord D23/238

* cited by examiner

Primary Examiner—Louis S. Zarfes

Assistant Examiner—Gregory Andoll

(74) *Attorney, Agent, or Firm*—Troxell Law Office, PLLC

(57) **CLAIM**

I claim the ornamental design for a faucet, as shown and described.

DESCRIPTION

FIG. 1 is a front perspective view of a faucet showing my new design;

FIG. 2 is a front elevational view thereof;

FIG. 3 is a rear elevational view thereof;

FIG. 4 is a left side elevational view thereof;

FIG. 5 is a right side elevational view thereof; and,

FIG. 6 is a top plan view thereof.

1 Claim, 6 Drawing Sheets

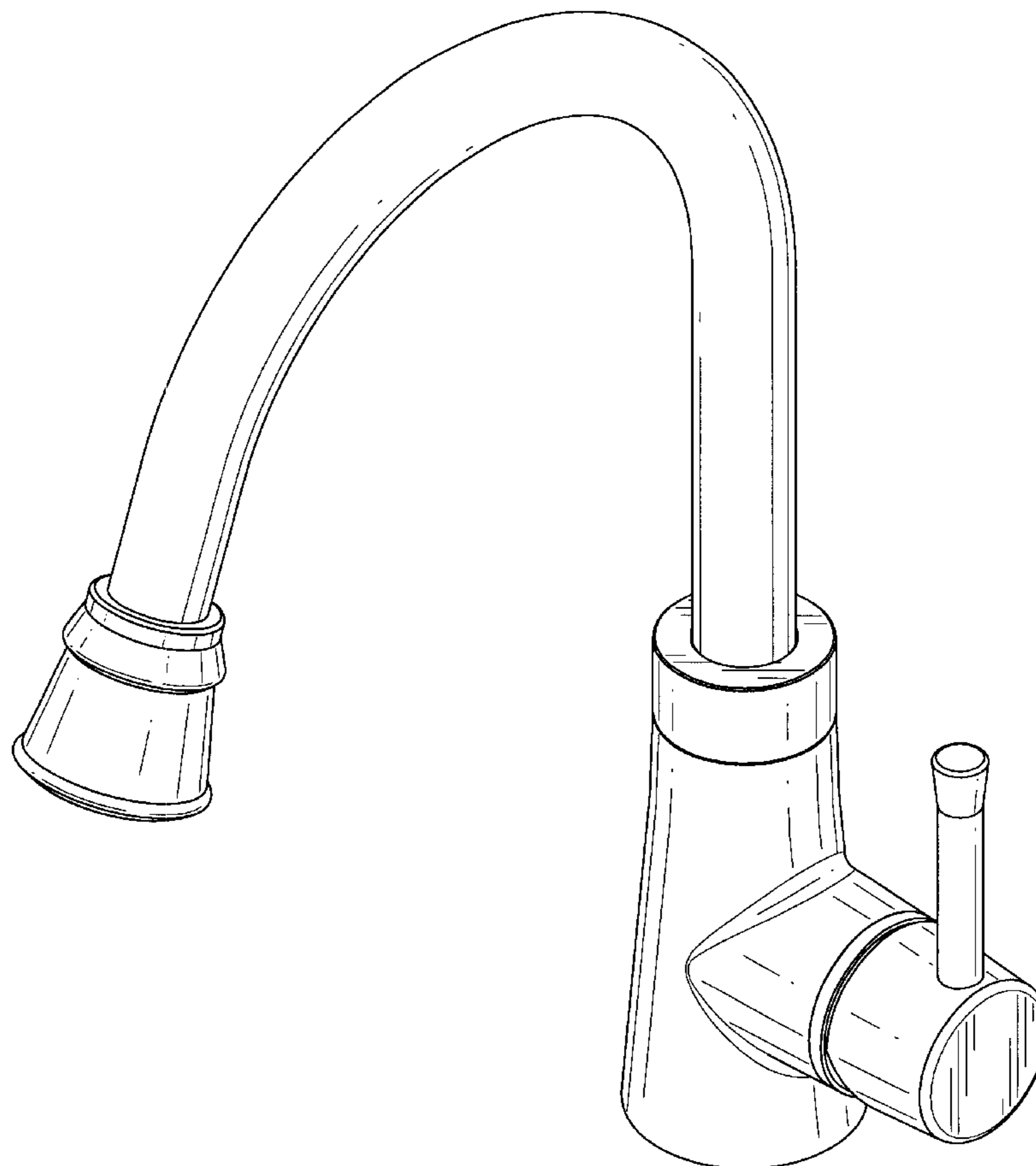

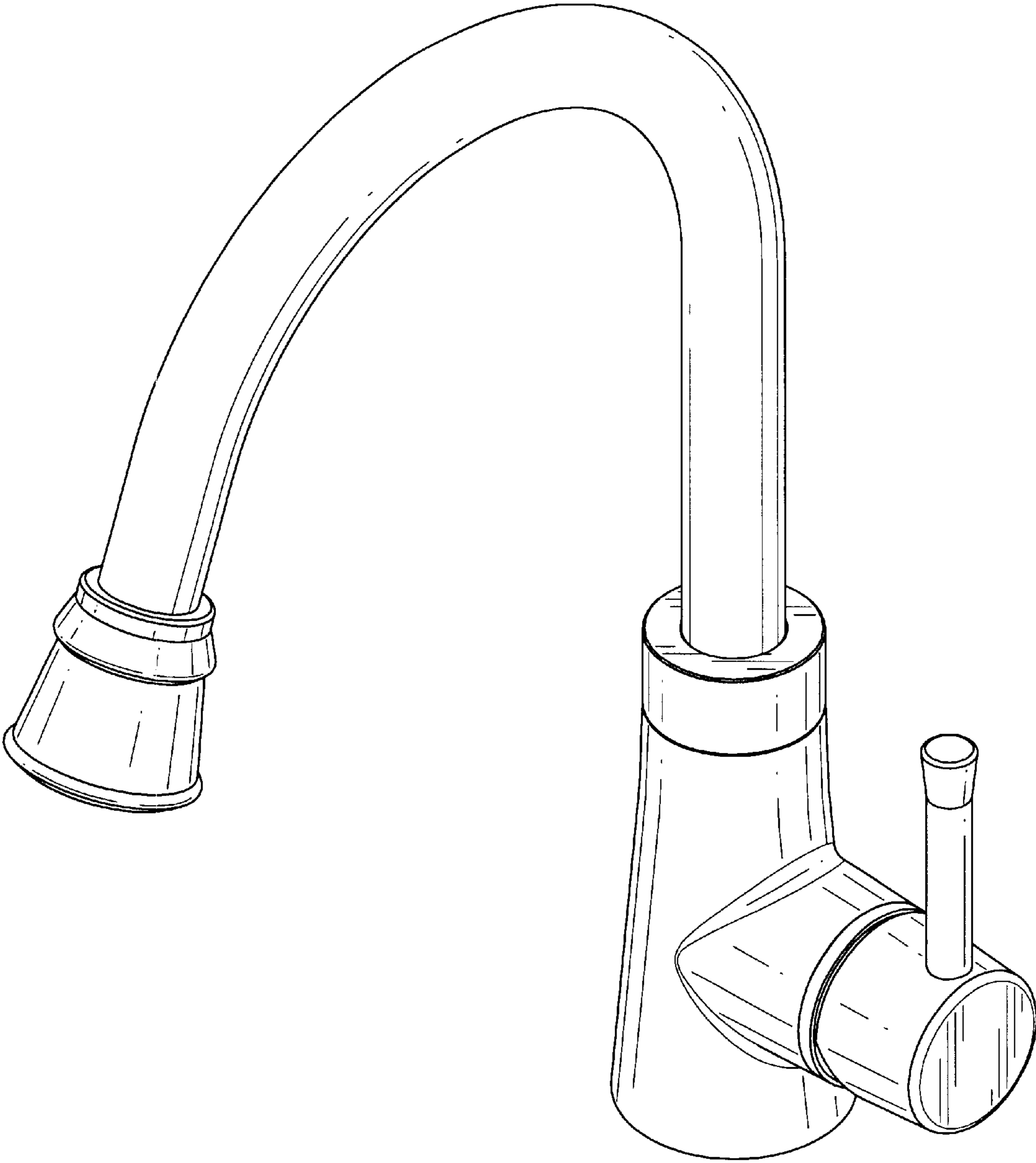

FIG. 1

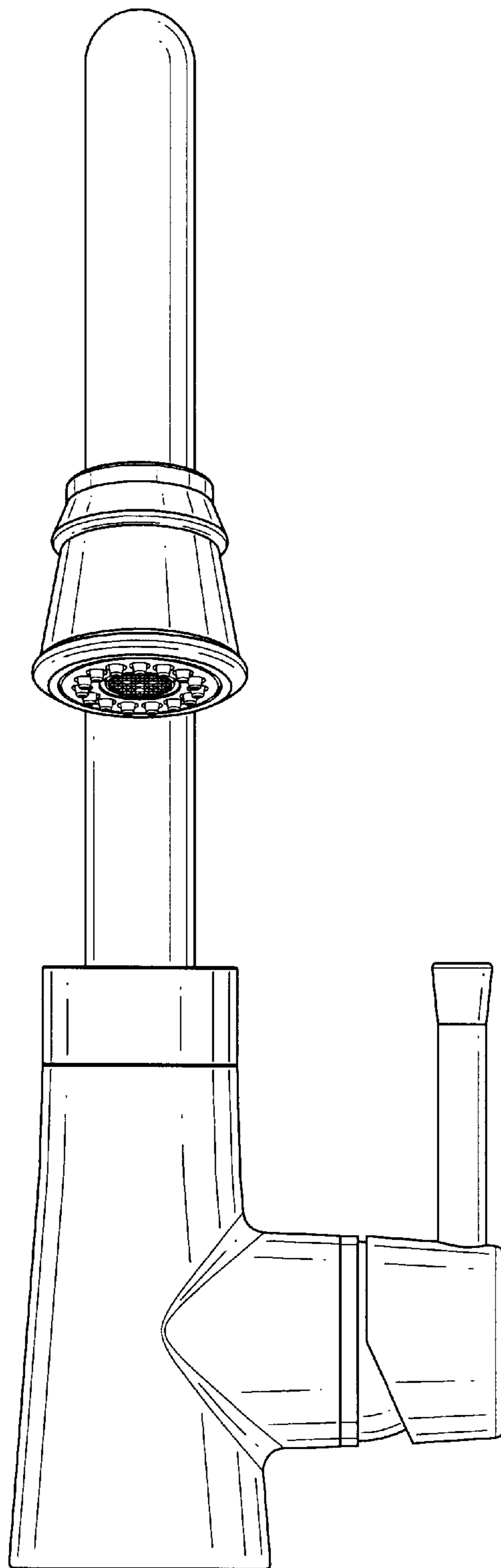

FIG. 2

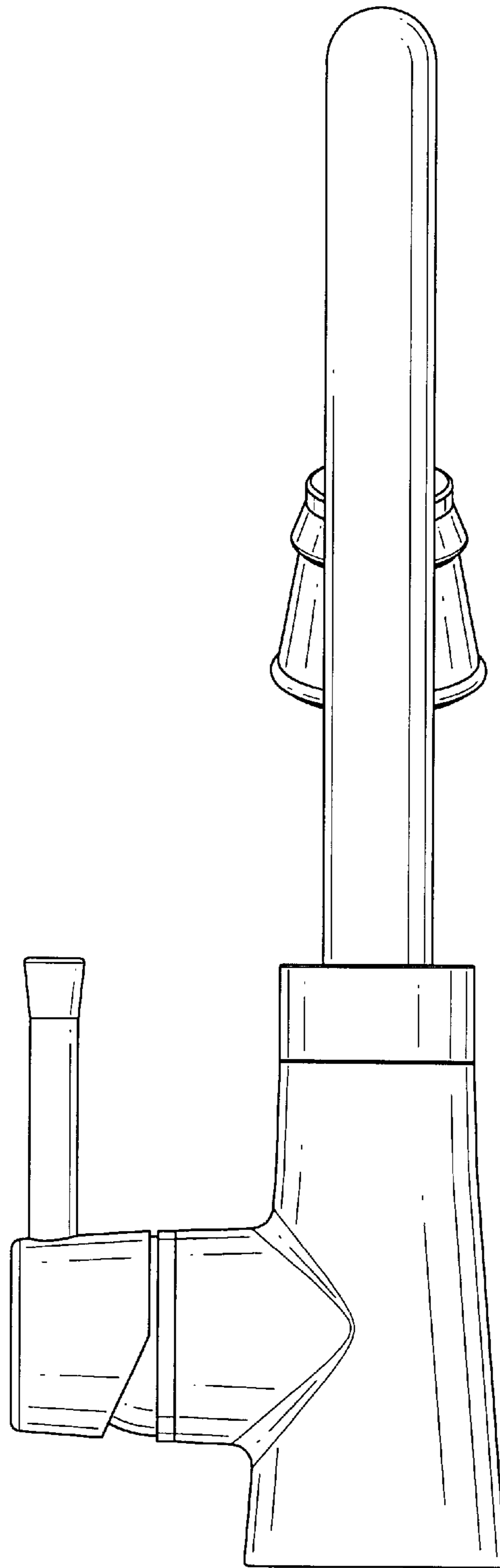

FIG. 3

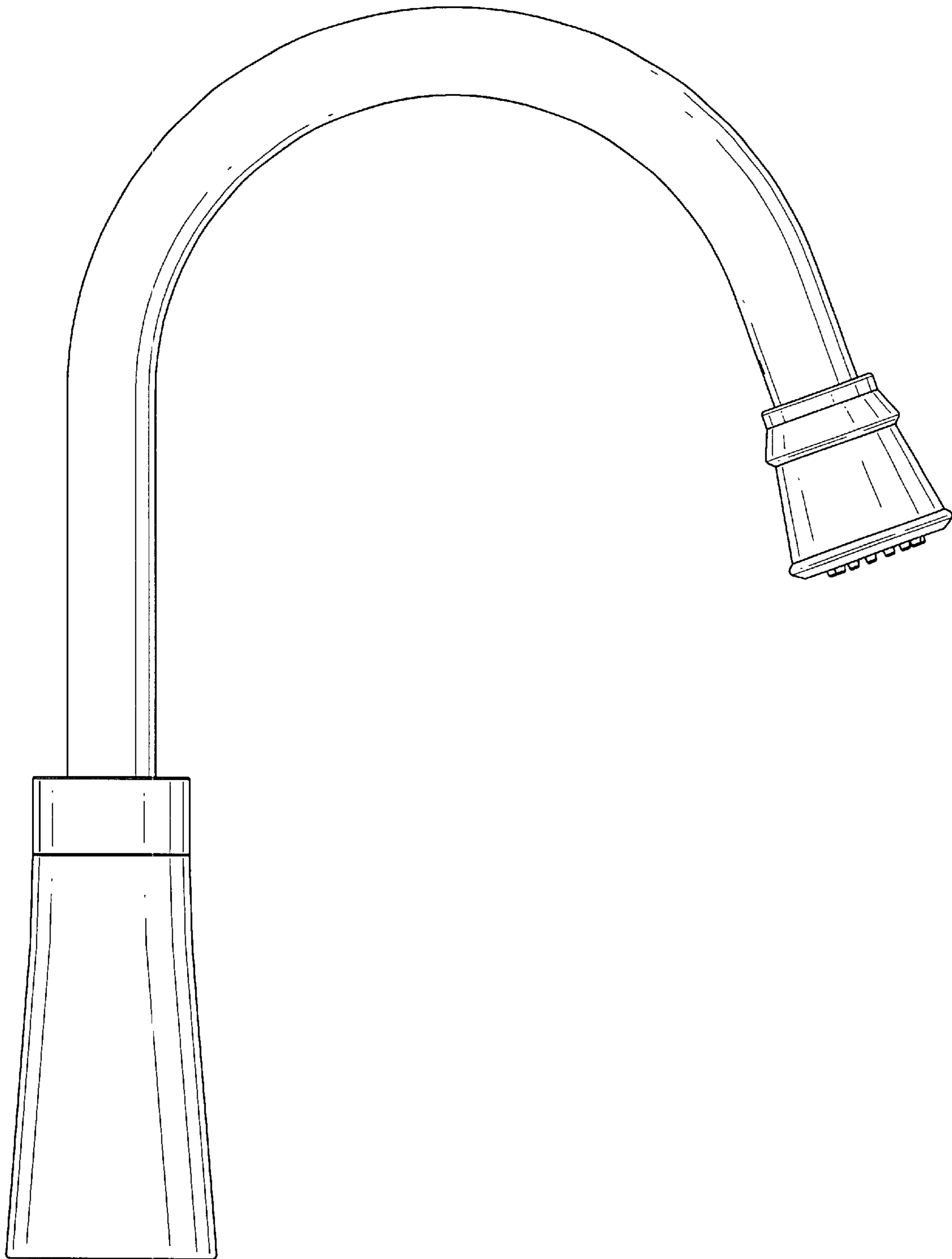

FIG. 4

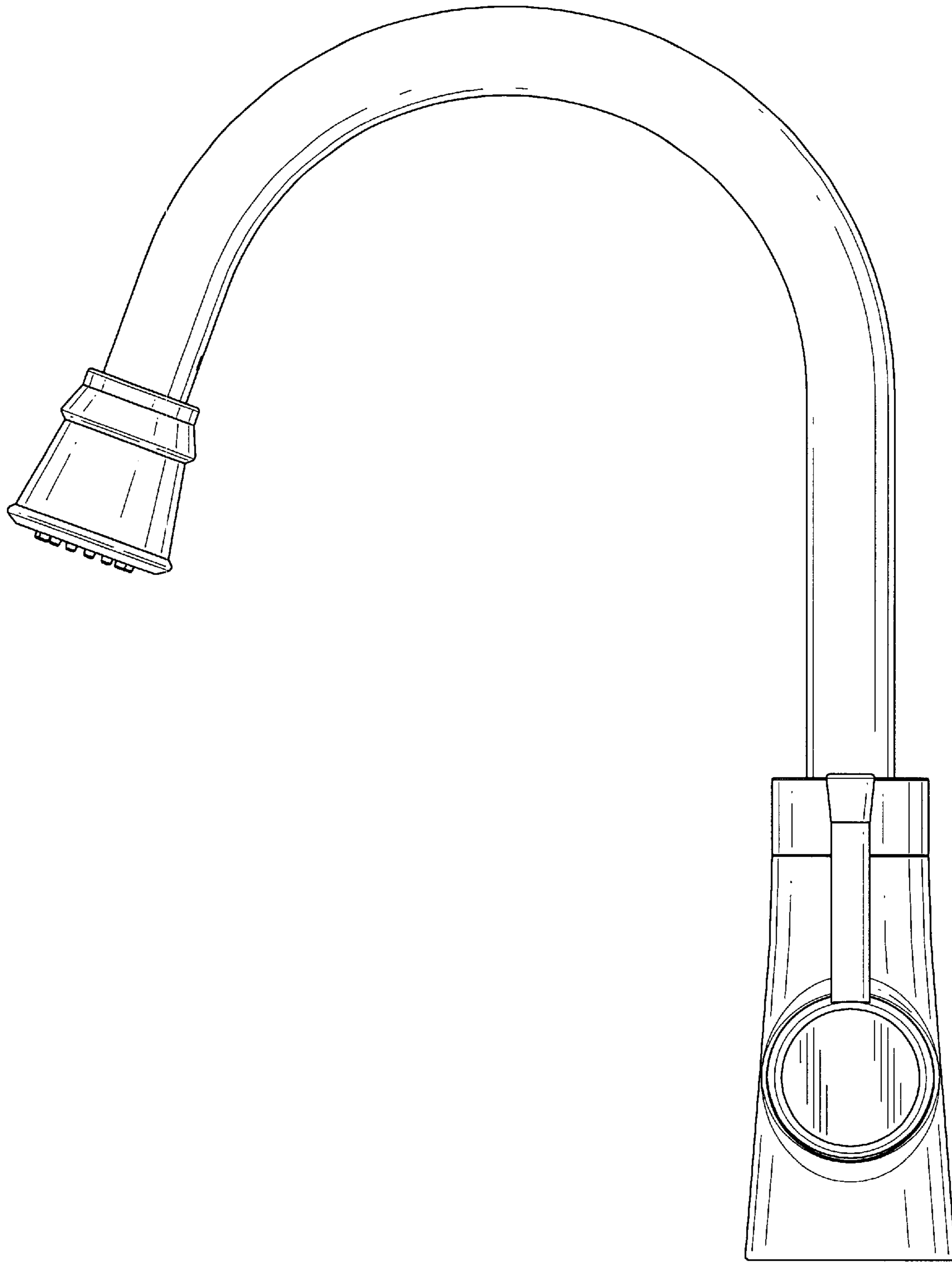

FIG. 5

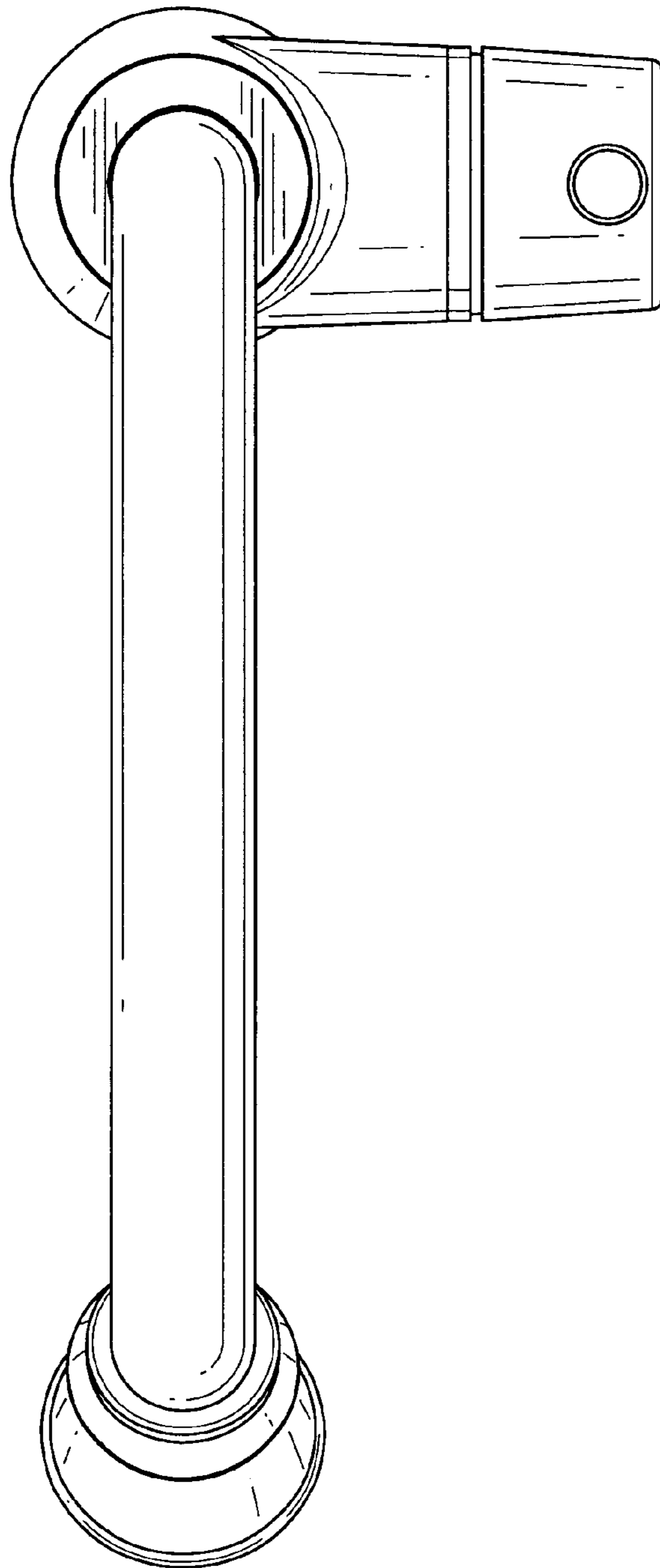

FIG. 6