



US00D534598S

(12) **United States Design Patent**
Barez et al.

(10) **Patent No.:** **US D534,598 S**
(45) **Date of Patent:** **** Jan. 2, 2007**

(54) **GOLF CLUB HEAD**

(75) Inventors: **Craig Kevin Barez**, Temecula, CA (US); **Todd P. Beach**, San Diego, CA (US); **Joseph Henry Hoffman**, Carlsbad, CA (US); **Robert Nunez**, San Pedro, CA (US); **Allan Capili Saliba**, Oceanside, CA (US); **Sean Toulon**, Vista, CA (US)

(73) Assignee: **Taylor Made Golf Company, Inc.**, Carlsbad, CA (US)

(**) Term: **14 Years**

(21) Appl. No.: **29/241,307**

(22) Filed: **Oct. 25, 2005**

(51) **LOC (8) Cl.** **21-02**

(52) **U.S. Cl.** **D21/752**

(58) **Field of Classification Search** D21/733,
D21/752, 759; 473/324-331, 343-346
See application file for complete search history.

(56) **References Cited**

U.S. PATENT DOCUMENTS

D247,922 S	*	5/1978	Sheldon	D21/752
D469,141 S	*	1/2003	Poynor et al.	D21/759
D479,867 S	*	9/2003	Saliba et al.	D21/752
D482,093 S	*	11/2003	Imamoto	D21/759
D499,158 S	*	11/2004	Imamoto	D21/752

D501,235 S	*	1/2005	Imamoto	D21/752
D513,051 S		12/2005	Barez et al.		
D514,185 S		1/2006	Barez et al.		
D516,652 S		3/2006	Barez et al.		
D518,129 S	*	3/2006	Poynor et al.	D21/759
D519,589 S	*	4/2006	Barez et al.	D21/733
D521,091 S	*	5/2006	Mahaffey et al.	D21/752

* cited by examiner

Primary Examiner—Mitchell Siegel

(74) *Attorney, Agent, or Firm*—Klarquist Sparkman, LLP

(57) **CLAIM**

We claim the ornamental design for a golf club head, as shown and described.

DESCRIPTION

FIG. 1 is a perspective view of a golf club head, as viewed from the rear, bottom, and one side thereof, according to one embodiment.

FIG. 2 is a front elevation view of the club head of FIG. 1.

FIG. 3 is a rear elevation view of the club head of FIG. 1.

FIG. 4 is a side heel elevation view of the club head of FIG. 1.

FIG. 5 is a side toe elevation view of the club head of FIG. 1.

FIG. 6 is a top plan view of the club head of FIG. 1; and, FIG. 7 is a bottom plan view of the club head of FIG. 1.

The dashed lines in the drawings are for illustrative purposes only and form no part of the claimed design.

1 Claim, 3 Drawing Sheets

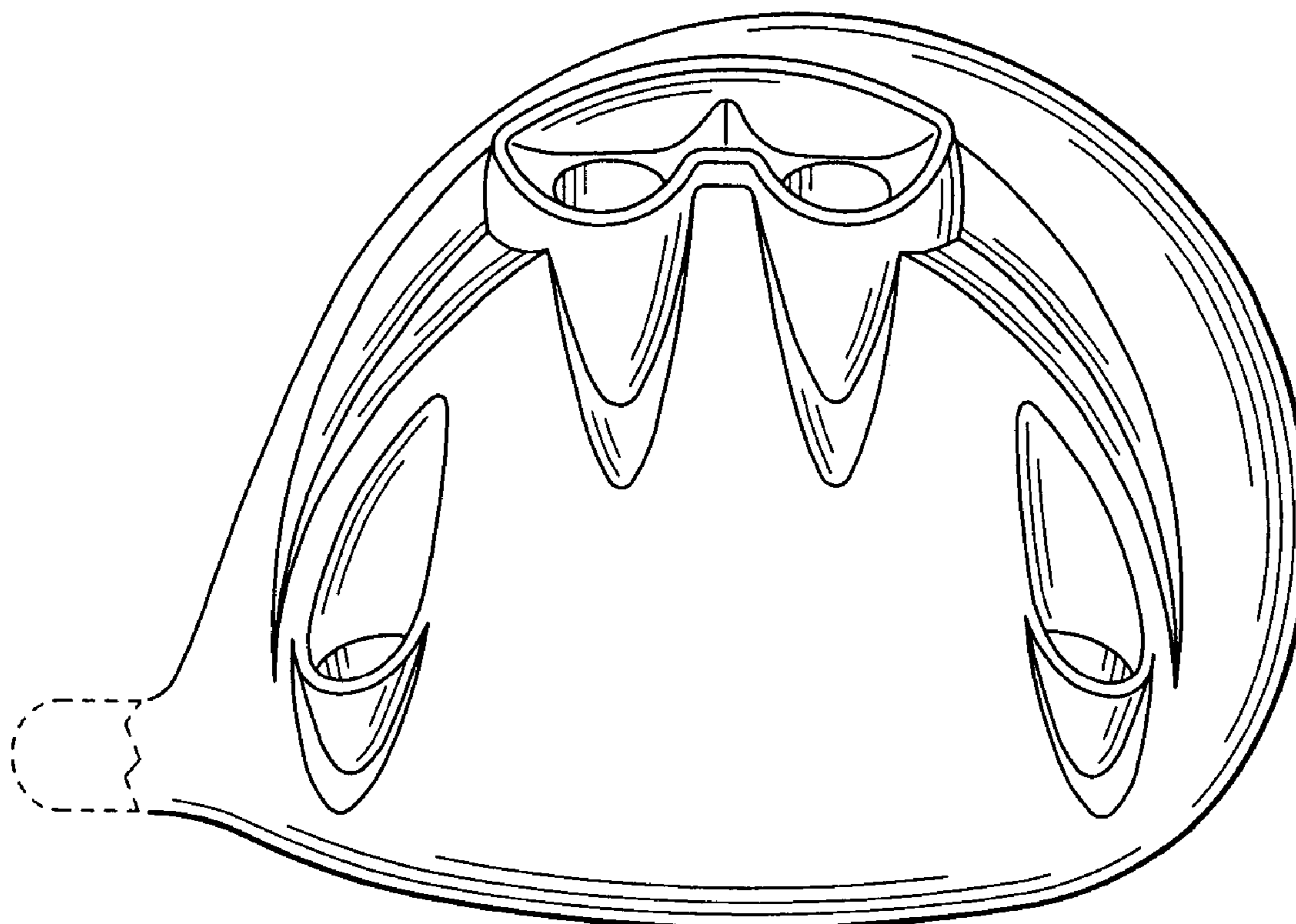

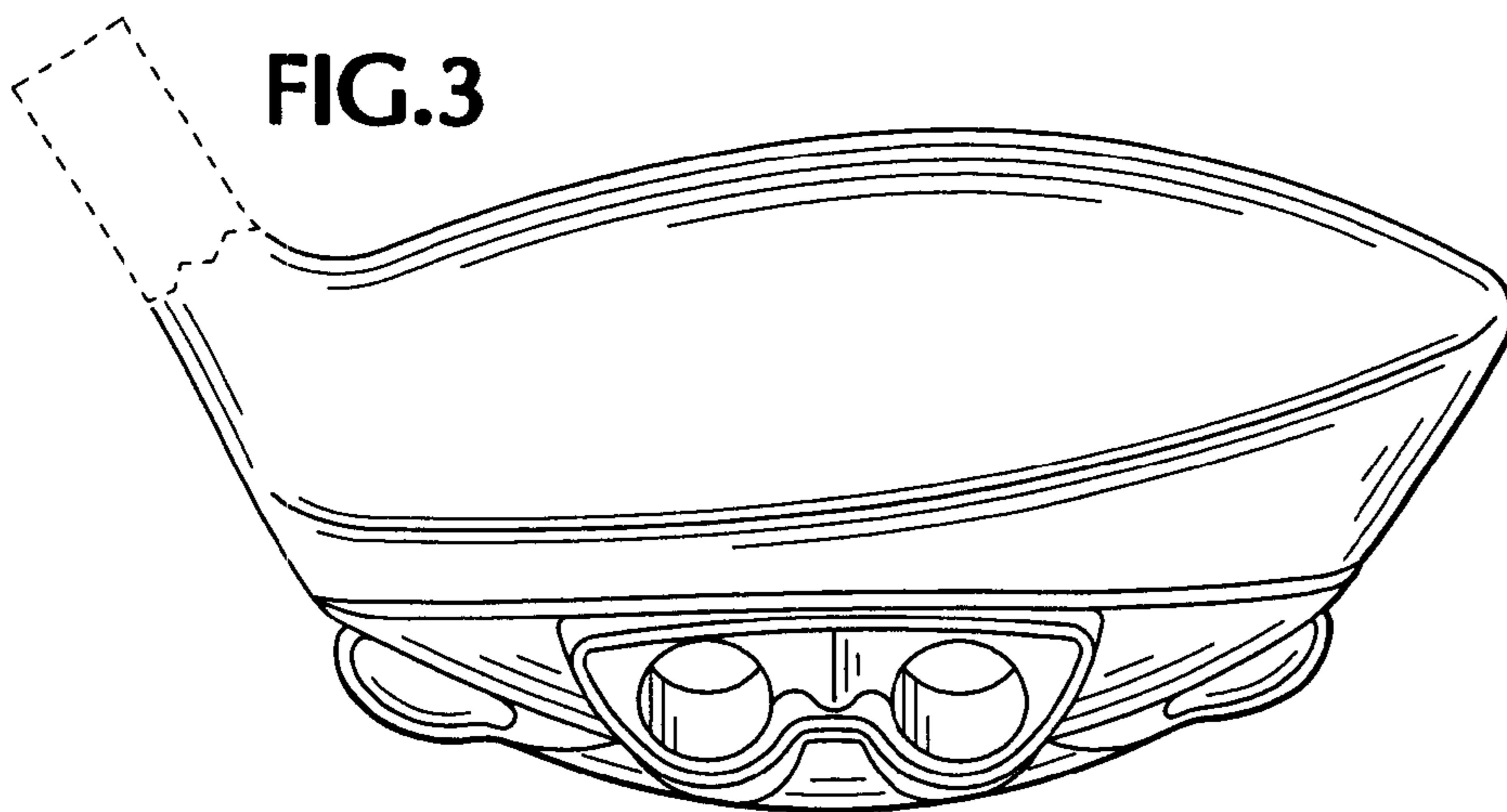
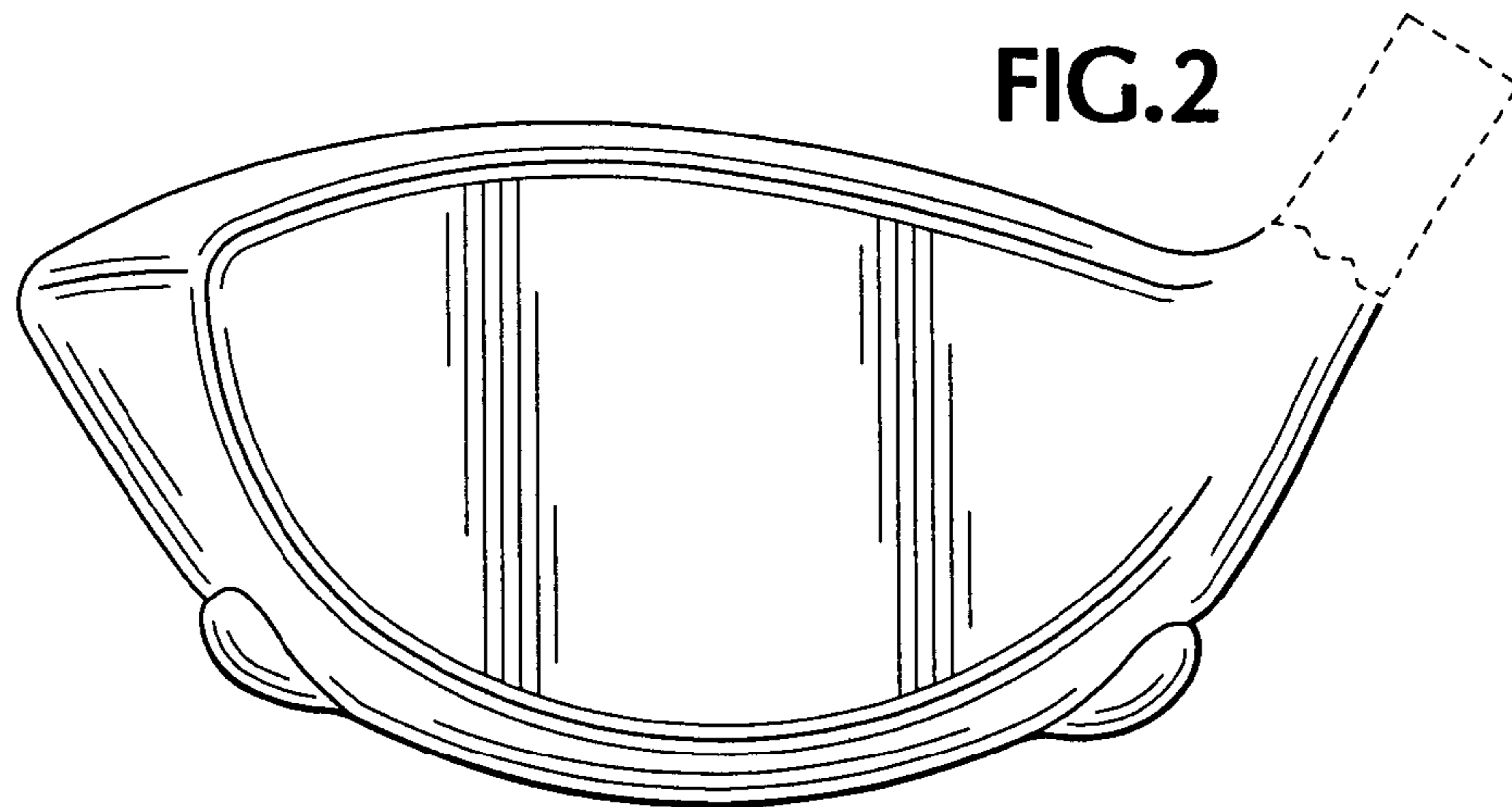
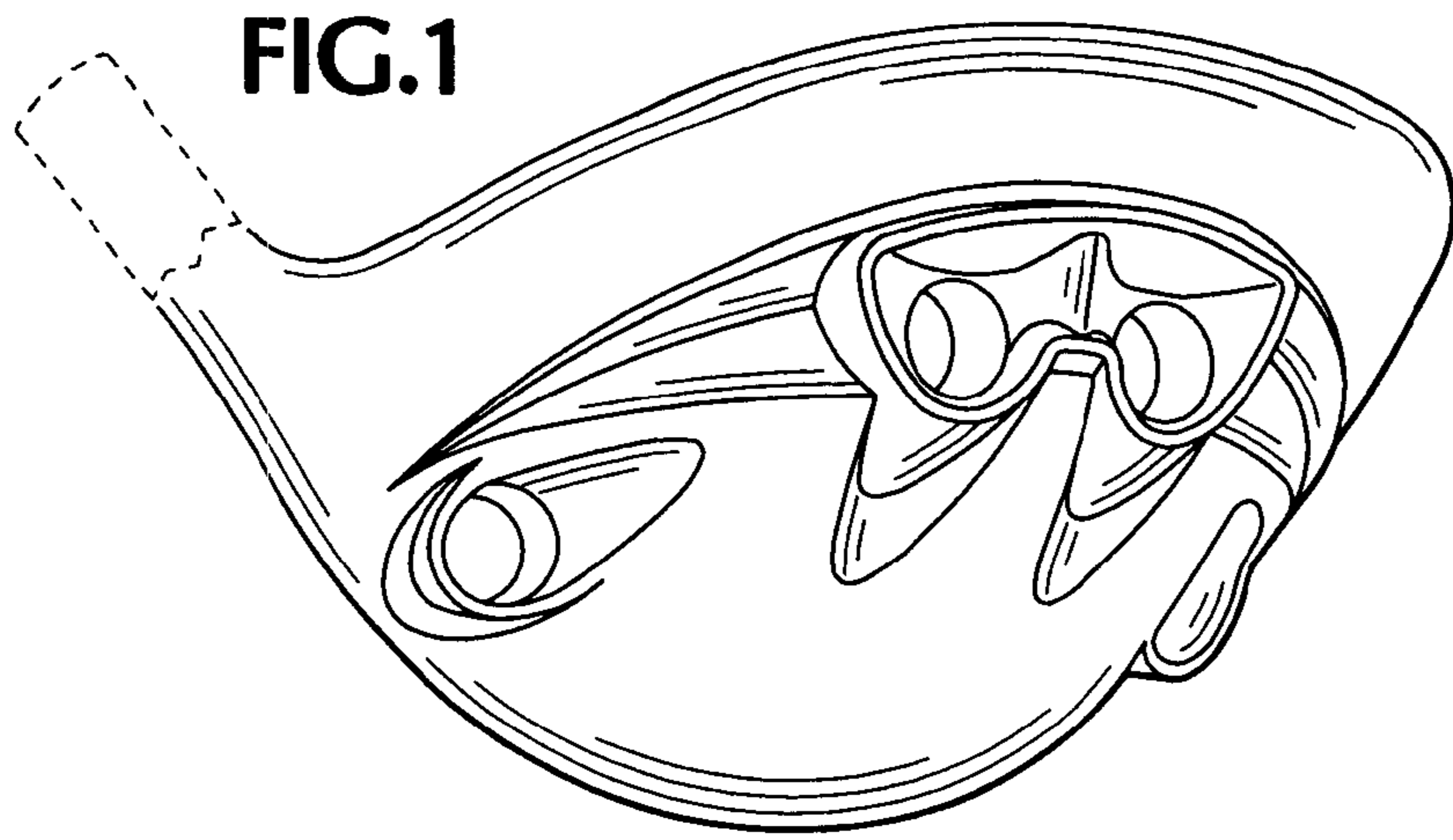

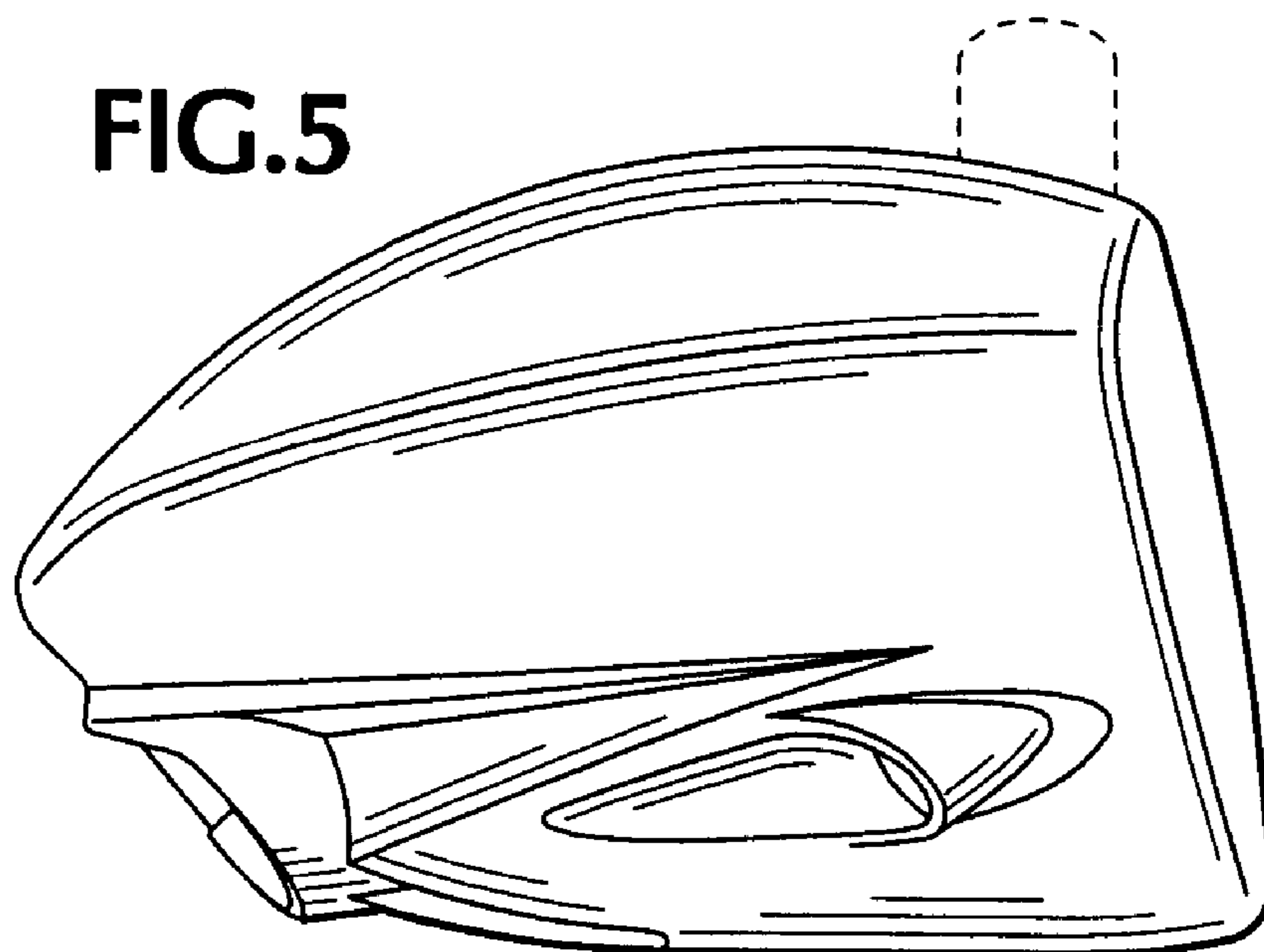
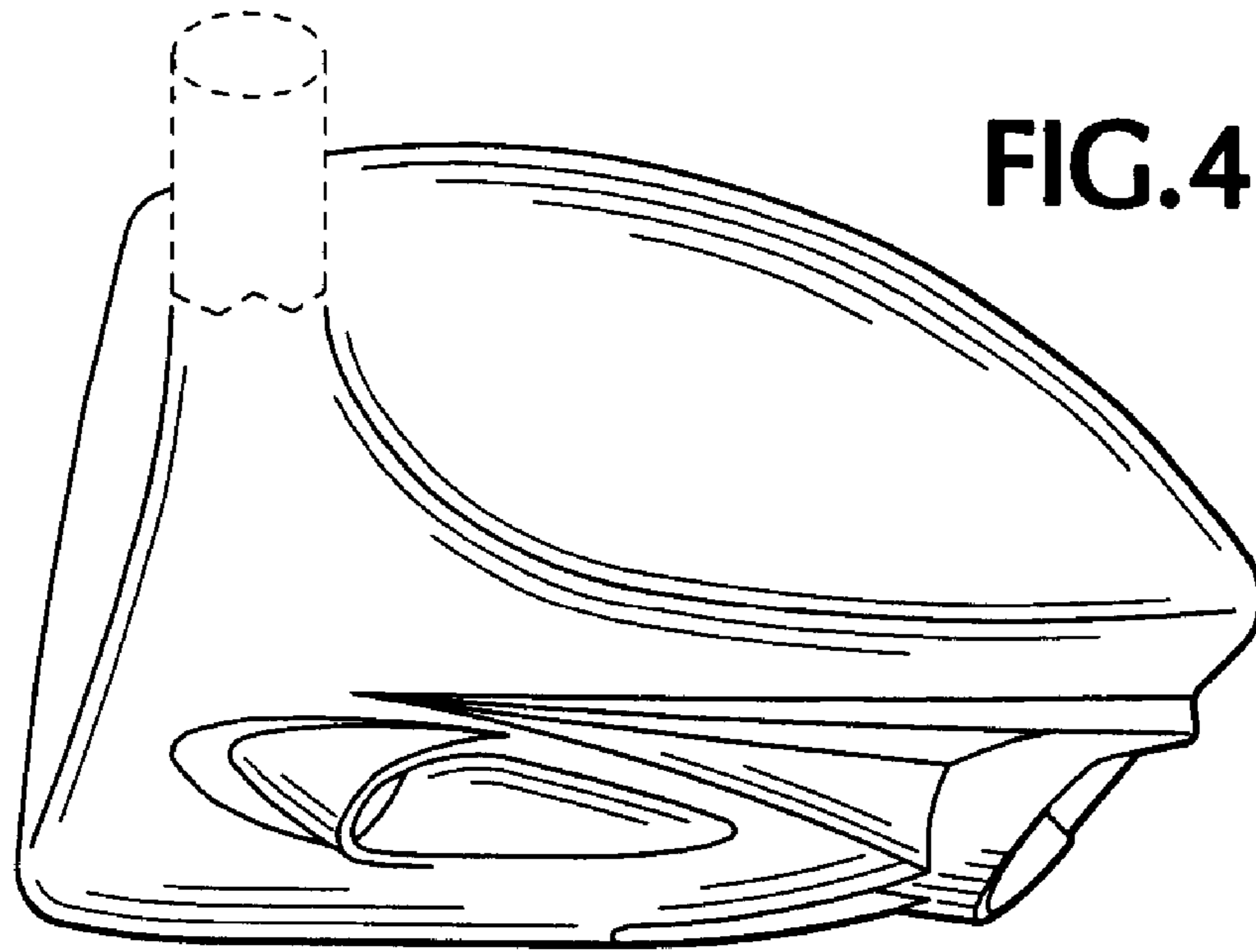

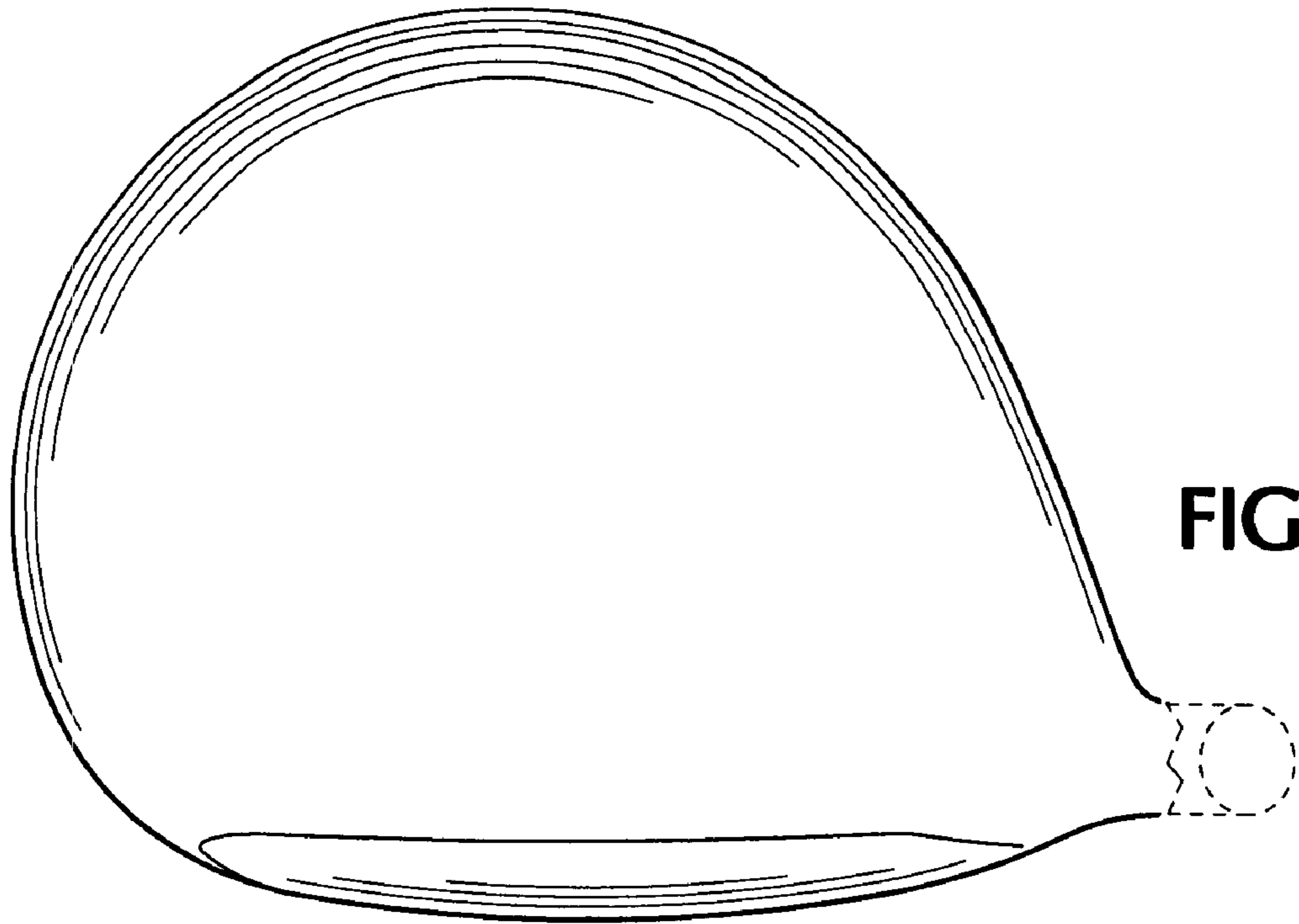

FIG. 6

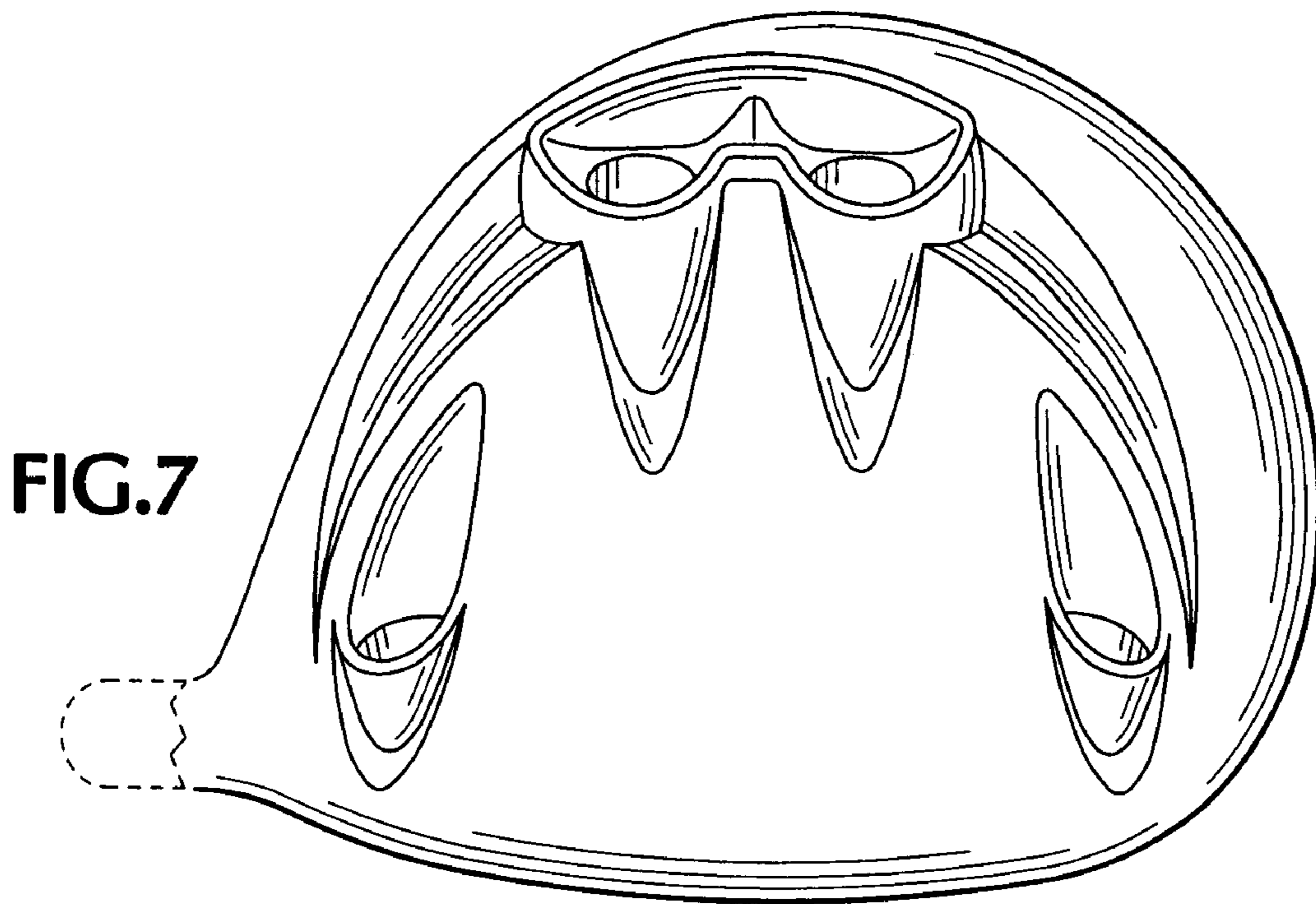

FIG. 7

UNITED STATES PATENT AND TRADEMARK OFFICE
CERTIFICATE OF CORRECTION

PATENT NO. : Des. 534,598 S
APPLICATION NO. : 29/241307
DATED : January 2, 2007
INVENTOR(S) : Barez et al.

Page 1 of 1

It is certified that error appears in the above-identified patent and that said Letters Patent is hereby corrected as shown below:

In the Inventors Section:

First page, inventor --Thomas Olsavsky, Oceanside, California-- should be added.

Signed and Sealed this

Tenth Day of April, 2007

A handwritten signature in black ink on a light gray dotted background. The signature reads "Jon W. Dudas" in a cursive style.

JON W. DUDAS

Director of the United States Patent and Trademark Office