



US00D534597S

(12) **United States Design Patent**  
**Nicolette et al.**

(10) **Patent No.:** **US D534,597 S**  
(45) **Date of Patent:** **\*\* Jan. 2, 2007**

(54) **GOLF IRON HEAD**

(75) Inventors: **Michael R. Nicolette**, Scottsdale, AZ (US); **Bradley D. Schweigert**, Anthem, AZ (US); **Marty R. Jertson**, Phoenix, AZ (US); **John A. Solheim**, Phoenix, AZ (US); **Eric V. Cole**, Phoenix, AZ (US)

(73) Assignee: **Karsten Manufacturing Corporation**, Phoenix, AZ (US)

(\*\*) Term: **14 Years**

(21) Appl. No.: **29/261,459**

(22) Filed: **Jun. 13, 2006**

**Related U.S. Application Data**

(62) Division of application No. 29/230,784, filed on May 25, 2005.

(51) **LOC (8) Cl.** ..... **21-02**

(52) **U.S. Cl.** ..... **D21/749**

(58) **Field of Classification Search** ..... D21/747-751;  
473/324-331, 350  
See application file for complete search history.

(56) **References Cited**

**U.S. PATENT DOCUMENTS**

D228,355 S \* 9/1973 Penna ..... D21/749  
D256,264 S 8/1980 Solheim  
D379,393 S 5/1997 Kubica  
D422,043 S 3/2000 Kubica  
D429,299 S 8/2000 Kubica

D442,659 S \* 5/2001 Kubica et al. .... D21/747  
D443,008 S 5/2001 Kubica et al.  
D468,787 S \* 1/2003 Oosthuizen ..... D21/747  
D469,136 S \* 1/2003 Roberts ..... D21/747  
D470,554 S 2/2003 Truesdale  
D494,648 S 8/2004 Schweigert  
D500,350 S 12/2004 Schweigert  
D500,351 S \* 12/2004 Schweigert et al. .... D21/747  
D502,237 S 2/2005 Schweigert  
D502,975 S 3/2005 Schweigert  
D504,925 S \* 5/2005 Schweigert et al. .... D21/748  
D505,171 S \* 5/2005 Schweigert et al. .... D21/749  
D508,099 S 8/2005 Schweigert  
D514,183 S \* 1/2006 Schweigert et al. .... D21/748

\* cited by examiner

*Primary Examiner*—Mitchell Siegel

(74) *Attorney, Agent, or Firm*—Darrell F. Marquette

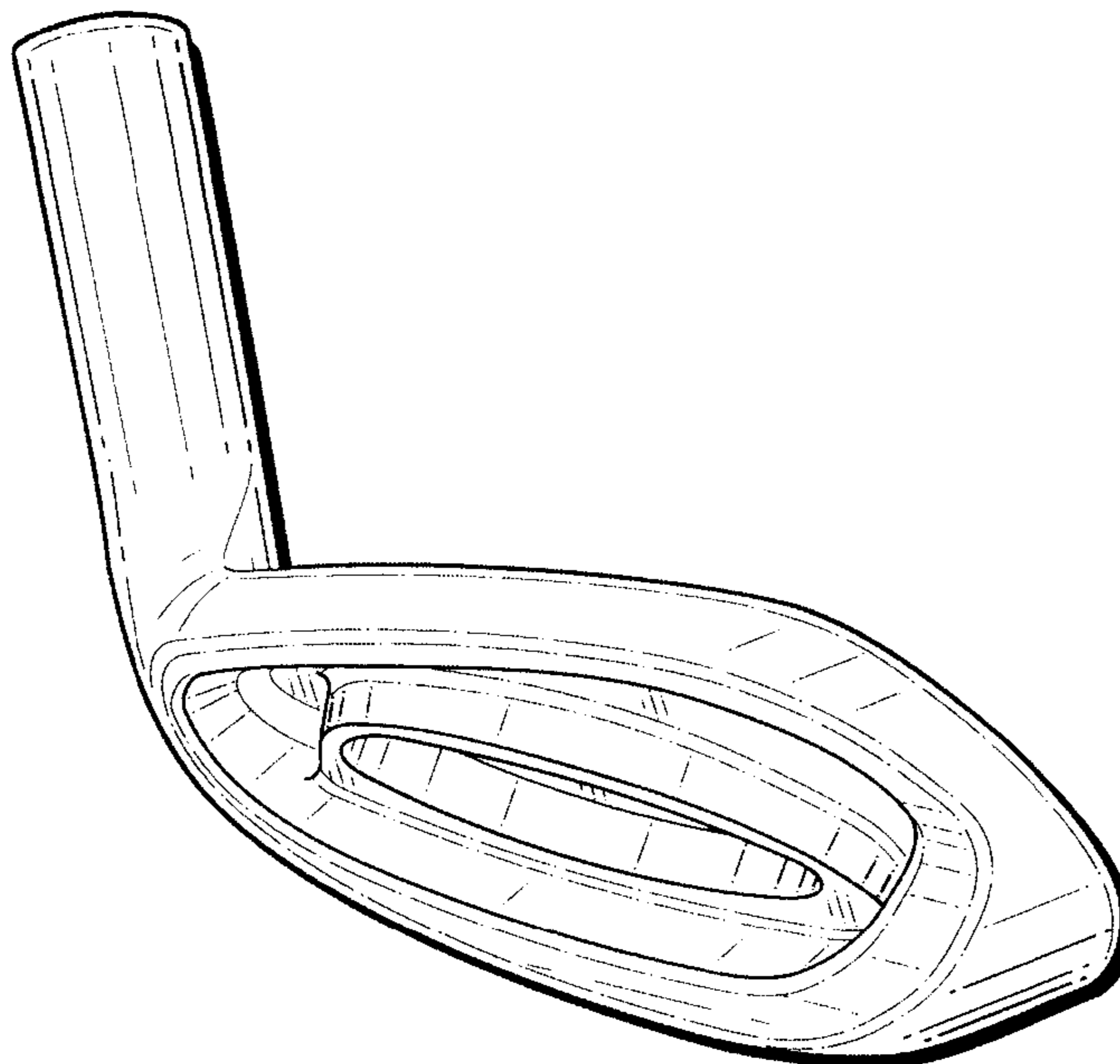
(57) **CLAIM**

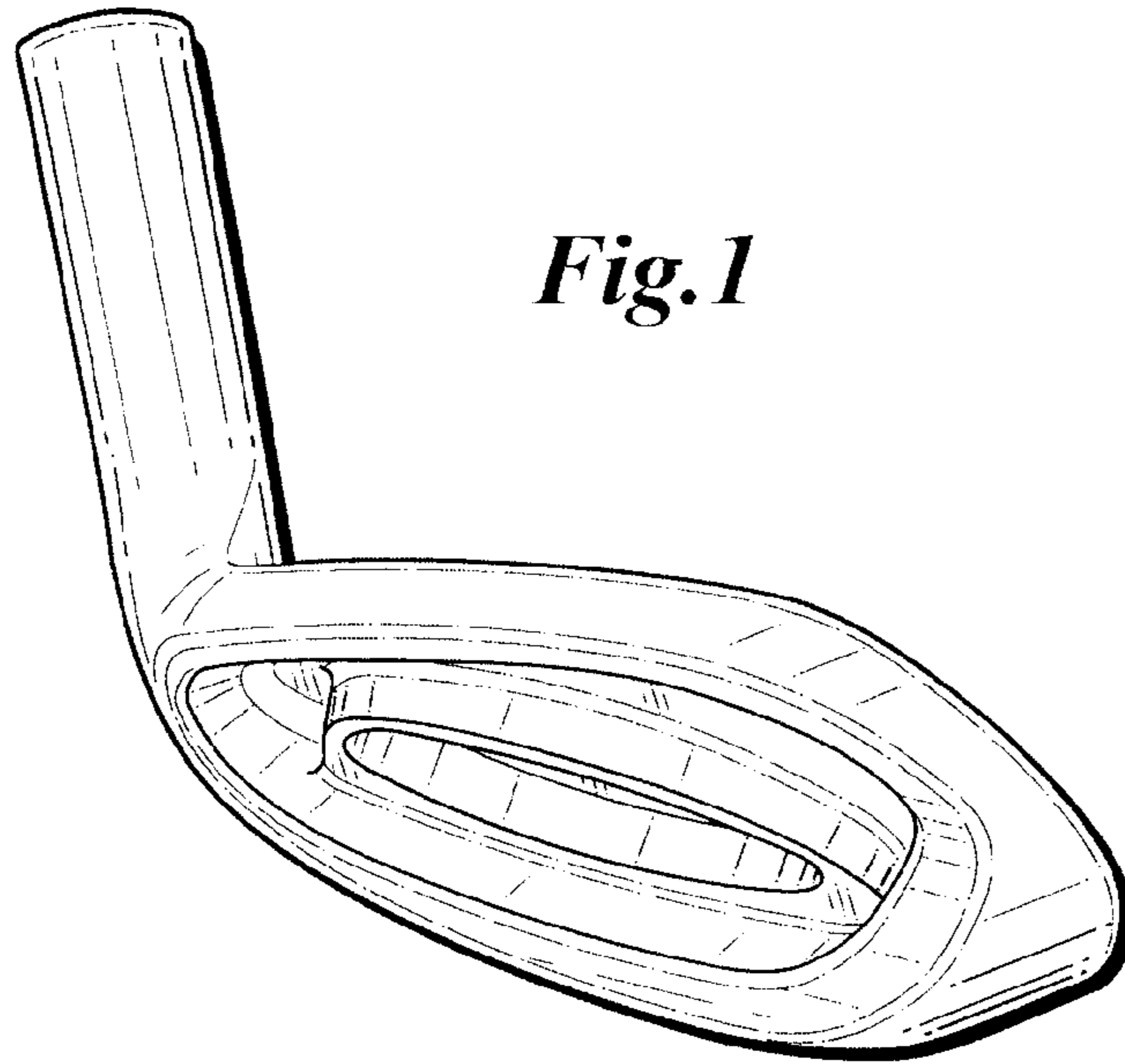
The ornamental design for a golf iron head, as shown and described.

**DESCRIPTION**

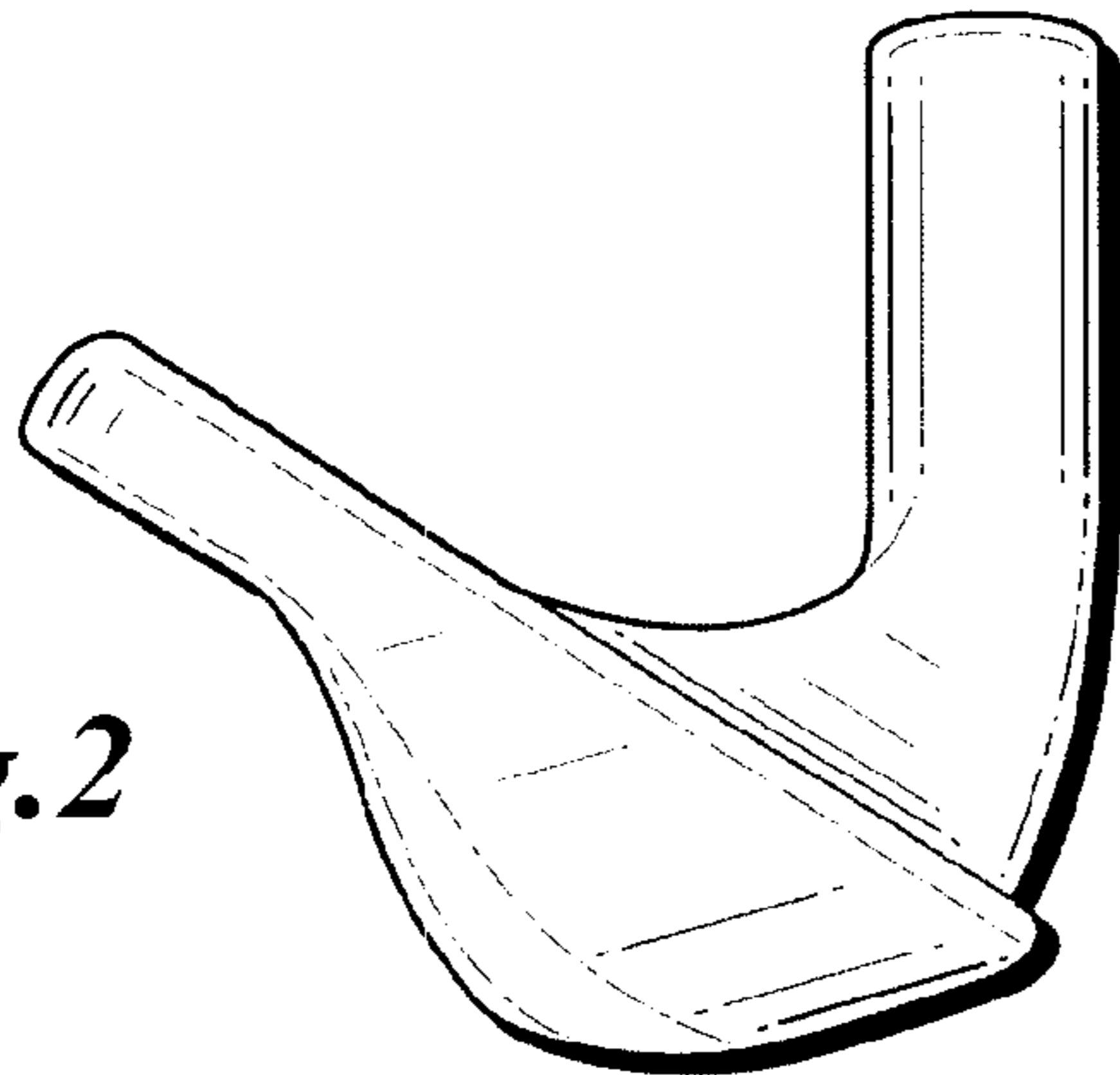
FIG. 1 is a perspective view of a golf iron head with a high loft angle such as a wedge showing our new design; FIG. 2 is a toe end view of the golf iron head of FIG. 1; FIG. 3 is a heel end view of the golf iron head of FIG. 1; FIG. 4 is a top view of the golf iron head of FIG. 1; FIG. 5 is a bottom view of the golf iron head of FIG. 1; FIG. 6 is a front elevational view of the golf iron head of FIG. 1; and, FIG. 7 is a rear elevational view of the golf iron head of FIG. 1.

**1 Claim, 2 Drawing Sheets**

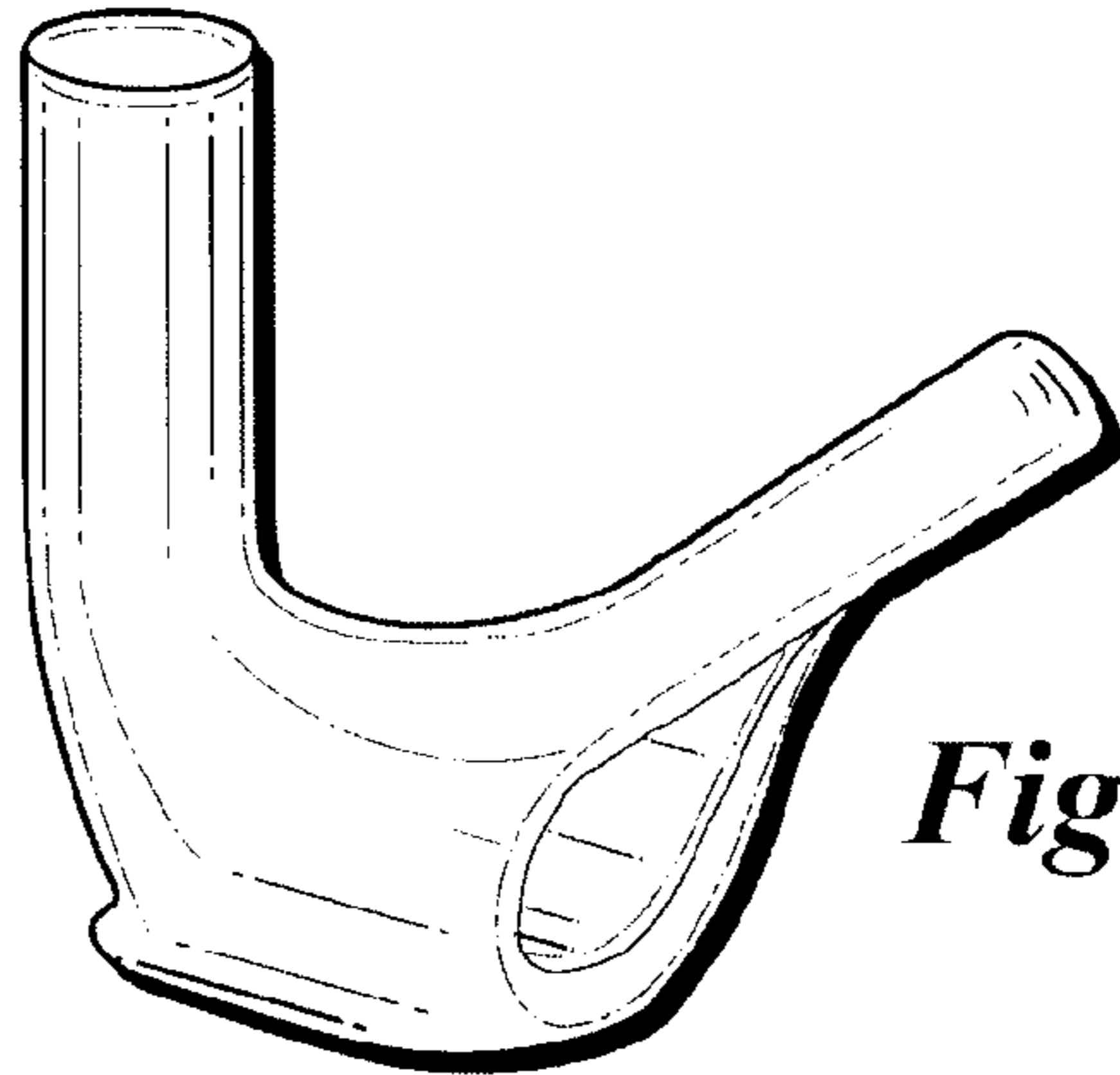




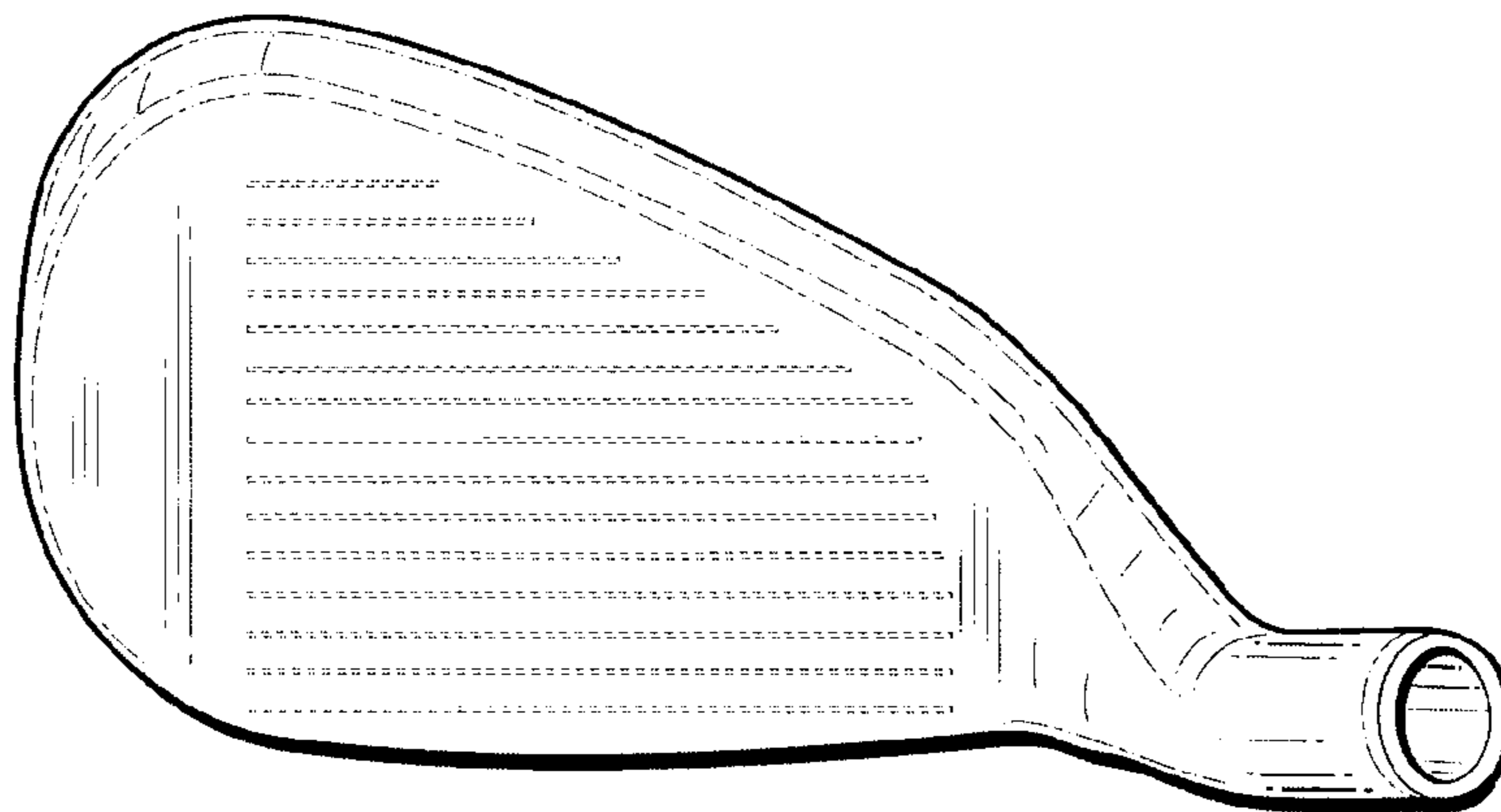
*Fig. 1*



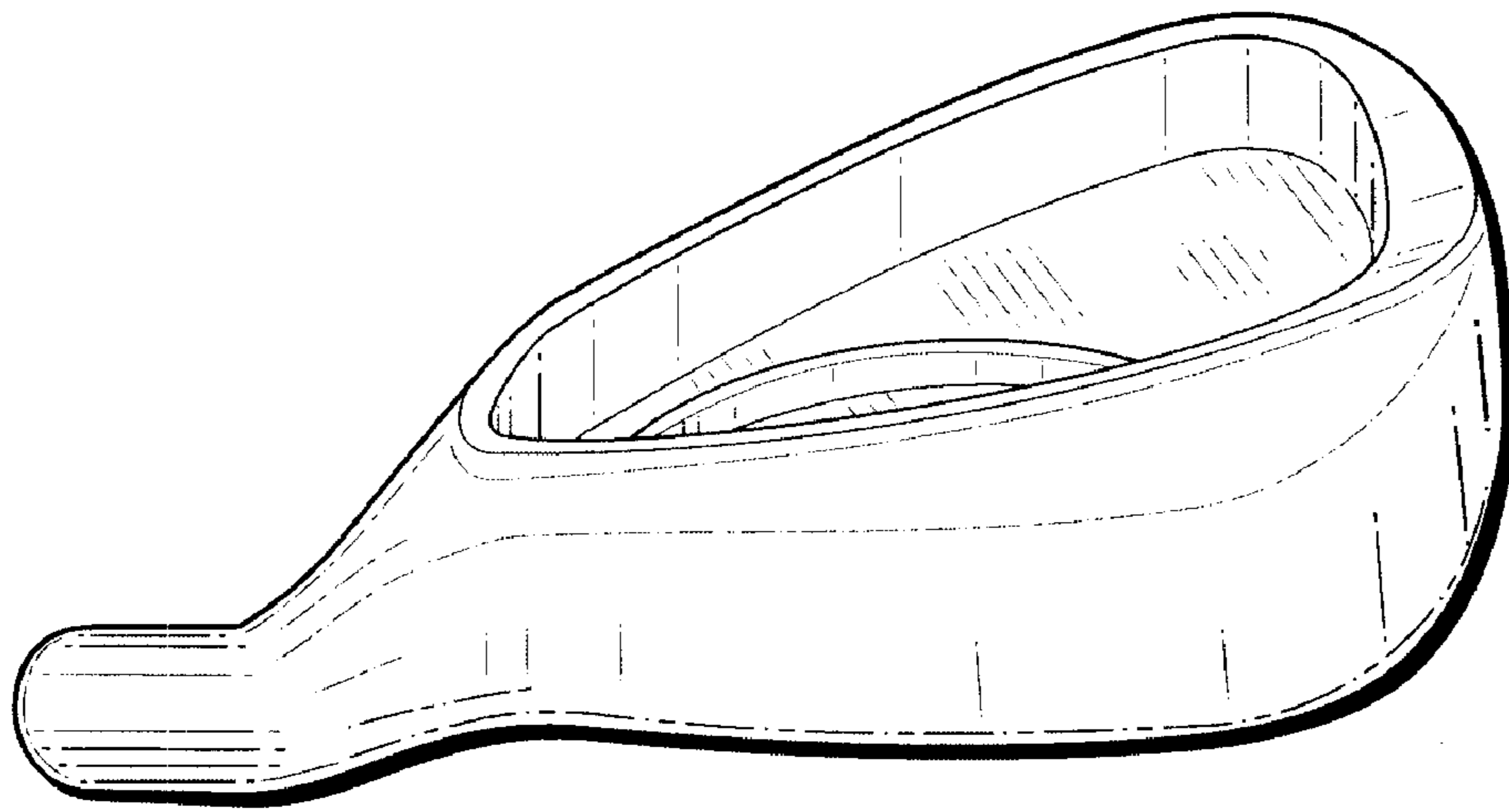
*Fig. 2*



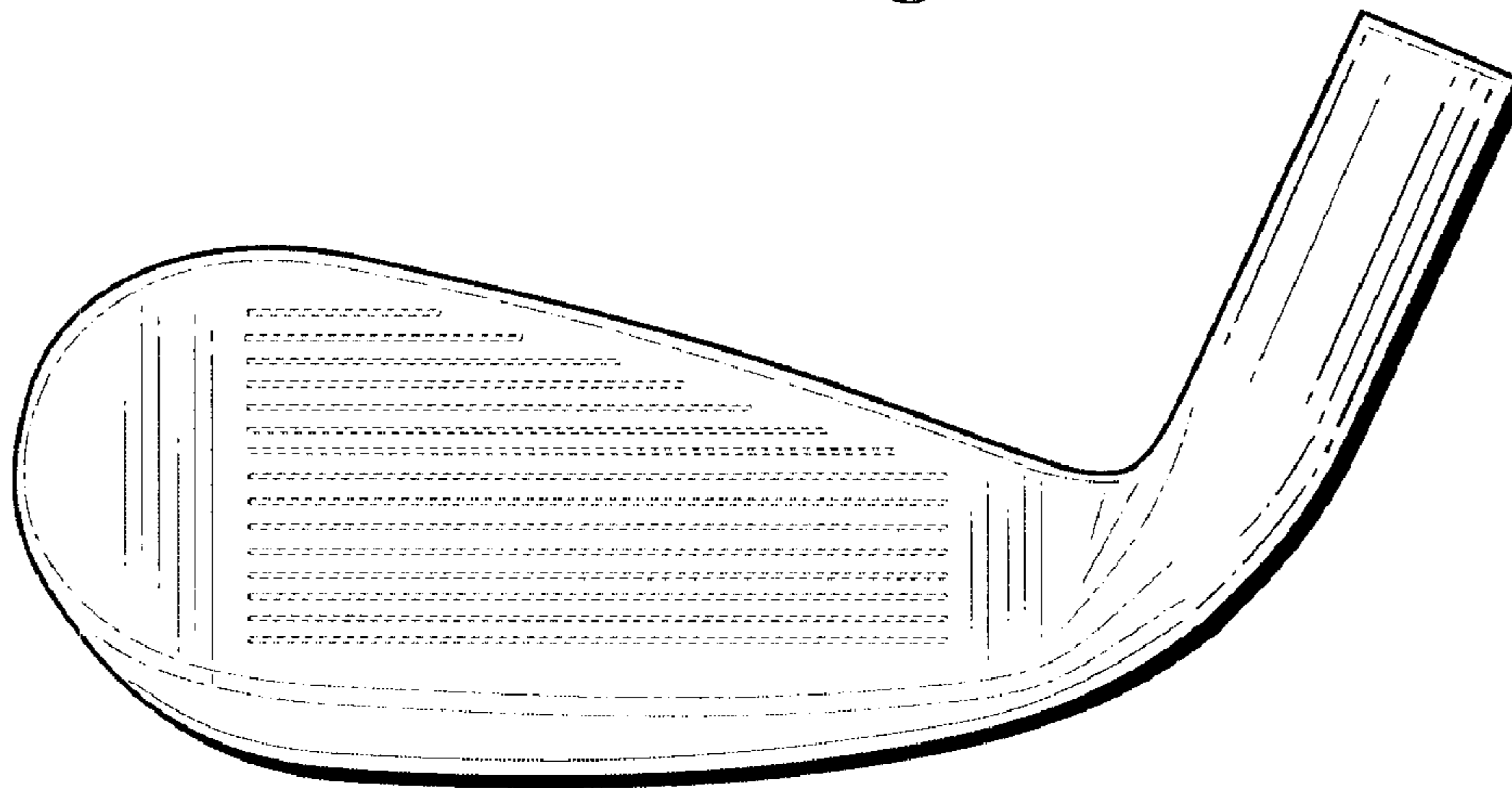
*Fig. 3*



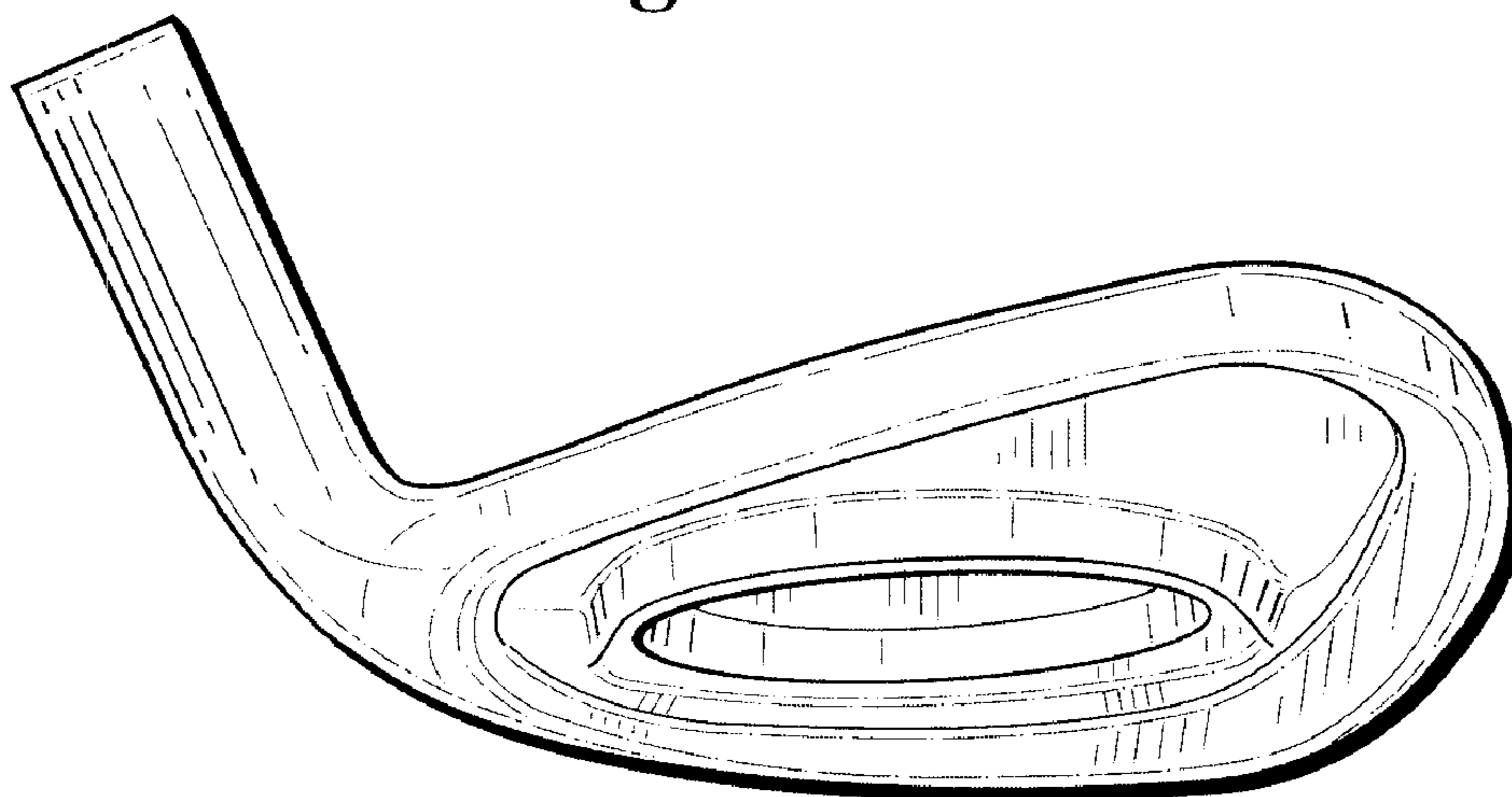
*Fig. 4*



*Fig. 5*



*Fig. 6*



*Fig. 7*