



US00D534531S

(12) **United States Design Patent**  
**Ogasawara**

(10) **Patent No.:** **US D534,531 S**

(45) **Date of Patent:** **\*\* Jan. 2, 2007**

(54) **COMPUTER**

(75) Inventor: **Shinichi Ogasawara**, Tokyo (JP)

(73) Assignee: **Sony Corporation**, Tokyo (JP)

(\*\*) Term: **14 Years**

(21) Appl. No.: **29/242,108**

(22) Filed: **Nov. 7, 2005**

(30) **Foreign Application Priority Data**

Jun. 24, 2005 (JP) ..... D2005-018491

(51) **LOC (8) Cl.** ..... **14-02**

(52) **U.S. Cl.** ..... **D14/318**

(58) **Field of Classification Search** ..... D14/315-323;  
D18/1, 2, 7, 11; 235/145 A, 145 R; 341/22,  
341/23; 345/156, 168, 169, 172, 173, 87;  
361/680-686, 690-695; 400/486, 489

See application file for complete search history.

(56) **References Cited**

**U.S. PATENT DOCUMENTS**

D415,474 S 10/1999 Goto  
D422,569 S 4/2000 Ogasawara  
6,067,224 A \* 5/2000 Nobuchi ..... 361/683  
D479,841 S \* 9/2003 Tago et al. .... D14/323  
D495,691 S \* 9/2004 Takada et al. .... D14/318  
D510,737 S 10/2005 Yokota  
2002/0033795 A1 \* 3/2002 Shahoian et al. .... 345/156

2005/0017947 A1 \* 1/2005 Shahoian et al. .... 345/156  
2005/0018396 A1 \* 1/2005 Nakajima et al. .... 361/683  
2005/0041378 A1 \* 2/2005 Hamada et al. .... 361/680  
2005/0088405 A1 \* 4/2005 Chu et al. .... 345/156

**FOREIGN PATENT DOCUMENTS**

JP D1098343 S 1/2001

**OTHER PUBLICATIONS**

Web page "VGN-T50B" <http://www.vaio.sony.co.jp/Products/VGN-T50B/feat1.html>, 2 sheets, Sony (Sep. 2005).

\* cited by examiner

*Primary Examiner*—Freda S. Nunn

(74) *Attorney, Agent, or Firm*—Rader, Fishman & Grauer PLLC

(57) **CLAIM**

The ornamental design for a computer, as shown.

**DESCRIPTION**

FIG. 1 is a perspective view of a computer showing my new design;

FIG. 2 is a front elevational view thereof;

FIG. 3 is a rear elevational view thereof;

FIG. 4 is a left side elevational view thereof;

FIG. 5 is a right side elevational view thereof;

FIG. 6 is a top plan view thereof; and,

FIG. 7 is a bottom plan view thereof.

**1 Claim, 7 Drawing Sheets**

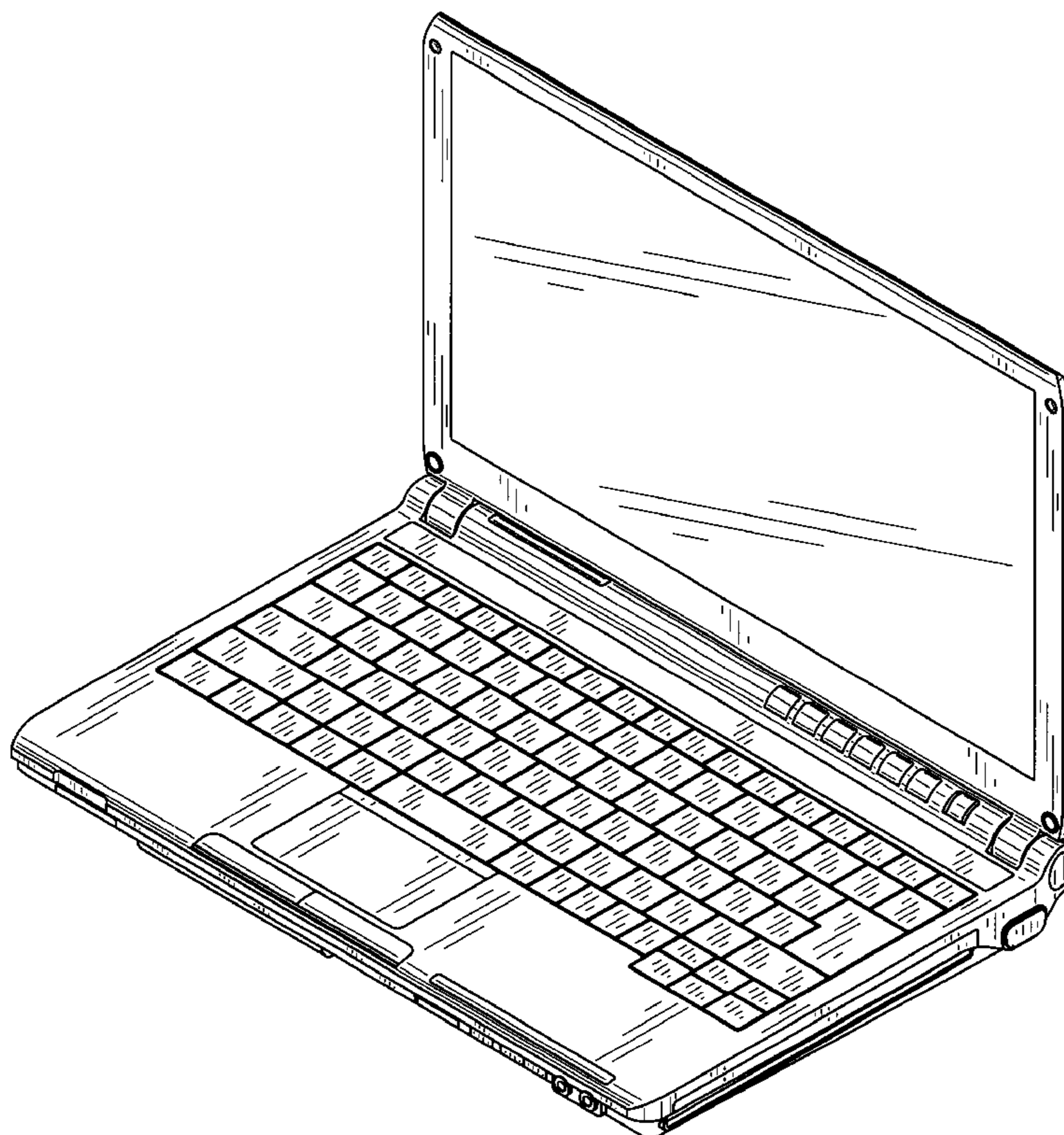

Fig.1

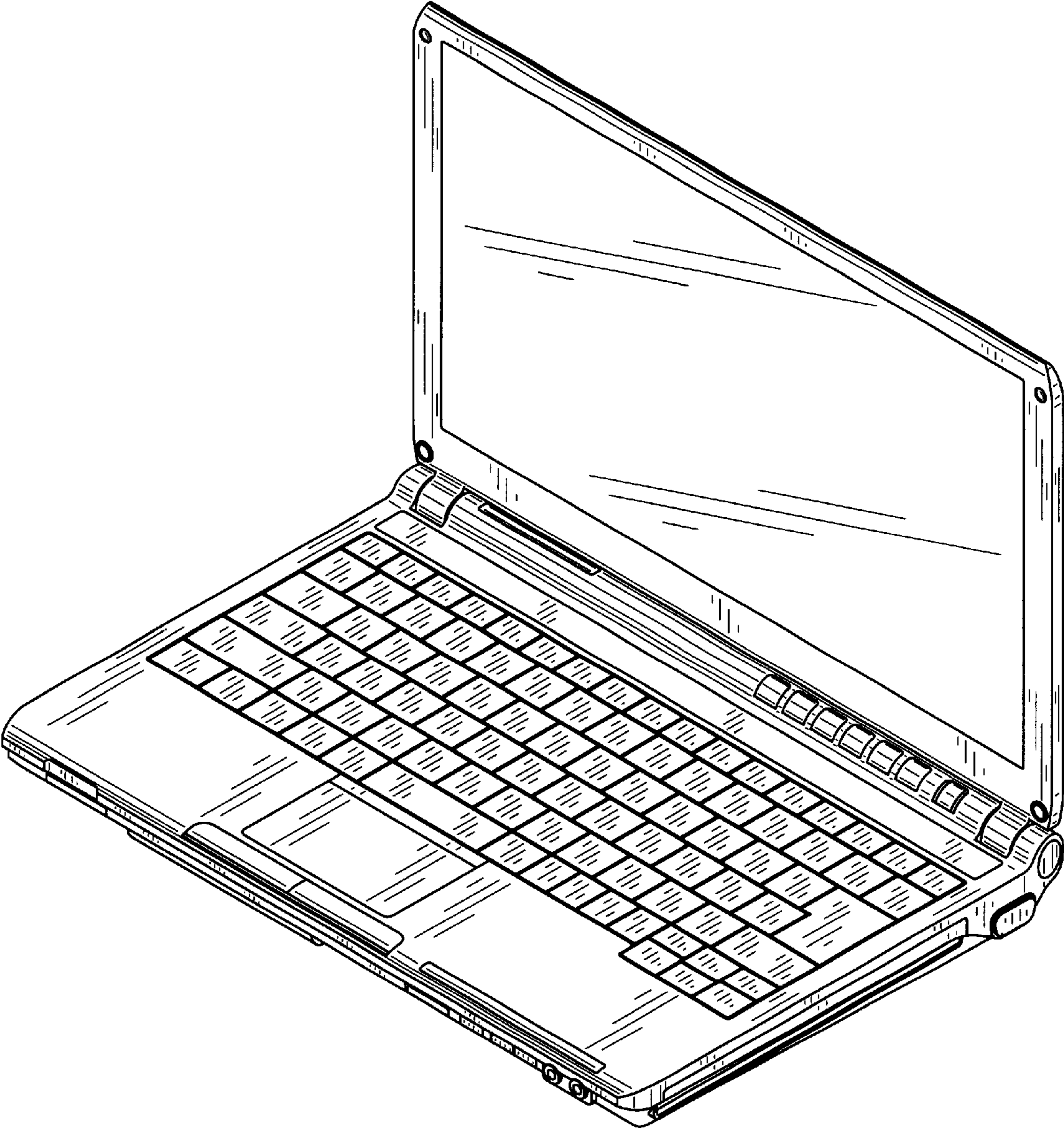

Fig.2

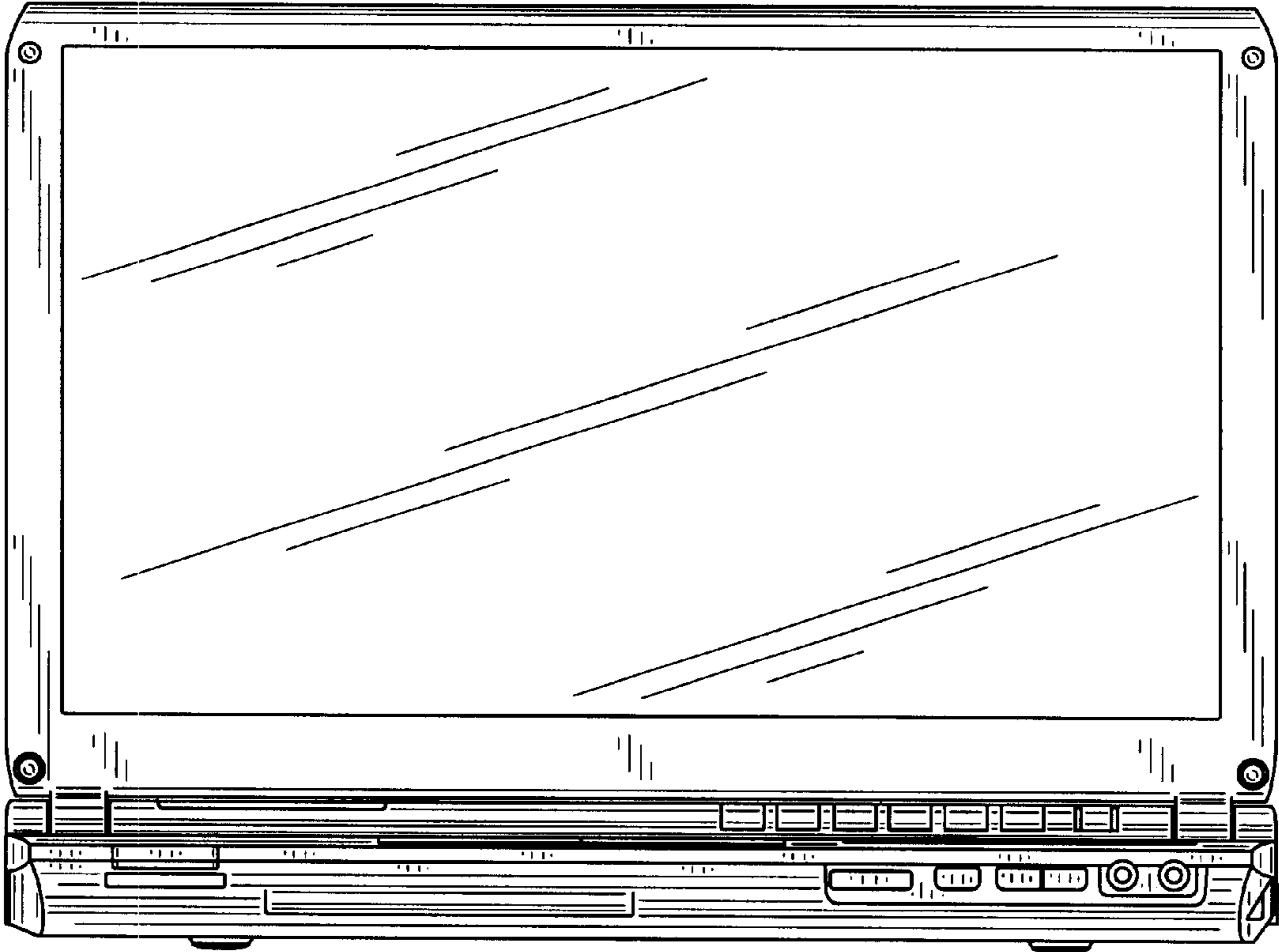

Fig.3

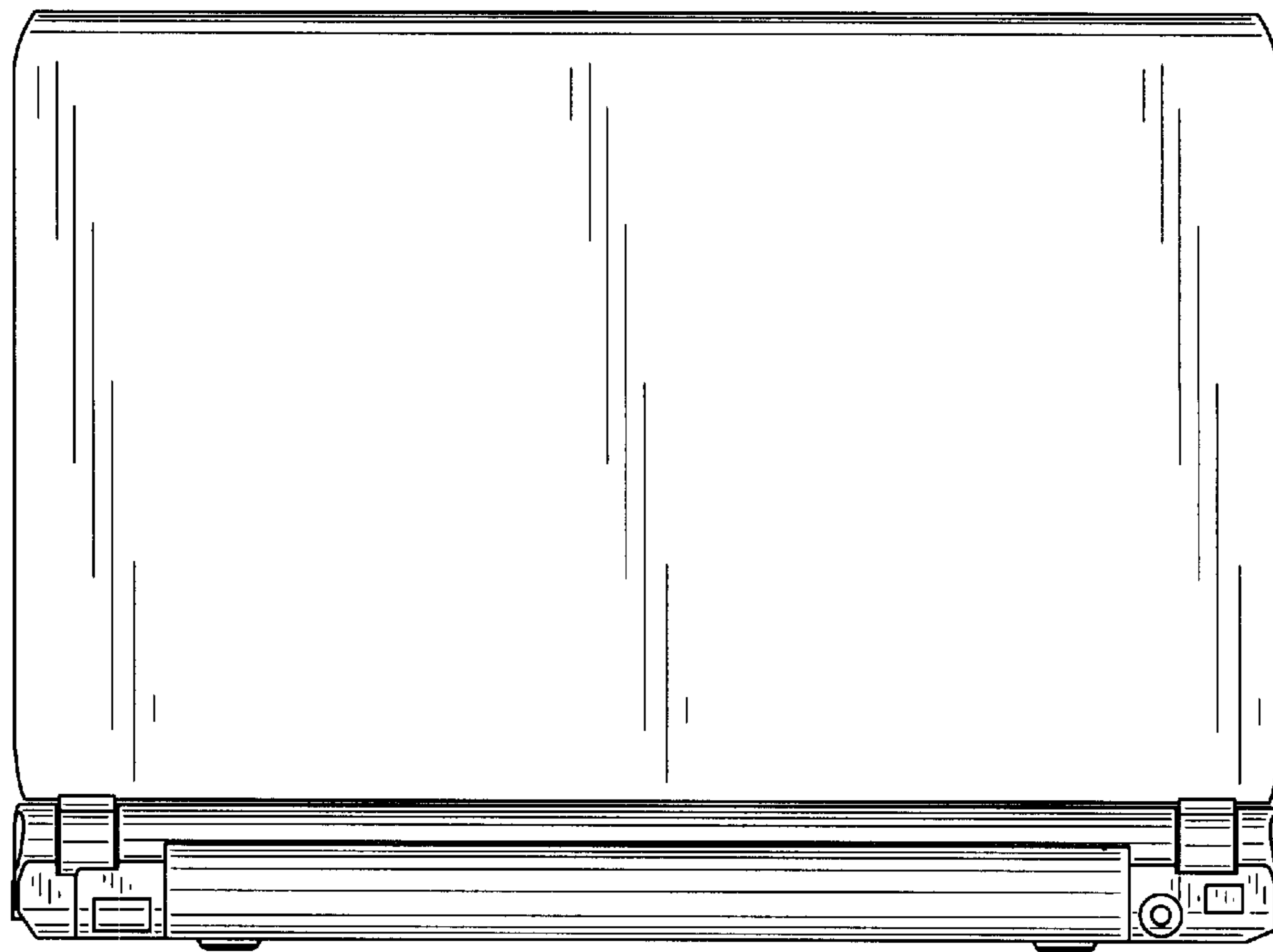

Fig.4

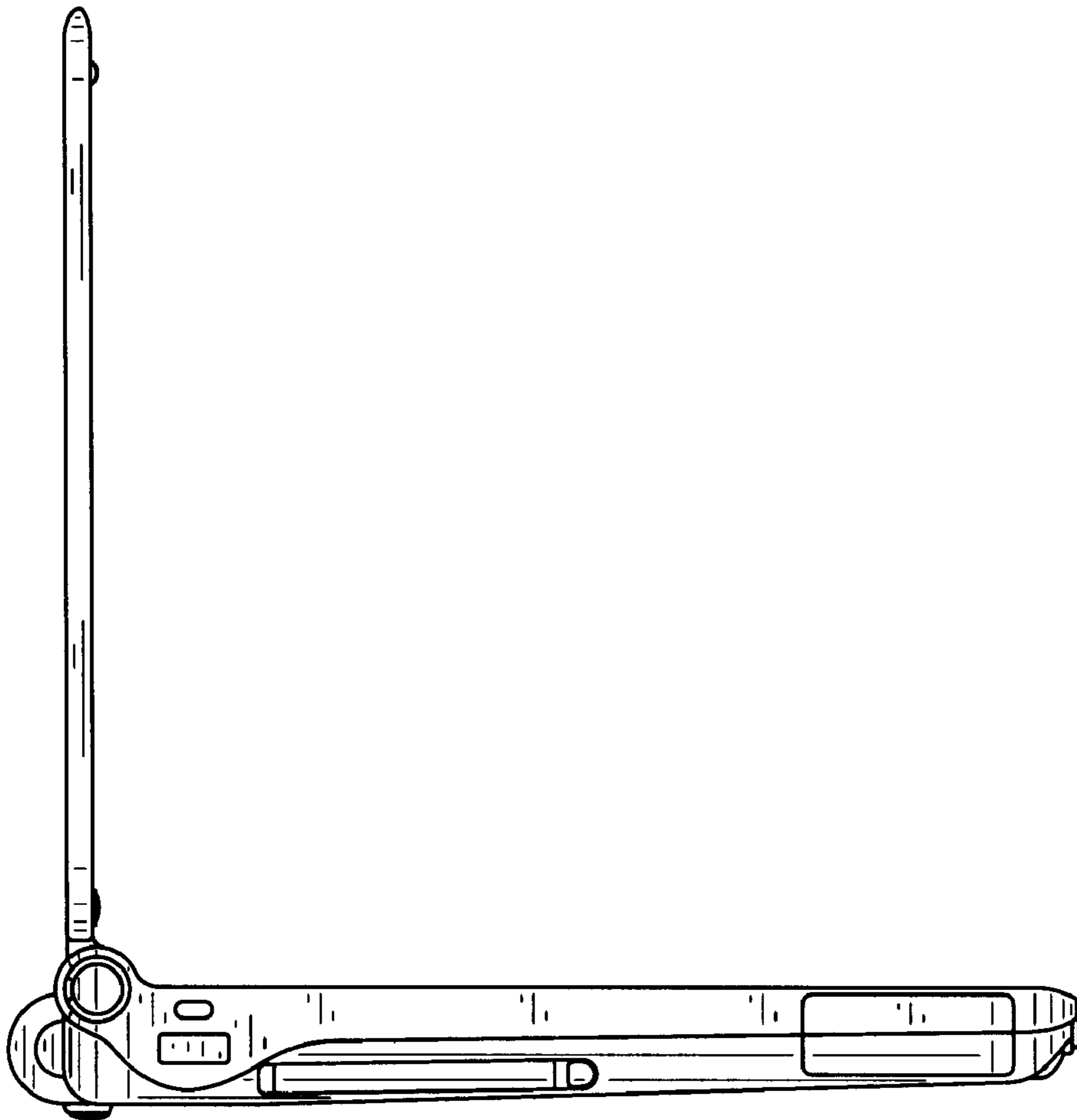

Fig.5

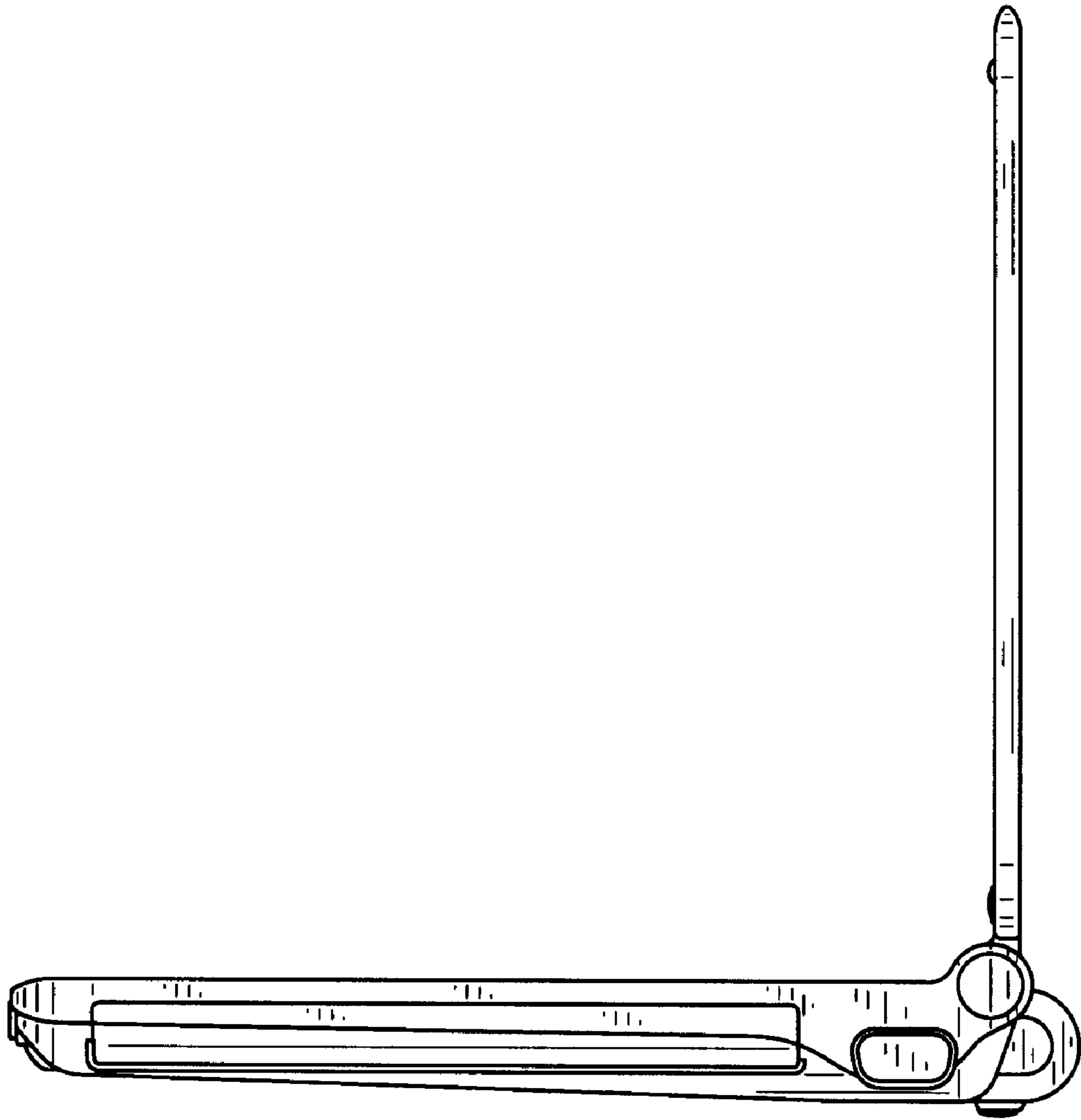

Fig.6

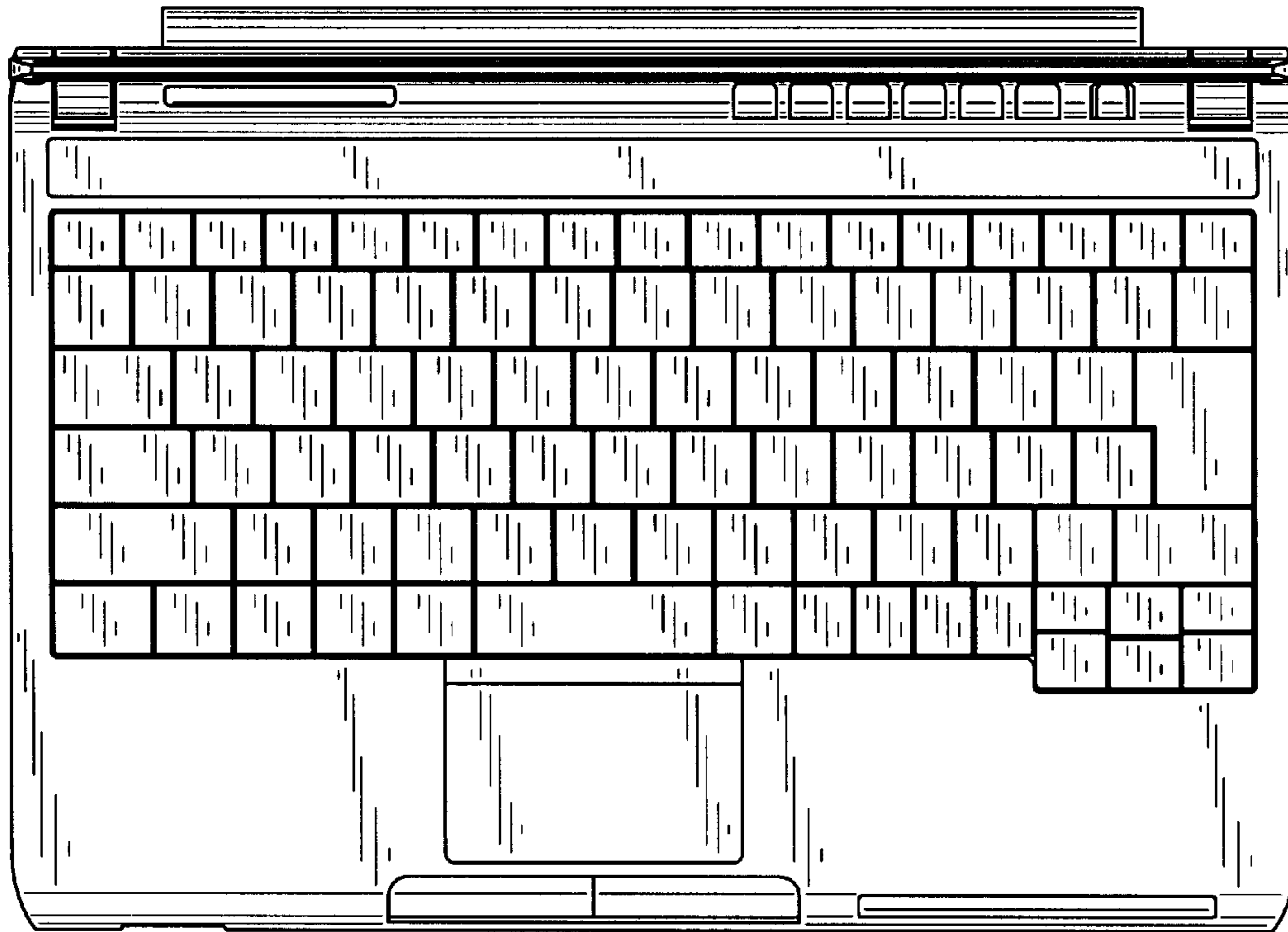

Fig.7

