



US00D534255S

(12) **United States Design Patent** (10) **Patent No.:** **US D534,255 S**
Chan (45) **Date of Patent:** **** Dec. 26, 2006**

(54) **ANCHOR FOR A SHOWER BAR**

D484,226 S * 12/2003 Cropelli D23/304

(75) Inventor: **Wai Man Chan**, Tsuen King Circuit (HK)

OTHER PUBLICATIONS

Shower bar and sprayer, item #S-299 CH, www.tubz.com, Sep 7, 2005.*

(73) Assignee: **Jing Mei Industrial Holding Limited**, Rarotonga (CK)

* cited by examiner

(**) Term: **14 Years**

Primary Examiner—Robert A. Delehanty
(74) *Attorney, Agent, or Firm*—Norris McLaughlin & Marcus PA

(21) Appl. No.: **29/231,581**

(57) **CLAIM**

(22) Filed: **Jun. 7, 2005**

The ornamental design for an anchor for a shower bar, as shown and described.

Related U.S. Application Data

DESCRIPTION

(62) Division of application No. 29/222,162, filed on Jan. 26, 2005.

(51) **LOC (8) Cl.** **23-02**

FIG. 1 is a perspective view of the front of the anchor for a shower bar;

(52) **U.S. Cl.** **D23/304**

FIG. 2 is a plan view of the top thereof;

(58) **Field of Classification Search** D23/270-271,

FIG. 3 is an elevation view of the front thereof;

D23/275, 283, 303-304, 213, 266, 228-229;

FIG. 4 is an elevation view of the back thereof;

4/546, 552, 605, 596-597, 615, 617, 601;

FIG. 5 is an elevation view of a side thereof;

D8/354-356, 373; 248/229.1; D6/546-550

FIG. 6 is a plan view of the bottom thereof; and,

See application file for complete search history.

FIG. 7 is a perspective view of the anchor shown on a reduced scale in condition of use with a shower bar and like anchor.

(56) **References Cited**

The broken line portion showing the shower bar and bracket in FIG. 7 is for illustrative purposes only and forms no part of the claimed design.

U.S. PATENT DOCUMENTS

D131,506 S * 3/1942 Dreyfuss D6/549
2,576,873 A * 11/1951 Zelov D6/546
D440,864 S * 4/2001 Cropelli D23/304

1 Claim, 2 Drawing Sheets

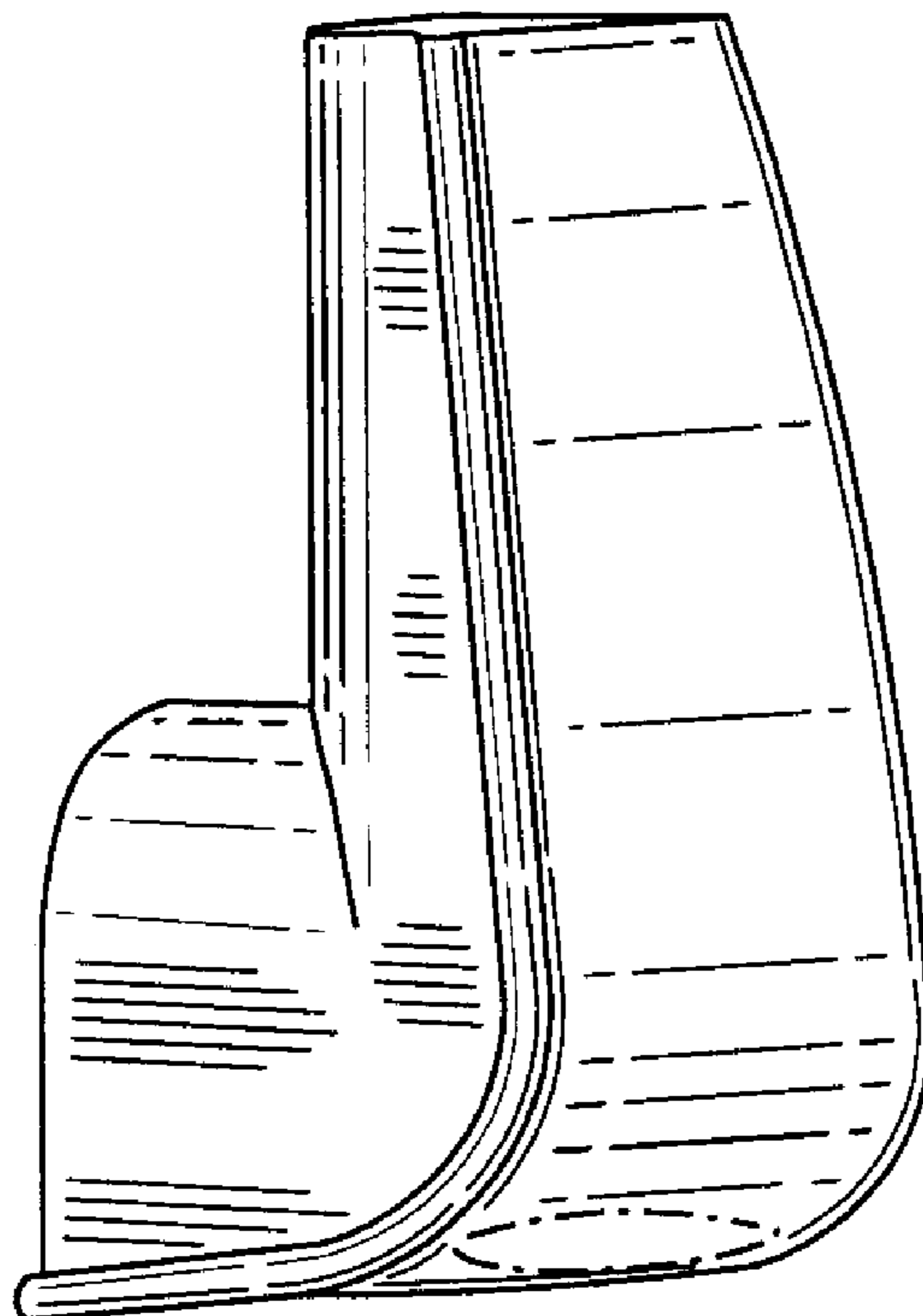

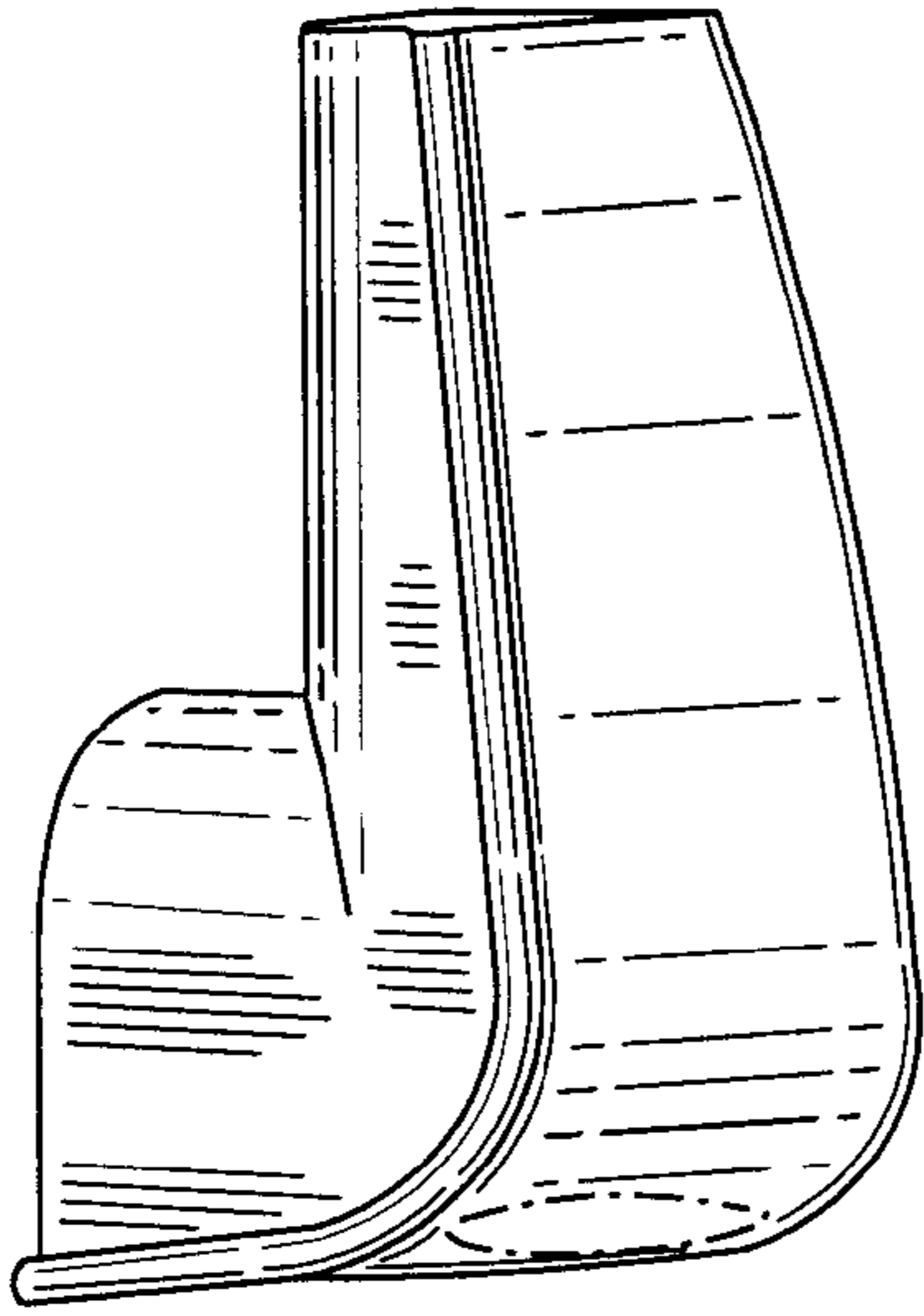

FIG. 1

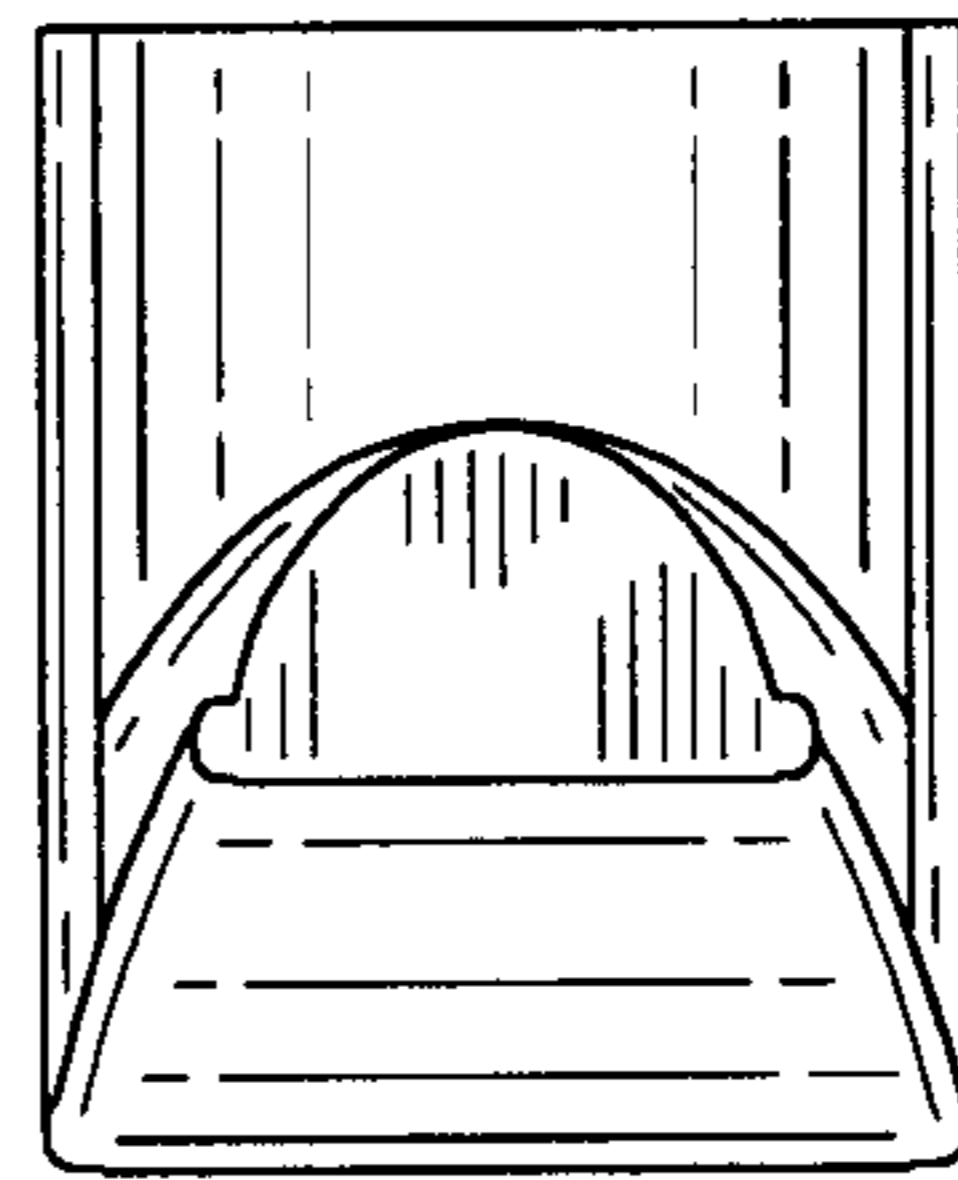

FIG. 2

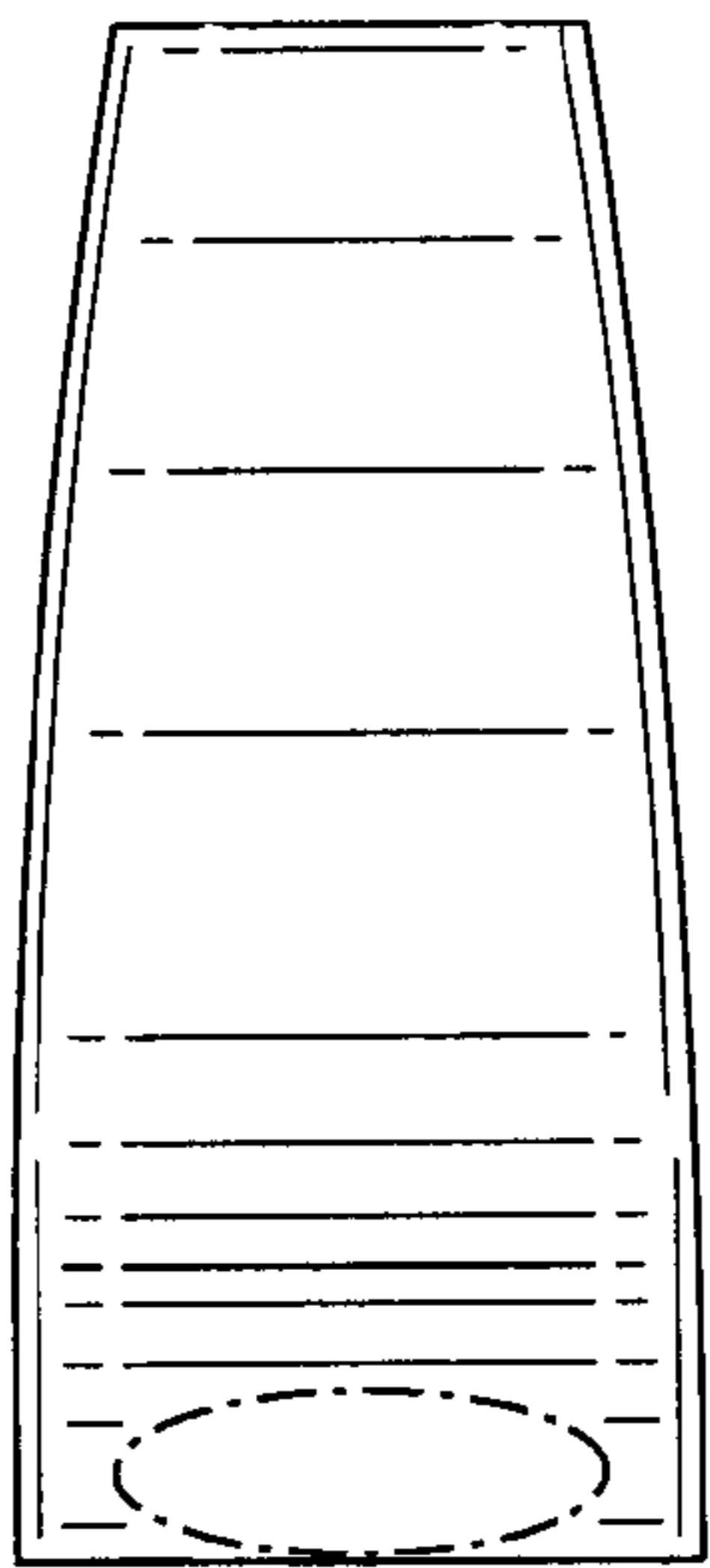

FIG. 3

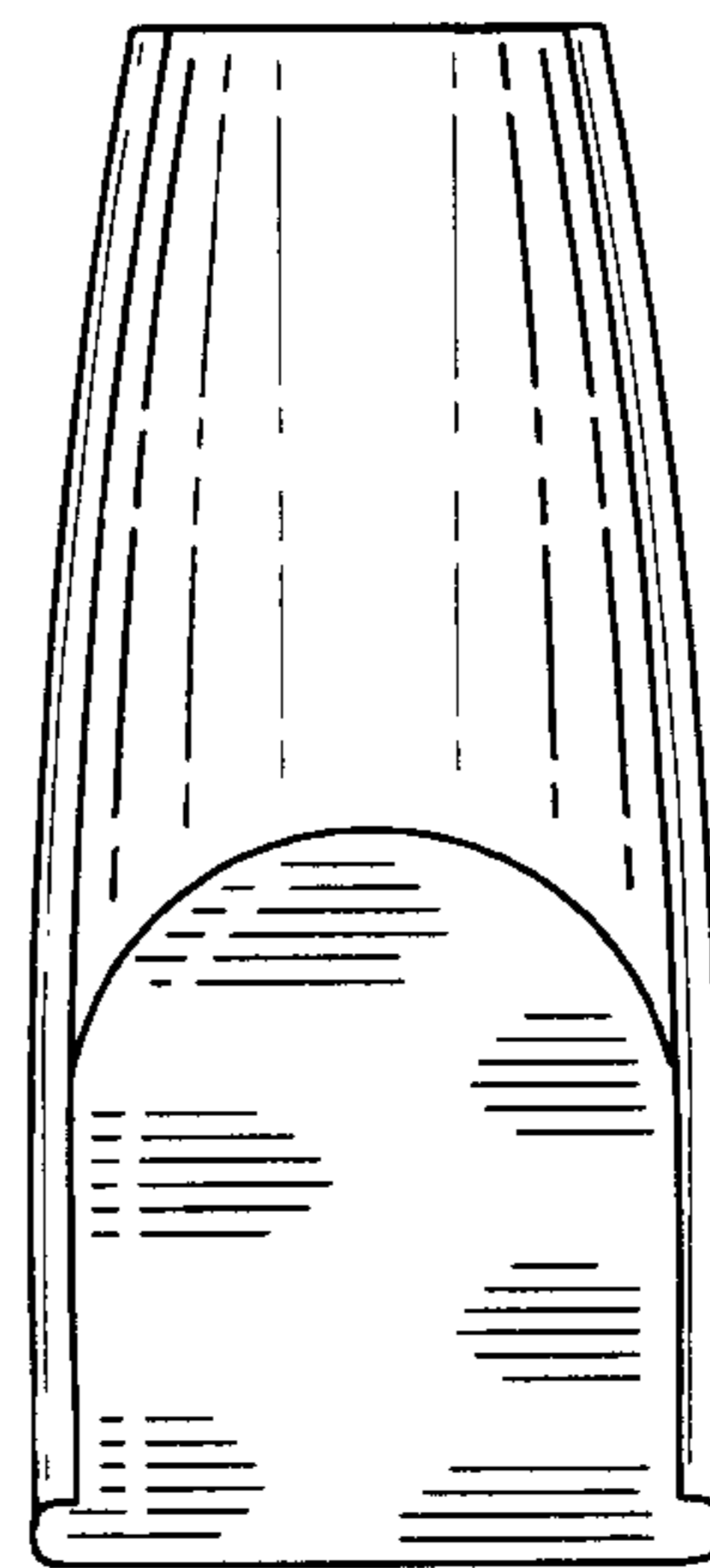

FIG. 4

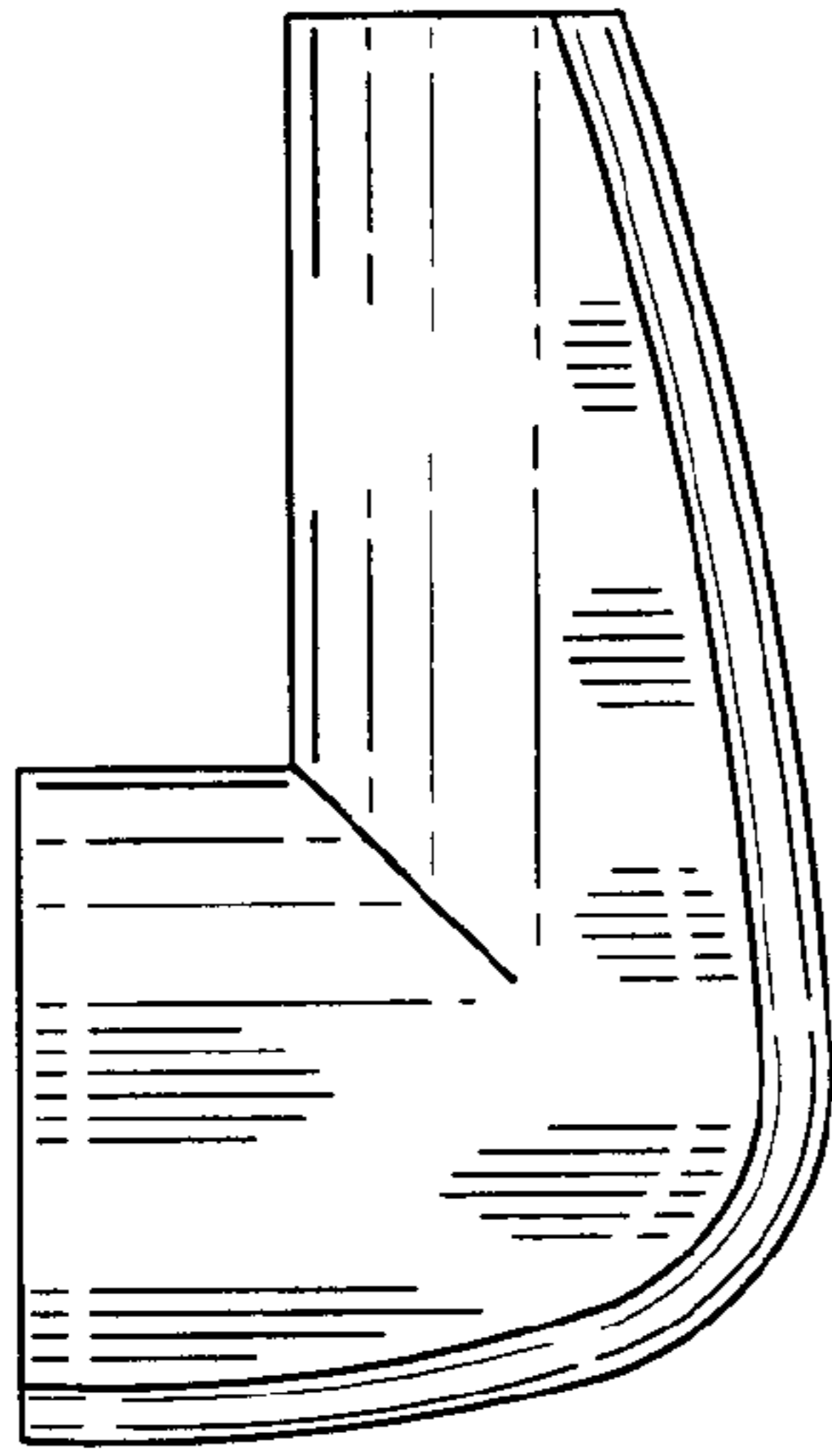

FIG. 5

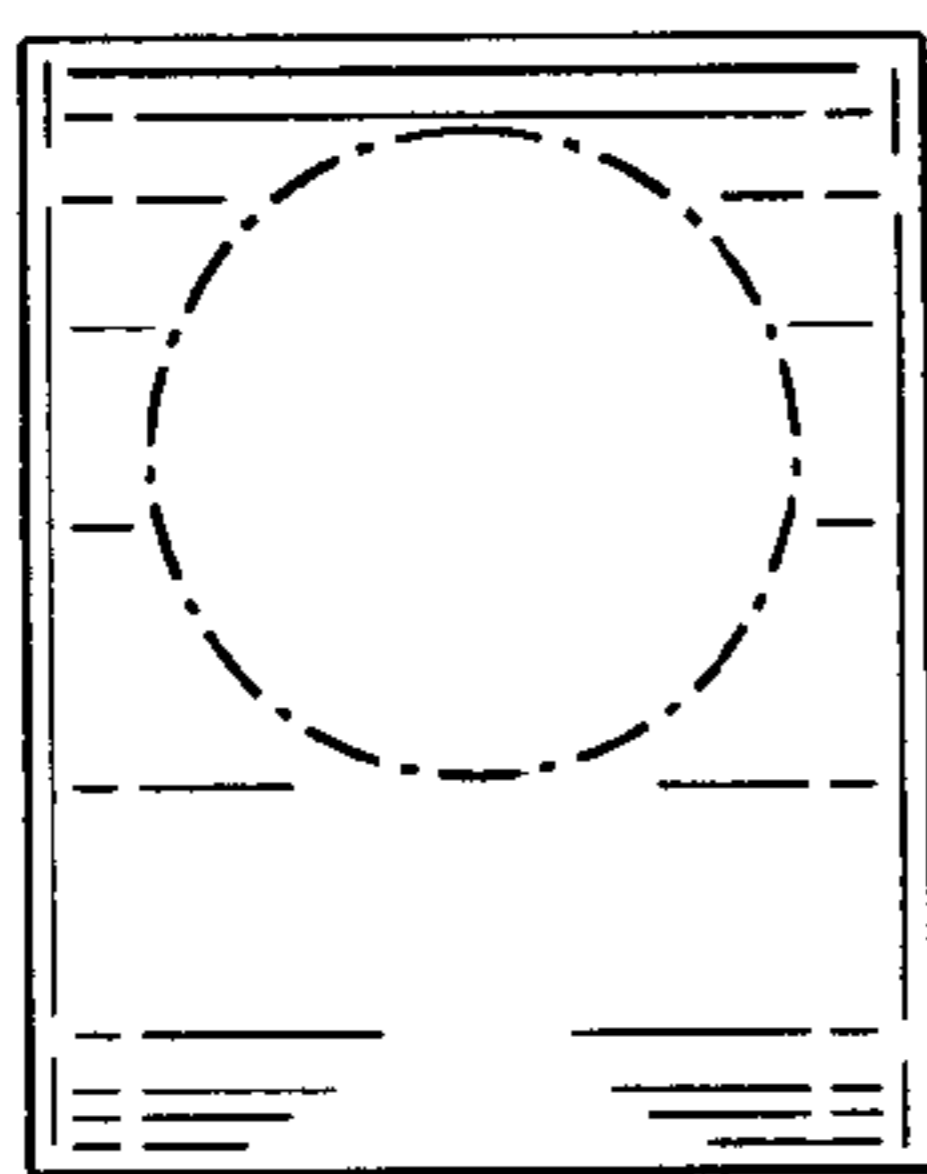

FIG. 6

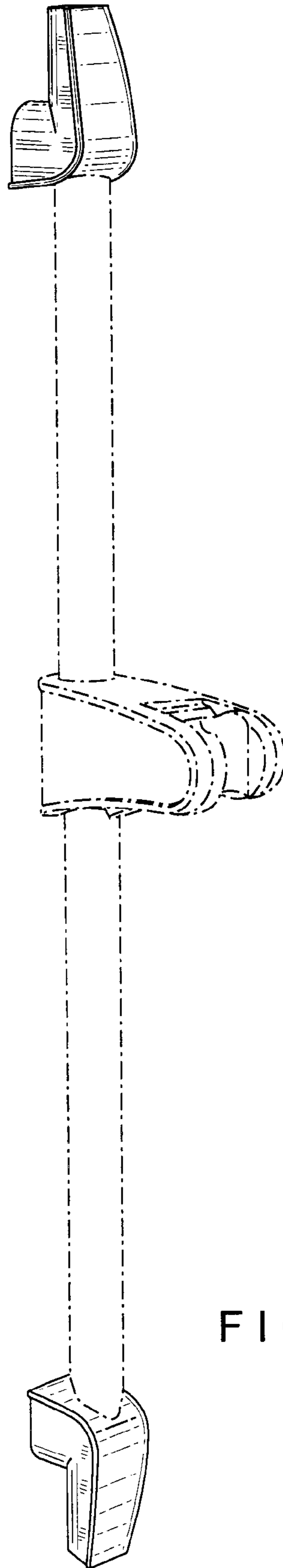

FIG. 7