



US00D534238S

(12) **United States Design Patent**
Sadler

(10) **Patent No.:** **US D534,238 S**

(45) **Date of Patent:** **** Dec. 26, 2006**

(54) **SINGLE HEAD ADJUSTABLE SHOWER FITTING**

5,230,472 A * 7/1993 McCabe 239/443
D450,804 S * 11/2001 Srinath et al. D23/213
D503,211 S * 3/2005 Lin D23/213
D506,242 S * 6/2005 Spangler D23/213

(75) Inventor: **Marc Sadler**, Milan (IT)

* cited by examiner

(73) Assignee: **American Standard Europe B.V.B.A.**,
Brussels (BE)

Primary Examiner—Robin Webster

(**) Term: **14 Years**

(57) **CLAIM**

(21) Appl. No.: **29/230,686**

The ornamental design for a single head adjustable shower fitting, as shown and described.

(22) Filed: **May 25, 2005**

DESCRIPTION

(30) **Foreign Application Priority Data**

Nov. 29, 2004 (EM) 000259155

(51) **LOC (8) Cl.** **23-01**

(52) **U.S. Cl.** **D23/213**

(58) **Field of Classification Search** D23/213,
D23/229–230; D24/201; 4/541.6; 239/282–3,
239/587.1, 587.5, 587.6

See application file for complete search history.

FIG. 1 is a bottom perspective view of a single head adjustable shower fitting showing my new design;
FIG. 2 is a top perspective view thereof;
FIG. 3 is a front view thereof;
FIG. 4 is a bottom view thereof;
FIG. 5 is a left side view thereof;
FIG. 6 is a right side view thereof;
FIG. 7 is a rear view thereof; and,
FIG. 8 is a top view thereof.

The broken line showing in FIGS. 2 and 8 is for illustrative purposes only and forms no part of the claimed design.

(56) **References Cited**

U.S. PATENT DOCUMENTS

D297,160 S * 8/1988 Robbins D23/213

1 Claim, 3 Drawing Sheets

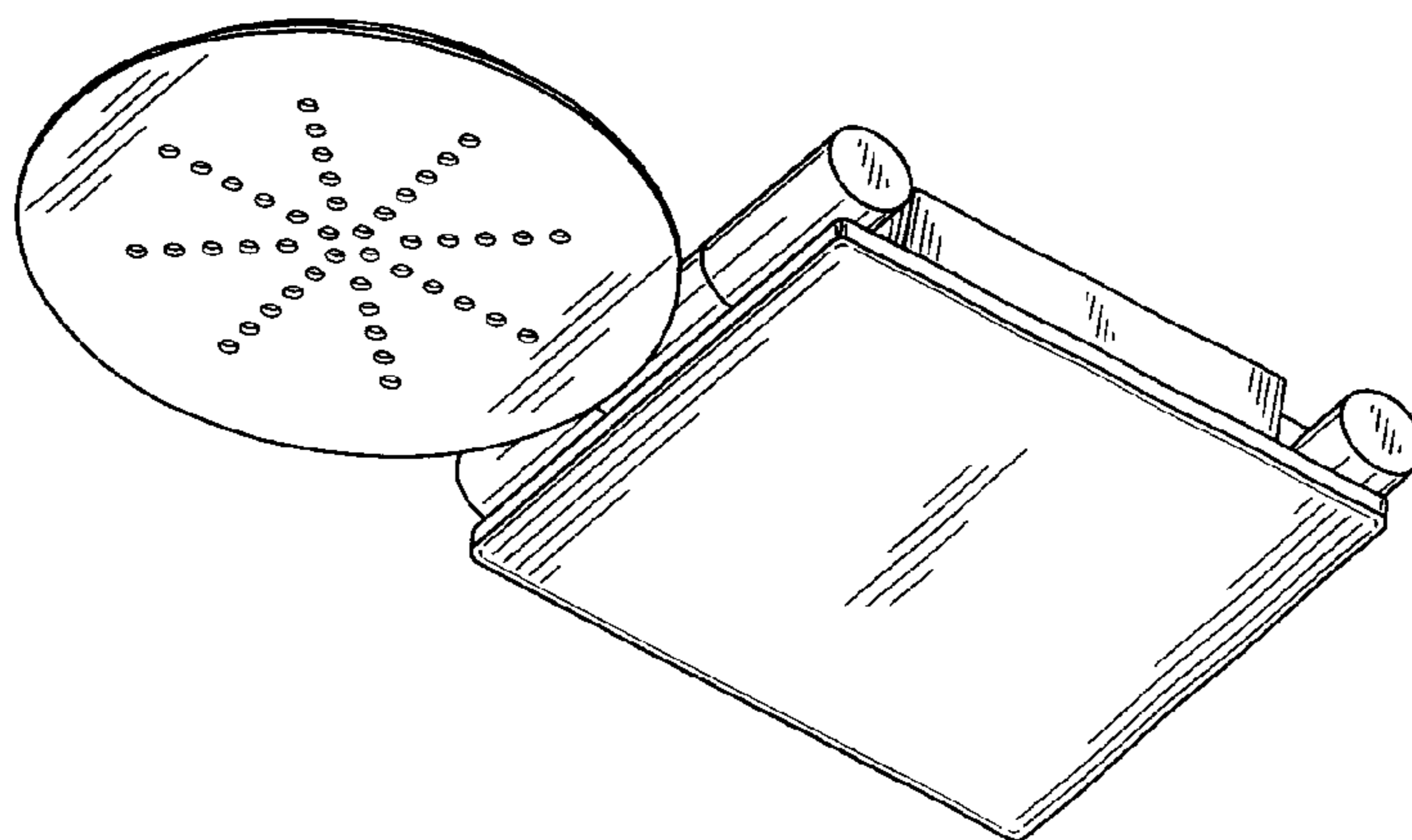

FIG. 2

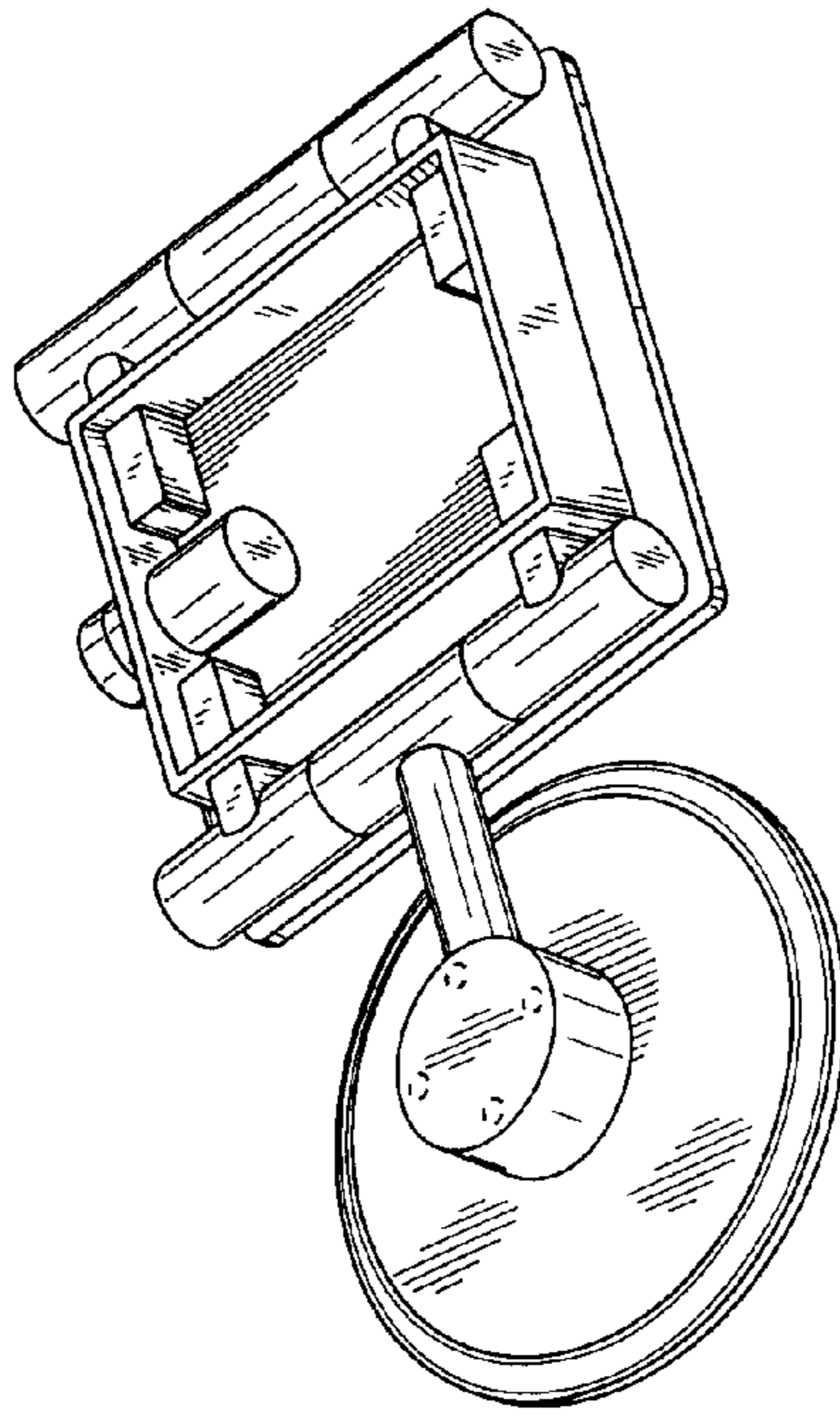
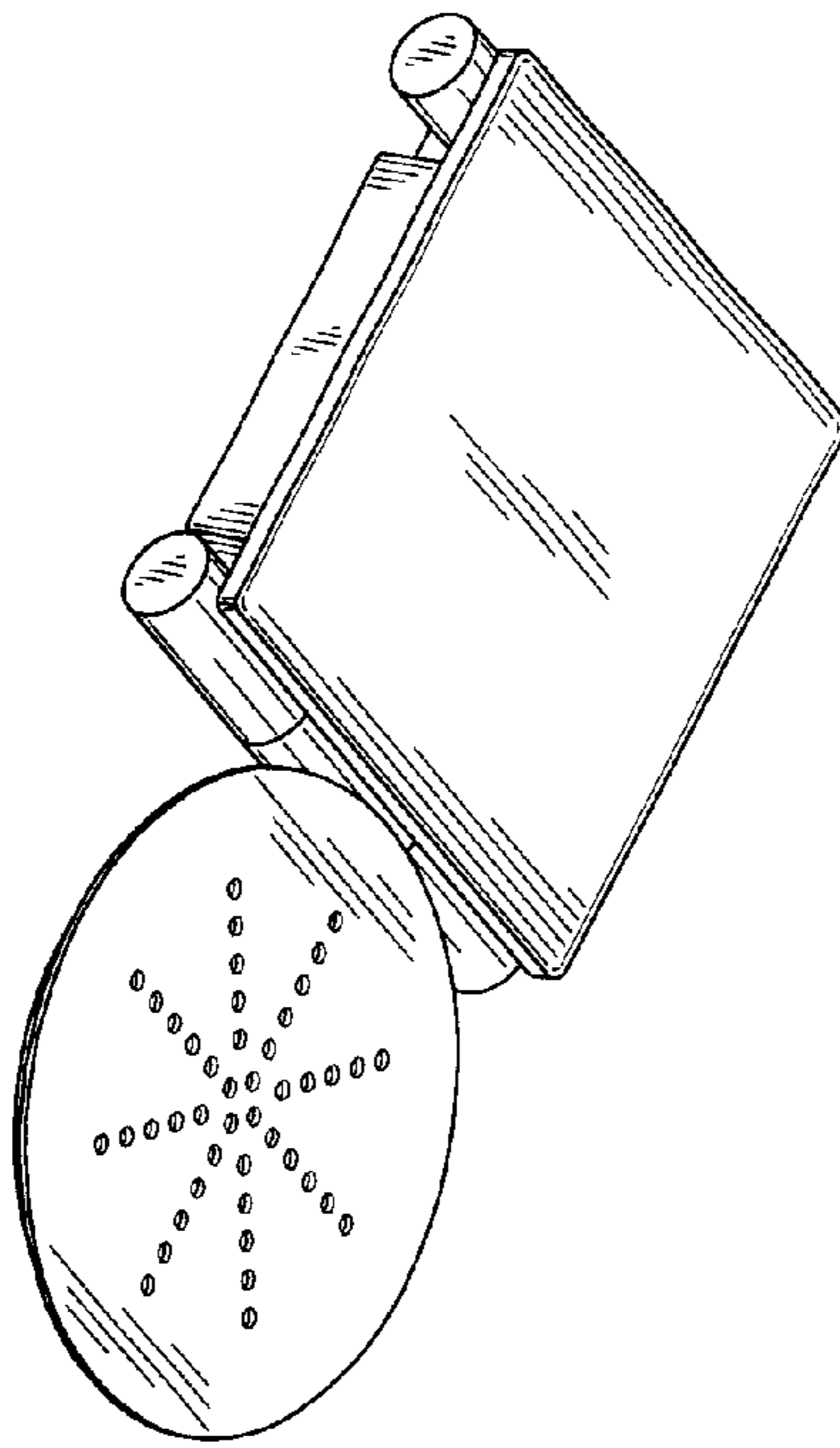

FIG. 1



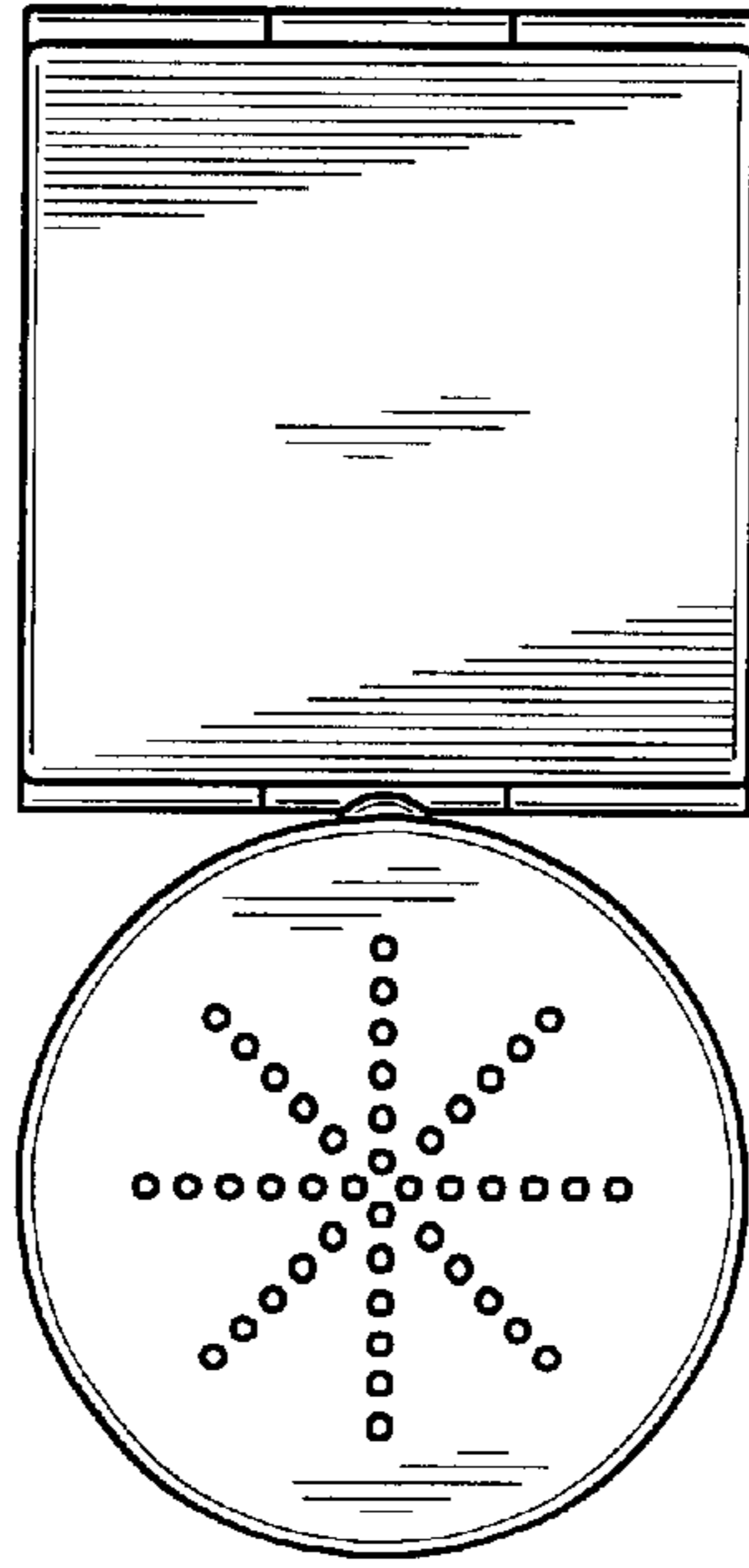

FIG. 4

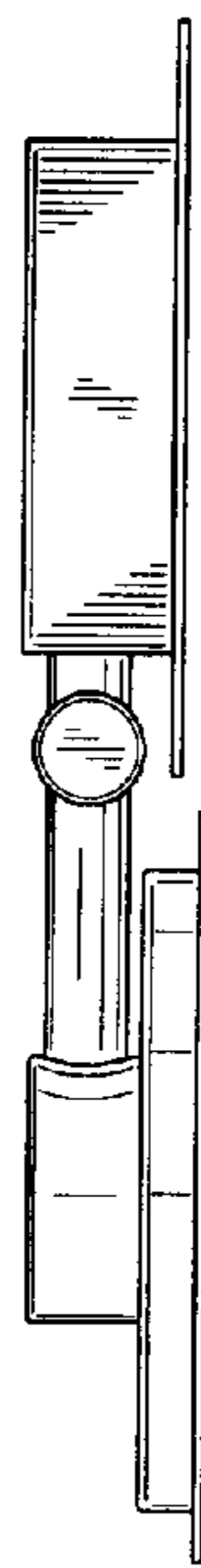

FIG. 3

FIG. 5



FIG. 6

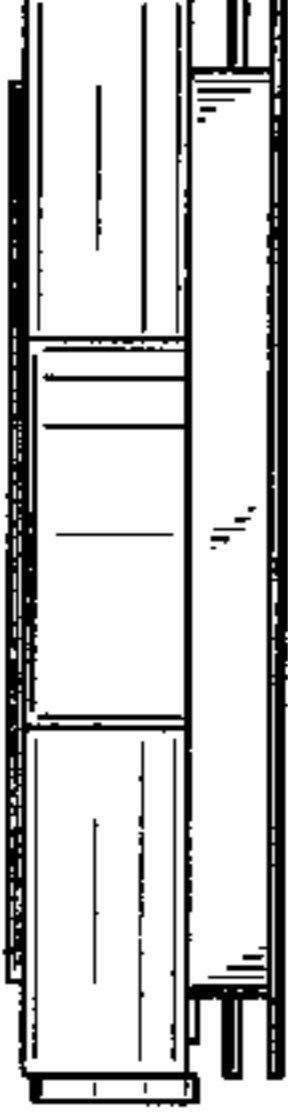

FIG. 7

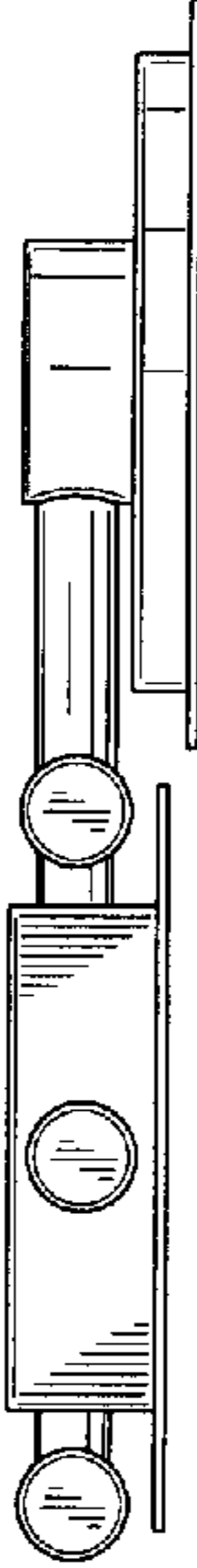

FIG. 8

