



US00D534228S

(12) **United States Design Patent** (10) **Patent No.:** **US D534,228 S**
Nicolette et al. (45) **Date of Patent:** **** Dec. 26, 2006**

(54) **GOLF IRON HEAD**

(75) Inventors: **Michael R. Nicolette**, Scottsdale, AZ (US); **Bradley D. Schweigert**, Anthem, AZ (US); **Marty R. Jertson**, Phoenix, AZ (US); **John A. Solheim**, Phoenix, AZ (US); **Eric V. Cole**, Phoenix, AZ (US)

(73) Assignee: **Karsten Manufacturing Corporation**, Phoenix, AZ (US)

(**) Term: **14 Years**

(21) Appl. No.: **29/242,025**

(22) Filed: **Nov. 2, 2005**

(51) **LOC (8) Cl.** **21-02**

(52) **U.S. Cl.** **D21/749**

(58) **Field of Classification Search** D21/747-751;
473/324-331, 350

See application file for complete search history.

(56) **References Cited**

U.S. PATENT DOCUMENTS

D228,355 S	*	9/1973	Penna	D21/749
D256,264 S		8/1980	Solheim		
D379,393 S		5/1997	Kubica		
D422,043 S		3/2000	Kubica		
D429,299 S		8/2000	Kubica		
D442,659 S	*	5/2001	Kubica et al.	D21/747
D443,008 S		5/2001	Kubica		
D468,787 S	*	1/2003	Oosthuizen	D21/747
D469,136 S	*	1/2003	Roberts	D21/747
D470,554 S	*	2/2003	Truesdale	D21/747
D494,648 S		8/2004	Schweigert		
D500,350 S		12/2004	Schweigert		
D500,351 S	*	12/2004	Schweigert et al.	D21/747
D502,237 S		2/2005	Schweigert		

D502,975 S		3/2005	Schweigert		
D504,925 S	*	5/2005	Schweigert et al.	D21/748
D505,171 S	*	5/2005	Schweigert et al.	D21/749
D507,029 S	*	7/2005	Burrows	D21/747
D507,614 S	*	7/2005	Schweigert et al.	D21/747
D508,099 S	*	8/2005	Schweigert et al.	D21/749
D514,183 S	*	1/2006	Schweigert et al.	D21/748

* cited by examiner

Primary Examiner—Mitchell Siegel

(74) *Attorney, Agent, or Firm*—Darrell F. Marquette

(57) **CLAIM**

The ornamental design for a golf iron head, as shown and described.

DESCRIPTION

FIG. 1 is a perspective view of a golf iron head with a low loft angle such as a 2-iron showing our new design; FIG. 2 is a toe end view of the golf iron head of FIG. 1; FIG. 3 is a heel end view of the golf iron head of FIG. 1; FIG. 4 is a top view of the golf iron head of FIG. 1; FIG. 5 is a bottom view of the golf iron head of FIG. 1; FIG. 6 is a front elevational view of the golf iron head of FIG. 1; FIG. 7 is a rear elevational view of the golf iron head of FIG. 1; FIG. 8 is a perspective view of a golf iron head with a medium loft angle such as a 5-iron showing our new design; FIG. 9 is a toe end view of the golf iron head of FIG. 8; FIG. 10 is a heel end view of the golf iron head of FIG. 8; FIG. 11 is a top view of the golf iron head of FIG. 8; FIG. 12 is a bottom view of the golf iron head of FIG. 8; FIG. 13 is a front elevational view of the golf iron head of FIG. 8; and, FIG. 14 is a rear elevational view of the golf iron head of FIG. 8.

1 Claim, 4 Drawing Sheets

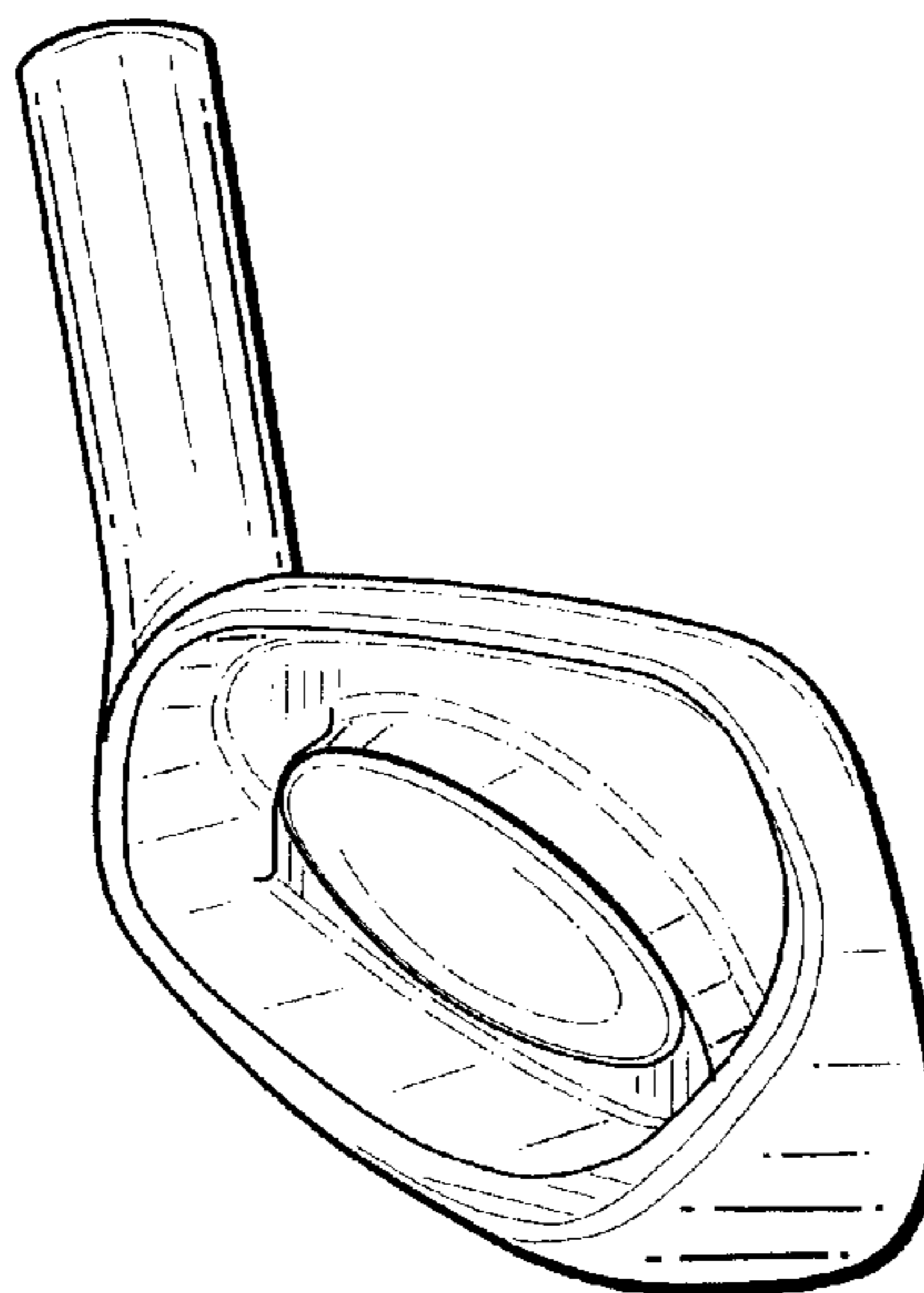

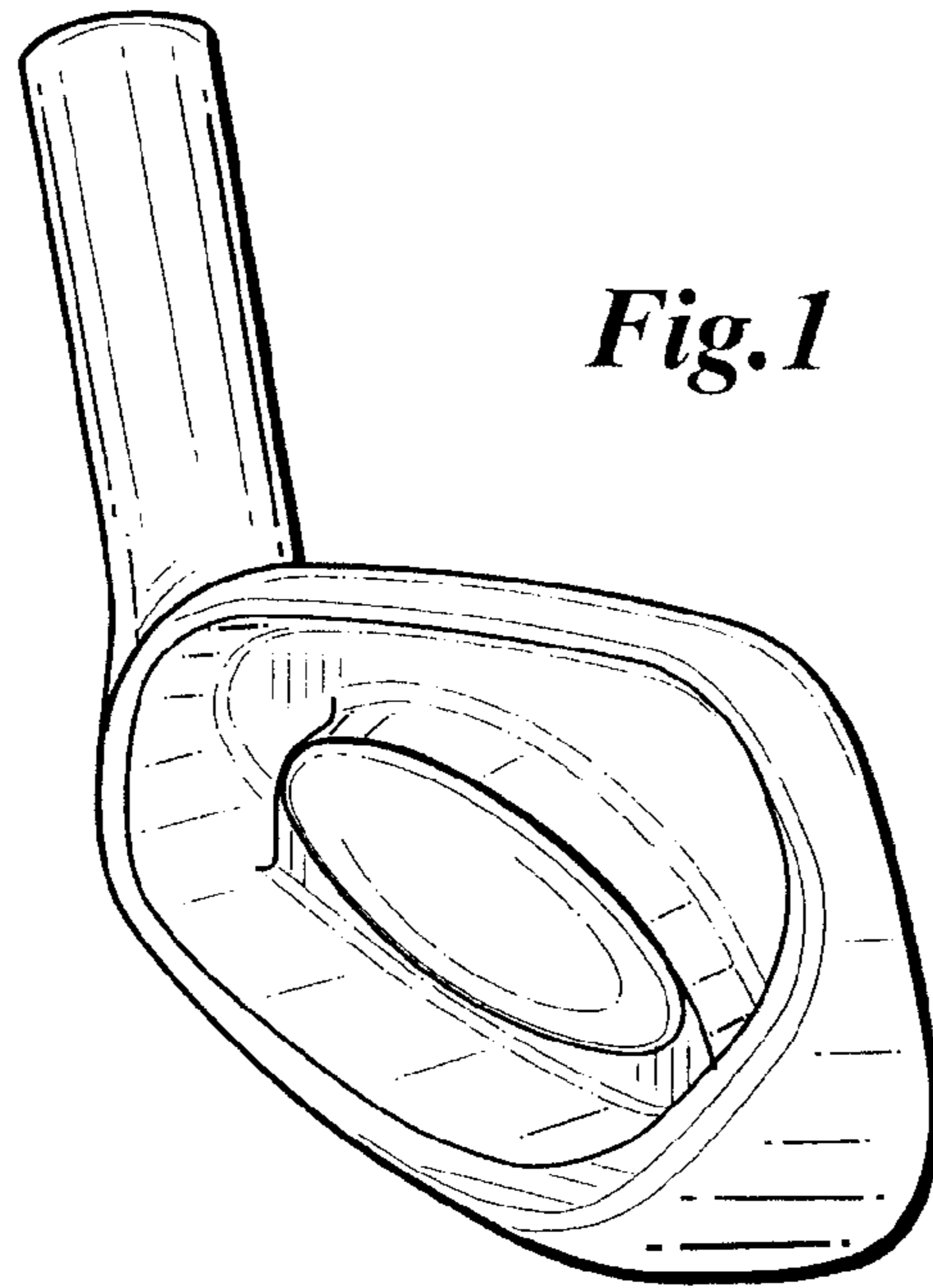

Fig. 2

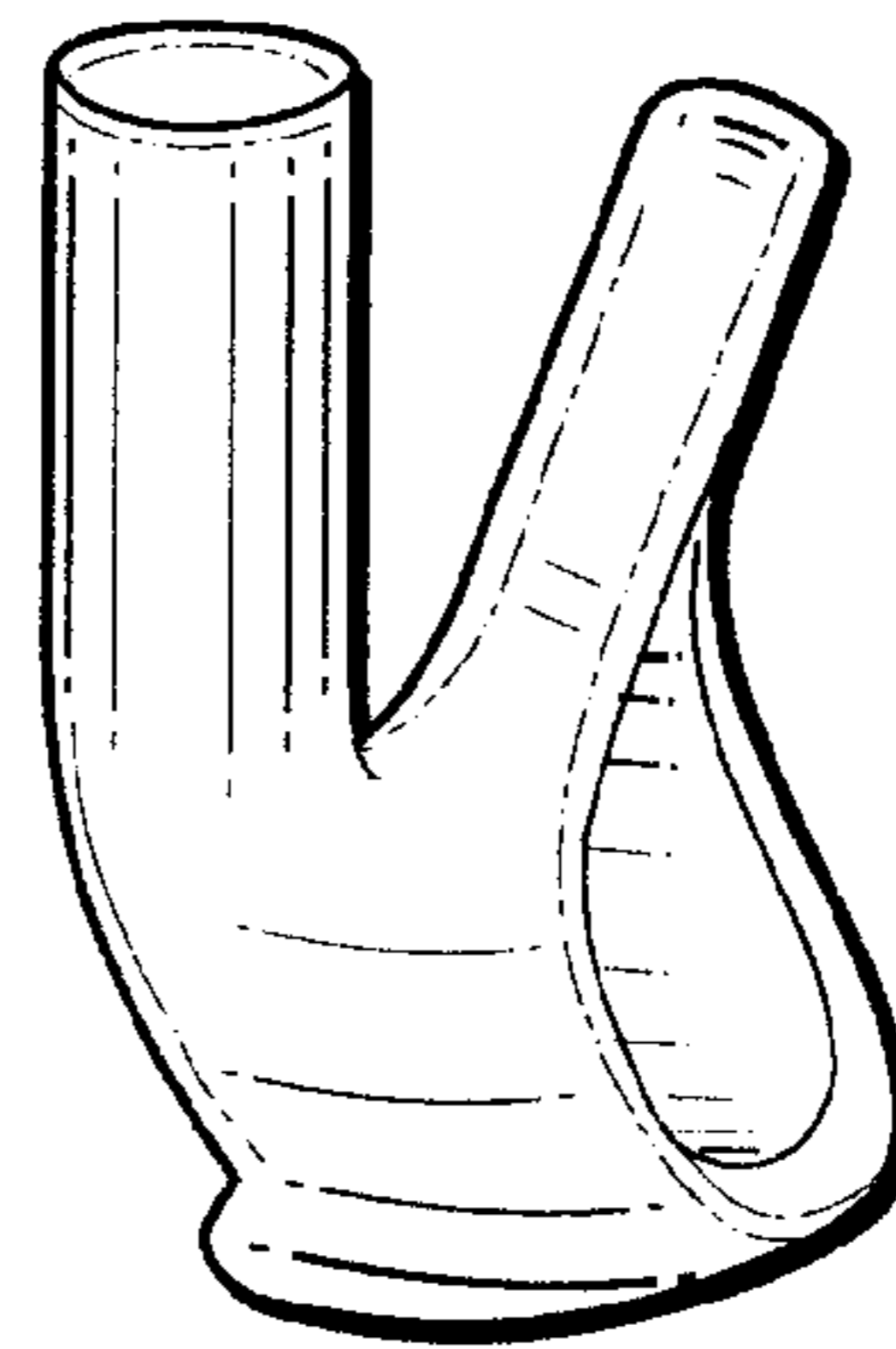
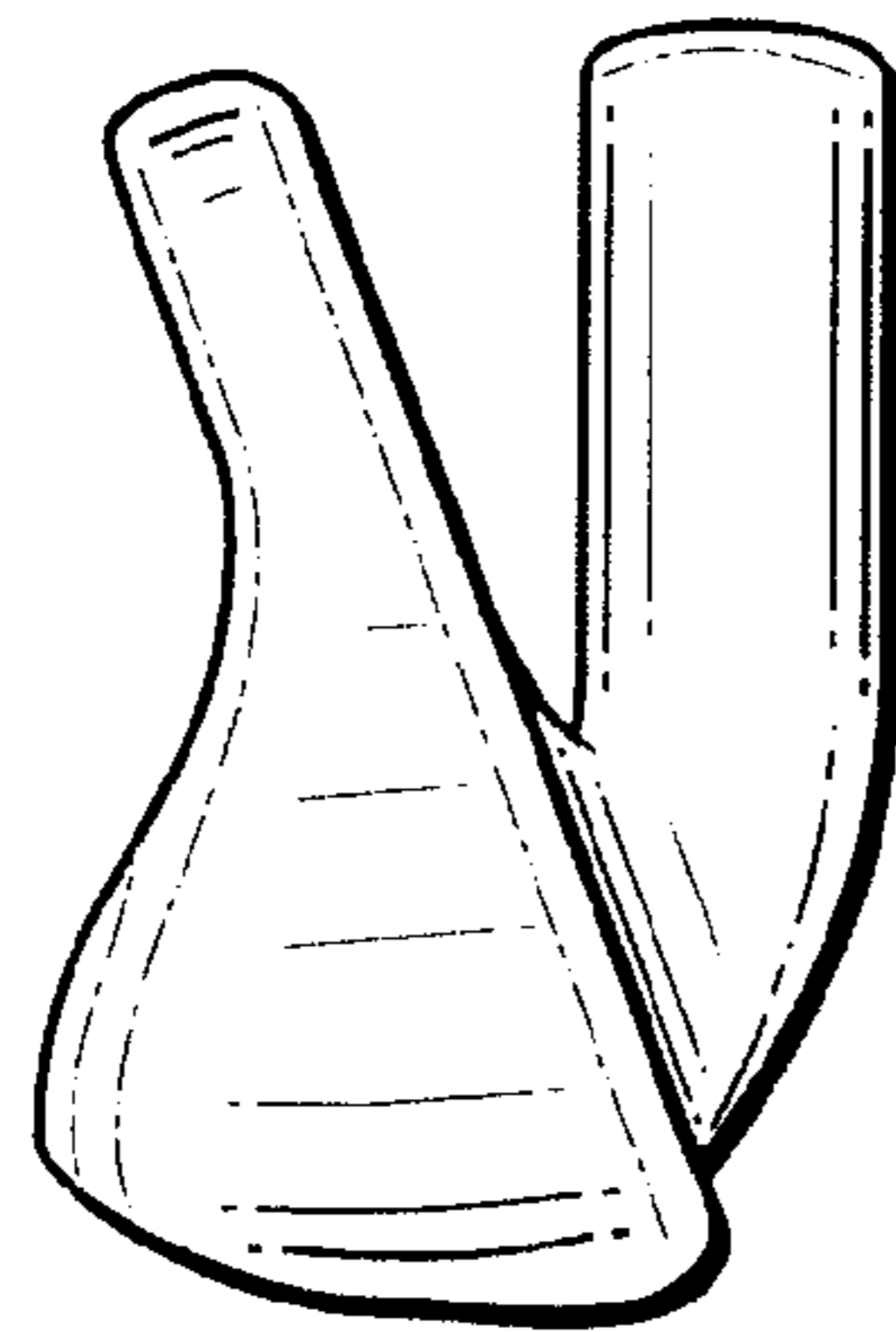

Fig. 3

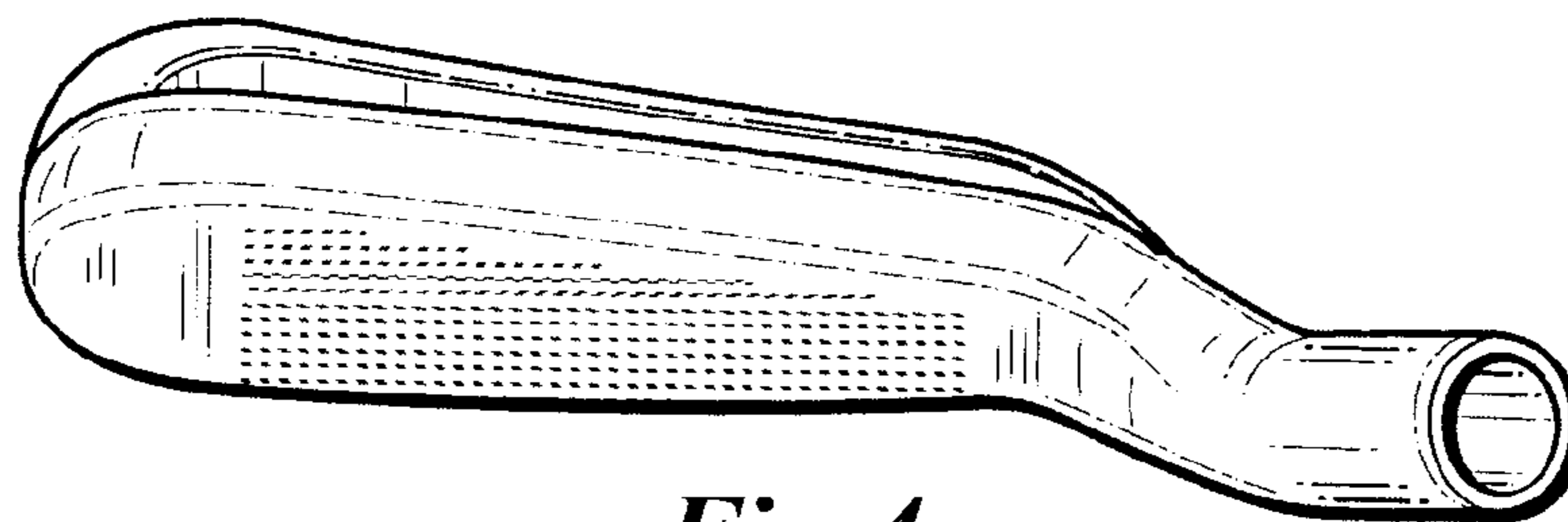

Fig. 4

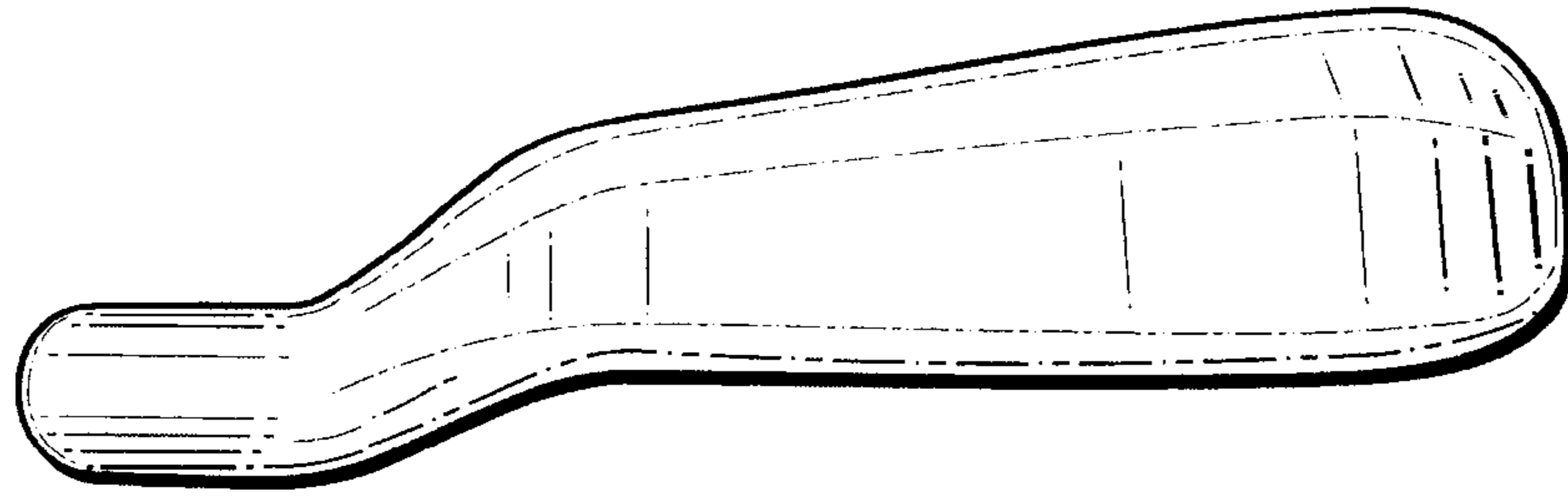

Fig. 5

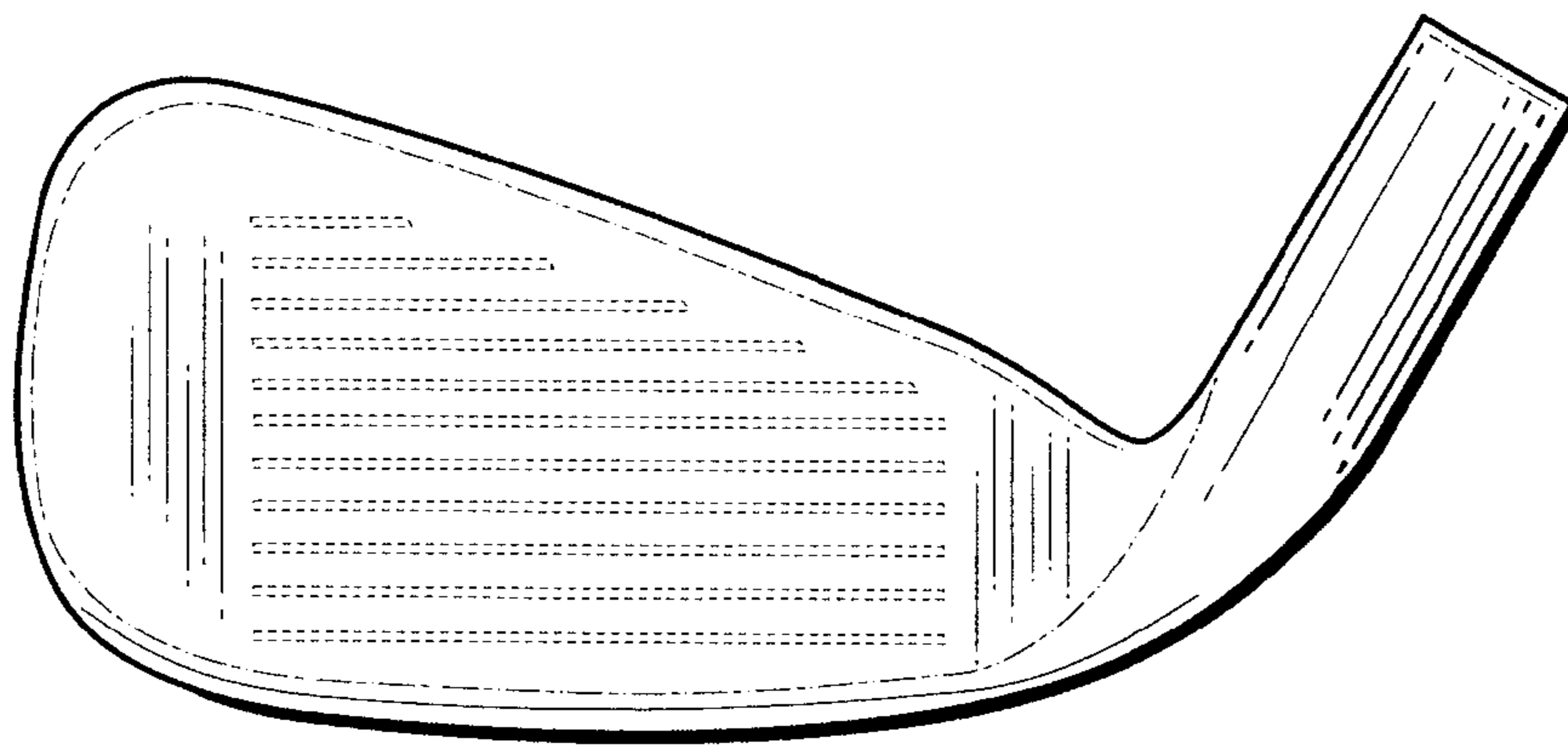

Fig. 6

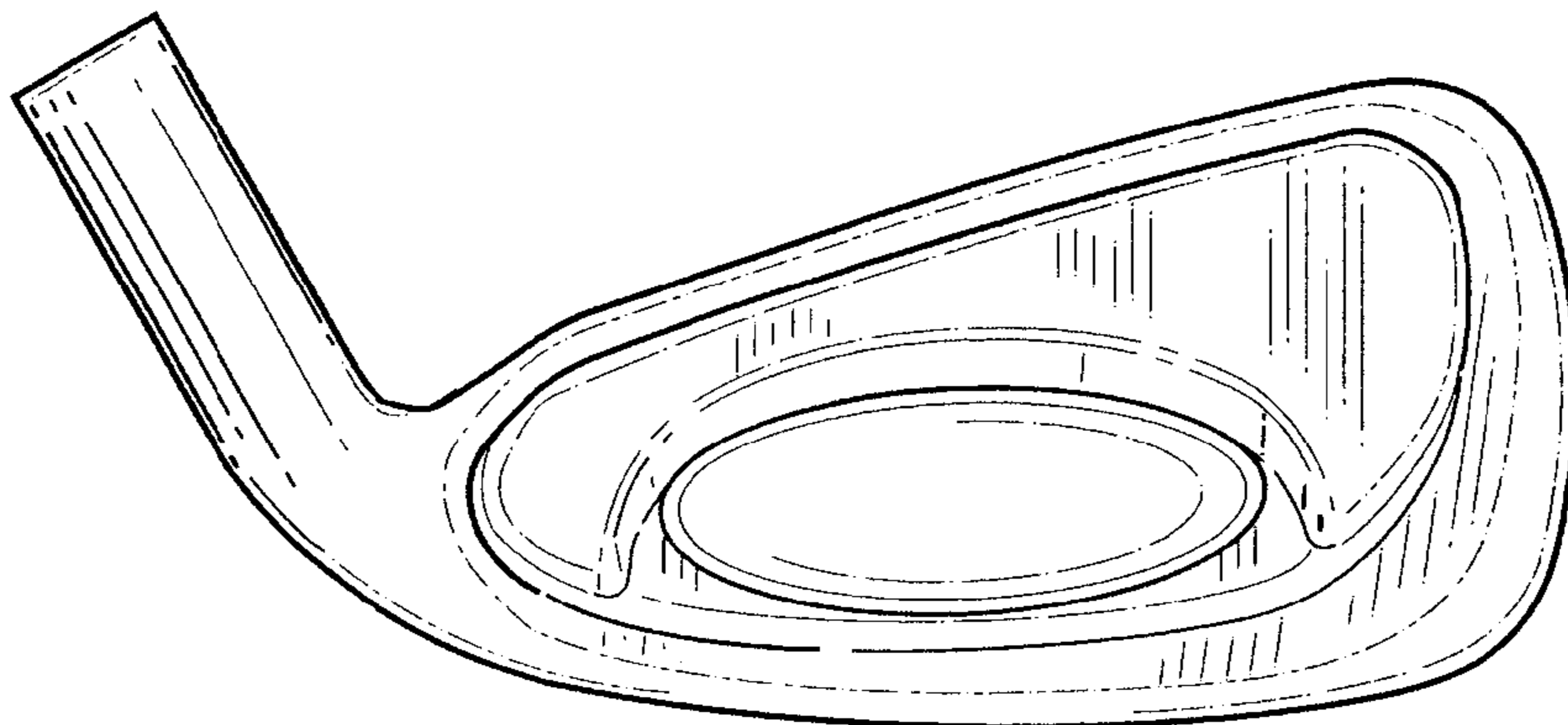

Fig. 7

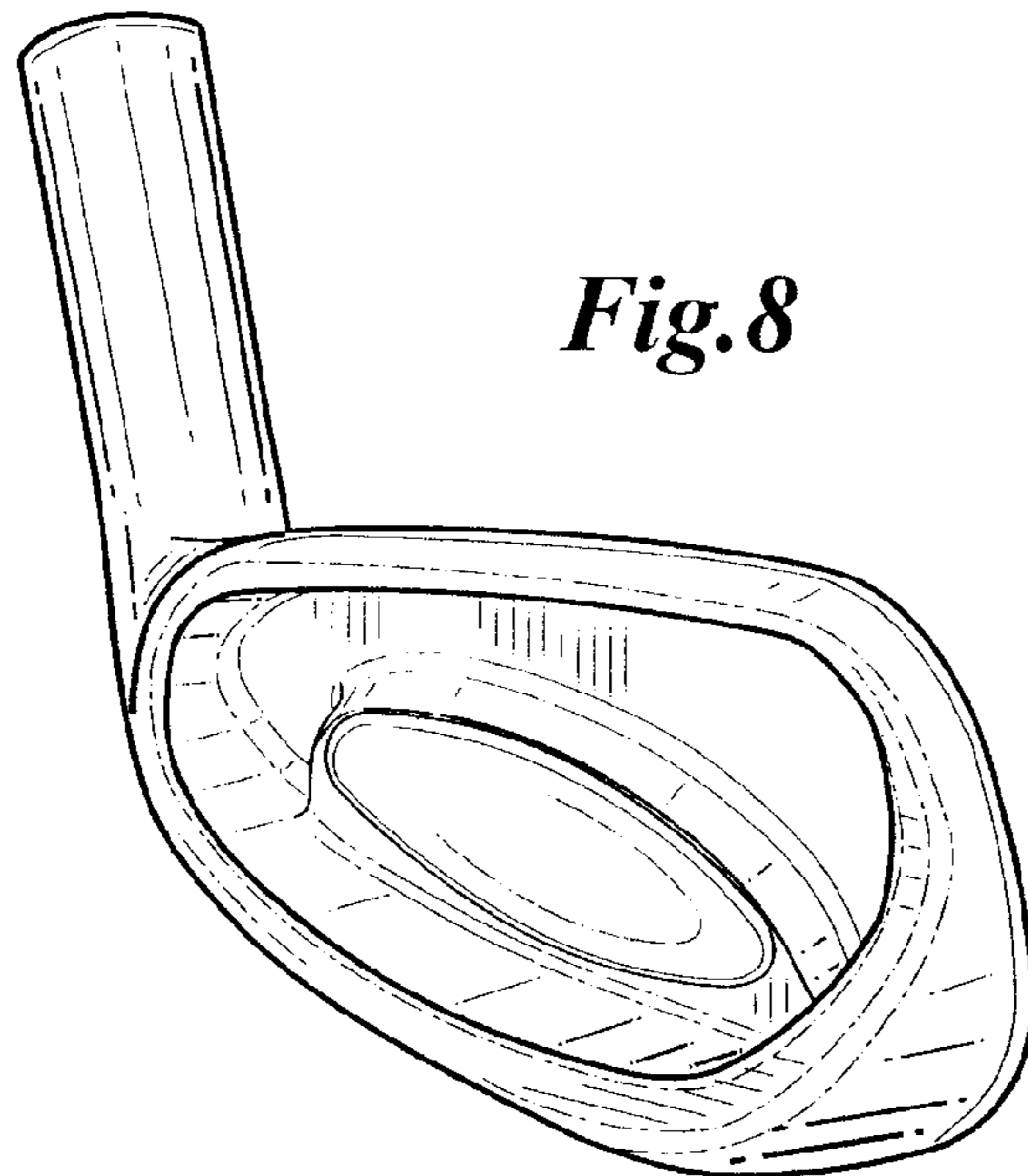

Fig. 9

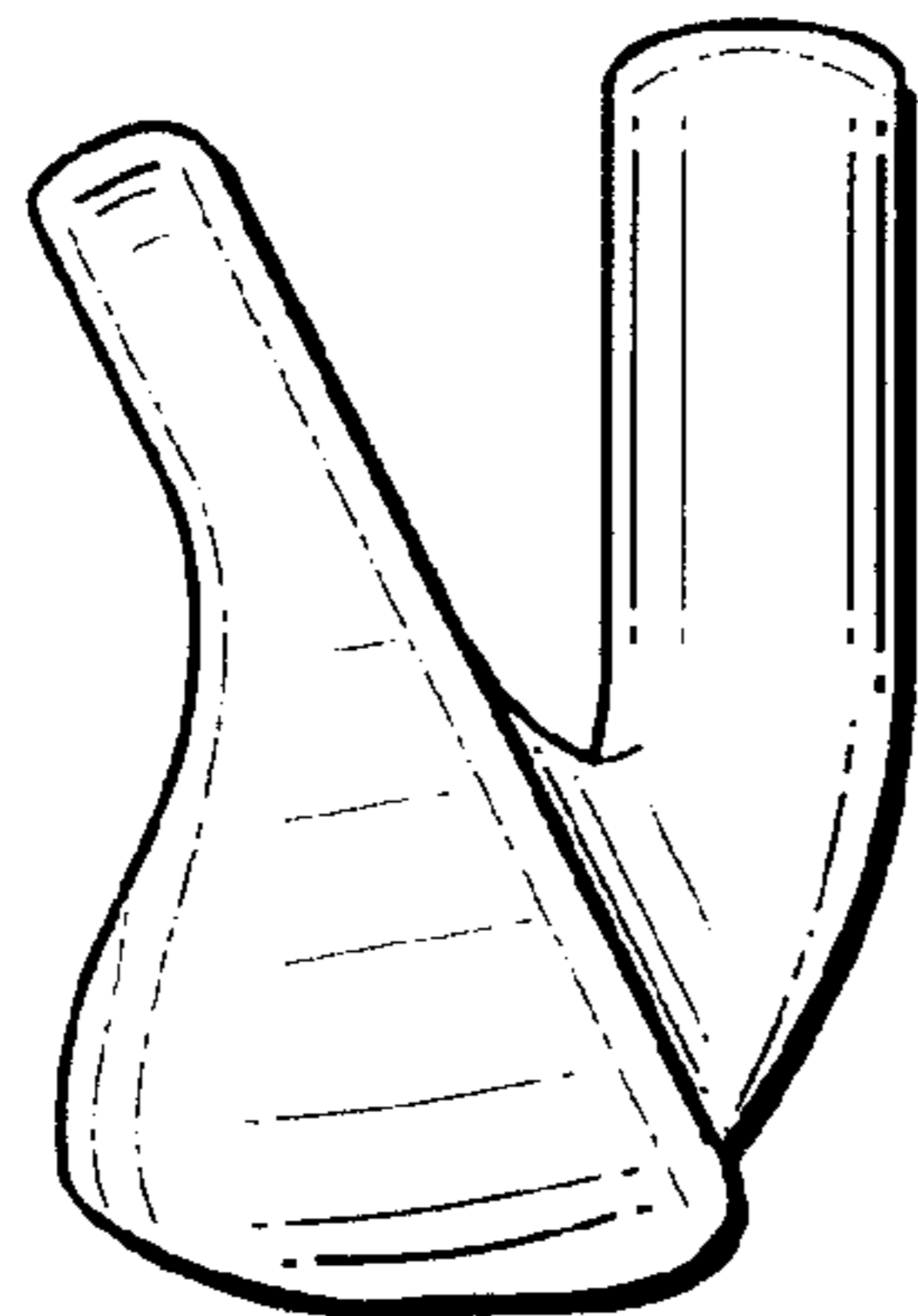

Fig. 10

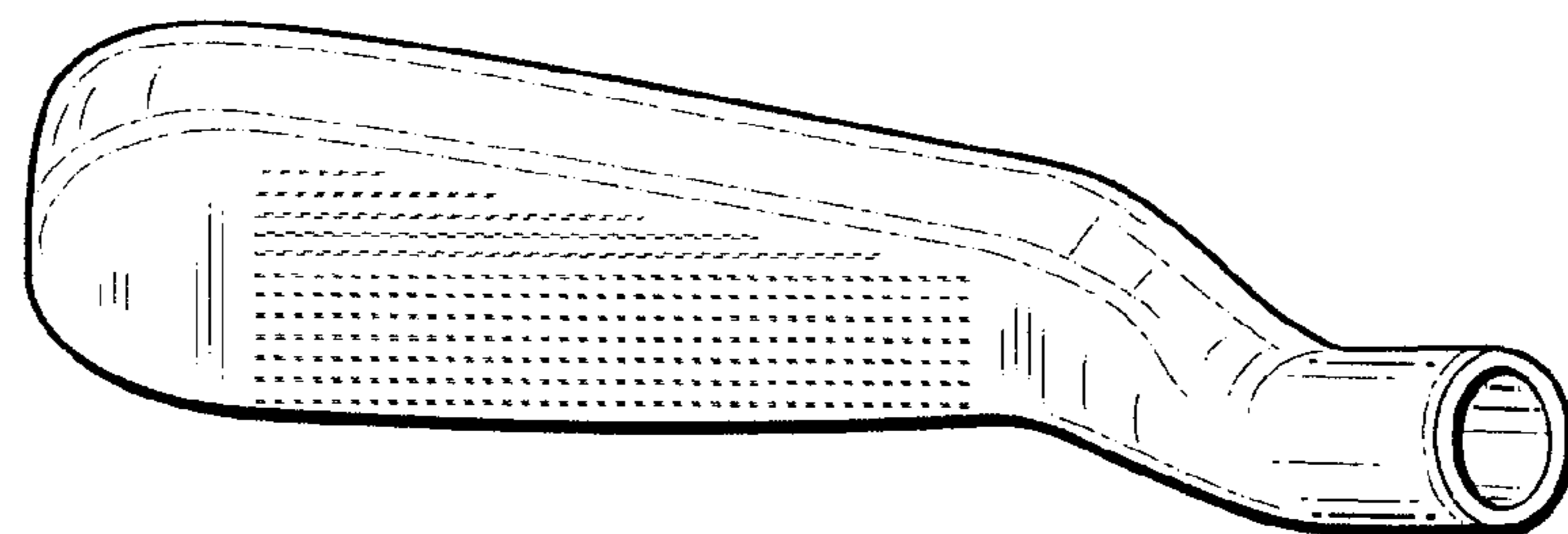
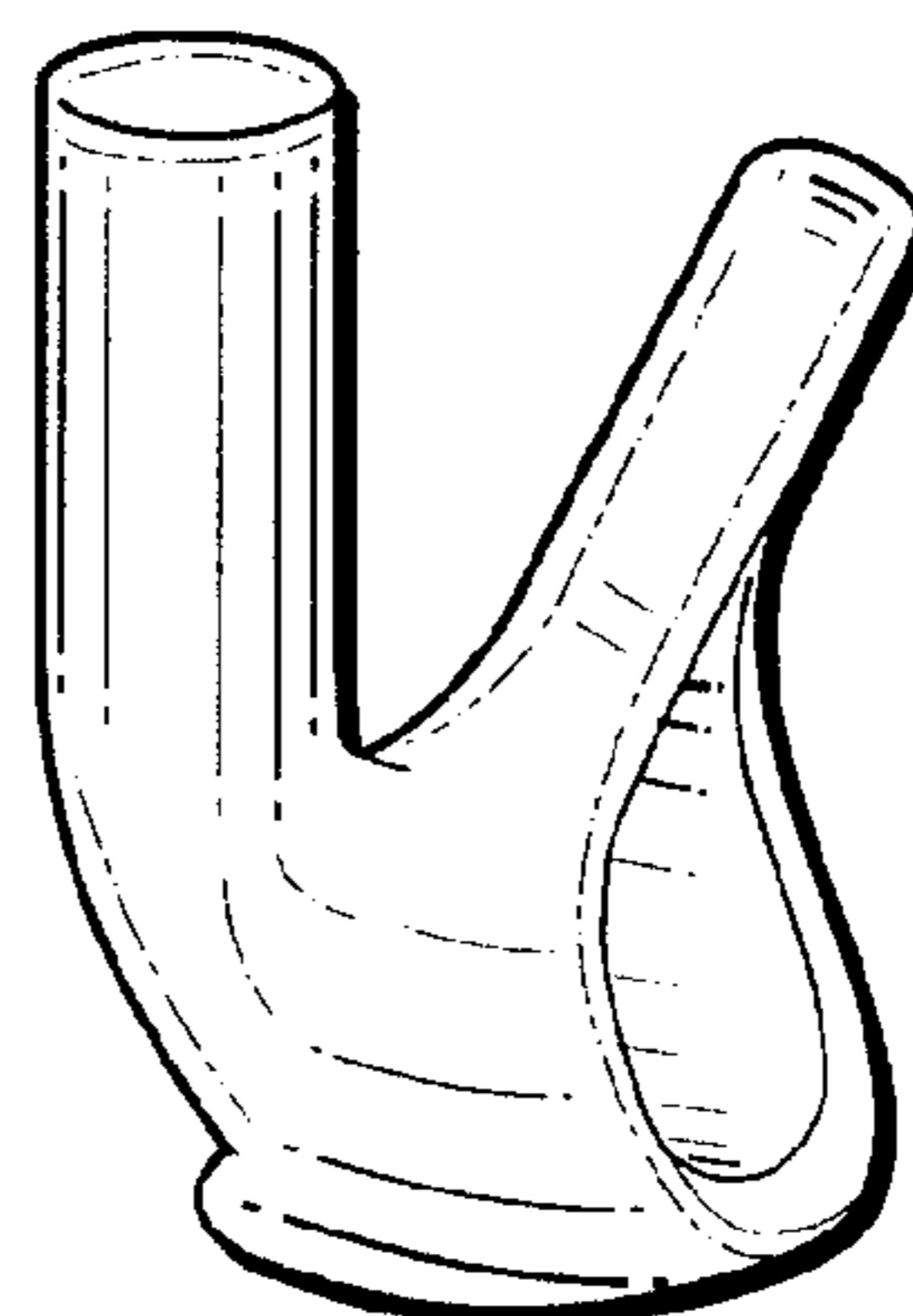

Fig. 11

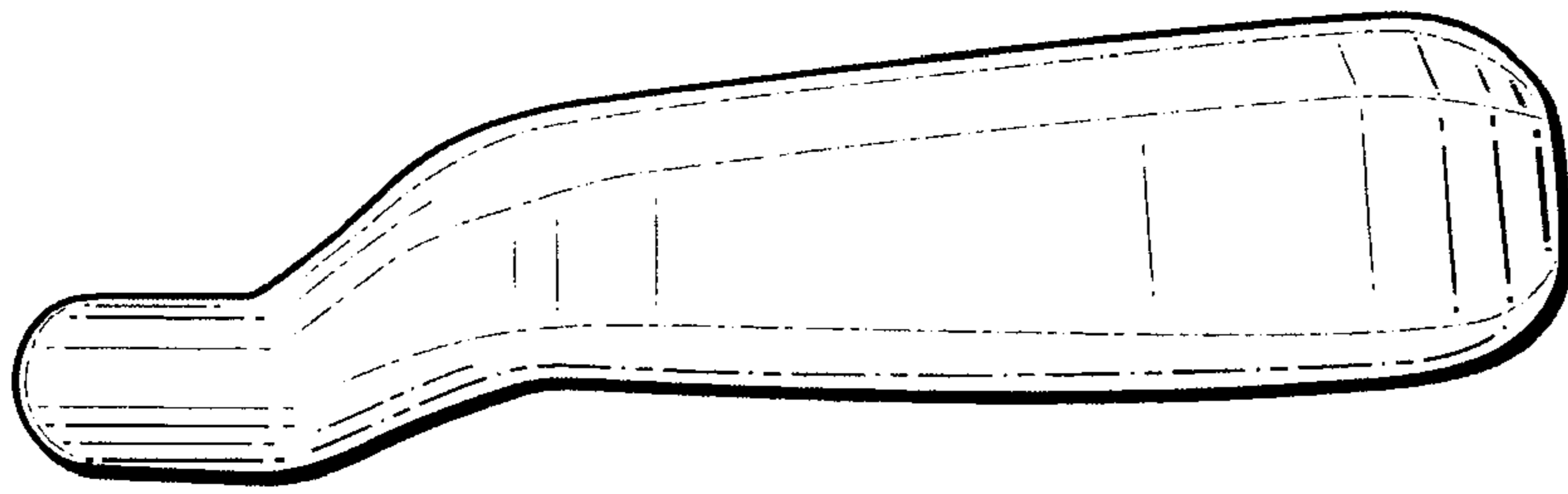

Fig. 12

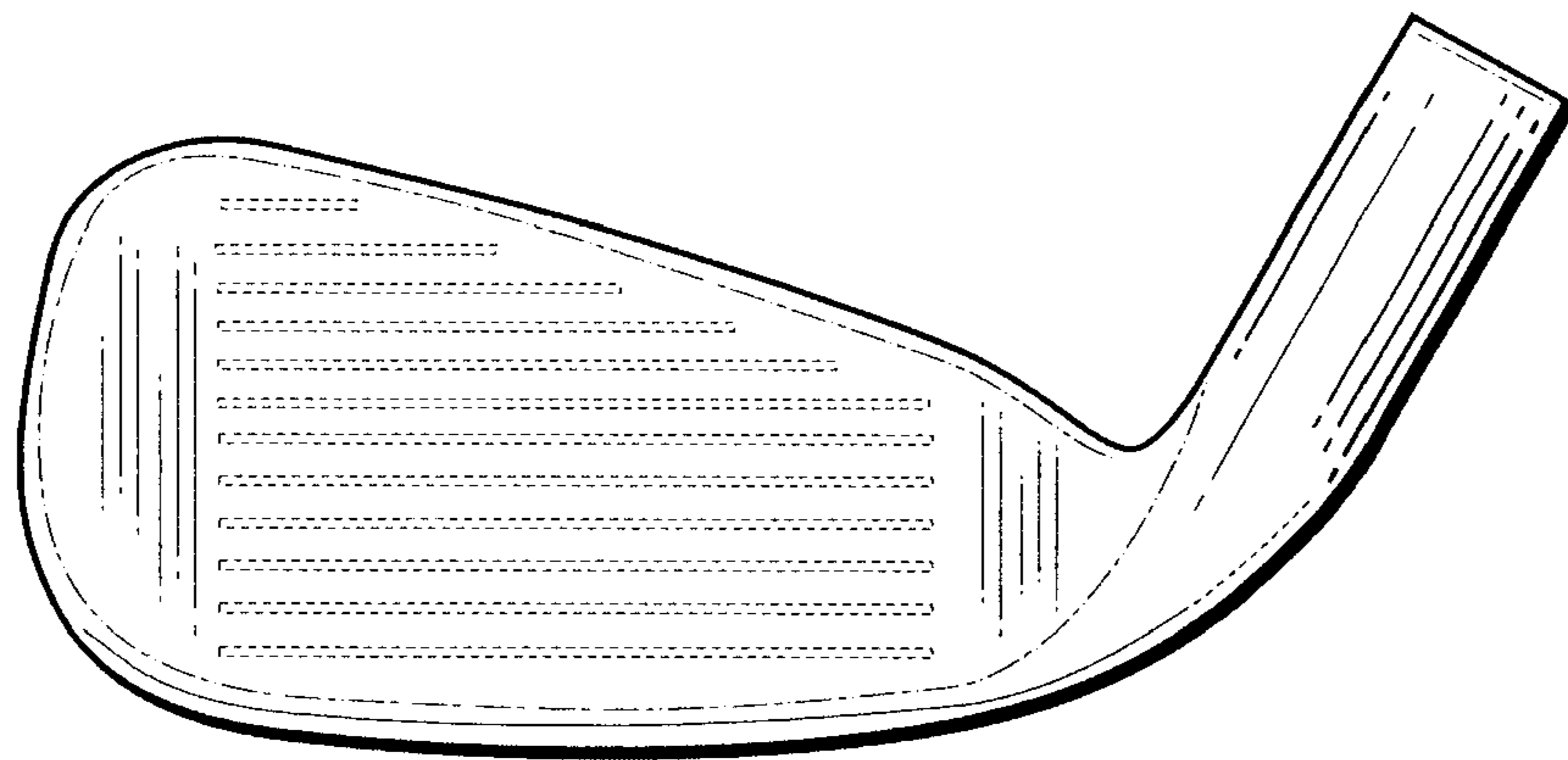

Fig. 13

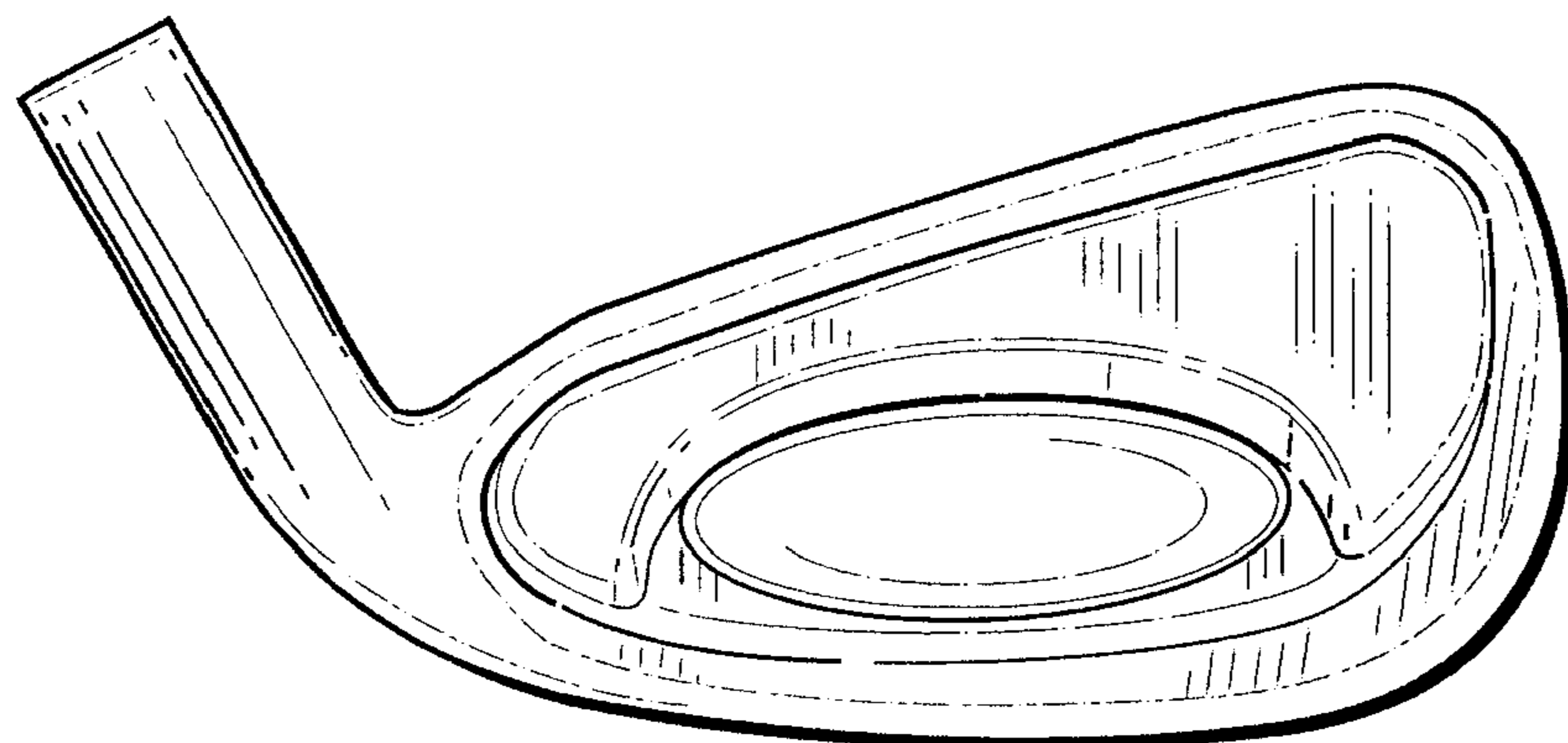

Fig. 14