



US00D534193S

(12) **United States Design Patent**
Ono

(10) **Patent No.:** **US D534,193 S**

(45) **Date of Patent:** **** Dec. 26, 2006**

(54) **SPOTTING SCOPE**

D439,259 S * 3/2001 Yamaguchi D16/132
D454,144 S * 3/2002 Ogasawara et al. D16/132

(75) Inventor: **Arata Ono**, Odawara (JP)

FOREIGN PATENT DOCUMENTS

(73) Assignee: **Nikon Corporation**, Tokyo (JP)

JP 1022357 10/1997
JP 1020835 9/1998

(**) Term: **14 Years**

OTHER PUBLICATIONS

(21) Appl. No.: **29/243,823**

Pentax; Binoculars & Spotting Scopes; Select Guide; 4 pages.

(22) Filed: **Dec. 1, 2005**

VIXEN; Binoculars, Fieldscopes & Compasses; Collection 2005; pp. 7 pages.

(30) **Foreign Application Priority Data**

Aug. 17, 2005 (JP) 2005-023785

* cited by examiner

(51) **LOC (8) Cl.** **16-06**

Primary Examiner—Paula A. Greene

(52) **U.S. Cl.** **D16/132**

(74) *Attorney, Agent, or Firm*—Oliff & Berridge, PLC

(58) **Field of Classification Search** D16/130,
D16/131, 132, 133, 134; D22/108, 109, 110;
359/350, 351, 353, 399, 400, 404, 407, 419,
359/420, 422

(57) **CLAIM**

See application file for complete search history.

The ornamental design for a spotting scope, as shown.

DESCRIPTION

(56) **References Cited**

FIG. 1 is a front perspective view of a spotting scope showing my new design;

U.S. PATENT DOCUMENTS

FIG. 2 is a front elevational view thereof;

D190,886 S * 7/1961 Burlin D16/132
D215,355 S * 9/1969 Weatherby D16/132
D247,625 S * 3/1978 Huckenbeck D16/132
D285,698 S * 9/1986 Ogasawara D16/132
D300,039 S * 2/1989 Huckenbeck D16/132
D369,612 S * 5/1996 Yanagisawa D16/132
D374,022 S * 9/1996 Meinzer D16/132
5,946,132 A * 8/1999 Phillips 359/351

FIG. 3 is a rear elevational view thereof;

FIG. 4 is a left side view thereof;

FIG. 5 is a right side view thereof;

FIG. 6 is a top plan view thereof; and,

FIG. 7 is a bottom plan view position.

1 Claim, 3 Drawing Sheets

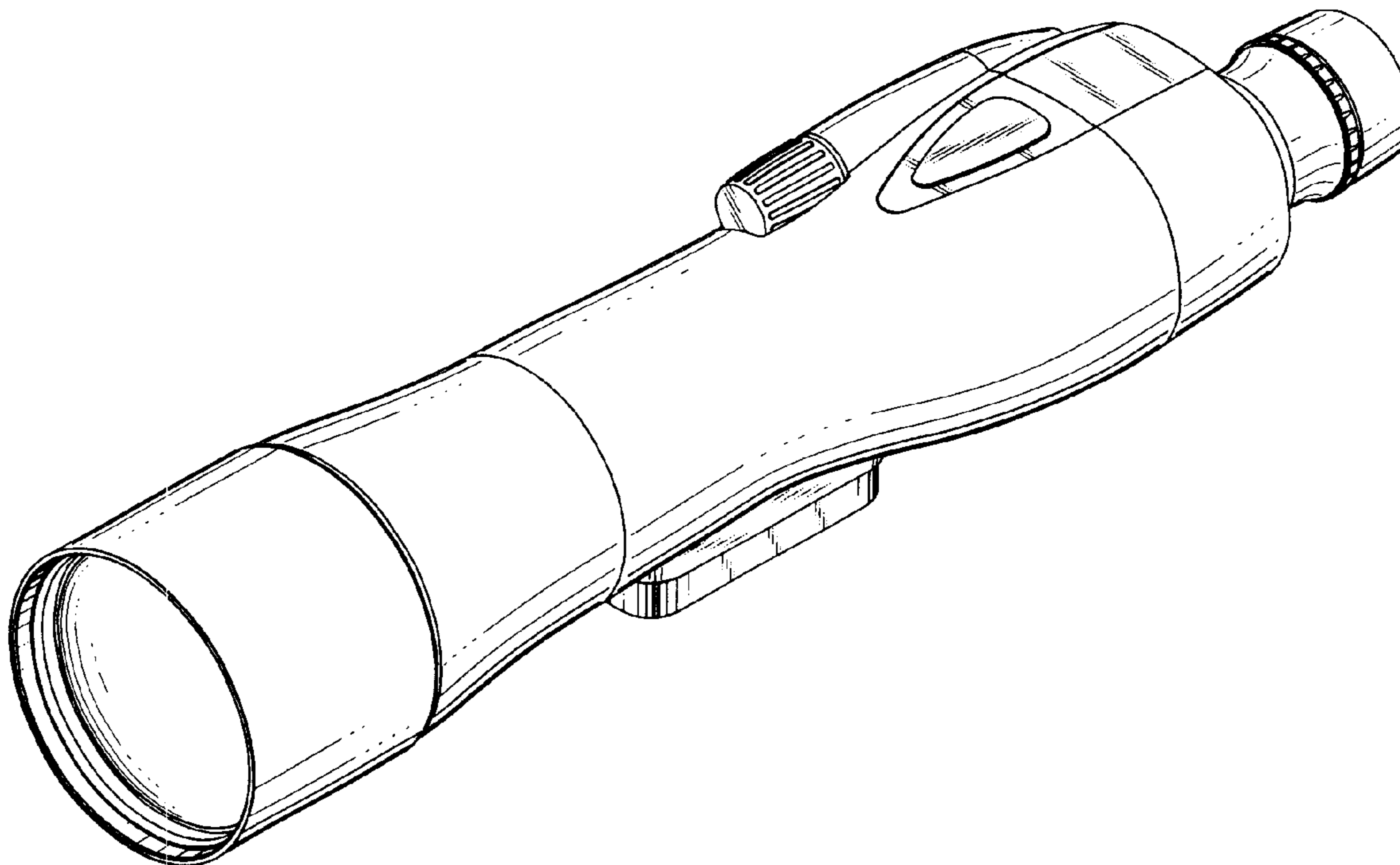

FIG. 1

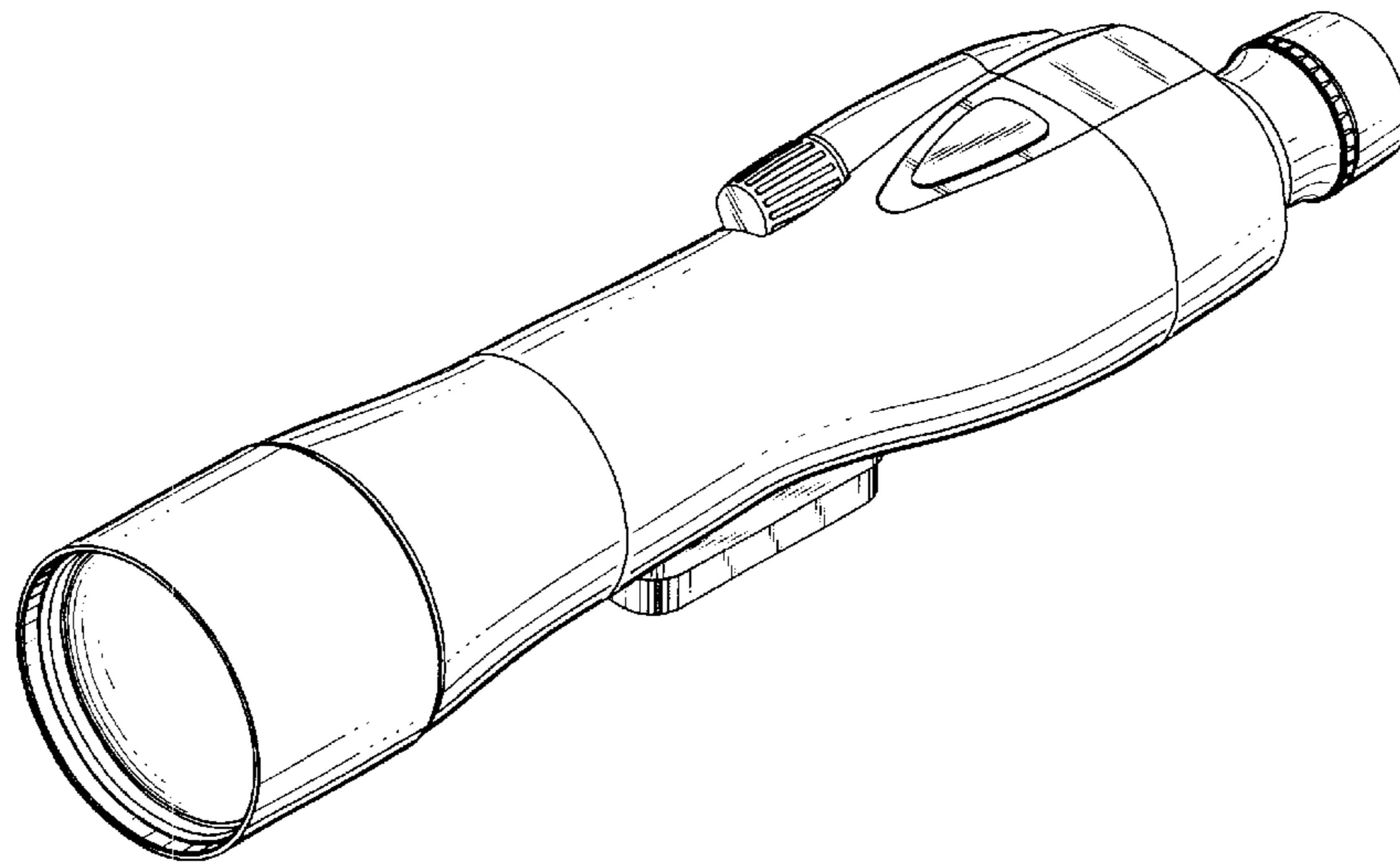

FIG. 2

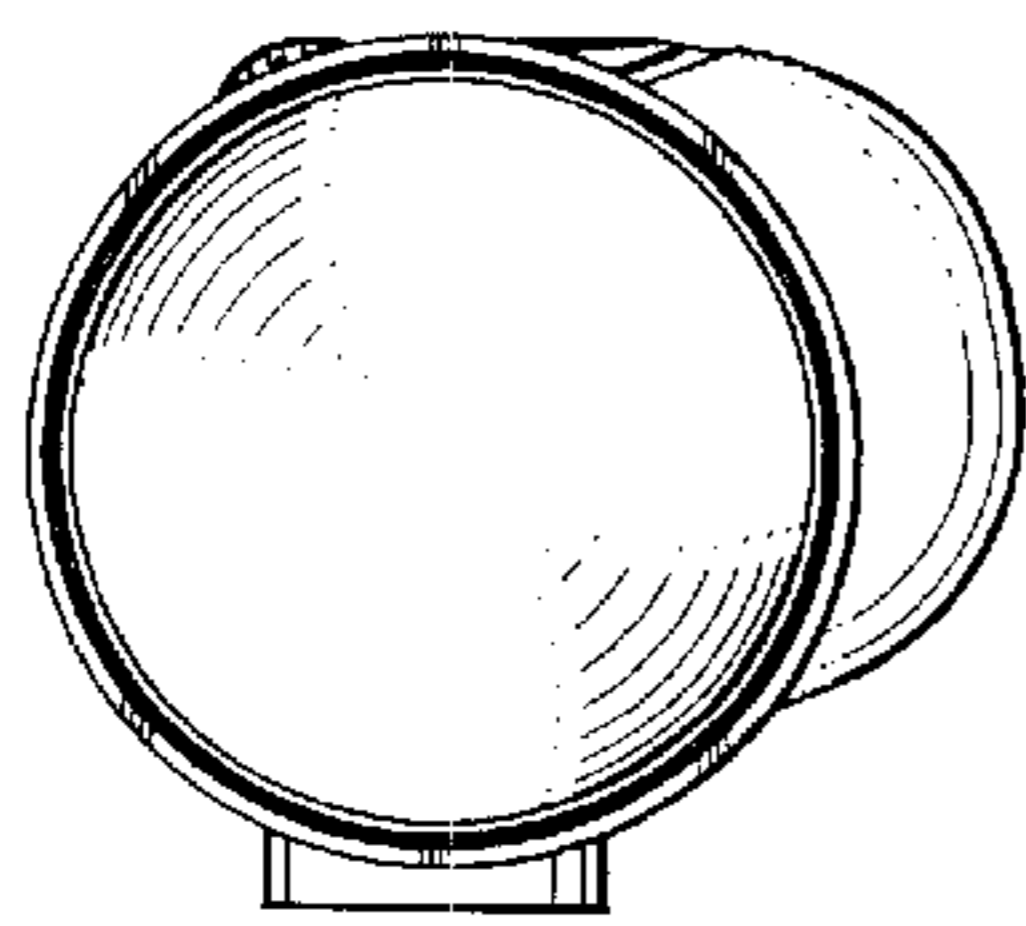

FIG. 3

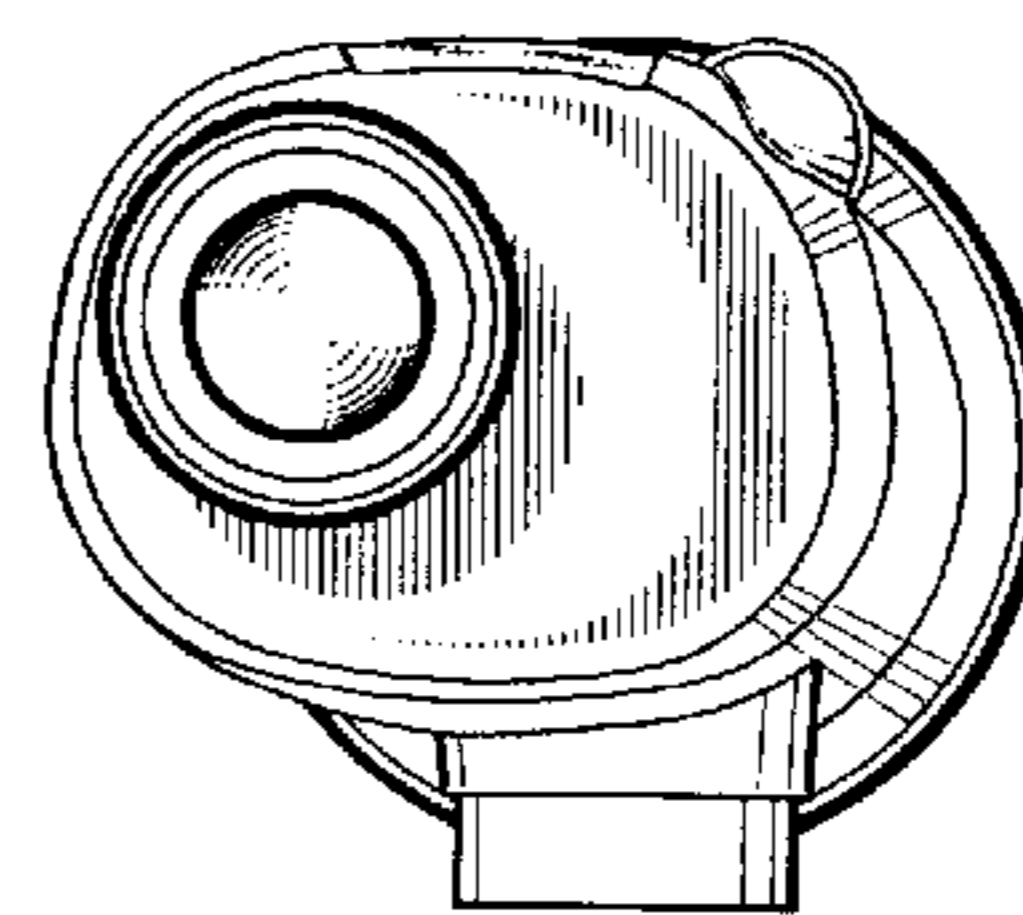

FIG. 4

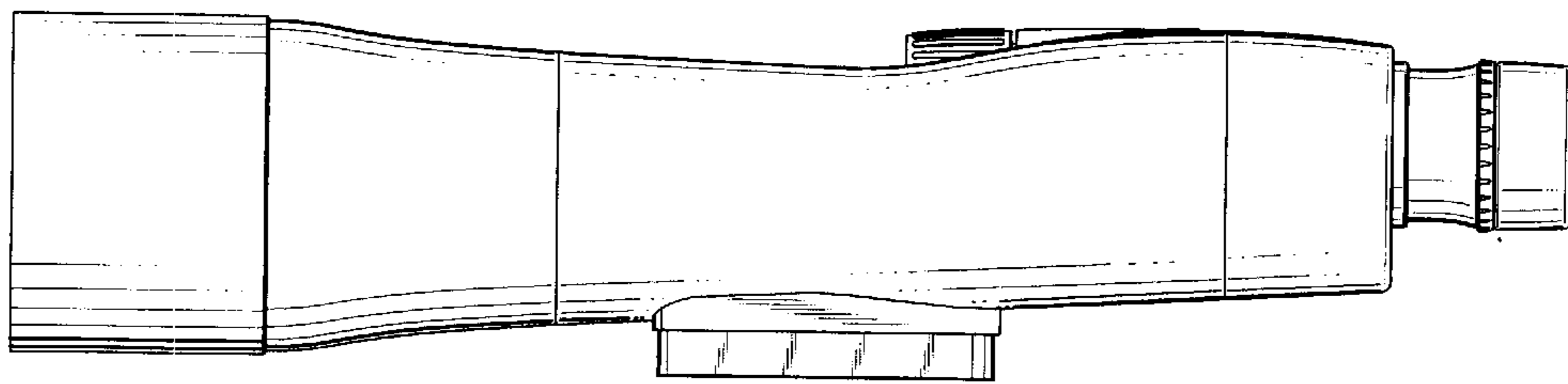

FIG. 5

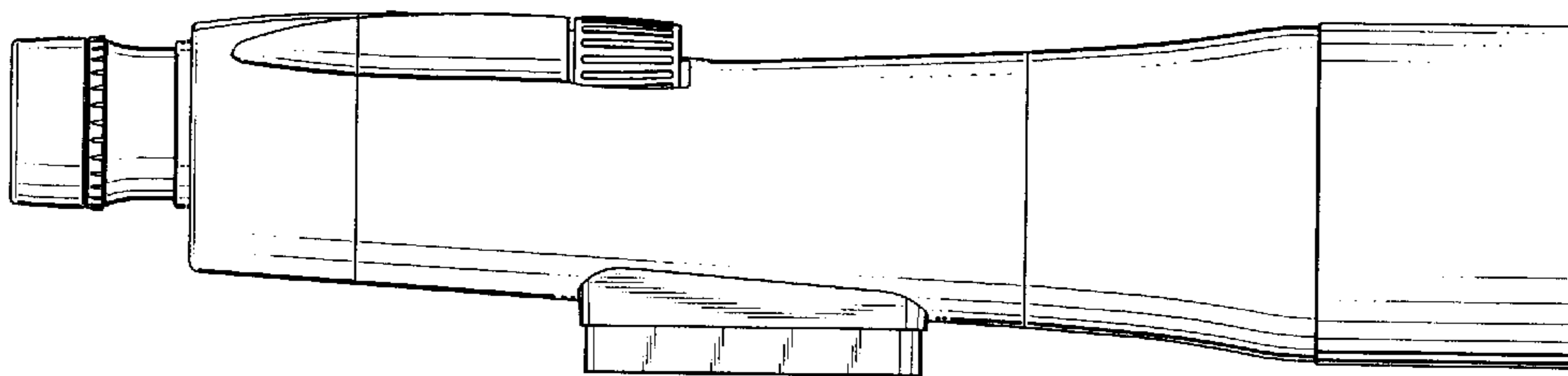

FIG. 6

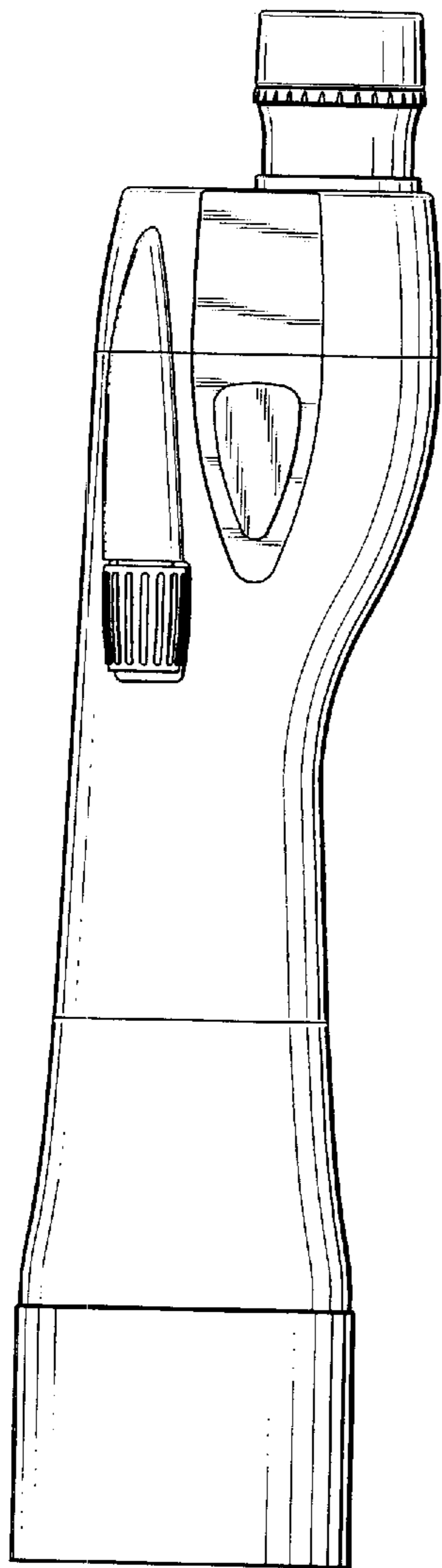

FIG. 7

